



# A3 MFPs Range Brochure

Document Solutions

[www.sharp.eu](http://www.sharp.eu)

**SHARP**  
Be Original.



# All you need to do more.

Getting things done fast shouldn't mean compromising on quality. These next generation MFPs give you the smart technology that helps you work more efficiently.

Sharp technology transforms the way organisations create, engage with and share information. Our industry-leading colour and black & white Multi-Function Printers (MFPs) all offer the same intuitive ease-of-use and smart app connectivity, as well as trusted security and enhanced productivity tools, to simplify the way you work.

These devices act as a secure information hub within small and medium sized businesses (SMBs) or medium sized workgroups in large organisations. An advanced range of smart functionality help you work more productively.

The Application Portal provides software updates and cloud connector apps that ensure your MFPs are always up-to-date. And there's plenty of flexibility for tailoring their features to suit both the way you work and your budget.

So, whatever you're doing, whether it's producing meeting materials, printing reports, scanning documents or securely sharing key information, you can do it all with outstanding speed and simplicity, even when you're on the move. And their futureproof technology means that our A3 digital MFPs will be a trusted resource for today, and tomorrow.



## Sharp's range of A3 colour and black & white MFPs transform the way you work.

**Advanced range** - 30 to 60ppm smart MFPs that meet the needs of even the most demanding environments.

**Essential range** - 26 to 60ppm affordable MFPs with vital productivity features and scalable functionality.



### Colour MFPs

#### Advanced (DSPF\*1)

MX-6071  
MX-5071  
MX-4071  
MX-3571  
MX-3071

#### Advanced (RSPF\*2)

MX-4061  
MX-3561  
MX-3061

#### Essential

MX-6051  
MX-5051  
MX-4051  
MX-3551  
MX-3051  
MX-2651

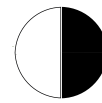

### Black & White MFPs

#### Advanced

MX-M6071  
MX-M5071  
MX-M4071  
MX-M3571  
MX-M3071

#### Essential

MX-M6051  
MX-M5051  
MX-M4051  
MX-M3551  
MX-M3051  
MX-M2651



# Keeping you safe.

Information is the life-blood of an organisation. That's why the most stringent protection is included as standard.

## Always on guard

The system at the heart of your MFP can become corrupted if an update fails or if it's the target of a malicious attack. So, these next generation MFPs include an innovative Self-Healing feature. A master copy of the MFP settings is backed up and can be used to safely recover the device if there ever is a problem. It also avoids any disruption to your business and ensures that valuable information and intellectual property is robustly protected.

## Instant validation

Information that is exchanged between an MFP and another application or email system can be intercepted or compromised. These MFPs provide the same high-level protection used by many government organisations. Their SSL/TLS Certificate Validation automatically checks that all third-party servers communicating with your MFP are safe, in order to prevent any unauthorised or malicious attempts to access your information.

## Proactive access control

To prevent any unauthorised use, these MFPs automatically monitor access attempts and only grant access to applications and operating firmware that are on an approved whitelist. Any other external applications are instantly blocked, logged and reported.

## Military-grade protection

Having been validated by the Protection Profile for Hardcopy Devices (HCD-PP v1.0) these MFPs provide the most advanced level of security demanded by business, government and military organisations. So, you can confidently handle the most sensitive data knowing that your MFP is incredibly secure.

## Safer email communication

Any documents you email directly from the MFP are encrypted using the S/MIME standard. It ensures they can't be intercepted during transmission and are validated as authentic using advanced electronic signatures.



# Work your own way.

Being able to work flexibly, at anytime and anywhere, is key to squeezing the maximum value out of every day.

With these next generation MFPs you don't need to waste time learning complex technology. Their smart usability and intelligent connectivity mean you can print, copy, scan and share the information you need quickly and securely wherever you're working. And their software is continually updated to ensure a futureproofed performance.

## One simple sign on

No one enjoys having to remember additional usernames and passwords. Instead, Single Sign On (SSO) is a smarter way to access public cloud services. It lets you securely print and store information in the cloud\*<sup>1</sup> using Google Drive™, OneDrive® for Business, SharePoint® Online, Box, Dropbox and Cloud Portal Office with just one simple log in from the control panel. There's also an integrated Gmail connector for scanning to email and Exchange Online (MS 365 email).



Insert your USB stick and start printing.

## Connections made easy

What could be easier than walking up to your MFP and printing whatever you want without even logging into your PC? With Sharp's Office Direct Print that's exactly what you get. Simply insert a USB memory stick in the MFP and immediately access and print images and Microsoft Office\*<sup>2</sup> files. You can also scan and save documents straight to the USB stick.

For even greater flexibility, you can wirelessly print\*<sup>3</sup> from any WiFi enabled laptop, tablet or smartphone without the need to set up a wireless LAN. It allows you to use a much broader range of devices in a wider variety of business environments.

And if you operate separate networks in the same workplace, which might have different security or usage restrictions, everyone can still share the same Sharp MFP for a more integrated way of working. These MFPs support dual LANs\*<sup>4</sup> that can be connected to two different networks, one of which could be wireless.

## Made for mobility

You'll love how fast and hassle-free printing from a mobile device is. You can link to the MFP in seconds by simply holding it over the NFC card reader\*<sup>5</sup> or by scanning the MFP's QR code\*<sup>6</sup>. Either way, these smart MFPs configure everything for you.

You can then print from and scan to mobiles and tablets over your wireless network using Sharpdesk Mobile or print from any app that supports Google Cloud Print™ or any Android device with the Sharp Print Service Plugin.



### Print where you like

Worried about leaving important or sensitive documents out in the open? Not with the Print Release feature. Simply send a job to print and then, whenever you are ready, just walk over to the most convenient MFP, log on and print off your information\*7.

### Simpler to manage

Printing or receiving information directly from your business systems and cloud-based applications is made much simpler with Sharp OSA® (Open System Architecture)\*8.

And the Application Centre Portal makes the MFP more adaptable by providing software updates and cloud connector apps that enable agile updating.



Release print jobs from the most convenient MFP.

\*1 Essential MFPs require optional MX-AMX2. \*2 Essential MFPs require optional MX-PU10. \*3 Essential MFPs require optional MX-EB18. \*4 Requires commercially available dual LAN adapter. \*5 For Android devices. Essential MFPs require commercially available NFC card reader. \*6 For both iOS and Android devices. \*7 Can be used from any of five network-connected MFPs. Essential Black & White MFPs require optional MX-HD16 to be the primary device. \*8 Essential MFPs require optional MX-AMX1, MX-AMX2 and MX-AMX3.

# Designed to perform.

These MFPs help you to achieve much more without working harder.

## Fast printing

Speeds range from 26 up to 60 pages per minute (ppm) on a variety of paper sizes up to SRA3\*<sup>1</sup> and weights up to 300gsm. A flashing LED\*<sup>2</sup> notifies you if any original documents are left behind, helping you to keep documents secure. And a range of paper handling and finishing options means there's an MFP to suit your needs.



Flashing light reminds users to remove original documents.

## Convenient scanning

Rather than having to retype documents you only have as hard copy, you can use Optical Character Recognition\*<sup>3</sup> (OCR) to scan them in various formats, including fully searchable PDFs and editable Microsoft® Office files.

## Easy to use

A tiltable, large 10.1" LCD touchscreen control panel with a consistent user interface across the complete range of MFPs provides easy access to commonly used functions via Easy Mode. Or you can customise it simply by dragging and dropping menu icons.



Tilt the panel to improve viewing angle.





### Efficient storage

A large 500GB onboard Hard Disk Drive\*<sup>4</sup> (HDD) and a Document Filing\*<sup>4</sup> feature enable fast and hassle-free printing and scanning.

### Consistent quality

Text and graphics on documents from any application are accurately reproduced using Adobe PostScript 3\*<sup>5</sup>, an image density sensor maintains a consistent image quality from first page to the last and our colour devices use PANTONE® technology to give you reliably accurate colours. The Auto Set function also adjusts the scanning settings to optimise the resolution, page size and orientation.

### Optimised direct PDF printing

Adobe Embedded Printer Engine (AEPE) enhances printing for the technology driven workplace. It helps to deliver up to 80% faster printing from mobile, cloud and USB.

### Always ready

A built-in Motion Sensor\*<sup>6</sup> intelligently detects an approaching user and instantly wakes the MFP from sleep mode. And, as no one likes interruptions, a continuous run feature\*<sup>7</sup> lets you top up the toner without pausing copy/print jobs to maintain productivity and reduce any downtime.

### Extra savings

The toner cartridge automatically ejects\*<sup>8</sup> only when the toner has been fully exhausted, saving toner, minimising waste and supporting environmental goals.

### Simple management

Check the status of the MFP with just a quick glance at the lights of the Status Communication Bar.



Distinct light patterns indicate specific MFP functions.

\*<sup>1</sup> Colour MFPs only. Maximum paper size on Black & White MFPs is A3W. \*<sup>2</sup> Advanced MFPs only excluding MX-4061/MX-3561/MX-3061. \*<sup>3</sup> Essential MFPs require optional MX-EB20. \*<sup>4</sup> Essential Black & White MFPs require optional MX-HD16. \*<sup>5</sup> Essential MFPs require optional MX-PK13.

\*<sup>6</sup> Advanced MFPs only. \*<sup>7</sup> MX-6071/MX-5071/MX-6051/MX-5051 only. \*<sup>8</sup> Colour MFPs only.

*Smart technology meets  
forward-thinking connectivity.  
Helping your teams become  
more efficient, and more effective.*

# More ways to save.

Our MFPs are designed to help you save time and money by optimising everyday tasks.

## Even more flexibility

Give your documents a truly professional look with a wide variety of finishing options, including punch, saddle stitching, stapleless stapling and a job separator. Additional capacity paper drawers can also be added to handle the demands of even the busiest office.

## Much less energy

Sharp MFPs are designed to work extremely efficiently so that you save on running costs. Automatic, configurable power settings ensure that the MFP only switches on during set hours. Our low-melt toner reduces the energy consumption on every print or copy run. And before starting each job, the control panel prompts you to choose the most environmentally friendly settings – such as Eco Scan, which prevents unnecessary functions from powering up in the background.



Flexible finishing and paper capacity options to suit your needs.



# Strengthen your business.

Improve security, increase efficiency and reduce your costs with our suite of Optimised Software Solutions.

We've spent years innovating and working to give you the best possible business solutions. From improving productivity and helping collaboration to ensuring connectivity and reducing waste, whatever your challenges are we've got a way to help you.

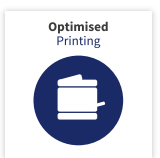

### Optimised Printing Solutions

Monitor, manage and secure your print, scan and copy jobs, ensure only authorised usage, track and recover costs, and reduce waste.

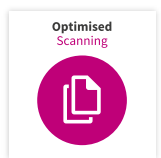

### Optimised Scanning Solutions

Save time and avoid costly errors by simplifying and automating how you capture, share and store documents – whatever their format.

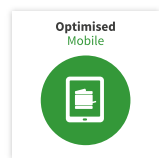

### Optimised Mobile Solutions

Create a more flexible team by connecting smartphones and tablets simply and securely, so they're always in touch.

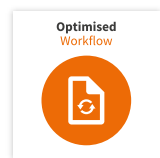

### Optimised Workflow Solutions

Maintain productivity and profitable growth by streamlining and simplifying repetitive tasks and connecting to line of business applications.

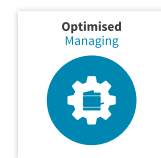

### Optimised Managing Solutions

Ease the burden of managing your MFPs/ Printers and build a consistent Print Security policy.

## Colour MFPs



### Advanced (DSPF)

### Advanced (RSPF)

### Essential

MX-6071  
MX-5071

MX-4071  
MX-3571  
MX-3071

MX-4061  
MX-3561  
MX-3061

MX-6051  
MX-5051

MX-4051  
MX-3551  
MX-3051  
MX-2651

#### General

	MX-6071 MX-5071	MX-4071 MX-3571 MX-3071	MX-4061 MX-3561 MX-3061	MX-6051 MX-5051	MX-4051 MX-3551 MX-3051 MX-2651
Speed (ppm)	60, 50	40, 35, 30	40, 35, 30	60, 50	40, 35, 30, 26
Paper Size (max)	SRA3	SRA3	SRA3	SRA3	SRA3
Motion Sensor	✓	✓	✓	✗	✗
Memory (GB)	✓ 5	✓ 5	✓ 5	✓ 5	✓ 5
Hard Disk Drive (GB)	✓ 500	✓ 500	✓ 500	✓ 500	✓ 500
Document Filing	✓	✓	✓	✓	✓

#### Print

	1200 x 1200	1200 x 1200	1200 x 1200	1200 x 1200	600 x 600
Office Direct Print	✓	✓	✓	+	+
Print Release	✓	✓	✓	✓	✓
Adobe Embedded Printer Engine	✓	✓	✓	✓	✓
PCL	✓	✓	✓	✓	✓
Adobe PostScript 3	✓	✓	✓	+	+
Continuous Run	✓	✗	✗	✓	✗

#### Scan & Fax

Optical Character Recognition	✓	✓	✓	+	+
Auto Set	✓	✓	✓	+*2	+*2
Fax	+	+	+	+	+

#### Media Handling

	650 - 6300	650 - 6300	650 - 6300	650 - 6300	650 - 6300
DSPF (150-sheet)	✓	✓	✗	✗	✗
RSPF (100-sheet)	✗	✗	✓	✓	✓
Stapleless Stapling	+	+	+	+	+
Manual Stapling	+	+	+	+	+
Saddle Stitching	+	+	+	+	+

#### Connectivity

Wireless LAN	✓	✓	✓	+	+
NFC	✓	✓	✓	+	+
Sharpdesk Mobile	✓	✓	✓	✓	✓
Sharp Print Service Plugin	✓	✓	✓	+	+
AirPrint	✓	✓	✓	+	+
Google Cloud Print	✓	✓	✓	+	+
Single Sign-On	✓	✓	✓	+	+
Cloud Portal Office	✓	✓	✓	+	+
Microsoft Exchange	✓	✓	✓	✓	✓
Gmail	✓	✓	✓	✓	✓
Google Drive	✓	✓	✓	+	+
SharePoint Online/OneDrive	✓	✓	✓	+	+
box	✓	✓	✓	+	+
Dropbox	✓	✓	✓	+	+
Sharp OSA	✓	✓	✓	+	+

#### Security

Data Security Kit	+	+	+	+	+
-------------------	---	---	---	---	---

✓ Standard    + Optional    ✗ Not available

# Black & White MFPs

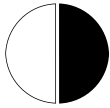

## Advanced

## Essential

MX-M6071  
MX-M5071

MX-M4071  
MX-M3571  
MX-M3071

MX-M6051  
MX-M5051

MX-M4051  
MX-M3551  
MX-M3051  
MX-M2651

### General

	MX-M6071 MX-M5071	MX-M4071 MX-M3571 MX-M3071	MX-M6051 MX-M5051	MX-M4051 MX-M3551 MX-M3051 MX-M2651
Speed (ppm)	60, 50	40, 35, 30	60, 50	40, 35, 30, 26
Paper Size (max)	A3W	A3W	A3W	A3W
Motion Sensor	✓	✓	✗	✗
Memory (GB)	✓ 5	✓ 5	✓ 5	✓ 5
Hard Disk Drive (GB)	✓ 500	✓ 500	⊕ 500	⊕ 500
Document Filing	✓	✓	⊕	⊕

### Print

	MX-M6071 MX-M5071	MX-M4071 MX-M3571 MX-M3071	MX-M6051 MX-M5051	MX-M4051 MX-M3551 MX-M3051 MX-M2651
Resolution (dpi)	1200 x 1200	1200 x 1200	600 x 600	600 x 600
Office Direct Print	✓	✓	⊕	⊕
Print Release	✓	✓	⊕ *1	⊕ *1
Adobe Embedded Printer Engine	✓	✓	✓	✓
PCL	✓	✓	✓	✓
Adobe PostScript 3	✓	✓	⊕	⊕
Continuous Run	✗	✗	✗	✗

### Scan & Fax

Optical Character Recognition	✓	✓	⊕	⊕
Auto Set	✓	✓	⊕ *2	⊕ *2
Fax	⊕	⊕	⊕	⊕

### Media Handling

Paper Capacity	650 - 6300	650 - 6300	650 - 6300	650 - 6300
DSPF (150-sheet)	✓	✓	✗	✗
RSPF (100-sheet)	✗	✗	✓	✓
Stapleless Stapling	⊕	⊕	⊕	⊕
Manual Stapling	⊕	⊕	⊕	⊕
Saddle Stitching	⊕	⊕	⊕	⊕

### Connectivity

Wireless LAN	✓	✓	⊕	⊕
NFC	✓	✓	⊕	⊕
Sharpdesk Mobile	✓	✓	✓	✓
Sharp Print Service Plugin	✓	✓	⊕	⊕
AirPrint	✓	✓	⊕	⊕
Google Cloud Print	✓	✓	⊕	⊕
Single Sign-On	✓	✓	⊕	⊕
Cloud Portal Office	✓	✓	⊕	⊕
Microsoft Exchange	✓	✓	✓	✓
Gmail	✓	✓	✓	✓
Google Drive	✓	✓	⊕	⊕
SharePoint Online/OneDrive	✓	✓	⊕	⊕
box	✓	✓	⊕	⊕
Dropbox	✓	✓	⊕	⊕
Sharp OSA	✓	✓	⊕	⊕

### Security

Data Security Kit	⊕	⊕	⊕	⊕
-------------------	---	---	---	---

\*1 Requires optional MX-HD16 to be the primary device. Can be used as secondary device as standard. \*2 Some features require optional MX-EB20.

# Configurations

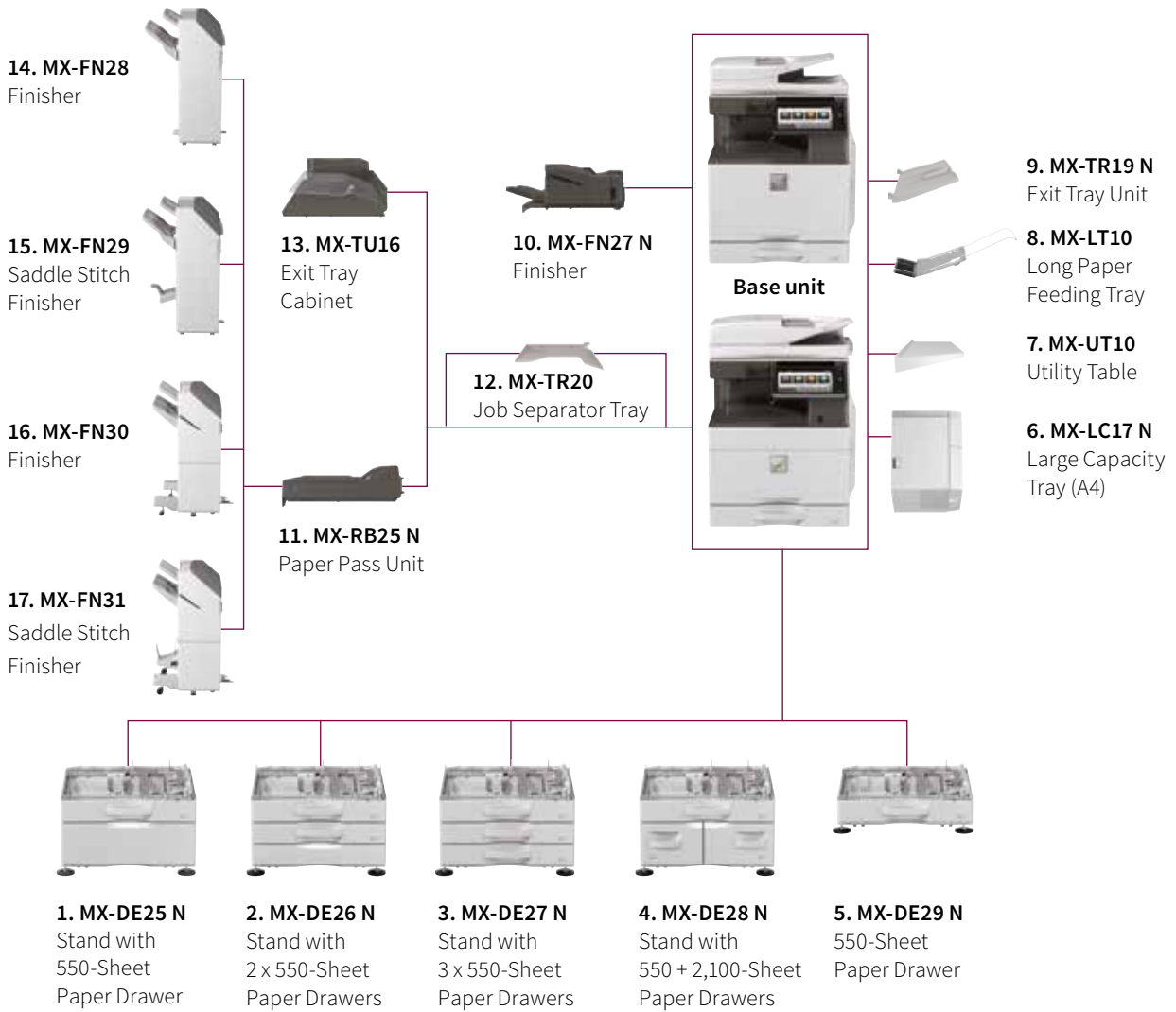

# Dimensions

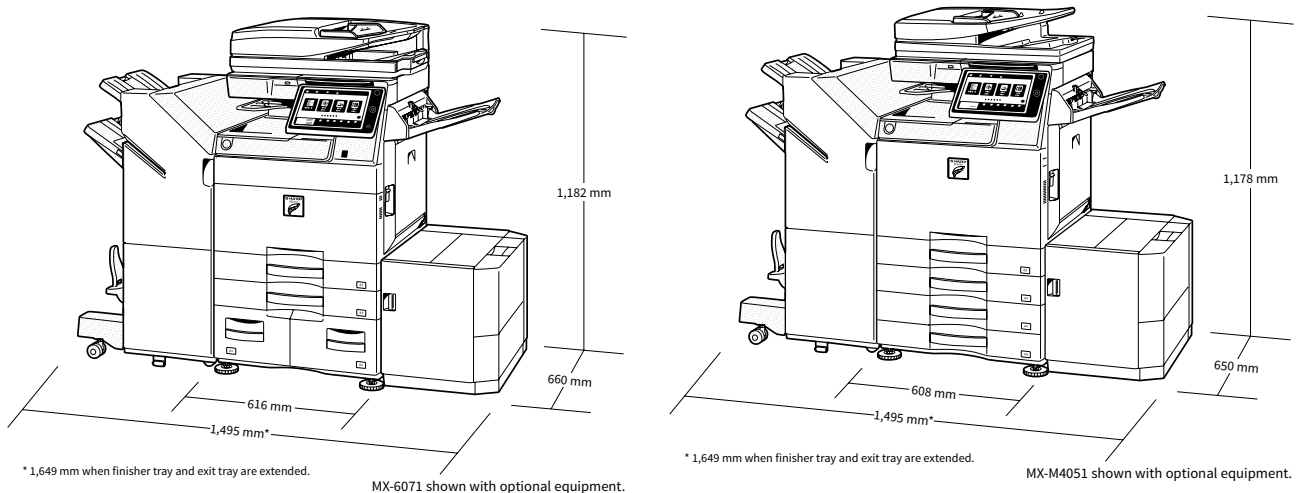

# Options

## Base unit

### 1. MX-DE25 N Stand with 550-Sheet Paper Drawer

550 sheets\*<sup>1</sup>, SRA3\*/A3W\*<sup>3</sup> - A5R (60 - 300 g/m<sup>2</sup>)

### 2. MX-DE26 N Stand with 2 x 550-Sheet Paper Drawer

550 sheets\*<sup>1</sup> each for lower and upper trays, SRA3\*/A3W\*<sup>3</sup> - A5R (60 - 300 g/m<sup>2</sup>)

### 3. MX-DE27 N Stand with 3 x 550-Sheet Paper Drawer

550 sheets\*<sup>1</sup> each for lower and upper trays, SRA3\*/A3W\*<sup>3</sup> - A5R (60 - 300 g/m<sup>2</sup>)

### 4. MX-DE28 N Stand with 550 + 2,100-Sheet Paper Drawer

Upper tray: SRA3\*/A3W\*<sup>3</sup> - A5R, 550 sheets\*<sup>1</sup> (60 - 300 g/m<sup>2</sup>).

Lower tray (Left): A4, 1,200 sheets\*<sup>1</sup> (60 - 105 g/m<sup>2</sup>)

Lower tray (Right): A4 - B5, 900 sheets\*<sup>1</sup> (60 - 105 g/m<sup>2</sup>)

### 5. MX-DE29 N 550-Sheet Paper Drawer

550 sheets\*<sup>1</sup>, SRA3\*/A3W\*<sup>3</sup> - A5R (60 - 300 g/m<sup>2</sup>)

### 6. MX-LC17 N Large Capacity Tray (A4)

3,000 sheets\*<sup>1</sup>, A4 - B5 (60 - 220 g/m<sup>2</sup>)

### 7. MX-UT10 Utility Table

## Finishing

### 8. MX-LT10 Long Paper Feeding Tray

Recommended for banner printing

### 9. MX-TR19 N Exit Tray Unit

#### Optional Punch Module for MX-FN27 N:

##### MX-PN14C - 2/4 Hole Punch Module

##### MX-PN14D - 4 Hole Wide Punch Module

### 10. MX-FN27 N Inner Finisher

A3 - B5 (offset/staple), SRA3\*/A3W\*<sup>3</sup> - A5R (non offset)

Offset tray (upper): max. 500-sheet paper capacity\*<sup>1</sup>

Stapling capacity: max. 50-sheet multi-position staple\*<sup>1</sup>

Staple position: 3 locations (front, rear or 2 point stitching)

Manual Stapling: 1-point at rear (Flat), 45 sheets (64 g/m<sup>2</sup>), 40 sheets (80 g/m<sup>2</sup>)

Stapleless capacity: max.5-sheet (64 g/m<sup>2</sup>), 4 sheet (65 - 81.4 g/m<sup>2</sup>),

3 sheet (81.5 - 105 g/m<sup>2</sup>)

Stapleless position: 1-point at rear (Slant), A3 - B5

### 11. MX-RB25 N Paper Pass Unit

Required when using MX-FN28, MX-FN29, MX-FN30 & MX-FN31

### 12. MX-TR20 Job Separator Tray

Requires MX-TU16 Exit Tray Cabinet

### 13. MX-TU16 Exit Tray Cabinet

#### Optional Punch Module for MX-FN28 & MX-FN29:

##### MX-PN15C - 2/4 Hole Punch Module

##### MX-PN15D - 4 Hole Wide Punch Module

### 14. MX-FN28 1k Finisher

A3W - A5R (offset/staple), SRA3\*/A3W\*<sup>3</sup> - A5R (non offset)

Offset tray (upper): max.1,000-sheet paper capacity\*<sup>1</sup>

Stapling capacity: max. 50-sheet multi-position staple\*<sup>1</sup>

Staple position: 1-point at front (Flat), 1-point at back (Flat), 2 point stitching

### 15. MX-FN29 1k Saddle Stitch Finisher

A3W - A5R (offset/staple), SRA3\*/A3W\*<sup>3</sup> - A5R (non offset)

Offset tray (upper): max.1,000-sheet paper capacity\*<sup>1</sup>

Stapling capacity: max. 50-sheet multi-position staple\*<sup>1</sup>

Staple position: 1-point at front (Flat), 1-point at back (Flat), 2 point stitching

Saddle stitch tray (lower): 7 sets (11-15 sheets), 10 sets (6-10 sheets),

20 sets (1-5 sheets). 15 sheets max per set

#### Optional Punch Module for MX-FN30 & MX-FN31:

##### MX-PN16C - 2/4 Hole Punch Module

##### MX-PN16D - 4 Hole Wide Punch Module

### 16. MX-FN30 3k Finisher

A3 - B5 (offset/staple), SRA3\*/A3W\*<sup>3</sup> - A5R (non offset)

Offset tray (upper): max.3,000-sheet paper capacity\*<sup>1</sup>

Stapling capacity: max. 65-sheet multi-position staple\*<sup>1</sup>

Staple position: 1-point at front (Slant), 1-point at back (Slant), 2 point stitching

Manual Stapling: 1-point at rear (Flat), 45 sheets (64 g/m<sup>2</sup>), 40 sheets (80 g/m<sup>2</sup>)

Stapleless capacity: max.5-sheet (64 g/m<sup>2</sup>), 4 sheet (65 - 81.4 g/m<sup>2</sup>),

3 sheet (81.5 - 105 g/m<sup>2</sup>)

Stapleless position: 1-point at rear (Slant), A3 - B5

### 17. MX-FN31 3k Saddle Stitch Finisher

A3 - B5 (offset/staple), SRA3\*/A3W\*<sup>3</sup> - A5R (non offset)

Offset tray (upper): max.3,000-sheet paper capacity\*<sup>1</sup>

Stapling capacity: max. 65-sheet multi-position staple\*<sup>1</sup>

Staple position: 1-point at front (Slant), 1-point at back (Slant), 2 point stitching

Manual Stapling: 1-point at rear (Flat), 45 sheets (64 g/m<sup>2</sup>), 40 sheets (80 g/m<sup>2</sup>)

Stapleless capacity: max.5-sheet (64 g/m<sup>2</sup>), 4 sheet (65 - 81.4 g/m<sup>2</sup>),

3 sheet (81.5 - 105 g/m<sup>2</sup>)

Stapleless position: 1-point at rear (Slant), A3 - B5

Saddle stitch tray (lower): 10 sets (11-15 sheets), 15 sets (6-10 sheets),

25 sets (1-5 sheets). 20 sheets max per set

## Printing

### MX-PK13 PS3 Expansion Kit\*<sup>4</sup>

Adobe PostScript®3™ expansion kit

### MX-PU10 Direct Print Expansion Kit\*<sup>4</sup>

Direct print Microsoft® Office files from USB drives

### MX-PF10 Barcode Font Kit

Enables barcode printing

### MX-HD16 Hard Disk Expansion Kit\*<sup>5</sup>

## Faxing

### MX-FX15 Fax Expansion Kit

### MX-FWX1 Internet Fax Expansion Kit

## Connectivity

### MX-EB18 Wireless LAN Adaptor\*<sup>4</sup>

Enables connection to wireless networks

## Scanning

### MX-EB19 Enhanced Compression Kit\*<sup>4</sup>

Enables creation of high compression PDFs

### MX-EB20 OCR Expansion Kit\*<sup>4</sup>

Convert scanned documents into editable Microsoft® Office files and searchable PDFs via Optical Character Recognition (OCR)

### AR-SU1 Stamp Unit

Marks already scanned documents for checking

## Sharpdesk Licenses

### MX-USX1/X5

1/5-License Kit

### MX-US10/50/A0

10/50/100-License Kit

## Sharp OSA®

### MX-AMX1 Application Integration Module

### MX-AMX2 Application Communication Module\*<sup>4</sup>

### MX-AMX3 External Account Module\*<sup>4</sup>

## Security

### MX-FR62U Data Security Kit\*<sup>2</sup>

### MX-FR64U Data Security Kit\*<sup>3</sup>

\*<sup>1</sup> Number of sheets based on 80 g/m<sup>2</sup>. \*<sup>2</sup> Colour MFPs only. \*<sup>3</sup> Black & White MFPs only. \*<sup>4</sup> Essential MFPs only. \*<sup>5</sup> Essential Black & White MFPs only.

# Welcome to Sharp

Sharp Information Systems Europe (SISE), a division of Sharp Electronics Europe, offers a comprehensive portfolio of award-winning document management and display solutions to help organisations transform the way they engage with information. Sharp's industry-leading MFPs and high-volume systems sit at the heart of integrated applications for digital transformation.

Sharp's proprietary Open Systems Architecture (OSA) technology transforms MFPs into powerful information portals, seamlessly integrating to the cloud and third-party business applications. Sharp Cloud Portal Office is an award winning document management and collaboration system designed to help small- to medium-sized businesses drive growth, improve efficiency and reduce costs. By facilitating the transition to new equipment, methods and processes, Sharp Optimised Managed Services help improve how businesses interact with information through enhanced digital workflows and more collaborative working.

Sharp also offer a range of display solutions that include video walls for immersive entertainment, digital signage and innovative interactive touchscreens for engaging presentations.

Our mission is to develop new products that support individual expression; creating life enhancing experiences that let you be original.



Design and specifications are subject to change without prior notice. All information was correct at time of print. Microsoft, Excel, PowerPoint, OneDrive, SharePoint, Active Directory, Windows Server, and Windows are either registered trademarks or trademarks of Microsoft Corporation in the US and/or other countries. Adobe and PostScript 3 are either registered trademarks or trademarks of Adobe Systems Incorporated in the US and/or other countries. Google Drive, Gmail, Android, and Google Cloud Print are trademarks of Google LLC. The Google Drive trademark is used with permission from Google LLC. Box is a trademark, service mark, or registered trademark of Box, Inc. QR Code is a registered trademark of DENSO WAVE INCORPORATED in Japan and other countries. AirPrint and Mac are trademarks of Apple Inc., registered in the US and other countries. PCL is a registered trademark of Hewlett-Packard Company. Qualcomm DirectOffice is a product of Qualcomm Technologies, Inc. and/or its subsidiaries. Qualcomm is a trademark of Qualcomm Incorporated, registered in the US and other countries. DirectOffice is a trademark of CSR Imaging US, LP, registered in the US and other countries. All other company names, product names and logotypes are trademarks or registered trademarks of their respective owners. ©Sharp Corporation November 2019. Ref: A3 Range Brochure (Job 20115). All trademarks acknowledged. E&O.