



DIGITAL FULL COLOUR MULTIFUNCTIONAL SYSTEM

Model: MX-6500N/MX-7500N

QUICK START GUIDE



BEFORE FIRST USE	2
INFORMATION ON DISPOSAL	4
CAUTIONS	5
OPERATION MANUALS AND HOW TO USE THEM	7
DOWNLOADING MANUAL	8
PART NAMES	11
TURNING THE POWER ON AND OFF	12
HOME SCREEN	13
MAINTENANCE	14
PRINTER	15
COPY	16
SCAN	18
DOCUMENT FILING	20
COPY OUTPUT	22
MANUAL FINISHING	24
SPECIFICATIONS	26
SUPPLIES	32
ADMINISTRATOR	33
SIZES AND TYPES PAPER THAT CAN BE SET IN EACH TRAY	34
TROUBLESHOOTING	36

Keep this manual close at hand for reference whenever needed.

BEFORE FIRST USE

Caution!

For complete electrical disconnection, pull out the main plug.
The socket-outlet shall be installed near the equipment and shall be easily accessible.

Shielded interface cables must be used with this equipment to maintain compliance with EMC regulations.

The equipment should be installed near an accessible socket outlet for easy disconnection.

Each instruction also covers the optional units used with these products.

EMC (this machine and peripheral devices)

WARNING:

This is a Class A product. In a domestic environment this product may cause radio interference in which case the user may be required to take adequate measures. This warning does not apply to the products for South Africa.

This machine contains the software having modules developed by Independent JPEG Group.

This product includes Adobe® Flash® technology of Adobe Systems Incorporated.

Copyright© 1995-2007 Adobe Macromedia Software LLC. All rights reserved.

This product includes the Adobe® PostScript®3™ of Adobe Systems Incorporated.

This product uses "InstantBoot" provided by IT Access Co., Ltd., Japan.

The machine includes the document filing function, which stores document image data on the machine's hard drive. Stored documents can be called up and printed or transmitted as needed. If a hard drive failure occurs, it will no longer be possible to call up the stored document data. To prevent the loss of important documents in the unlikely event of a hard drive failure, keep the originals of important documents or store the original data elsewhere.
With the exception of instances provided for by law, Sharp Corporation bears no responsibility for any damages or loss due to the loss of stored document data.

SOFTWARE LICENCE

The SOFTWARE LICENCE will appear when you install the software from the CD-ROM. By using all or any portion of the software on the CD-ROM or in the machine, you are agreeing to be bound by the terms of the SOFTWARE LICENCE.

The explanations in this manual are based on American English and the North American version of the software.

Software for other countries and regions may vary slightly from the North American version.



- The explanations in this manual assume that you have a working knowledge of your Windows or Macintosh computer.
- For information on your operating system, please refer to your operating system manual or the online Help function.
- The explanations of screens and procedures in this manual are primarily for Windows 7® in Windows® environments. The screens may vary depending on the version of the operating system.
- Considerable care has been taken in preparing this manual. If you have any comments or concerns about the manual, please contact your dealer or nearest authorised service representative.
- This product has undergone strict quality control and inspection procedures. In the unlikely event that a defect or other problem is discovered, please contact your dealer or nearest authorised service representative.
- Aside from instances provided for by law, SHARP is not responsible for failures occurring during the use of the product or its options, or failures due to incorrect operation of the product and its options, or other failures, or for any damage that occurs due to use of the product.



Products that have earned the ENERGY STAR® are designed to protect the environment through superior energy efficiency.
The products that meet the ENERGY STAR® guidelines carry the ENERGY STAR® logo.
The products without the logo may not meet the ENERGY STAR® guidelines.

Warranty

While every effort has been made to make this document as accurate and helpful as possible, SHARP Corporation makes no warranty of any kind with regard to its content. All information included herein is subject to change without notice. SHARP is not responsible for any loss or damages, direct or indirect, arising from or related to the use of this operation manual.

© Copyright SHARP Corporation 2013. All rights reserved. Reproduction, adaptation or translation without prior written permission is prohibited, except as allowed under copyright laws.

MATERIAL SAFETY DATA SHEET



The MSDS (Material Safety Data Sheet) can be viewed at the following URL address:

<http://www.sharp-world.com/corporate/info/index.html>.

For Sharp multifunctional devices/copiers/printers that have been awarded the German environmental label "Blue Angel" you can find more information on our homepage <http://www.sharp.de>.

Notice for users in the UK

MAINS PLUG WIRING INSTRUCTIONS

The mains lead of this equipment is already fitted with a mains plug which is either a non-rewireable (moulded) or a rewireable type. Should the fuse need to be replaced, a BSI or ASTA approved fuse to BS1362 marked  or  and of the same rating as the one removed from the plug must be used.

Always refit the fuse cover after replacing the fuse on the moulded plug. Never use the plug without the fuse cover fitted.

In the unlikely event of the socket outlet in your home not being compatible with the plug supplied either cut-off the moulded plug (if this type is fitted) or remove by undoing the screws if a rewireable plug is fitted and fit an appropriate type observing the wiring code below.

DANGER: The fuse should be removed from the cut-off plug and the plug destroyed immediately and disposed of in a safe manner. Under no circumstances should the cut-off plug be inserted elsewhere into a 13A socket outlet as a serious electric shock may occur.

To fit an appropriate plug to the mains lead, follow the instructions below:

IMPORTANT: The wires in this mains lead are coloured in accordance with the following code:

GREEN-AND-YELLOW:	Earth
BLUE:	Neutral
BROWN:	Live

As the colours of the wires in this mains lead may not correspond with coloured markings identifying the terminals in your plug, proceed as follows:

The wire which is coloured **GREEN-AND-YELLOW** must be connected to the terminal in the plug which is marked with the letter **E**, or by the safety earth symbol , or coloured green or greenand-yellow.

The wire which is coloured **BLUE** must be connected to the terminal which is marked with the letter **N** or coloured black.

The wire which is coloured **BROWN** must be connected to the terminal which is marked with the letter **L** or coloured red.

The wire which is coloured **BROWN** must be connected to the terminal which is marked with the letter **L** or coloured red.

If you have any doubt, consult a qualified electrician.

WARNING: THIS APPARATUS MUST BE EARTHED.

INFORMATION ON DISPOSAL

Information on Disposal for Users (private households)

■ In the European Union

Attention: If you want to dispose of this equipment, please do not use the ordinary dust bin! Used electrical and electronic equipment must be treated separately and in accordance with legislation that requires proper treatment, recovery and recycling of used electrical and electronic equipment. Following the implementation by member states, private households within the EU states may return their used electrical and electronic equipment to designated collection facilities free of charge*. In some countries* your local retailer may also take back your old product free of charge if you purchase a similar new one.

*) Please contact your local authority for further details. If your used electrical or electronic equipment has batteries or accumulators, please dispose of these separately beforehand according to local requirements. By disposing of this product correctly you will help ensure that the waste undergoes the necessary treatment, recovery and recycling and thus prevent potential negative effects on the environment and human health which could otherwise arise due to inappropriate waste handling.

■ In other Countries outside the EU

If you wish to discard this product, please contact your local authorities and ask for the correct method of disposal. For Switzerland: Used electrical or electronic equipment can be returned free of charge to the dealer, even if you don't purchase a new product. Further collection facilities are listed on the homepage of www.swico.ch or www.sens.ch.



Attention: Your product is marked with this symbol. It means that used electrical and electronic products should not be mixed with general household waste. There is a separate collection system for these products.

Information on Disposal for Business Users

■ In the European Union

If the product is used for business purposes and you want to discard it: Please contact your SHARP dealer who will inform you about the take-back of the product. You might be charged for the costs arising from take-back and recycling. Small products (and small amounts) might be taken back by your local collection facilities. For Spain: Please contact the established collection system or your local authority for take-back of your used products.

■ In other Countries outside the EU

If you wish to discard of this product, please contact your local authorities and ask for the correct method of disposal.

CAUTIONS

Symbols in this manual

To ensure safe use of the machine, this manual uses various safety symbols. The safety symbols are classified as explained below. Be sure you understand the meaning of the symbols when reading the manual.

Meaning of the symbols



CAUTION!
HOT



PINCH POINT
KEEP CLEAR



PROHIBITED
ACTIONS



DO NOT
DISASSEMBLE



MANDATORY
ACTIONS

WARNING

Indicates a risk of death or serious injury.

CAUTION

Indicates a risk of human injury or property damage.

Handling precautions

WARNING



If you notice smoke, a strange odor, or other abnormality, do not use the machine.

If used in this condition, fire or electrical shock may result. Immediately switch off the main power and remove the power plug from the power outlet. Contact your dealer or nearest authorised service representative.



Do not use a flammable spray to clean the machine.

If gas from the spray comes in contact with hot electrical components or the fusing unit inside the machine, fire or electrical shock may result.



Do not make any modifications to this machine.

Doing so may result in personal injury or damage to the machine.



Do not remove the machine casing.

High-voltage parts inside the machine may cause electrical shock.



Do not place a container of water or other liquid, or a metal object that might fall inside, on the machine.

If the liquid spills or the object falls into the machine, fire or electrical shock may result.



If a thunder storm begins, switch off the main power and remove the power plug from the outlet to prevent electrical shock and fire due to lightning.



Do not look directly at the light source.

Doing so may damage your eyes.



Do not block the ventilation ports on the machine. Do not install the machine in a location that will block the ventilation ports.

Blocking the ventilation ports will cause heat to build up in the machine, creating a risk of fire.



The fusing unit and paper exit area are hot. When removing a misfeed, do not touch the fusing unit and paper exit area. Take care not to burn yourself.

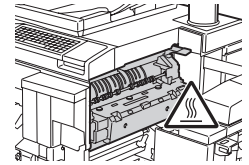

When loading paper, removing a misfeed, performing maintenance, closing the front and side covers, and inserting and removing trays, take care that your fingers are not pinched.

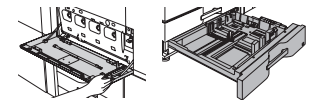

The machine includes the document filing function, which stores document image data on the machine's hard drive. Stored documents can be called up and printed or transmitted as needed. If a hard drive failure occurs, it will no longer be possible to call up the stored document data. To prevent the loss of important documents in the unlikely event of a hard drive failure, keep the originals of important documents or store the original data elsewhere. With the exception of instances provided for by law, Sharp Corporation bears no responsibility for any damages or loss due to the loss of stored document data.

Laser information

Wave length	788 nm + 12 nm / -13 nm
Pulse times	MX-6500N (330 mm/s): (3.773 μ s \pm 0.015 μ s) / 7 mm
	MX-7500N (360 mm/s): (3.458 μ s \pm 0.014 μ s) / 7 mm
	Heavy paper mode (220 mm/s): (5.659 μ s \pm 0.023 μ s) / 7 mm
Output power	Max 1.4 mW (LD1 + LD2 + LD3 + LD4)

Caution

Use of controls or adjustments or performance of procedures other than those specified herein may result in hazardous radiation exposure.

This Digital Equipment is CLASS 1 LASER PRODUCT (IEC 60825-1 Edition 2-2007)

Power notes

⚠ WARNING

- ⊘ Do not insert or remove the power plug with wet hands. This may cause electrical shock.
- ⊘ When removing the power plug from the outlet, do not pull on the cord. Pulling on the cord may cause damage such as wire exposure and breakage, and may result in fire or electrical shock.
- ⚠ If you will not use the machine for a long time, be sure to remove the power plug from the outlet for safety.
- ⚠ Be sure to connect the power cord only to a power outlet that meets the specified voltage and current requirements. Also make certain the outlet is properly grounded. Do not use an extension cord or adapter to connect other devices to the power outlet used by the machine. Using an improper power supply may cause fire or electrical shock.
* For the power supply requirements, see the name plate in the lower left corner of the left side of the machine.

Installation notes

⚠ WARNING

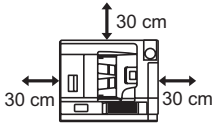
- ⊘ Do not install the machine on an unstable or slanted surface. Install the machine on a surface that can withstand the weight of the machine. Risk of injury due to the machine falling or toppling.
- ⊘ Be sure to connect the power cord only to a power outlet that meets the specified voltage and current requirements. Also make certain the outlet is properly grounded. Do not use an extension cord or adapter to connect other devices to the power outlet used by the machine. Using an improper power supply may cause fire or electrical shock.
* For the power supply requirements, see the name plate of each machines and devices.
- ⚠ Near a wall
Be sure to leave the clearances shown right between the unit and the nearest wall or other surface. For easy maintenance, you should also leave the clearances shown right around the unit.

- ⊘ Locations that are excessively hot, cold, humid, or dry. (near heaters, humidifiers, air conditioners, etc.) The paper will become damp and condensation may form inside the machine, causing misfeeds and dirty output.
- ⊘ Do not install the machine in a location with poor air circulation. A small amount of ozone is created inside the machine during printing. The amount of ozone created is not sufficient to be harmful; however, an unpleasant odor may be noticed during large copy runs, and thus the machine should be installed in a room with a ventilation fan or windows that provide sufficient air circulation. (The odor may occasionally cause headaches.)
- ⊘ Locations exposed to direct sunlight
Plastic parts may become deformed and dirty output may result.
- ⊘ Locations with ammonia gas
Installing the machine next to a diazo copy machine may cause dirty output.
- ⊘ Locations subject to vibration.
Vibration may cause failure.

⚠ CAUTION

The machine includes a built-in hard drive. Do not subject the machine to shock or vibration. In particular, never move the machine while the power is on.

- The machine should be installed near an accessible power outlet for easy connection.
- Connect the machine to a power outlet which is not used for other electric appliances. If a lighting fixture is connected to the same outlet, the light may flicker.

About consumables

⚠ WARNING

- ⊘ Do not throw a toner cartridge into a fire. Toner may fly and cause burns.
- ⊘ Store a toner cartridge out of the reach of children.

OPERATION MANUALS AND HOW TO USE THEM

Quick Start Guide (this document)

Features important safety notes, names of parts and components, information about the power-on procedure, operation overviews, information for people who manage the machine, and information about other aspects of this machine. Read this section before using the machine for the first time.

User's Manual (PC)

Can be downloaded from the machine to a computer and viewed. Refer to this document to learn more about printer mode and settings mode, and to learn about the details of each type of mode.

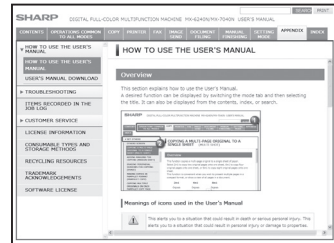

Administrator Machine Adjustment Guide

Explains fine adjustment of the machine, such as adjustment of the colour and fusing unit current, and adjustment of peripheral devices. Refer to this guide when you need to configure detailed machine settings.

User's Manual

Detailed explanations of the functions that can be used on the machine can be found in the "User's Manual".

The User's Manual can be downloaded from the machine to a computer, and viewed with a Web browser.

To download the User's Manual, see "DOWNLOADING MANUAL" on page 6.

To view the explanation of a function, click the appropriate tab and then click the function in the menu that appears at left.

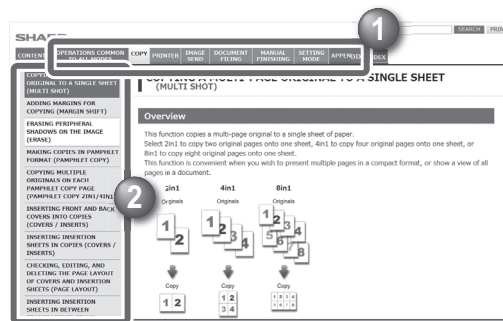

1 Click the tab of the desired mode.

2 Click the item that you want to view in the menu at left.

Software Setup Guide (CD-PDF)

Explains how to install the various drivers needed when using this machine as a printer, or network scanner. Refer to this document when using this machine from a computer. The Software Setup Guide can be found on the "Software CD-ROM".

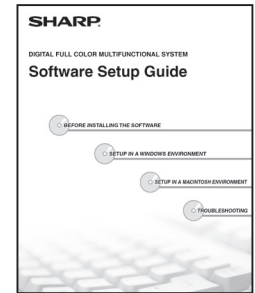

Operation Guide (Built-in)

Can be viewed by touching the operation guide icon on the machine's touch panel. When you are using this machine, use this document to see an overview of a particular mode or when you are having trouble operating the machine.



Hints

You can also search for a function in the Table of Contents or Index, or using the search function. This is convenient when you know what you want to do, but do not know where to look for it.

- OPERATIONS COMMON TO ALL MODES
- COPY
- PRINTER
- IMAGE SEND
- DOCUMENT FILING
- MANUAL FINISHING
- SETTING MODE
- APPENDIX

DOWNLOADING MANUAL

You can download the [User's Manual] or the [Administrator Machine Adjustment Guide] by following the procedures below while the machine is connected to the network. The User's Manual in HTML format provides detailed information that is necessary to use the machine, and explains what to do if you encounter a problem. Read and understand the User's Manual before using the machine.

For the procedures for using the User's Manual, refer to "HOW TO USE THE USER'S MANUAL" in the User's Manual.

The Administrator Machine Adjustment Guide explains fine adjustment of the machine, such as adjustment of the colour and fusing unit current, and adjustment of peripheral devices. Refer to this guide when you need to configure detailed machine settings.

Checking the machine's IP address

1 Press the [Home Screen] key.

The Home Screen appears.

2 Tap the [Settings] key.

The Settings Mode screen appears.

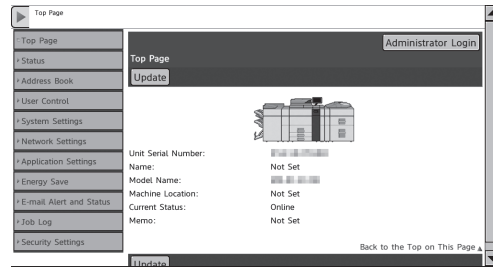

3 Confirm the machine's IP address

- (1) Tap the [System Settings] key in the left menu.
- (2) Tap the [List Print: (User)] key in the left menu.
- (3) Tap the [Print] key in the [All Custom Setting List].

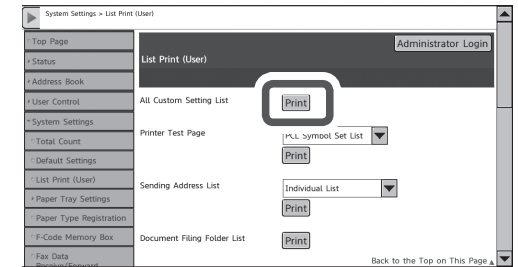

Downloading the User's Manual and the Administrator Machine Adjustment Guide

1 Insert the machine's IP address into the address bar of your web browser to access the machine.

http://machine's IP address/

User verification may be required depending on the machine's settings.

Please check with the machine's administrator to obtain the account information necessary for verification.

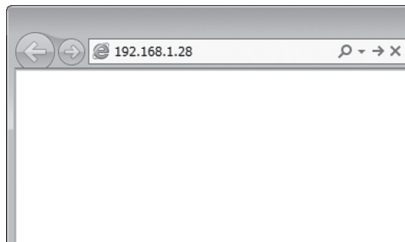

2 Download the [User's Manual] or the [Administrator Machine Adjustment Guide]

Click [Operation Manual Download] on the displayed page. Next, select the desired language from the "Language to download" list, and select [User's Manual] or [Administrator Machine Adjustment Guide] and then click the [Download] button.

3 Expand the downloaded "User's Manual".

When the User's Manual is selected:

When expansion is finished, the [User's Manual] folder is created. When the Administrator Machine Adjustment Guide is selected:

Go to step 5.

4 View the downloaded [manual].

When you view the User's Manual, open the [User's Manual] folder and double-click "index.htm".



When you view the Administrator Machine Adjustment Guide, double-click the downloaded PDF files.

Using the Operation Guide

The Operation Guide explains basic procedures for operating the machine.
This section explains how to check the procedure for loading paper in the Operation Guide.

- 1 Tap the [Operation Guide] key in the home screen.
The Operation Guide appears.

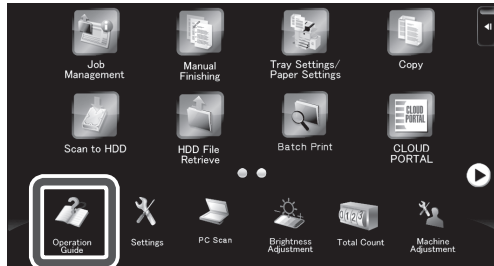

- 2 Tap [OPERATIONS COMMON TO ALL MODES].
The table of contents of OPERATIONS COMMON TO ALL MODES appears.

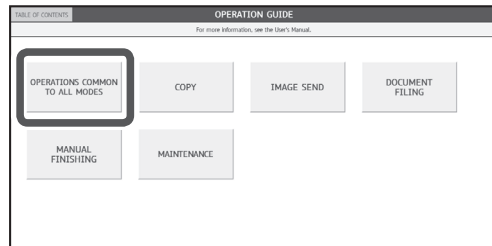

- 3 Tap [LOADING PAPER] in the left menu.
The table of contents of LOADING PAPER appears.

- 4 Tap the desired tray.
The explanation for loading paper in the tray you tapped appears.

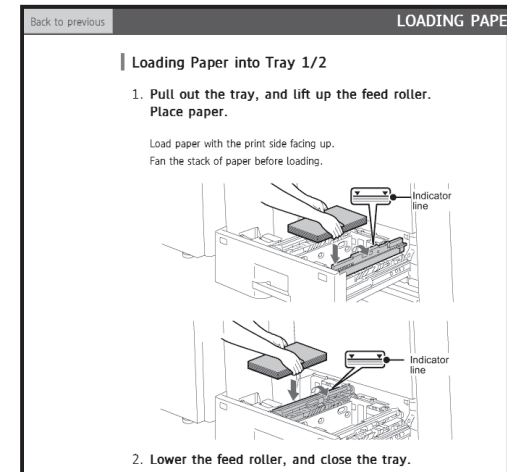

For detailed explanations and information not contained in the Operation Guide, refer to the User's Guide and Administrator Machine Adjustment Guide.

Settings Mode

"Settings Mode" can be used to manage functions that make it easier to use the machine, including specifying default settings for each function, configuring network connection settings, and viewing operation logs.

Settings Mode can also be used from a Web browser on a computer connected to the same network as the machine.

Paper properties, which allow fine adjustment of the machine to match the quality of the paper, can also be set in "Paper Tray Settings" in the system settings of Settings Mode.

To view the items that can be set in Settings Mode and the current settings of the items, you can print lists of the machine settings and the Web settings by selecting "Administrator Settings List" or "Web Settings List" in "List Print (Administrator)" in the system settings (administrator) of Settings Mode.

The procedure for printing an Administrator Settings List or the Web Settings List is explained below.

1 Tap the [Settings] key in the home screen.



Settings Mode appears.

2 Tap [System Settings] in the left menu.

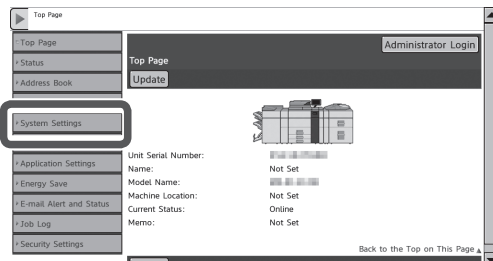

3 Tap [List Print (Administrator)] in the left menu.

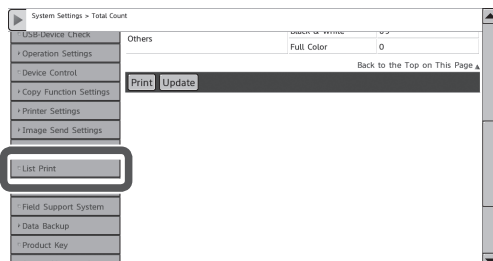

4 Enter the password in the administrator login screen.

To log in as an administrator, consult the administrator of the machine. After login is completed, the List Print (Administrator) screen appears.

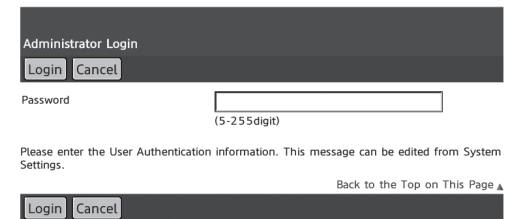

5 Tap [Print] in Administrator Settings List or Web Settings List.

In Administrator Settings List, you can print a list of the setting items and settings of each function (copy, scan, etc.) from the pull-down menu. To print a list of all setting items and settings, select [All Administrator Settings List].

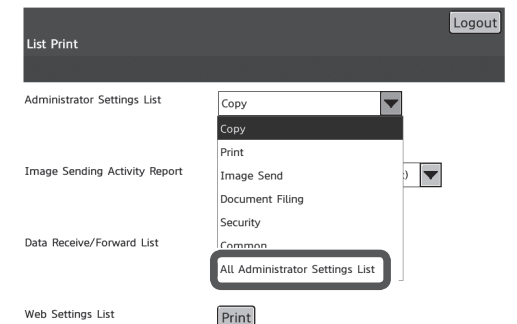

In Web Settings List, you can print a list of all setting items and settings in the Web menu.

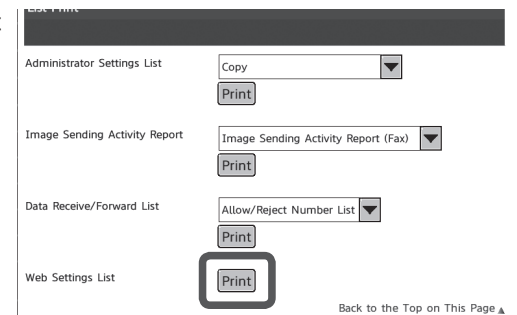

PART NAMES

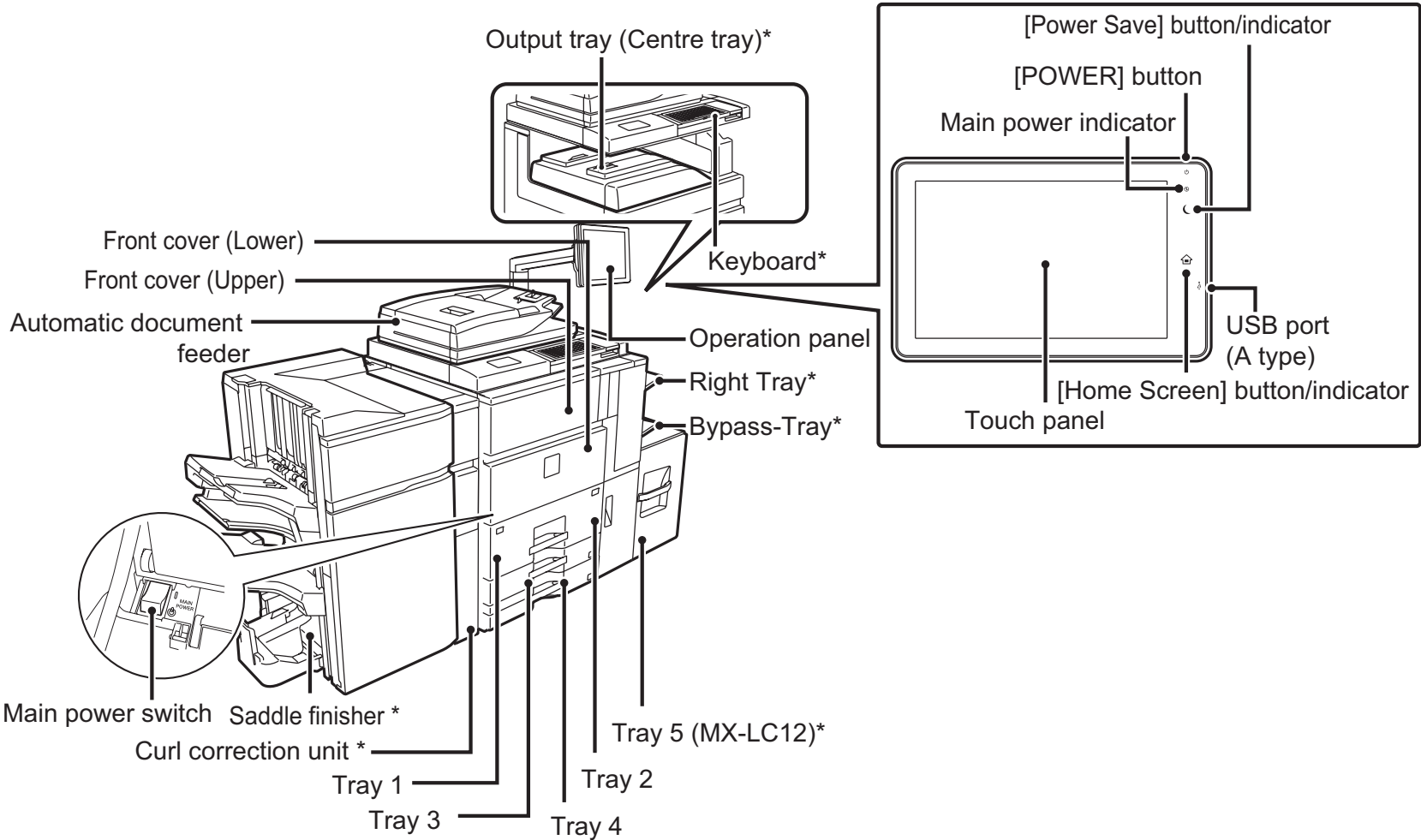

TURNING THE POWER ON AND OFF

This machine has a main power switch, found at the bottom left after the front cover is opened, and a power button (⏻), located on the operation panel.

Turning on the power

- Switch the main power switch to the “I” position.
- After the main power indicator lights in green, press the power button (⏻).

Turning off the power

- (1) Press the power button (⏻) to turn off the power.
- (2) Switch the main power switch to the “O” position.

Restarting the machine

In order for some settings to take effect, the machine must be restarted. If a message in the touch panel prompts you to restart the machine, press the power button (⏻) to turn off the power and then press the key again to turn the power back on.

CAUTION

- When turning off the power, make sure that the indicators on the operation panel turn off as well.
- If the machine suddenly turns off, such as in the event of a power failure, turn the machine on again, and then turn off the machine following the correct procedure for turning off the machine.
Switching off the main power switch or removing the power cord from the outlet while any of the indicators are lit or blinking may damage the hard drive and cause data to be lost.
- Switch off both the power button (⏻) and the main power switch and unplug the power cord if you suspect a machine failure, if there is a bad thunderstorm nearby, or when you are moving the machine.

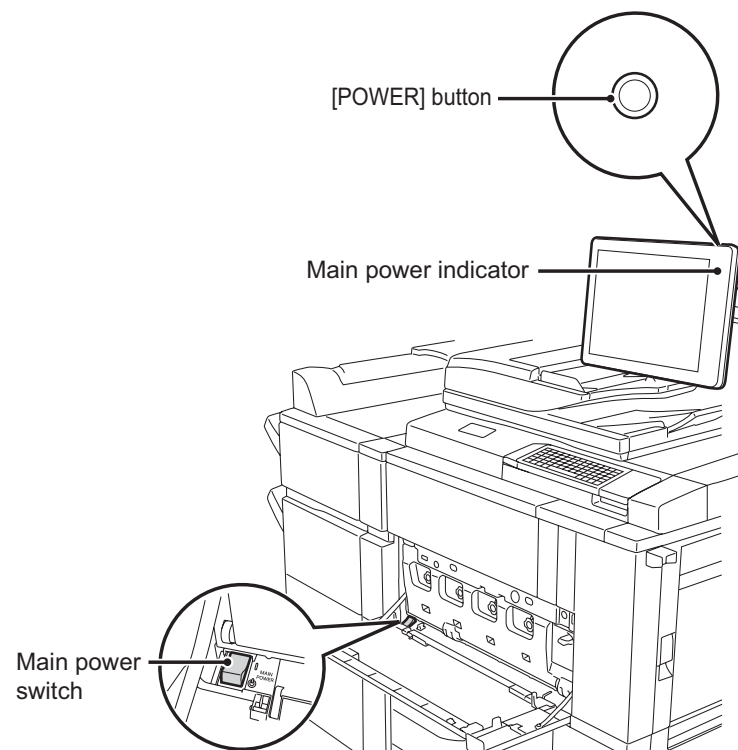

-  In some states of the machine, pressing the power button (⏻) to restart will not make the settings take effect. In this case, use the main power switch to switch the power off and then on.

HOME SCREEN

This screen appears first. When you touch an icon, the corresponding screen appears.

Pressing the [Home Screen] button on the operation panel also displays this screen.

* The screen may differ from the actual one depending on the model or customization.

HDD File Retrieve

The scanned original is saved on the hard disk drive of the machine or an external memory device.

This icon can also be tapped to edit or operate the stored data.

Job Management

Tap this icon to check the status of the job currently being executed.

Scrolling area

Up to 12 icons are displayed.

Icons that are not displayed can be displayed by scrolling horizontally.

Fixed area

Up to 10 icons are always displayed.

Operation Guide

See this document if you are experiencing problems while operating the machine.

Settings

In setting mode, various settings can be configured to suit the aims and needs of your application.

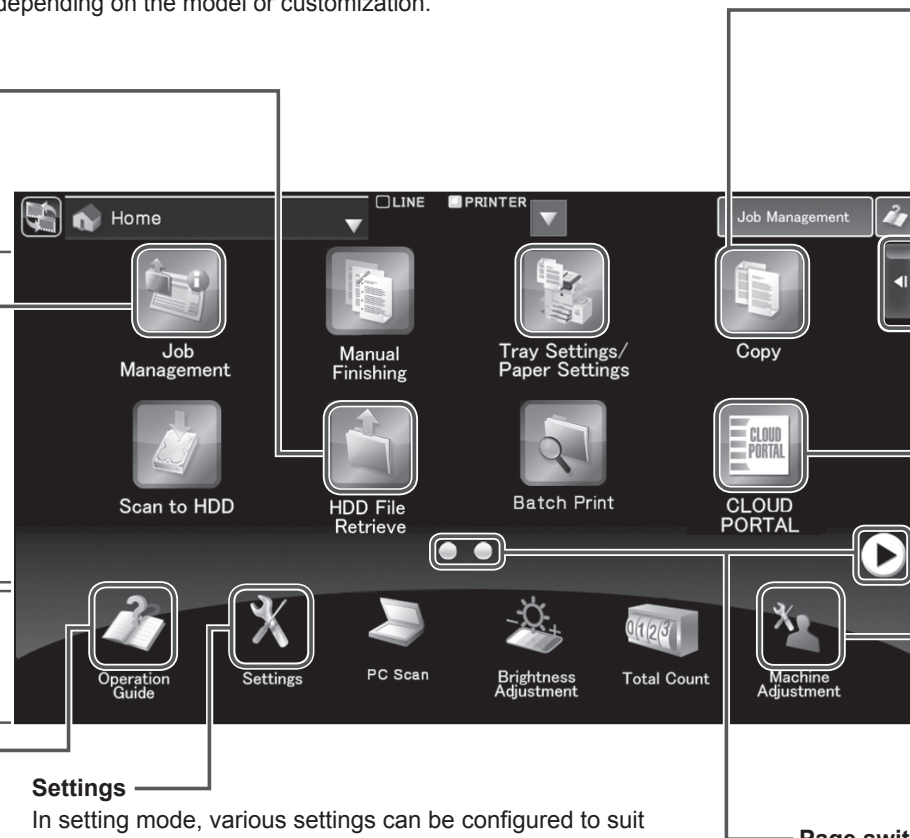

Copy

The scanned original is printed.

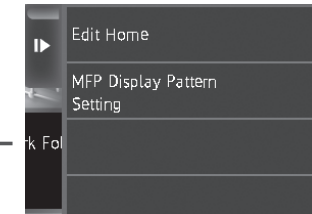

Action panel

Tap an item to edit Home Screen or other operation.

CLOUD PORTAL

When the machine is connected to the Internet, the "CLOUD PORTAL" icon can be tapped to access a site for login to CLOUD PORTAL.

The CLOUD PORTAL site lets you use Cloud services provided by SHARP.

In some countries and regions, the contents of the Home screen are different and CLOUD PORTAL cannot be accessed.

Machine Adjustment









The procedures for fine adjustment of the machine, such as adjustment of the color and fusing unit current, and adjustment of peripheral devices, are explained below. For advanced settings, refer to the Administrator Machine Adjustment Guide.

Page switch keys

Use these keys to view a hidden page in the scrolling area.

Operating the touch panel

In addition to the conventional "single tap" operation, you can also operate the touch panel using presses, flicks, and slides.

Tap 	Touch and then quickly release the finger. Used to select keys, tabs, checkboxes, etc.	Double tap 	Touch the screen twice. Use this operation to enlarge or reduce the image in the preview.	Drag 	Drag (slide the finger in the desired direction) to rotate or delete original pages displayed as a preview.	Pinch 	Touch the screen with two fingers and move them toward each other. This is used to reduce the browser and preview display.
Press 	Touch a key and keep the finger on the key for a short time.	Flick 	Flick (quickly swipe with the finger) to scroll the preview image.	Slide 	Slide the finger on the scroll bar to move up or down through a long list.	Spread 	Touch the screen with two fingers and move them away from each other. This is used to enlarge the browser and preview display.

MAINTENANCE

Replacing a toner cartridge

When toner runs low, the colour and the message “Prepare a new toner cartridge.” appears. Prepare a new toner cartridge for the indicated colour. When toner runs out, the colour and the message “Replace the toner cartridge.” appears. Replace the toner cartridge for the indicated colour.

Example: Replacing the yellow toner cartridge

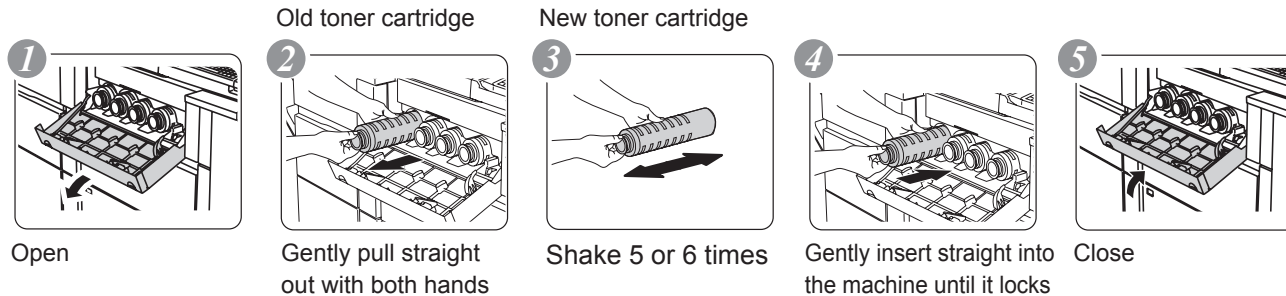

Caution

- Do not throw toner cartridges into a fire. Toner may fly and cause burns.
- Store toner cartridges out of the reach of small children.
- Always store toner cartridges on their sides. If toner cartridges are stored on end, the toner may harden and become unusable.
- Please use SHARP-recommended toner cartridges. If toner cartridges other than SHARP-recommended toner cartridges are used, the machine may not attain full quality and performance and there is a risk of damage to the machine.



- Do not dispose of used toner cartridges. Place them in a plastic bag and keep them. The technician will collect the used toner cartridges when performing maintenance.
- To view the approximate amount of toner remaining, continually touch the [Home Screen] key during printing or when the machine is idle. The percentage of toner remaining will appear in the display while the key is touched.
- When the percentage falls to “25-0%”, obtain a new toner cartridge and keep it ready for replacement.
- Depending on your conditions of use, the colour may become faint or the image blurred.

Removing misfeeds

When a paper misfeed occurs, the message “A misfeed has occurred.” will appear in the touch panel and printing and scanning will stop.

In this event, touch the [Check how to remove misfeeds] key in the touch panel.

When the key is touched, instructions for removing the misfeed will appear. Follow the instructions. When the misfeed is cleared, the message will automatically clear.

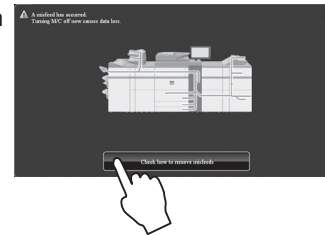

Caution

- The fusing unit and the output unit are hot.
- Take care not to touch the fusing unit when removing a misfeed.
- There is a risk of burning.

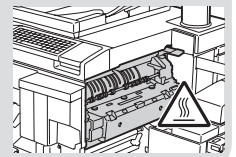

Replacing the waste toner box

When waste toner box becomes full, the message “Please replace the waste toner box.” will appear in the touch panel and printing and scanning will stop.

In this event, touch the [Information] key in the touch panel.

When the key is touched, instructions for replacing the waste toner box will appear. Follow the instructions.

When the waste toner box is replaced, the message will automatically clear.



Caution

- Do not throw the waste toner box into a fire. Toner may splatter and cause burns.
- Store the waste toner box out of the reach of small children.
- Keep the removed waste toner box in a plastic bag (do not discard them). Your service technician will collect the removed waste toner box.

PRINTER

Basic printing

■ In a Windows environment

This section explains how to print a document from "WordPad", which is a standard accessory application in Windows.

1 Select [Print] from the [File] menu

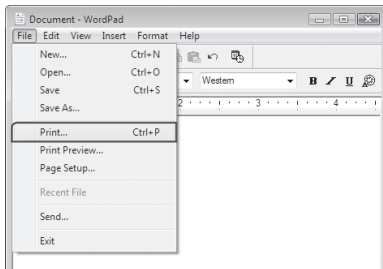

2 Select the printer driver for the machine and click the [Preferences] button

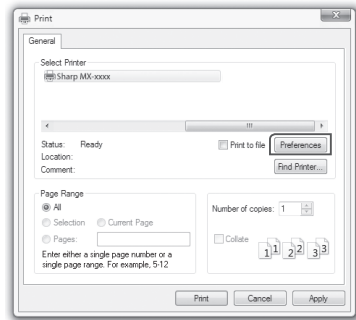

3 Click the [Paper] tab and select the paper size

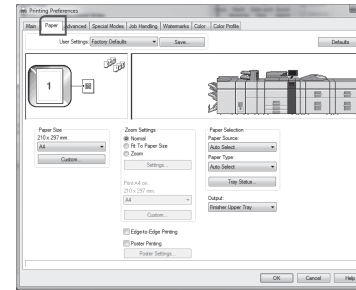

4 Click the [OK] button to start printing

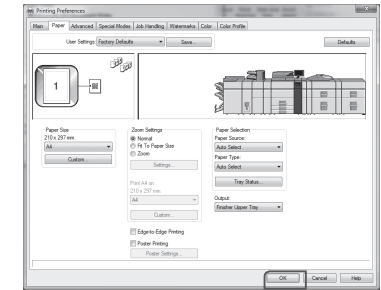

* Make sure the paper size is the same as the paper size set in the application.

■ For Mac OS X environments

The following example explains how to print a document from the standard accessory application "TextEdit" in Mac OS X.

1 Select [Page Setup] from the [File] menu and select the printer

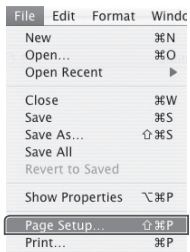

2 Configure paper and click the [OK] button

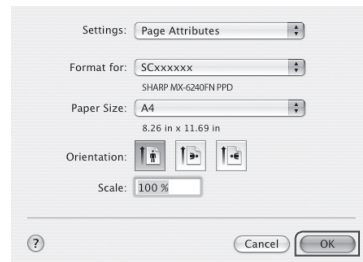

3 Select [Print] from the [File] menu. Make sure that the correct printer is selected.

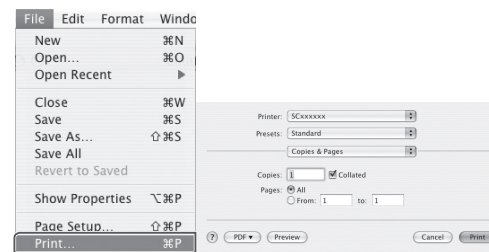

4 Print settings

5 Click the [Print] button to start printing

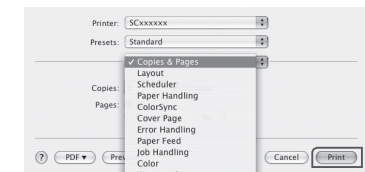

- Different types of paper sheets can be inserted for covers, etc.
- For Windows environments, different paper can be inserted into the specified page, or the paper can be inserted as inserts.

COPY

Basic operations

1 Place the original

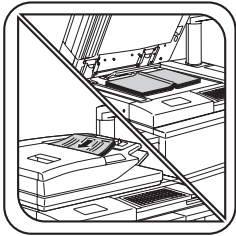

2 Copy settings

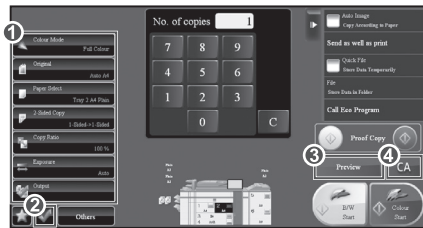

3 Preview



4 Specify the number of copies

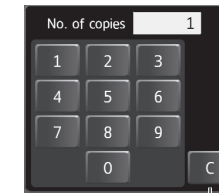

Corrects the number of copies

5 Start (Black & white, or colour)

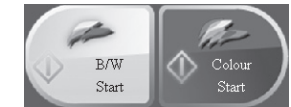

- 1 Copy settings
- 2 Displays the [Function Review] dialog
- 3 Scans the original and displays it in the preview area (if preview is required)
- 4 Cancels all settings

Copy settings

Colour Mode Full Colour

Colour mode

Auto	Automatically identifies colour or black & white to copy
Full Colour	Copies in full colour
B/W	Copies in black & white
2 Colour	Copies in 2 colours
Single Colour	Copies in a single colour

2-Sided Copy 1-Sided->1-Sided

2-sided copy

1-Sided->1-Sided	1-sided copy
1-Sided->2-Sided	Outputs two 1-Side original sheets to one 2-Side sheet
2-Sided->2-Sided	Outputs one 2-Side original sheet to one 2-Side sheet
2-Sided->1-Sided	Outputs one 2-Side original sheet to two 1-Side sheets

Output

Output

Middle tray	Outputs to the middle tray of the machine
Offset Tray	Outputs to the offset tray of the finisher
Sort	Outputs by sorting on a set basis
Group	Outputs by sorting on a page basis
Right Tray	Outputs to the output tray on the right of the machine

Copy Ratio 100 %

Copy Ratio

Zoom	Displays the basic ratio menu.																								
XY Zoom	Displays the XY Zoom ratio menu.																								
Auto Image	Automatically sets the ratio based on the original settings and paper settings.																								
<table border="1" style="font-size: small;"> <tr> <td>B4->B5</td><td>70%</td><td>115%</td><td>B5->A4</td></tr> <tr> <td>A3->A4</td><td></td><td></td><td>B4->A3</td></tr> <tr> <td>B5->A5</td><td>81%</td><td>122%</td><td>A5->B5</td></tr> <tr> <td>B4->A4</td><td></td><td></td><td>A4->B4</td></tr> <tr> <td>A4->B5</td><td>86%</td><td>141%</td><td>B5->B4</td></tr> <tr> <td>A3->B4</td><td></td><td></td><td>A4->A3</td></tr> </table>	B4->B5	70%	115%	B5->A4	A3->A4			B4->A3	B5->A5	81%	122%	A5->B5	B4->A4			A4->B4	A4->B5	86%	141%	B5->B4	A3->B4			A4->A3	Sets the ratio based on the original settings and paper settings.
B4->B5	70%	115%	B5->A4																						
A3->A4			B4->A3																						
B5->A5	81%	122%	A5->B5																						
B4->A4			A4->B4																						
A4->B5	86%	141%	B5->B4																						
A3->B4			A4->A3																						
100 (25~200) %	Enlarges or reduces the image in increments of 1%																								
Other Ratio	Transits to the "Other Ratio" screen																								
by Paper	Transits to the "by Paper" screen																								
by Size	Transits to the "by Size" screen																								

* Please note that the Bypass-tray is standard feature in some countries and regions.

Exposure	
Auto	Selects automatically
Text	Best for text originals
Text/Printed Photo	Prioritizes the quality of text and printed photo images
Text/Photo	Best for text originals to which photos are pasted
Printed Photo	Prioritizes the quality of printed photo images
Photo	Best for photo originals
Map	Best for maps containing fine text
Light Original	Best for faint coloured originals such as those written using pencil
1 . . . 3 . . . 5	Tap a darker or lighter area to adjust shading
Copy of Copy	Select this option for copied or printed originals
Colour Tone Enhancement	Select this option to enhance the colour of a colour copy

Original																															
Auto	Selects automatically																														
Inch	Displays inch size list																														
AB	Displays AB size list																														
Direct Entry	Displays the direct entry screen																														
Custom Size	Displays the custom size list																														
<table border="1"> <thead> <tr> <th colspan="4">AB</th> <th colspan="2">Inch</th> </tr> </thead> <tbody> <tr> <td>A5</td> <td>A5R</td> <td>B5</td> <td>B5R</td> <td>5 1/2 x 8 1/2</td> <td>5 1/2 x 8 1/2 R</td> </tr> <tr> <td>A4</td> <td>A4R</td> <td>B4</td> <td>A3</td> <td>8 1/2 x 11</td> <td>8 1/2 x 11 R</td> </tr> <tr> <td colspan="2">216 x 340</td> <td colspan="2">216 x 343</td> <td>8 1/2 x 13</td> <td>8 1/2 x 14</td> </tr> <tr> <td colspan="4"></td> <td>11 x 17</td> <td>8 1/2 x 13 2/5</td> </tr> </tbody> </table>		AB				Inch		A5	A5R	B5	B5R	5 1/2 x 8 1/2	5 1/2 x 8 1/2 R	A4	A4R	B4	A3	8 1/2 x 11	8 1/2 x 11 R	216 x 340		216 x 343		8 1/2 x 13	8 1/2 x 14					11 x 17	8 1/2 x 13 2/5
AB				Inch																											
A5	A5R	B5	B5R	5 1/2 x 8 1/2	5 1/2 x 8 1/2 R																										
A4	A4R	B4	A3	8 1/2 x 11	8 1/2 x 11 R																										
216 x 340		216 x 343		8 1/2 x 13	8 1/2 x 14																										
				11 x 17	8 1/2 x 13 2/5																										

Others					
Multi Shot	Copying a multi-page original to a single sheet	Margin Shift	Adds margins	Erase	Specify the edge erase (centre erase) and erase width of the original for copies
Pamphlet Copy	Arranges a pamphlet format	Covers/Inserts	Inserts cover or insertion sheets	Transparency Inserts	Outputs transparency films in a way that they do not stick together
Blank Page Skip	Skipping blank pages in an original	Card Shot	Copies both sides of a card as a single page	Position Image	Specify the image print position
Tab Copy	Copies captions onto tab paper	Dual Page Copy	Copies each facing page	Book Copy	Copies a pamphlet
Book Divide	Splits a pamphlet original by page in a copy	Stamp	Prints dates, the number of pages, and stamps	Custom Image	Adds a registered image to an original
Hidden Pattern Print	Padding unauthorised copy deterrent data	Repeat Layout	Repeats the same image on one sheet in a copy	Multi-Page Enlargement	Making a poster-sized copy
Mirror Image	Inverts the original into a mirror image	Full Bleed Copy	Copies originals with no edge cut-off	Centring	Copying in the centre of the paper
B/W Reverse	Reverses white and black	Job Build	Copies many originals at once	Tandem Copy	Using two machines to copy in parallel
Original Count	Check the number of scanned original sheets	Mixed Size Original	Copies originals of different sizes together	Slow Scan Mode	This mode switches document feeder controls for originals with thin paper thickness
Sharpness	Adjust the sharpness of an image	Scan Resolution	Specify the resolution of the original	RGB Adjust	Adjusting red/green/blue in copies
Suppress Background	Suppresses light background area in copies	Color Balance	Adjust the colour of a copy image	Brightness	Adjust the brightness of a colour copy image
Intensity	Adjust the intensity (saturation) of a colour copy image	File	Uses document filing	Quick File	Temporarily saves the scanned data on the hard disk drive of the machine
Preview Edit	Displays a preview image after selection				

SCAN

Basic Operations (Scan to E-mail)

1 Place the original

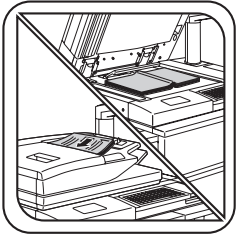

2 Scan settings

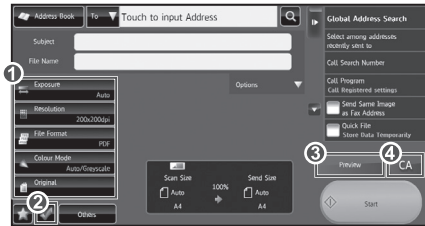

3 Preview

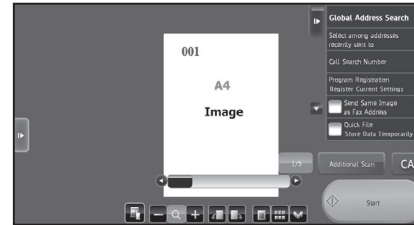

4 Specify the destination



5 Start



- 1 Scan settings
- 2 Displays the [Function Review] dialog
- 3 Scans the original and displays it in the preview area (if preview is required)
- 4 Cancels all settings

Scan settings

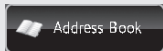

Address Book

Tap this to display the address book screen to select a destination.



Tap this to switch between To and Cc.



Searches a destination

File Name

File Name

Select a file name or enter it directly.

Subject

Subject

Select a subject or enter it directly.

Touch to input Address

Touch to input Address

Enter an address directory.

Resolution 200x200dpi

Resolution

100x100dpi

300x300dpi

100 x 100 dpi

150 x 150 dpi

200 x 200 dpi

300 x 300 dpi

400 x 400 dpi

600 x 600 dpi

150x150dpi

400x400dpi

200x200dpi

600x600dpi

Exposure Auto

Exposure

Auto

Selects automatically



Touch a darker or lighter area to adjust shading

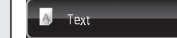

Best for text originals



Prioritizes the quality of text and printed photo images



Best for text originals to which photos are pasted



Prioritizes the quality of photo images



Best for photo originals



Best for maps containing fine text

File Format

This function sets the file format and compression mode (ratio) of send data.

File format		Compression mode		Number of pages setting		
Colour/Greyscale		B/W	Colour/Greyscale	B/W	Colour/Greyscale/Black & white	
<p>TIFF</p> <p>XPS</p> <p>JPEG</p> <p>PDF</p> <p>PDF/A</p>	Transmittable formats: TIFF, XPS, JPEG, PDF, PDF/A	Transmittable formats: TIFF, XPS, PDF, PDF/A	Low Middle High Bk Letter Emphasis None MH (G3) MMR (G4)	Compressible modes: Low, Medium, High, Bk Letter Emphasis <input type="checkbox"/> Compact Sends data by reducing its size <input type="checkbox"/> U-Fine Sends data by reducing its size but without reducing the image quality	Compressible modes: None, MH (G3), MMR (G4)	<input type="checkbox"/> Specified Pages per File Specify the number of pages per file <input type="text" value="1"/> (1 ~ 99) Page Displays the number of pages per file <input type="button" value="-"/> <input type="button" value="+"/> Increases or decreases the number of pages per file
	<input type="checkbox"/> Ency. Creates an encrypted PDF file	<input type="checkbox"/> Ency. Creates an encrypted PDF file				

Others

Job Build	Tap this to switch the job build mode on or off. Setting it to On scans a large number of originals in segments.	Slow Scan Mode	Scans a thin original	Mixed Size Original	Scans originals of different sizes together
Original Count	Tap this to switch the original count setting on or off. Setting it to On checks the scanned number of original sheets.	Erase	Specify the edge erase (centre erase) and erase width of the original to be sent	Dust Page Scan	Scans an original as two separate pages
Book Divide	Sends a pamphlet original by splitting it by page	Card Shot	Sends both sides of a card as a single page	Timer	Automatically performs transmission at the specified time
Verif. Stamp	Stamps scanned originals	Suppress Background	Scans originals by suppressing light background area	Blank Page Skip	Erases blank pages mixed in an original after scanning
Drop Out Colour	Removes chromatic colours from the scanned original before transmission	Sharpness	Adjust the sharpness of an image to produce a sharper or softer image.	Contrast	Adding contrast to the scanned original before transmission.
File	Saves the send data on the hard disk drive of the machine.	Quick File	Temporarily saves the send data on the hard disk drive of the machine		

DOCUMENT FILING

This function saves the original scanned on the machine, or print data from a PC on the hard disk drive of the machine or on an external memory device. The saved data can be printed or sent. Editing of the stored files, for example combining, is also possible.

Basic operations

1 HOME SCREEN

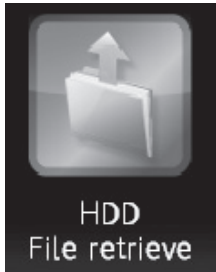

2 Select the folder



3 Place the original

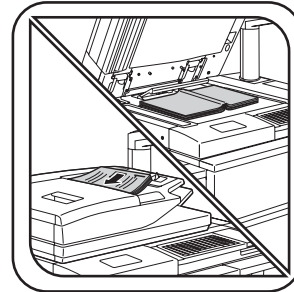

4 Start

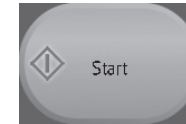

Folder select screen

Main Folder

Use this to save the original you wish to share among users.

Custom Folder

The folder for the registered user.

HDD Status

The usage of the machine's hard disk drive is displayed in graphical format, separately for Main Folder, Custom Folder, and Quick File Folder.

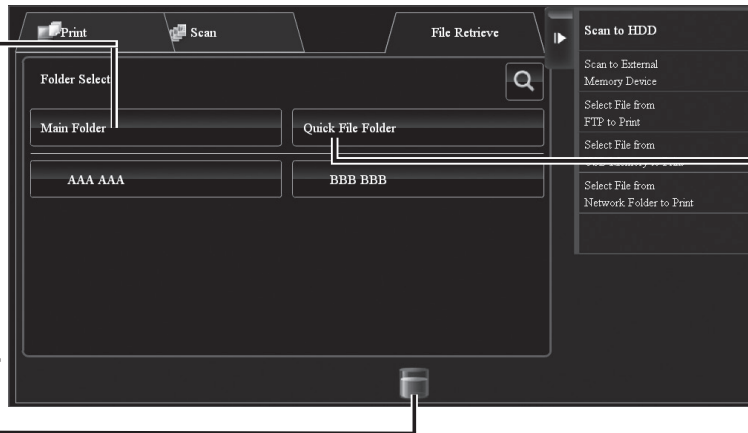

Quick File Folder

Saves files temporarily.



- Files stored using [Quick File] are provided with the "Sharing" property that can be accessed by any person for output and sending. Therefore, do not store sensitive documents or documents that you do not want to be used by others using the [Quick File] function.

File list view

You can select the method to display files. List view or thumbnails view can be selected.

■ Viewing by folder



■ Viewing by job



File thumbnails view



Job settings menu

Select a file you wish to retrieve, then select a desired operation. The following operations are displayed on the action panel. The [Print Now] operation is not displayed on the action panel but displayed as a button in the trigger area.

Change Settings to Print	Prints a file from the reprint screen This item changes to [Print] when multiple files are selected.	<input type="checkbox"/> Print and Delete the Data	Select this item if you wish to delete data after printing.
Move	Moves a file You can also edit the file name using this option.	<input type="checkbox"/> Print B/W	Select this item if you wish to print all in black & white This item is not displayed when multiple files are selected.
Combine File	Merges the selected two files into a single file This item is not displayed when only one file or three or more files are selected.		Prints the selected file immediately
Check Image	Check the content of the original file by image This item is not displayed when multiple files are selected.	<input type="checkbox"/> Delete	Deletes data
See Detail Information	Views property change and file detail information This item is not displayed when multiple files are selected.		

COPY OUTPUT

Configure the output settings for copies using Sort, Group, Offset, Staple, Punch, or Fold.

Basic operations

1 Select [Output]

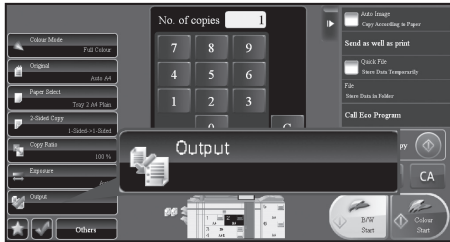

2 Copy output settings

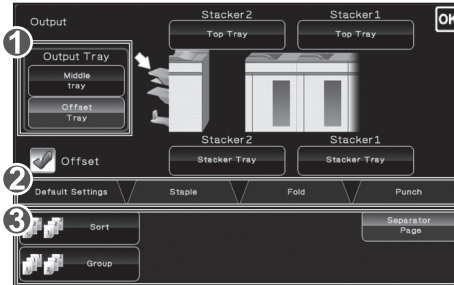

- 1 Specify the output tray
- 2 Select the output and paper output type
- 3 Specify the details of output mode

3 Check the preview image

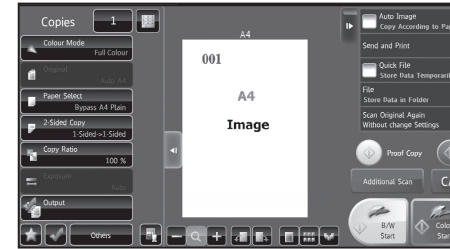

4 Start (Black & white, or colour)



Output tray settings

Output tray settings

Specify the destination to output copies.
The output tray currently selected is indicated by an arrow.

(When a finisher (100-sheet stapling) or saddle finisher (100-sheet stapling) is installed)
The [Middle Tray] key can be selected.



Outputs to the offset tray

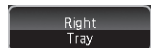

Outputs to the right tray
If the offset, staple sort, saddle stitch, fold, or punch function is specified, the right tray is not available.

Sort/Group function

This function sets the sorting method when copying a scanned original.



Sorts the scanned original on a set basis, and outputs them



Groups the scanned original on a page basis, and outputs them.

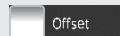

Offset

Offset function

(When a finisher or saddle finisher is installed)

Select this function when you wish to output copies while shifting them set by set.
Selecting the staple function clears the Offset checkmark automatically.

Sort staple

(When a finisher or saddle finisher is installed)

This function staples the output copies and deliver them to the tray.



1 staple in back



1 staple in front



2 Staples

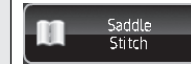

Copies can be folded at the centre, stapled, and output.
This function is only available when a saddle finisher is installed.

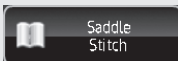

Saddle Stitch

(When a saddle finisher is installed)

Copies can be folded at the centre, stapled, and output.

(When a trimming module is installed on the saddle finisher)

For saddle folding, it trims a side drop, offering a good-looking output image.

	Releases saddle stitch
	This selects left binding
	This selects right binding

	Scanning 2-Sided originals
	Tap this to switch the cover setting Off or On, or to configure the paper tray settings.
	Scans 1-Sided originals

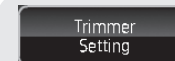

Trimmer Setting

(When a trimming module is installed on the saddle finisher)
Enabling "Saddle Stitch" allows you to configure the trimmer settings.

	Turns off the trimmer setting
	Turns on the trimmer setting
	Specify the trimming width within the range of 2.0 to 20.0 mm

Folding function

(When a saddle finisher or folding unit is installed)

Copies can be folded and output.

	Selects saddle fold
	Selects Z-fold
	Selects C-fold
	Selects accordion fold
	Selects double fold
	Selects half fold

Detail setting screen for each folding type

	Folds paper so that the print side faces downward during output		Select the size of paper to be folded with Z-fold (One of either A3, B4, A4R, 11" x 17", 8-1/2" x 14" and 8-1/2" x 11"R can be selected)
	Folds paper so that the print side faces upward during output		
	Select this option to fold multiple sheets together		Folds paper for left binding during output
	Displays a folding image		Folds paper for right binding during output

Punch function

(When a punch module is installed)

This function punches copies and outputs them. It is available for paper sizes B5R to A3.

	Punches holes during output

MANUAL FINISHING

This function allows you to set for finish on copied or printed pages.

You can select the manual finishing mode if the inserter is installed.

When the finisher (100-sheet stapling), saddle finisher (100-sheet stapling), punch module, or folding unit is installed, finishing operations, such as stapling, punching or folding, can be performed.

Basic operations

1 Place the original

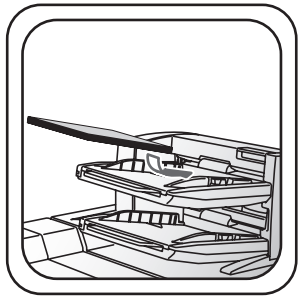

2 Switch to the manual finishing mode

- Changing modes from the Home Screen



3 Finishing method settings

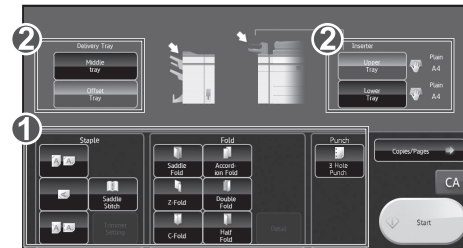

4 Start

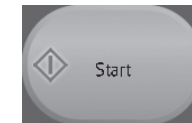

- 1 Select the appropriate finishing method
- 2 Change the paper tray or output tray as required

Adjust the inserter tray guide to the paper size, and load paper.
(Special media such as transparency film and tab paper cannot be used.)

Paper Loading and Output Settings



Checking and changing the output tray

You can check the type and size of paper loaded. As needed, the paper type and size can be specified for each of the upper and lower trays.
If you wish to change the paper sizes or types, select [System Settings] > [Paper Tray Settings] > [Inserter].



Check the paper type and size

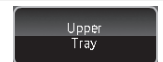

Selects the upper tray as paper tray

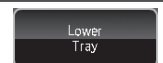

Selects the lower tray as paper tray

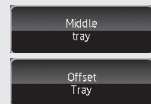

Checking and changing the output tray

The output tray is automatically selected based on the output function you set. If Z-Fold, Half Fold, or Punch is selected, however, you can select the middle or offset tray for the output tray.
If you have changed the output tray, the output function may be deselected depending on the original output settings.

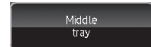

Selects the middle tray as the output tray

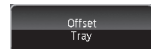

Selects the offset tray as the output tray



Orientation of placed original

For stapling or punching on the desired position, place the paper as shown in the following:

- For staple function, place the paper face up and align text with the direction of the touch panel display. (For the saddle stitch function, place the paper so that middle surface faces up.)
- When using punch or folding function, place the paper face up, and align text horizontally and upward with the scan (right) direction.

Staple

(When a finisher installed)

This function staples the loaded paper sheets into a sheaf.



1 staple in back



1 staple in front



2 Staples

Saddle Stitch

(When a saddle finisher (100-sheet stapling) is installed)

This function staples each set of copies at two positions in the centre of paper, folds them in half, and outputs them.

(When a trimming module is installed on the saddle finisher)

For saddle stitch, it trims a side drop, offering a good-looking output image.

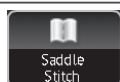

Staples each set of copies at two positions in the centre of paper, and folds them in half during output

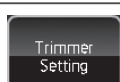

Trims a side drop for saddle folding during output
Specify the trimming width within the range of 2.0 to 20.0 mm

Folding function

(When a folding unit is installed)

This function folds paper in Z-fold, C-fold, or other types of shapes.

(When a saddle finisher (100-sheet stapling) is installed)

Paper can be folded in a saddle fold.

* The paper sizes that can be selected vary depending on the type of paper fold.

* Special media such as transparency film and tab paper cannot be used.

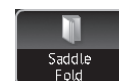

Allowable paper sizes:
A3W, A3, B4, A4R, SRA3, 12"x18", 11"x17",
8-1/2"x14", 8-1/2"x11"R, 8K
The fold settings can be configured in [Detail].

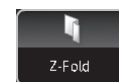

Allowable paper sizes:
A3, B4, A4R, 11" x 17", 8-1/2"x14", 8-1/2"x11"R
This can be used with staple or punch function only when the A3, B4 or 11"x17" paper is used.



Allowable paper sizes:
A4R, 8-1/2"x11"R



Allowable paper sizes:
A4R, 8-1/2"x11"R

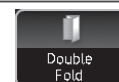

Allowable paper sizes:
A4R, 8-1/2"x11"R

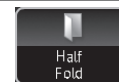

Allowable paper sizes:
A4R, 8-1/2"x11"R

Setting the number of copies (number of pages)

Copies/Pages

This function loads previously sorted sheets and outputs multiple sets at once.

Number of copies setting

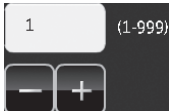

Enter the number of output copies (from 1 to 999)

Number of pages setting



Select this to set all pages as one set
* If this setting is enabled, set the [Number of Copies] to "1".



Select this to specify the number of page for each set

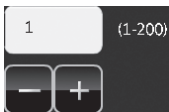

Enter a numeric value when [Manual] is selected.
(from 1 to 200 pages)

Checking and changing the output tray

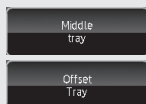

The output tray is automatically selected based on the output function you set. If Z-Fold, Half Fold, or Punch is selected, however, you can select the middle or offset tray for the output tray. If you have changed the output tray, the output function may be deselected depending on the original output settings.

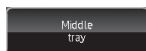

Selects the middle tray as the output tray

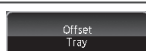

Selects the offset tray as the output tray

Punch function

(When a punch module is installed)

This function punches holes in paper. It is available for paper sizes B5R to A3.

You cannot use A3W (12" x 18") size paper, and special media such as transparency film and tab papers.

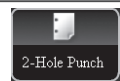

Punches holes during output
If the paper size used is A3, B4 or 11"x17", this function can be used with saddle stitch or folding function for Z-fold.

SPECIFICATIONS

Basic Specifications / Copier specifications

Name	MX-6500N/MX-7500N		
Type	Console		
Colour	Full colour		
Copier system	Laser electrostatic copier		
Scanning resolution	Scan (B/W): 600 × 400 dpi, 600 × 600 dpi Scan (full colour): 600 × 600 dpi Print: 600 × 600 dpi, 1200 × 1200 dpi equivalent to 9,600 dpi × 600 dpi		
Gradation	Scan: equivalent to 256 levels / Print: equivalent to 256 levels		
Original paper sizes	Max. A3 (11" × 17") for sheets and bound documents		
Copy sizes	<p>A3 wide (13" × 19", 12" × 18") to A5R, 5-1/2" × 8-1/2"R, Transparency film, Heavy paper, Envelopes</p> <p>Tray 1: A4, B5, 8-1/2" × 11"</p> <p>Tray 2: A4, 8-1/2" × 11"</p> <p>Tray 3: A3 wide (12" × 18"), A3, B4, A4, A4R, B5, B5R, 8K, 16K, 16KR, 11" × 17", 8-1/2" × 14", 8-1/2" × 13-1/2", 8-1/2" × 13-2/5", 8-1/2" × 13", 8-1/2" × 11", 8-1/2" × 11"R, 7-1/4 × 10-1/2"R, 9" × 12",</p> <p>Tray 4: A3 wide (12" × 18"), A3, B4, A4 wide, A4, A4R, B5, B5R, A5R, 11" × 17", 8-1/2" × 14", 8-1/2" × 13-1/2", 8-1/2" × 13-2/5", 8-1/2" × 13", 8-1/2" × 11", 8-1/2" × 11"R, 7-1/4 × 10-1/2"R, 5-1/2" × 8-1/2"R,</p> <p>Multi-bypass tray: A3 wide (13" × 19") to SRA3, SRA4, A5R, 8K, 16K, 16KR, 5-1/2" × 8-1/2"R, Transparency film, Heavy paper, Envelopes</p> <p>Lost margin (leading edge): 4 mm (11/64") ± 1 mm (± 3/64")</p> <p>Lost margin (trailing edge): 2 mm (6/64") - 5 mm (- 13/64")</p> <p>Leading edge / trailing edge: total 8 mm (21/64") or less</p> <p>Near edge / far edge: total 4 mm (11/64") ± 2 mm (± 6/64") or less</p> <p>Maximum print area: 319 mm × 480 mm</p> <p>Image quality assurance range: 303 mm</p>		
Warm-up time	90 seconds ● This may vary depending on the ambient conditions.		
First-copy time		MX-6500N	MX-7500N
	Full colour:	5.6 seconds	5.1 seconds
	B/W:	4.0 seconds	3.7 seconds
	● This may vary depending on the state of the machine.		
Continuous copying speeds* (when shifter is not in operation)		MX-6500N	MX-7500N
	A4, B5, 8-1/2" × 11":	65 copies/min.	75 copies/min.
	A4R, B5R, 8-1/2" × 11"R, 7-1/4" × 10-1/2"R:	42 copies/min.	47 copies/min.
	A5R, 5-1/2" × 8-1/2"R:	43 copies/min.	47 copies/min.
	B4, 8-1/2" × 14":	36 copies/min.	41 copies/min.
	A3, 11" × 17":	32 copies/min.	36 copies/min.
	* Continuous speed for same original source. Output may be temporarily interrupted to stabilize image quality.		

Copy ratios	Same size: 1:1 ± 0.5 % Enlarge: 115 %, 122 %, 141 %, 200 %, 400 % Reduce: 25 %, 50 %, 70 %, 81 %, 86 % Zoom range: 25 to 400 % (25 - 200 % using DSPF) in 1 % increments, total 376 increments. Can calculate zoom rate when mm is specified.
Useable paper	See "SIZE AND TYPES PAPER THAT CAN BE SET IN EACH TRAY" (page 32)
Paper feed / capacity	1,200 plus 800 plus 500 plus 500 sheets in 4 trays plus 100-sheet multi-bypass tray ● Using 80 g/m ² . (21 lbs) weight paper
Max. paper feed / max. capacity	1,200 plus 800 plus 500 plus 500 sheets in 4 trays plus 500-sheet multi-bypass tray plus 5,000 sheets in large capacity trays plus 5,000 sheets in large capacity trays (total 13,500 sheets) ● Using 80 g/m ² . (21 lbs) weight paper
Continuous copy	Max. 9,999 copies
Memory	Standard: 5 GB HDD: 1 TB SD card: 4GB ● 1 GB = One billion bytes when referring to hard drive capacity. Actual format capacity is less.
Ambient environment	Operating environment 10 °C (54 °F) to 35 °C (91 °F) (20 % to 85 % RH) (Humidity is 60% or below while the temperature is 35°C (91°F), and the temperature is 30°C (86°F) or below while the humidity is more than 85%.) 590 - 1,013 hpa Standard environment 20 °C (68 °F) to 25 °C (77 °F) (65 ± 5 % RH)
Required power supply	AC 220-240V, 8A + 8A, 60 Hz (2 × 220-240V power supplies) Power consumption Max. 1.92 kW + 1.92 kW
Dimensions	982 mm (W) × 768 mm (D) × 1,530 mm (H) (38-43/64" (W) × 30-1/4" (D) × 60-1/4" (H))
Weight	Approx. 229 kg (505 lbs.)
Overall dimensions	With multi-bypass tray extended 1,245 mm (W) × 768 mm (D) (49-1/32" (W) × 30-1/4" (D))

Automatic document feeder (Standard equipment)

Name	Duplex Single Pass Feeder (DSPF)	
Document feeder types	Duplex Single Pass Feeder (DSPF)	
Original paper sizes	A3 (11" × 17") to A5 (5-1/2" × 8-1/2")	
Original paper types	Paper weight	Thin paper 35 g/m ² (9 lbs. Bond) to 49 g/m ² (13 lbs. Bond)
		Plain paper 50 g/m ² (13 lbs. Bond) to 128 g/m ² (34 lbs. Bond)
	Two-sided	50 g/m ² (13 lbs. Bond) to 128 g/m ² (34 lbs. Bond)

Paper storage capacity	150 sheets (21 lbs. (80 g/m ²)) (or maximum stack height of 49/64" (19.5 mm))
Scan speed (copy)	B/W: 75 one-sided sheets/minute (A4 (8-1/2" × 11") horizontal) (600 × 400 dpi)
	Colour: 51 one-sided sheets/minute (A4 (8-1/2" × 11") horizontal) (600 × 600 dpi)

Large Capacity Trays

MX-LC13

Name	Large Capacity Trays
Paper sizes	See "SIZE AND TYPES PAPER THAT CAN BE SET IN EACH TRAY" (page 32)
Useable paper	See "SIZE AND TYPES PAPER THAT CAN BE SET IN EACH TRAY" (page 32)
Paper capacity	5,000 sheets (2,500 × 2)
Required power supply	AC 230V, 10 A
Dimensions	895 mm (W) × 763 mm (D) × 986 mm (H) (35-1/4" (W) × 30-1/32" (D) × 38-13/16" (H))
Weight	Approx. 131 kg (288 lbs.)

MX-MF11

Name	Multi Bypass Tray
Paper sizes	See "SIZE AND TYPES PAPER THAT CAN BE SET IN EACH TRAY" (page 32)
Useable paper	See "SIZE AND TYPES PAPER THAT CAN BE SET IN EACH TRAY" (page 32)
Paper capacity	500 sheets
Required power supply	Supplied from large capacity trays
Dimensions	When output paper tray is stored 705 mm (W) × 556 mm (D) × 203 mm (H) (27-3/4" (W) × 21-7/8" (D) × 8" (H))
	When output paper tray is extended 878 mm (W) × 556 mm (D) × 203 mm (H) (34-9/16" (W) × 21-7/8" (D) × 8" (H))
Weight	Approx. 18 kg (39 lbs.)

Large Capacity Tray

MX-LC12

Name	Large Capacity Tray
Paper sizes	See "SIZE AND TYPES PAPER THAT CAN BE SET IN EACH TRAY" (page 32)
Useable paper	See "SIZE AND TYPES PAPER THAT CAN BE SET IN EACH TRAY" (page 32)
Paper capacity	3,500 sheets
Dimensions	376 mm (W) × 576 mm (D) × 524 mm (H) (14-51/64" (W) × 22-43/64" (D) × 20-5/8" (H))
Weight	Approx. 28.5 kg (63 lbs.)

MX-LCX3 N

Name	Large Capacity Tray
Paper sizes	See "SIZE AND TYPES PAPER THAT CAN BE SET IN EACH TRAY" (page 32)
Useable paper	See "SIZE AND TYPES PAPER THAT CAN BE SET IN EACH TRAY" (page 32)
Paper capacity	3,000 sheets
Dimensions	670 mm (W) × 570 mm (D) × 525 mm (H) (26-3/8" (W) × 22-7/16" (D) × 20-43/64" (H))
Weight	Approx. 50 kg (110 lbs.)

Finisher

MX-FN21

Name	Finisher (100-sheet stapling)	
Paper sizes	Depends on feeder specifications	
Useable paper	55 to 300 g/m ² Index (16 lbs. Bond to 170 lbs.)	
No. of trays	3	
	Upper tray	
	Non-stapled	A3W (13" x 19", 12" x 18") / A3 (11" x 17") / B4 (8-1/2" x 14"), SRA3/ SRA4: 750 sheets A4 (8-1/2" x 11") / A4R, B5 (8-1/2" x 11"R) / B5R (7-1/4" x 10-1/2"R) / A5R (5-1/2" x 8-1/2"R): 1,500 sheets
	Staple function	A3 (11" x 17") / B4 (8-1/2" x 14"): 50 units or 750 sheets A4 (8-1/2" x 11") / A4R, B5 (8-1/2" x 11"R): 100 units or 1,500 sheets
	Centre tray	
	Non-stapled	A3W (13" x 19", 12" x 18") / A3 (11" x 17") / B4 (8-1/2" x 14"), SRA3 / SRA4: 125 sheets A4 (8-1/2" x 11") / A4R, B5 (8-1/2" x 11"R) / B5 (R7-1/4" x 10-1/2"R) / A5 (R5-1/2" x 8-1/2"R): 250 sheets
Tray capacity (21 lbs. (80 g/m ²))	Lower tray	
	Non-stapled	A3W (13" x 19", 12" x 18") / A3 (11" x 17") / B4 (8-1/2" x 14"), SRA3 / SRA4: 750 sheets A4 (8-1/2" x 11") / A4R, B5 (8-1/2" x 11"R) / B5R (7-1/4" x 10-1/2"R) / A5R (5-1/2" x 8-1/2"R): 1,500 sheets A4 / B5 / 8-1/2" x 11" Non offset: 2,500 sheets
	Staple function	A3 (11" x 17") / B4 (8-1/2" x 14"): 50 units or 750 sheets A4 (8-1/2" x 11") / A4R, B5 (8-1/2" x 11"R): 100 units or 1,500 sheets
	<ul style="list-style-type: none"> Offset output is not available for A3W (12" x 18") / B5R (7-1/4" x 10-1/2"R) / A5R (5-1/2" x 8-1/2"R). 	
Max. no. of stapled sheets (90 g/m ² (24 lbs.))	Max. no. of 100 sheets (A4 (8-1/2" x 11"), B5)	Max. no. of 50 sheets (A3 (11" x 17"), B4 (8-1/2" x 14"), A4R (8-1/2" x 11"R))
Staple position	1 bottom, 1 top, 2 middle	
Required power supply	AC 230V, 10A	
Dimensions	When output paper tray is stored (654 mm (W) x 765 mm (D) x 1040 mm (H)) 25-3/4" (W) x 30-1/8" (D) x 40-15/16" (H) When output paper tray is extended 782 mm (W) x 765 mm (D) x 1040 mm (H) (30-51/64" (W) x 30-1/8" (D) x 40-15/16" (H))	
Weight	Approx. 61 kg (134.5 lbs.)	

Saddle stitch finisher

MX-FN22

Name	Saddle Stitch Finisher (100-sheet stapling)	
Paper sizes	Depends on feeder specifications	
Useable paper	55 to 300 g/m ² Index (16 lbs. Bond to 170 lbs.)	
No. of trays	4	
	Upper tray	
	Non-stapled	A3W (13" x 19", 12" x 18") / A3 (11" x 17") / B4 (8-1/2" x 14"), SRA3: 750 sheets A4 (8-1/2" x 11") / A4R, B5 (8-1/2" x 11"R) / B5R (7-1/4" x 10-1/2"R) / A5R (5-1/2" x 8-1/2"R): 1,500 sheets
	Staple function	A3 (11" x 17") / B4 (8-1/2" x 14"): 50 units or 750 sheets A4 (8-1/2" x 11") / A4R, B5 (8-1/2" x 11"R): 100 units or 1,500 sheets
	Centre tray	
	Non-stapled	A3W (13" x 19", 12" x 18") / A3 (11" x 17") / B4 (8-1/2" x 14"), SRA3: 125 sheets A4 (8-1/2" x 11") / A4R (8-1/2" x 11"R), B5 / B5R (7-1/4" x 10-1/2"R) / A5R (5-1/2" x 8-1/2"R): 250 sheets
	Lower tray	
	Non-sort	A3W (13" x 19", 12" x 18") / A3 (11" x 17") / B4 (8-1/2" x 14"), SRA3: 750 sheets A4R (8-1/2" x 11"R) / B5R (7-1/4" x 10-1/2"R) / A5R (5-1/2" x 8-1/2"R): 1,500 sheets A4 / B5 / 8-1/2" x 11": 2,500 sheets
Tray capacity (21 lbs. (80 g/m ²))	Staple function	A3 (11" x 17") / B4 (8-1/2" x 14"): 50 units or 750 sheets A4 (8-1/2" x 11") / A4R, B5 (8-1/2" x 11"R): 100 units or 1,500 sheets
	Saddle stitch tray	
	Non-stapled	60 to 105 g/m ² (16 lbs. Bond to 28 lbs. Bond): 5 sheets
	Staple function	60 to 81.4 g/m ² (16 lbs. Bond to 21 lbs. Bond): 5 units (16 to 20 sheets), 10 units (11 to 15 sheets), 15 units (6 to 10 sheets), 25 units (1 to 5 sheets) 81.4 g/m ² over to 105 g/m ² (21 lbs. Bond over to 28 lbs. Bond): 15 units (6 to 10 sheets), 25 units (1 to 5 sheets)
	Staple function in cover mode	60 to 81.4 g/m ² (16 lbs. Bond to 21 lbs. Bond): 5 units (16 to 20 sheets), 10 units (11 to 15 sheets) 81.4 g/m ² over to 105 g/m ² (21 lbs. Bond over to 28 lbs. Bond): 10 units (1 to 10 sheets)
	<ul style="list-style-type: none"> Offset output is not available for A3W (12" x 18") / B5R (7-1/4" x 10-1/2"R) / A5R (5-1/2" x 8-1/2"R). 	
Max. no. of stapled sheets (24 lbs. (90 g/m ²))	Max. no. of 100 sheets (A4 (8-1/2" x 11"), B5)	Max. no. of 50 sheets (A3 (11" x 17"), B4 (8-1/2" x 14"), A4R (8-1/2" x 11"R))
Staple position	1 bottom, 1 top, 2 middle	
Staple method (for saddle stitch)	Centred fold with stapling in 2 centre places	
Saddle stitch fold position	Centred fold	
Saddle usable sizes	A3 (11" x 17") / B4 (8-1/2" x 14") / A4R (8-1/2" x 11"R) / A3W (12" x 18") 8K, 8-1/2" x 13-1/2", 8-1/2" x 13-2/5", 8-1/2" x 13"	
Saddle usable paper weight	60 g/m ² (16 lbs. Bond) to 300 g/m ² Index (170 lbs.) Paper weighting 106 g/m ² (28 lbs. Bond) to 300 g/m ² Index (170 lbs.) is only able to be used in cover mode and for single sheet fold.	
Max. no. of saddle-stitched sheets	Max. no. of 30 sheets (80 g/m ² (21 lbs.)): 29 sheets (80 g/m ² (21 lbs.)) + 1 sheet (256 g/m ² (68 lbs. Bond)) Max. no. of 20 sheets (90 g/m ² (24 lbs.)): 19 sheets (90 g/m ² (24 lbs.)) + 1 sheet (256 g/m ² (68 lbs. Bond))	
Required power supply	AC 230V, 10A	
Dimensions	When output paper tray is stored 767 mm (W) x 765 mm (D) x 1040 mm (H) (30-13/64" (W) x 30-1/8" (D) x 40-15/16" (H)) When output paper tray is extended 896 mm (W) x 765 mm (D) x 1040 mm (H) (35-9/32" (W) x 30-1/8" (D) x 40-15/16" (H))	
Weight	Approx. 108 kg (238.1 lbs.)	

Curl Correction Unit

Name	Curl Correction Unit (MX-RB15)
Paper size	Depends on feeder specifications
Useable paper	Depends on feeder specifications

Dimensions	214 mm (W) × 760 mm (D) × 986 mm (H) (8-7/16" (W) × 29-59/64" (D) × 38-13/16" (H))
Weight	16.4 kg (36.2 lbs)

Relay Unit

Name	Relay Unit (MX-RB13)
Dimensions	214 mm (W) × 760 mm (D) × 986 mm (H) (8-7/16" (W) × 29-59/64" (D) × 38-13/16" (H))

Weight	14.5 kg (32.0 lbs)
--------	--------------------

High Capacity Stacker

Name	High Capacity Stacker (MX-ST10)
Paper sizes	A3W (13" x 19") to 5-1/2" × A5R (8-1/2"R), SRA3, SRA4
Useable paper	55 to 300 g/m ² index (16 lbs bond to 170 lbs)
No. of trays	2
Tray capacity (21 lbs (80 g/m ²))	Upper tray A3W (13" x 19") to A5R (5-1/2" × 8-1/2"R) / SRA3 / SRA4: 250 sheets Lower tray * A3W (13" x 19", 12" x 18") / A3 (11" x 17") / B4 (8-1/2" × 14") / A4 (8-1/2" × 11") / A4R (8-1/2" × 11"R) / SRA3 / SRA4: 5,000 sheets B5 (7-1/4" × 10-1/2") / B5R (7-1/4" × 10-1/2"R) / A5R (5-1/2" × 8-1/2"R): 2,500 sheets

Required power supply	AC 100V-240V 50/60Hz
Dimensions	915 mm (W) × 758 mm (D) × 986 mm (H) (36-1/64" (W) × 29-27/32" (D) × 38-13/16" (H))
Weight	High Capacity Stacker: 100 kg (220 lbs) Cart: 15 kg (33 lbs)

* Do not load sheets of different sizes.

Punch module (MX-PN13A, MX-PN13B, MX-PN13C, MX-PN13D)

Name	Punch module	
	MX-PN13A, MX-PN13B, MX-PN13C, MX-PN13D	
Paper size for punch module	A3 (11" × 17") to B5R (7-1/4" × 10-1/2"R)	
Holes	MX-PN13A: 2 holes MX-PN13B: 3 holes	MX-PN13C: 4 holes MX-PN13D: 4 holes (wide)

Required power supply	Supplied from finisher/saddle stitch finisher
Dimensions	95 mm (W) × 715 mm (D) × 392 mm (H) (3-3/4" (W) × 28-9/64" (D) × 9-7/16" (H))
Weight	Approx. 3.7 kg (8.6 lbs.)

Network Printer Specifications

Type	Built-in type
Continuous print speed	Same as continuous copy speed
Resolution	Data processing: 600 × 600 dpi, 1,200 × 1,200 dpi Print: 600 × 600 dpi, equivalent to 9,600 dpi × 600 dpi, 1,200 × 1,200 dpi
Page description language	Standard: PCL6 emulation, Adobe® PostScript®3
Compatible protocols	TCP/IP (IPv4/IPv6), IPX/SPX, IPP, EtherTalk
Compatible OS	Windows XP, Windows Server 2003, Windows Vista, Windows Server 2008, Windows 7, Windows Server 2008R2, Windows 8, Windows Server 2012* Macintosh (Mac OS x 10.4 to 10.8)

Internal fonts (options)	80 fonts for PCL, 136 fonts for Adobe® PostScript®3
Memory	Machine system memory and hard disk
Interface	10BASE-T/100BASE-TX/1000BASE-T, USB 1.1, USB 2.0 (high speed mode)

* There are cases when a connection cannot be established. Please contact your local dealer for more information.

Network Scanner Specifications

Type	Colour scanner	
Scan resolution (main × vertical)	100 × 100 dpi, 150 × 150 dpi, 200 × 200 dpi, 300 × 300 dpi, 400 × 400 dpi, 600 × 600 dpi (push scan) 50 to 9,600 dpi *1 (pull scan)	
Scan speed (8-1/2" × 11" (A4))	B/W: 75 sheets/minute (one-sided) Colour: 75 sheets/minute (one-sided)	● When in standard mode using Sharp standard paper (A4 (8-1/2" × 11") size with 6% coverage) and the auto colour detector is turned off. The speed varies depending on the data volume of the original.
Interface	10BASE-T/100BASE-TX/1000BASE-T, USB 2.0 (during USB memory scanning)	
Compatible protocols	TCP/IP (IPv4)	
Compatible OS *2	Pull scan (TWAIN)	Windows XP, Windows Server 2003, Windows Vista, Windows Server 2008, Windows 7, Windows Server 2008R2 *2, Windows 8, Windows Server 2012

Output format	(B/W) TIFF, PDF, PDF/A, encrypted PDF, XPS *3 Compression method: decompression, G3 (MH), G4 (MMR) (Grey scale/colour) TIFF, JPEG, PDF, PDF/A, encrypted PDF, high compression PDF, XPS *3 Compression method: JPEG (high, mid, and low compression, Emphasis black letter)
Driver	TWAIN compliant

*1: You must decrease the scan size when increasing the resolution.

*2: There are cases when a connection cannot be established. Please contact your local dealer for more information.

*3: XPS (XML Paper Specification)

Trimming Module

Name	Trimming module (MX-TM10)	
Useable size for trimming module	A3W (13" × 19", 12" × 18"), A3, B4, A4R, 8K, 11" × 17", 8-1/2" × 14", 8-1/2" × 13-1/2", 8-1/2" × 13-2/5", 8-1/2" × 13", 8-1/2" × 11"R, SRA3	
Max. no. of sheets to be trimmed	2 to 20 sheets (60 g/m ² to 81.4 g/m ² (16 lbs. Bond to 21 lbs. Bond)) 2 to 10 sheets (81.4 g/m ² over to 105 g/m ² (21 lbs. Bond over to 28 lbs. Bond)) 2 to 3 sheets (105 g/m ² over to 220 g/m ² Index (28 lbs. Bond over to 56 lbs.)) • When plain paper trimmed. Including one front cover of 300 g/m ² Index (170 lbs.) or less.	

Required power supply	Supplied from saddle stitch finisher
Dimensions	251 mm (W) × 625 mm (D) × 403 mm (H) (9-7/8" (W) × 24-15/32" (D) × 15-7/8" (H))
Weight	Approx. 32 kg (70.6 lbs.)

Folding Unit

Name	Folding unit (MX-FD10)
Folding types	Z-Fold, C-Fold, Accordion Fold, Double Fold, Half Fold.
Useable size for folding unit	Z-Fold: A3, B4, A4R, 11" x 17", 8-1/2" x 14", 8-1/2" x 11"R C-Fold, Accordion Fold, Double Fold, Half Fold: A4R, 8-1/2" x 11"R
Useable paper	55 g/m ² to 105 g/m ² (16 lbs. Bond to 28 lbs. Bond))

Tray capacity (80 g/m ² (21 lbs.))	C-Fold/Accordion Fold/Double Fold 60 mm (2-23/64") (Equivalent to 40 sheets. (Equivalent to 25 sheets for Double Fold)) • Copies made in Z-Fold or Half Fold are output to the tray of the finisher (large stacker) or saddle stitch finisher (large stacker).
Required power supply	Supplied from finisher / saddle stitch finisher
Dimensions	336 mm (W) x 770 mm (D) x 1050 mm (H) (13-15/32" (W) x 30-5/16" (D) x 41-11/32" (H))
Weight	Approx. 66 kg (145.5 lbs.)

Inserter

Name	Inserter (MX-CF11)
Useable size for inserter	A3W (13" x 19", 12" x 18"), A3, B4, A4, A4R, B5, B5R, A5R, SRA3, SRA4, 8K, 16K, 16KR, 11" x 17", 8-1/2" x 14", 8-1/2" x 13-1/2", 8-1/2" x 13-2/5", 8-1/2" x 13", 8-1/2" x 11", 8-1/2" x 11"R, 7-1/4" x 10-1/2"R, 5-1/2" x 8-1/2"R, A4W(9" x 12")
Useable paper	60 g/m ² to 220 g/m ² Cover (16 lbs. Bond to 80 lbs.)
No. of trays	2

Tray capacity (80 g/m ² (21 lbs.))	Upper tray: 200 sheets Lower tray: 200 sheets
Required power supply	Supplied from the machine
Dimensions	540 mm (W) x 760 mm (D) x 1276 mm (H) (21-17/64" (W) x 29-59/64" (D) x 50-7/32" (H))
Weight	Approx. 45 kg (99.2 lbs.)

Noise emission

Noise emission values

The following shows noise emission values as measured according to ISO7779.

Sound power level L_{WA}d

	MX-6500N	MX-7500N
Operating (continuous printing)	7.77 B	7.80 B
Standby (low power level mode)	-	

Sound pressure level L_{pAm}

		MX-6500N/MX-7500N
Operating (continuous printing)	Bystander positions	60 dB
Standby (low power level mode)	Bystander positions	-



- Operating: With options MX-FN21, MX-RB12, MX-RB15, and MX-MF10.
- Standby: " - " = less than background noise.

SUPPLIES

Standard supplies for this product that can be replaced by the user include paper, toner cartridges, and staple cartridges for the finisher.

Be sure to use only SHARP-specified products for the toner cartridges, finisher staple cartridge, and transparency film.

SHARP



For best copying results, be sure to use only Sharp Genuine Supplies which are designed, engineered, and tested to maximize the life and performance of Sharp products. Look for the Genuine Supplies label on the toner package.

GENUINE SUPPLIES

Storage of supplies

Proper storage

1. Store the supplies in a location that is:
 - clean and dry,
 - at a stable temperature,
 - not exposed to direct sunlight.
2. Store paper in the wrapper and lying flat.
3. Paper stored in packages standing up or out of the wrapper may curl or become damp, resulting in paper misfeeds.

Storing toner cartridges

Store a new toner cartridge box horizontally with the top side up. Do not store a toner cartridge standing on end. If stored standing on end, the toner may not distribute well even after shaking the cartridge vigorously, and will remain inside the cartridge without flowing out.

Staple cartridge

The finisher and saddle finisher require the following staple cartridge:

MX-SCX1 (for saddle stitch of saddle stitch finisher (large stacker))

Approx. 5000 per cartridge x 3 cartridges

MX-SCX2 (for finisher (large stacker) and saddle stitch finisher (large stacker))

Approx. 5000 per cartridge 3 cartridges

Supply of spare parts and consumables

The supply of spare parts for repair of the machine is guaranteed for at least 7 years following the termination of production. Spare parts are those parts of the machine which may break down within the scope of the ordinary use of the product, whereas those parts which normally exceed the life of the product are not to be considered as spare parts. Consumables too, are available for 7 years following the termination of production.

Forwarding all sent data to the administrator (document administration function)

This function is used to forward all data sent by the machine to a specified destination (Scan to E-mail address, Scan to FTP destination, or Scan to Network Folder destination). This function can be used by the administrator of the machine to archive all sent data. To configure the document administration settings, click [Application Settings] and then [Document Administration Function] in "Settings mode". (Administrator rights are required.)



The forwarding data, exposure, and resolution settings of sent data remain in effect.

Setting mode password

An administrator password is required to configure the machine settings using administrator rights.

The settings can be configured from either the operation panel or by using a computer web browser.

After setting up the machine, refer to "Settings mode" in the User's Manual to set a new password.



The same administrator password is used for the operation panel and the Web page. If the administrator changes a password on the operation panel, the password will be valid when logging in to the Web page.

Password for logging in from a computer

As factory default, "Administrator" is the only account allowed to log in from a Web browser. By setting user authentication, "System Administrator" will also be allowed to log in from the Web browser. You can also specify a device account as a login user. The factory default passwords for respective accounts are shown in the following. Logging in as an "Administrator" or "System Administrator" allows you to manage all the settings available via Web browser.

	Account	Password
User	user	users
Administrator	admin	admin
System administrator	sysadmin	sysadmin



Do not forget the new administrator password.

SIZES AND TYPES PAPER THAT CAN BE SET IN EACH TRAY

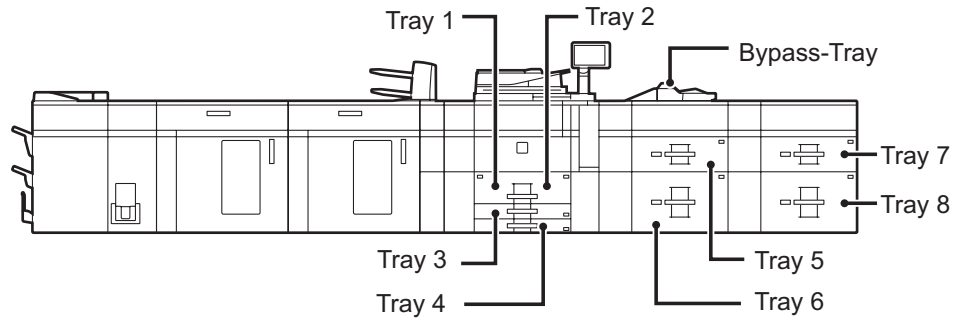

		Tray 1	Tray 2	Tray 3	Tray 4	Bypass Tray (MX-MF10)	MX-LC13				Bypass Tray (MX-MF11)	Tray 5 (MX-LCX3 N)	Tray 5 (MX-LC12)
							Tray 5	Tray 6	Tray 7	Tray 8			
Min. Paper Weight		60g/m ² (16lbs.Bond)	60g/m ² (16lbs.Bond)	60g/m ² (16lbs.Bond)	60g/m ² (16lbs.Bond)	55g/m ² (16lbs.Bond)	55g/m ² (16lbs.Bond)	55g/m ² (16lbs.Bond)	55g/m ² (16lbs.Bond)	55g/m ² (16lbs.Bond)	60g/m ² (16lbs.Bond)	60g/m ² (16lbs.Bond)	60g/m ² (16lbs.Bond)
Max. Paper Weight		105g/m ² (28lbs.Bond)	105g/m ² (28lbs.Bond)	220g/m ² (58lbs)	220g/m ² (58lbs)	300g/m ² (79lbs)	300g/m ² (79lbs)	300g/m ² (79lbs)	300g/m ² (79lbs)	300g/m ² (79lbs)	220g/m ² (58lbs)	220g/m ² (58lbs)	220g/m ² (58lbs)
Paper Type	Thin Paper	No	No	No	No	Yes	Yes	Yes	Yes	Yes	Yes	No	No
	Plain (60-105g/m ² (16lbs.Bond to 28lbs.Bond))	Yes	Yes	Yes	Yes	Yes	Yes	Yes	Yes	Yes	Yes	Yes	Yes
	Recycled	Yes	Yes	Yes	Yes	Yes	Yes	Yes	Yes	Yes	Yes	Yes	Yes
	Colour	Yes	Yes	Yes	Yes	Yes	Yes	Yes	Yes	Yes	Yes	Yes	Yes
	Letter Head	Yes	Yes	Yes	Yes	Yes	Yes	Yes	Yes	Yes	Yes	Yes	Yes
	Pre-Printed	Yes	Yes	Yes	Yes	Yes	Yes	Yes	Yes	Yes	Yes	Yes	Yes
	Pre-Punched	Yes	Yes	Yes	Yes	Yes	Yes	Yes	Yes	Yes	Yes	Yes	Yes
	Heavy Paper 1 (106-176g/m ² (28lbs to 46lbs))	No	No	Yes	Yes	Yes	Yes	Yes	Yes	Yes	Yes	Yes	Yes
	Heavy Paper 2 (177-220g/m ² (47lbs to 58lbs))	No	No	Yes	Yes	Yes	Yes	Yes	Yes	Yes	Yes	Yes	Yes
	Heavy Paper 3 (221-256g/m ² (59lbs to 68lbs))	No	No	No	No	Yes	Yes	Yes	Yes	Yes	No	No	No
	Heavy Paper 4 (257-300g/m ² (69lbs to 79lbs))	No	No	No	No	Yes	Yes	Yes	Yes	Yes	No	No	No
	Embossed	No	No	No	Yes	Yes	Yes	Yes	Yes	Yes	No	No	No
	Tab Paper	No	No	No	Yes	Yes	Yes	Yes	Yes	Yes	Yes	No	No
	Transparency	No	No	No	Yes	Yes	Yes	Yes	Yes	Yes	Yes	No	No
	Labels	No	No	No	Yes	Yes	Yes	Yes	Yes	Yes	No	No	No
Glossy Paper	No	No	No	No	Yes	Yes	Yes	Yes	Yes	No	No	No	
User Type 1-11	Yes	Yes	Yes	Yes	Yes	Yes	Yes	Yes	Yes	Yes	Yes	Yes	
Paper Size	330mm x 483mm	13" x 19"	No	No	No	Yes	Yes	Yes	Yes	Yes	Yes	Yes	No
	305mm x 457mm	A3W (12" x 18")	No	No	Yes	Yes	Yes	Yes	Yes	Yes	Yes	Yes	No
	279mm x 432mm	11" x 17"	No	No	Yes	Yes	Yes	Yes	Yes	Yes	Yes	Yes	No
	216mm x 356mm	8-1/2" x 14"	No	No	Yes	Yes	Yes	Yes	Yes	Yes	Yes	Yes	No
	216mm x 343mm	8-1/2" x 13-1/2"	No	No	Yes	Yes	Yes	Yes	Yes	Yes	Yes	No	No
	216mm x 340mm	8-1/2" x 13-2/5"	No	No	Yes	Yes	Yes	Yes	Yes	Yes	Yes	No	No
	216mm x 330mm	8-1/2" x 13"	No	No	Yes	Yes	Yes	Yes	Yes	Yes	Yes	Yes	No
	279mm x 216mm	8-1/2" x 11"	Yes	Yes	Yes	Yes	Yes	Yes	Yes	Yes	Yes	Yes	Yes

		Tray 1	Tray 2	Tray3	Tray 4	Bypass Tray (MX-MF10)	MX-LC13				Bypass Tray (MX-MF11)	Tray 5 (MX-LCX3 N)	Tray 5 (MX-LC12)
							Tray 5	Tray 6	Tray 7	Tray 8			
Paper Size	216mm x279mm	8-1/2" x 11"R	No	No	Yes	Yes	Yes	Yes	Yes	Yes	Yes	Yes	No
	140mm x 216mm	5-1/2" x 8-1/2"R	No	No	No	Yes	Yes	No	No	No	No	Yes	No
	184mm x 266mm	7-1/4" x 10-1/2"R	No	No	Yes	Yes	Yes	Yes	Yes	Yes	Yes	Yes	No
	305mm x 229mm	A4W (9" x 12")	No	No	Yes	Yes	Yes	Yes	Yes	Yes	Yes	Yes	No
	A3	297mm x 420mm	No	No	Yes	Yes	Yes	Yes	Yes	Yes	Yes	Yes	No
	B4	257mm x 364mm	No	No	Yes	Yes	Yes	Yes	Yes	Yes	Yes	Yes	No
	A4	297mm x 210mm	Yes	Yes	Yes	Yes	Yes	Yes	Yes	Yes	Yes	Yes	Yes
	A4-R	210mm x 297mm	No	No	Yes	Yes	Yes	Yes	Yes	Yes	Yes	Yes	No
	B5	257mm x 182mm	Yes	No	Yes	Yes	Yes	Yes	Yes	Yes	Yes	Yes	Yes
	B5-R	182mm x 257mm	No	No	Yes	Yes	Yes	Yes	Yes	Yes	Yes	Yes	No
	A5-R	148mm x 210mm	No	No	No	Yes	Yes	No	No	No	No	Yes	No
	SRA3	320mm x 450mm	No	No	No	No	Yes	Yes	Yes	Yes	Yes	Yes	No
	SRA4	320mm x 225mm	No	No	No	No	Yes	Yes	Yes	Yes	Yes	Yes	No
	8K	270mm x 390mm	No	No	Yes	Yes	Yes	Yes	Yes	Yes	Yes	Yes	No
	16K	270mm x 195mm	No	No	Yes	Yes	Yes	Yes	Yes	Yes	Yes	Yes	No
	16K-R	195mm x 270mm	No	No	Yes	Yes	Yes	Yes	Yes	Yes	Yes	Yes	No
	Monarch	98mm x 191mm	No	No	No	No	Yes	No	No	No	No	No	No
	COM10	105mm x 241mm	No	No	No	No	Yes	No	No	No	No	No	No
	DL	110mm x 220mm	No	No	No	No	Yes	No	No	No	No	No	No
	C5	229mm x 162mm	No	No	No	No	Yes	No	No	No	No	No	No
Extra- Custom Size		No	No	No	Yes	Yes	Yes	Yes	Yes	Yes	Yes	No	No
Custom Range	Min X	No	No	No	148mm /5.875inch	140mm /5.5inch	182mm /7.2inch	182mm /7.2inch	182mm /7.2inch	182mm /7.2inch	140mm /5.5inch	No	No
	Max X	No	No	No	457mm /18inch	488mm /19.2inch	488mm /19.2inch	488mm /19.2inch	488mm /19.2inch	488mm /19.2inch	488mm /19.2inch	No	No
	Min Y	No	No	No	100mm /4inch	90mm /3.625inch	182mm /7.2inch	182mm /7.2inch	182mm /7.2inch	182mm /7.2inch	100mm /4inch	No	No
	Max Y	No	No	No	305mm /12inch	330mm /13inch	330mm /13inch	330mm /13inch	330mm /13inch	330mm /13inch	330mm /13inch	No	No
Extra- Size Unknown		No	No	No	No	Yes	No	No	No	No	No	No	No
Long Size	Width: 90mm-305mm (5.5inch-12inch) Length: 458mm-1200mm (18inch-47.244inch)	No	No	No	No	Yes	No	No	No	No	Yes	No	No

Canceling an operation and redoing settings

To change a setting or cancel printing, follow these steps:

To restore all settings to the default settings

Tap the [CA] key.

To cancel printing or transmission

Tap the [Cancel Print] or [Sending Canceled] key, or delete the job being executed in the [Job Management] screen.

To cancel a job

Delete the job waiting in the [Job Management] screen.

To redo entry of a numeric value

Tap the [C] key.

When a problem occurs

If a problem occurs while using the machine, check the following:

Only problems that occur frequently are described here. For other problems, refer to Troubleshooting in the User's Guide.

Some or all functions cannot be used

<p>Have functions been disabled by the administrator?</p>	<p>Some functions may have been disabled in the setting mode. Check with your administrator. When user authentication is enabled, the functions that you can use may be restricted in your user settings. Check with your administrator.</p>
--	--

Colours are off

<p>Did you perform [Registration Adjustment]?</p>	<p>Ask your administrator to perform [Registration Adjustment]. => "Setting mode (administrator)" → [System Settings] → [Device Control] → [Registration Adjustment "Execute"] button. If the colour tones are off, perform [Auto Colour Calibration] after finishing registration adjustment. (If the colours are still off after calibration, repeating calibration may improve the results.) Copy mode: => "Setting mode (administrator)" → [System Settings] → [Copy Settings] → [Colour Adjust] → [Auto Colour Calibration]. Printer mode: => "Setting mode (administrator)" → [System Settings] → [Printer Settings] → [Auto Colour Calibration].</p>
--	--

Auto selection of colour mode does not take place correctly

<p>Are you scanning one of the following types of originals?</p>	<p>When Black & White cannot be selected:</p> <ul style="list-style-type: none"> • Are there colors or colouring in the paper? <p>When Colour cannot be selected:</p> <ul style="list-style-type: none"> • Is the colour in the original very light? • Is the colour in the original very dark, almost black? • Is only a very small area of the original coloured? <p>In this event, specify the colour mode manually.</p>
---	---

Line appear in the scanned image

<p>Are the scanning areas of the document glass or automatic document feeder dirty?</p>	<p>Clean the scanning areas of the document glass or automatic document feeder.</p>
--	---

Machine can not to be send or transmitted to computer

Is your PC connected correctly to the machine?	Make sure that the cable is connected securely to the LAN connector or the USB port of your PC and that of the machine. If you are connected to a network, make sure that the LAN cable is securely connected to the hub as well.
Is the IP address selected correctly?	Check the IP address setting. If the machine does not have a permanent IP address (the machine receives an IP address from a DHCP server), printing will not be possible if the IP address changes. To check the IP address of this machine, select "Setting mode" → [System Settings] → "All Custom Setting List", and print the setting. If the IP address is changed, reconfigure the port setting for the printer driver. => "Setting mode" → [System Settings] → [List Print (User)] → [All Custom Setting List]. See also the Software Setup Guide. If the IP address changes frequently, it is recommended that a permanent IP address be assigned to the machine. => "Setting mode (administrator)" → [Network Settings]

Transmission does not take place

Did you select the correct destination? Is the correct information (e-mail address or FTP server information) stored for that destination?	Make sure that the correct information is stored for the destination and that the destination is correctly selected. If delivery by e-mail (Scan to E-mail) is unsuccessful, an error message such as "Undelivered Message" may be sent to the designated administrator's e-mail address. This information may help you determine the cause of the problem.
---	--

The fold position is not correct

Is the original placed face up or face down correctly?	Check the orientation for loading the original or the orientation of the paper to be folded, and take appropriate actions.
Are you using a paper type that has a specific front and reverse side?	The paper folding function cannot be used with pre-printed paper, letterhead paper, or other paper that has specific front or reverse sides. When folding paper, use a paper type such as plain paper that does not have specific front or reverse sides.

The paper misfeeds

Is a torn piece of paper remaining in the machine?	Make sure all paper is removed.
---	---------------------------------

MX-6500N/MX-7500N

QUICK START GUIDE

SHARP®

SHARP CORPORATION

PRINTED IN FRANCE

TINSE5198GHZZ

