

SHARP®

DIGITAL FULL COLOUR MULTIFUNCTIONAL SYSTEM

User's Manual

MODEL : MX-2630N MX-4070V
 MX-3050V MX-5050V
 MX-3060V MX-5070V
 MX-3070V MX-6050V
 MX-3550V MX-6070V
 MX-3560V
 MX-3570V
 MX-4050V
 MX-4060V

Click to jump to the table of contents of the desired chapter.



BEFORE USING THE MACHINE

Functions of the machine and procedures for placing originals and loading paper



COPIER

Using the copy function



PRINTER

Using the printer function



FACSIMILE

Using the fax function



SCANNER / INTERNET FAX

Using the scan / Internet fax function



DOCUMENT FILING

Storing jobs as files on the hard drive



SYSTEM SETTINGS

Configuring settings to make the machine easier to use



HOW TO USE THIS MANUAL

Click a button below to move to the page that you wish to view.

The following explanation assumes that Adobe Reader XI is being used (Some buttons do not appear in the default state.).

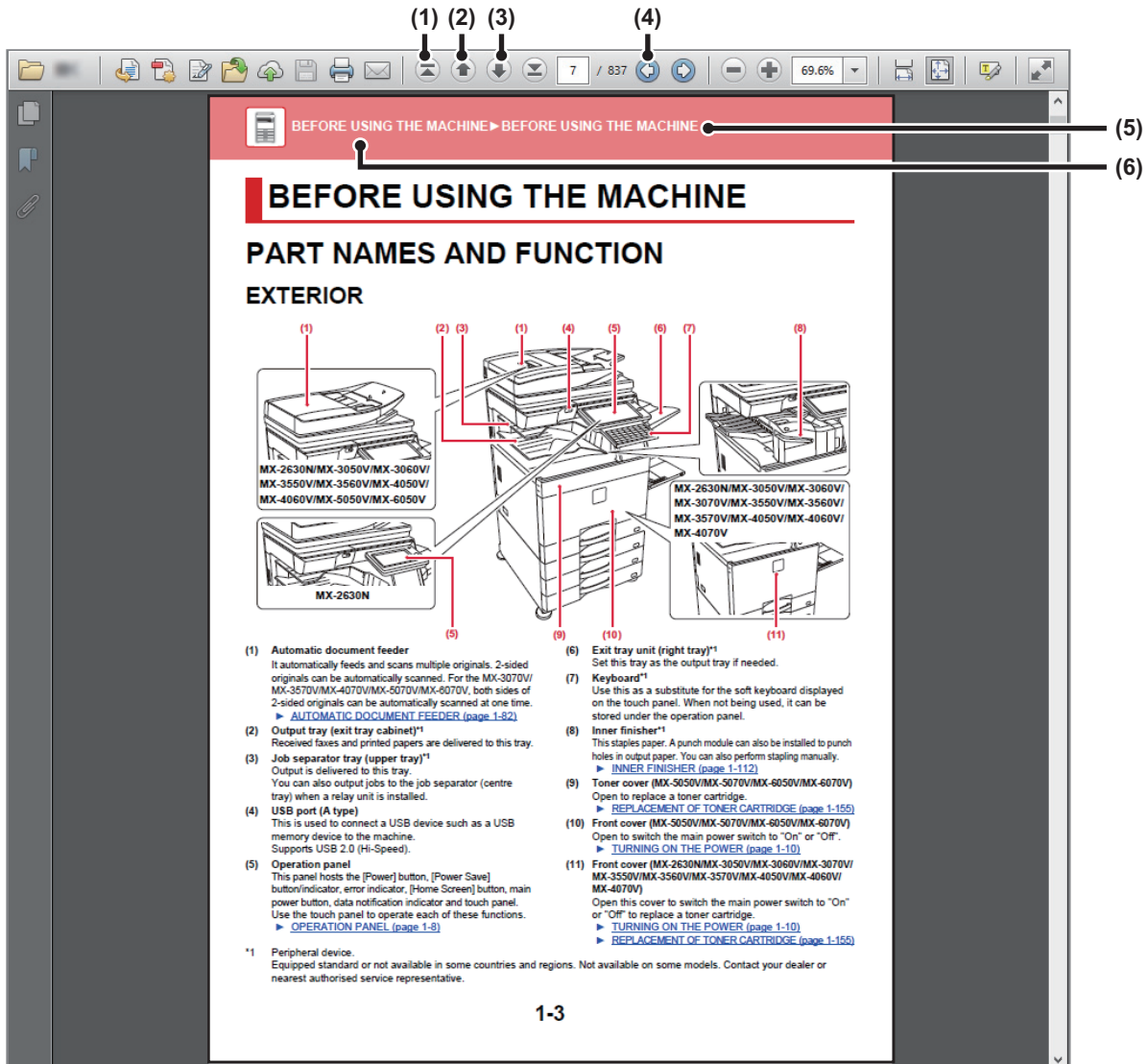

(1) Return to top page button

If an operation does not proceed as expected, click this button to start over again.

(2) Back one page button

Displays the previous page.

(3) Forward one page button

Displays the next page.

(4) Return to previously displayed page button

Displays the page that was displayed before the current page.

(5) Title button

Displays the page of the title indicated by the button.

(6) Contents button

Displays the contents of each chapter. For example, if the current page is part of the printer chapter, the table of contents of the printer chapter appears.



If a button does not appear, refer to Adobe Reader Help to display the button.

ABOUT OPERATION MANUAL

This manual explains how to use the MX-2630N/MX-3050V/MX-3060V/MX-3070V/MX-3550V/MX-3560V/MX-3570V/MX-4050V/MX-4060V/MX-4070V/MX-5050V/MX-5070V/MX-6050V/MX-6070V digital full colour multifunctional system.

Please note

- For information on installing the drivers and software cited in this manual, please refer to the Software Setup Guide.
- For information on your operating system, please refer to your operating system manual or the online Help function.
- The explanations of screens and procedures in a Windows environment are primarily for Windows® 8.1. The screens may be different depending on the version of the operating system or the software application.
- The explanations of screens and procedures in a Macintosh environment are based on Mac OS X v10.10 in the case of Mac OS X. The screens may be different depending on the version of the operating system or the software application.
- Wherever "MX-xxxx" appears in this manual, please substitute your model name for "xxxx".
- This manual contains references to the fax function. However, please note that the fax function is not available in some countries and regions.
- Considerable care has been taken in preparing this manual. If you have any comments or concerns about the manual, please contact your dealer or nearest authorised service representative.
- This product has undergone strict quality control and inspection procedures. In the unlikely event that a defect or other problem is discovered, please contact your dealer or nearest authorised service representative.
- Aside from instances provided for by law, SHARP is not responsible for failures occurring during the use of the product or its options, or failures due to incorrect operation of the product and its options, or other failures, or for any damage that occurs due to use of the product.

Warning

- Reproduction, adaptation or translation of the contents of the manual without prior written permission is prohibited, except as allowed under copyright laws.
- All information in this manual is subject to change without notice.





Illustrations and the operation panel and touch panel shown in this manual

The peripheral devices are generally optional, however, some models include certain peripheral devices as standard equipment. The explanations in this manual assume that a paper drawer is installed on the MX-6070V. For some functions and procedures, the explanations assume that devices other than the above are installed.

The display screens, messages, and key names shown in the manual may differ from those on the actual machine due to product improvements and modifications.

Icons used in the manuals

The icons in the manuals indicate the following types of information:

	This alerts you to a situation that could result in death or serious personal injury. This alerts you to a situation that could result in personal injury or damage to properties.		This explains how to stop or correct an operation.
	This alerts you to a situation where there is a risk of machine damage or failure.		This describes a routine work relevant to setting mode.
	This supplements function or operation procedure.		



BEFORE USING THE MACHINE

BEFORE USING THE MACHINE

PART NAMES AND FUNCTION	1-3
• EXTERIOR	1-3
• INTERIOR	1-5
• AUTOMATIC DOCUMENT FEEDER AND DOCUMENT GLASS	1-6
• SIDE AND BACK	1-7
• OPERATION PANEL	1-8
TURNING ON THE POWER	1-10
TOUCH PANEL	1-11
• TOUCH TYPES	1-11
• HOME SCREEN	1-14
• PREVIEW SCREEN	1-17
• OPERATION OF FREQUENTLY USED KEYS ...	1-23
• ACTION PANEL	1-24
• CONFIRMATION SCREEN FOR FAVOURITE MENUS AND SETTINGS	1-24
Eco	1-26
• ECO FUNCTIONS OF THE MACHINE	1-26
• AUTO POWER SHUT-OFF MODE	1-27
• PREHEAT MODE	1-28
• ECO RECOMMENDATION FUNCTION DISPLAY	1-28
• AS SOON AS THE REMOTE JOB IS FINISHED, ENTER AUTO POWER SHUT OFF MODE	1-29
• ECO SCAN	1-29
• POWER ON/OFF SCHEDULE SETTING	1-30
• SPECIFIC DATE OPERATION SETTINGS ...	1-30
• MOTION SENSOR (MX-3060V/MX-3070V/MX-3560V/ MX-3570V/MX-4060V/MX-4070V/MX-5070V/M X-6070V only)	1-31
USER AUTHENTICATION	1-32
• AUTHENTICATION BY USER NUMBER	1-32
• AUTHENTICATION BY LOGIN NAME/PASSWORD	1-34
• ACTIVE DIRECTORY LINKING FUNCTION. ...	1-37
BILLING CODE	1-40
• BILLING CODE	1-40
• USE BILLING CODE	1-41
• REGISTERING A NEW BILLING CODE	1-44

• EDITING OR DELETING THE REGISTERED BILLING CODE	1-47
CLOUD LINK	1-50
• BEFORE USING THE CLOUD LINK FUNCTION	1-50
• UPLOADING SCANNED DATA TO A CLOUD SERVICE	1-51
• PRINTING DATA IN A CLOUD SERVICE ...	1-51
AirPrint	1-53
EASY CONNECTION WITH A MOBILE DEVICE (EASY CONNECT)	1-55
• CONNECTING BY NFC CARD READER ...	1-55
• CONNECTING BY QR CODE	1-56
NAS	1-57
REMOTE OPERATION OF THE MACHINE	1-59
UNIVERSAL DESIGN IN THE MACHINE	1-60
• UNIVERSAL DESIGN RELATED TO OPERATION	1-60
• UNIVERSAL DESIGN RELATED TO VISION ...	1-61
• UNIVERSAL DESIGN RELATED TO HEARING ...	1-61
• UNIVERSAL DESIGN FEATURES	1-62
ITEMS RECORDED IN THE JOB LOG	1-64

LOADING PAPER

IMPORTANT POINTS ABOUT PAPER	1-67
• NAMES AND LOCATIONS OF TRAYS	1-67
• THE DEFINITION OF "R" IN PAPER SIZE ...	1-67
• APPLICABLE PAPER TYPES	1-68
TRAY 1 - 4 (when a low stand/550 sheet paper drawer or stand/550/2x550/3x550/ 550&2100 sheet paper drawer is installed)	1-71
TRAY 3 - 4 (when a stand/550&2100 sheet paper drawer is installed)	1-74
LOADING PAPER IN THE LARGE-CAPACITY TRAY (when a large capacity tray is installed) ..	1-76
LOADING PAPER INTO THE BYPASS TRAY	1-78
HOW TO PLACE THE LONG PAPER GUIDE	1-82





HOW TO PLACE THE ORIGINAL

SELECTING A PROCEDURE FOR PLACING THE ORIGINAL DEPENDING ON THE TYPE AND STATUS OF THE ORIGINAL 1-83

AUTOMATIC DOCUMENT FEEDER 1-84

DOCUMENT GLASS 1-86

STOPPING/DELETING A JOB, PRIORITY PROCESSING AND CHECKING THE STATUS

TYPES OF JOB STATUS SCREENS 1-88

STOPPING/DELETING A JOB IN PROGRESS OR RESERVED 1-90

PRIORITY PROCESSING OF A RESERVED JOB ... 1-91

CHECKING A RESERVED JOB OR THE JOB IN PROGRESS 1-93

CHECKING COMPLETED JOBS 1-94

READING THE JOB LIST 1-95

ADDRESS BOOK

ADDRESS BOOK 1-98

ADDRESS BOOK SCREEN 1-99

STORING ADDRESSES THROUGH DIRECT ENTRY 1-102

STORING ADDRESSES THROUGH GLOBAL ADDRESS SEARCH 1-103

STORING ADDRESSES FROM FAX OR IMAGE SEND LOGS 1-105

STORING GROUPS 1-106

EDITING/DELETING ADDRESSES IN ADDRESS BOOK 1-108

SETTING THE SCOPE FOR PUBLICIZING CONTACTS AND GROUPS 1-110

DELETING THE TRANSMISSION HISTORY 1-111

PERIPHERAL DEVICES

PERIPHERAL DEVICES 1-112

INNER FINISHER 1-114

- PART NAMES 1-114
- HOW TO STAPLE MANUALLY 1-115
- SUPPLIES 1-116
- INNER FINISHER MAINTENANCE 1-116

FINISHER 1-118

- PART NAMES 1-118
- SUPPLIES 1-119
- FINISHER MAINTENANCE 1-119

FINISHER (LARGE STACKER) 1-121

- PART NAMES 1-121
- HOW TO STAPLE MANUALLY 1-122
- SUPPLIES 1-123
- FINISHER (LARGE STACKER) MAINTENANCE 1-123

SADDLE STITCH FINISHER 1-125

- PART NAMES 1-125
- SUPPLIES 1-126
- SADDLE STITCH FINISHER MAINTENANCE ... 1-126

SADDLE STITCH FINISHER (LARGE STACKER) 1-129

- PART NAMES 1-129
- HOW TO STAPLE MANUALLY 1-130
- SUPPLIES 1-131
- SADDLE STITCH FINISHER (LARGE STACKER) MAINTENANCE 1-131

PUNCH MODULE 1-135

- DISCARDING PUNCH WASTE 1-135

Sharp OSA 1-141

- APPLICATION COMMUNICATION 1-141
- EXTERNAL ACCOUNT APPLICATION 1-142

REMOVING MISFEEDS

REMOVING MISFEEDS 1-144

MAINTENANCE

REGULAR MAINTENANCE 1-145

- CLEANING THE DOCUMENT GLASS AND AUTOMATIC DOCUMENT FEEDER 1-145
- CLEANING THE MAIN CHARGER OF THE PHOTOCONDUCTIVE DRUM 1-148
- CLEANING THE PT CHARGER OF THE PRIMARY TRANSFER BELT 1-151
- CLEANING THE LASER UNIT 1-153
- CLEANING THE BYPASS FEED ROLLER ... 1-156
- CLEANING THE PAPER FEED ROLLER (MX-2630N/MX-3050V/MX-3060V/MX-3550V/MX-3560V/MX-4050V/MX-4060V/MX-5050V/MX-6050V only) 1-156

REPLACEMENT OF TONER CARTRIDGE 1-157

REPLACING THE WASTE TONER BOX 1-161

REPLACING THE STAMP CARTRIDGE 1-162

CHARACTER ENTRY

NAMES AND FUNCTIONS OF SOFT KEYBOARD KEYS 1-165



BEFORE USING THE MACHINE

PART NAMES AND FUNCTION

EXTERIOR

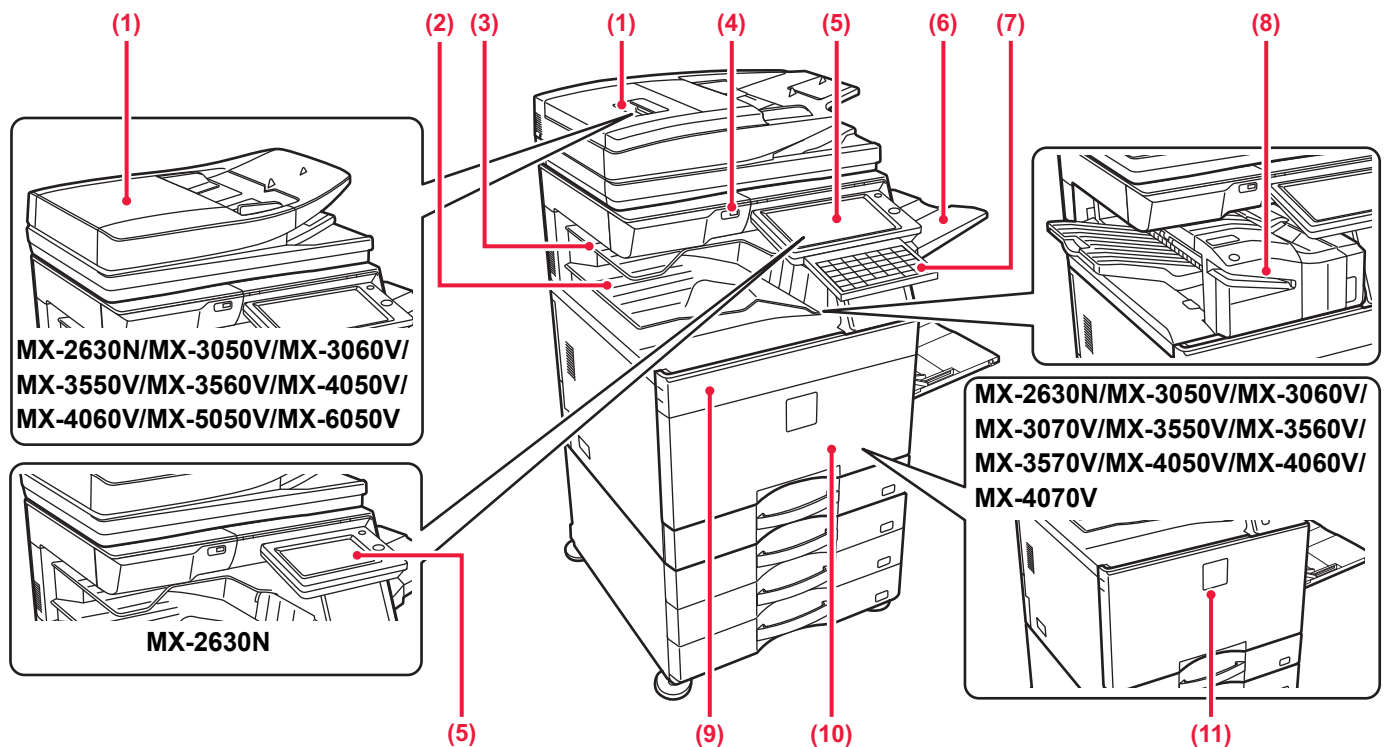

- (1) **Automatic document feeder**
It automatically feeds and scans multiple originals. 2-sided originals can be automatically scanned. For the MX-3070V/MX-3570V/MX-4070V/MX-5070V/MX-6070V, both sides of 2-sided originals can be automatically scanned at one time.
► [AUTOMATIC DOCUMENT FEEDER \(page 1-84\)](#)
- (2) **Output tray (exit tray cabinet)*1**
Received faxes and printed papers are delivered to this tray.
- (3) **Job separator tray (upper tray)*1**
Output is delivered to this tray.
You can also output jobs to the job separator (centre tray) when a relay unit is installed.
- (4) **USB port (A type)**
This is used to connect a USB device such as a USB memory device to the machine.
Supports USB 2.0 (Hi-Speed).
- (5) **Operation panel**
This panel hosts the [Power] button, [Power Save] button/indicator, error indicator, [Home Screen] button, main power button, data notification indicator and touch panel.
Use the touch panel to operate each of these functions.
► [OPERATION PANEL \(page 1-8\)](#)
- (6) **Exit tray unit (right tray)*1**
Set this tray as the output tray if needed.
- (7) **Keyboard*1**
Use this as a substitute for the soft keyboard displayed on the touch panel. When not being used, it can be stored under the operation panel.
- (8) **Inner finisher*1**
This staples paper. A punch module can also be installed to punch holes in output paper. You can also perform stapling manually.
► [INNER FINISHER \(page 1-114\)](#)
- (9) **Toner cover (MX-5050V/MX-5070V/MX-6050V/MX-6070V)**
Open to replace a toner cartridge.
► [REPLACEMENT OF TONER CARTRIDGE \(page 1-157\)](#)
- (10) **Front cover (MX-5050V/MX-5070V/MX-6050V/MX-6070V)**
Open to switch the main power switch to "On" or "Off".
► [TURNING ON THE POWER \(page 1-10\)](#)
- (11) **Front cover (MX-2630N/MX-3050V/MX-3060V/MX-3070V/MX-3550V/MX-3560V/MX-3570V/MX-4050V/MX-4060V/MX-4070V)**
Open this cover to switch the main power switch to "On" or "Off" to replace a toner cartridge.
► [TURNING ON THE POWER \(page 1-10\)](#)
► [REPLACEMENT OF TONER CARTRIDGE \(page 1-157\)](#)

*1 Peripheral device.
Equipped standard or not available in some countries and regions. Not available on some models. Contact your dealer or nearest authorised service representative.

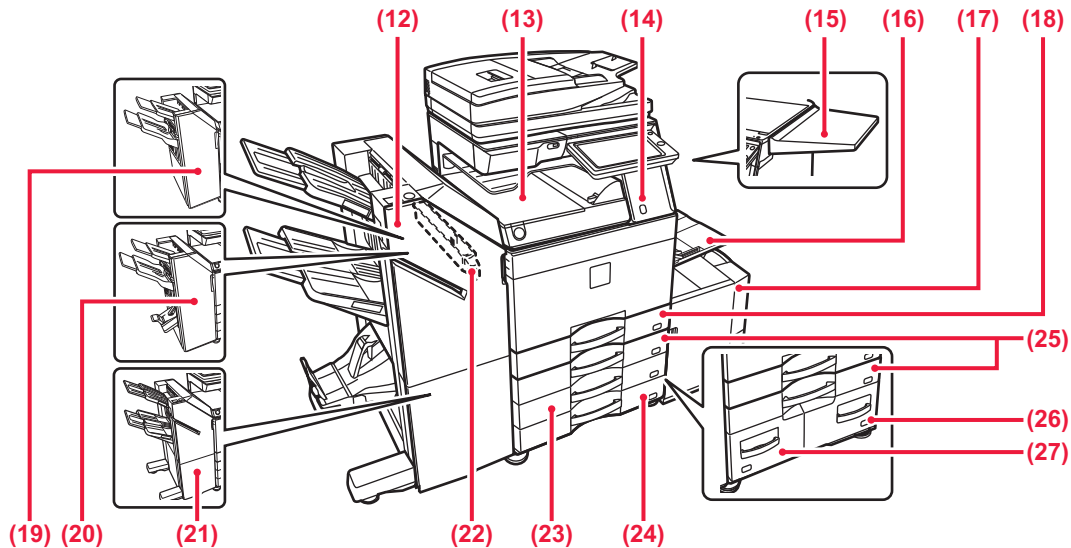
**(12) Saddle Stitch Finisher (large stacker)*1**

This staples and folds paper. A punch module can also be installed to punch holes in output paper. You can also perform stapling manually.

► [SADDLE STITCH FINISHER \(LARGE STACKER\) \(page 1-129\)](#)

(13) Paper pass unit*1

Relay between the machine and the finisher, finisher (large stacker), saddle stitch finisher or saddle stitch finisher (large stacker).

(14) Motion sensor*2

This sensor detects the presence of a person that approaches the machine, and automatically wakes the machine from sleep mode (Motion Sensor Mode Only).

(15) Utility table*1

You can use this as a work platform, or temporarily place originals or a mobile device.

- ! Do not place anything that weighs more than 5kg or otherwise apply a load.
- ! Do not place a container that contains water or other liquid. Risk of fire and electrical shock if the liquid spills and enters the machine.
- ! Working on the table while the machine is in operation may cause poor image quality or other problems.

(16) Bypass tray

Use this tray to feed paper manually. When loading paper larger than A4R or 8-1/2" x 11"R, pull out the extension guide.

► [LOADING PAPER INTO THE BYPASS TRAY \(page 1-78\)](#)

(17) Tray 5 (when a large capacity tray is installed)*1

Store paper in this tray.

► [LOADING PAPER IN THE LARGE-CAPACITY TRAY \(when a large capacity tray is installed\) \(page 1-76\)](#)

(18) Tray 1

Store paper in this tray.

► [TRAY 1 - 4 \(when a low stand/550 sheet paper drawer or stand/550/2x550/3x550/ 550&2100 sheet paper drawer is installed\) \(page 1-71\)](#)

(19) Finisher*1

This staples paper. A punch module can also be installed to punch holes in output paper.

► [FINISHER \(page 1-118\)](#)

(20) Saddle Stitch Finisher*1

This staples and folds paper. A punch module can also be installed to punch holes in output paper.

► [SADDLE STITCH FINISHER \(page 1-125\)](#)

(21) Finisher (large stacker)*1

This staples paper. A punch module can also be installed to punch holes in output paper. You can also perform stapling manually.

► [FINISHER \(LARGE STACKER\) \(page 1-121\)](#)

(22) Punch module*1

This is used to punch holes in output. Requires an inner finisher, finisher (large stacker), saddle stitch finisher or saddle stitch finisher (large stacker).

(23) Tray 3 (when a stand/2x550/3x550 sheet paper drawer is installed)*1

Store paper in this tray.

► [TRAY 1 - 4 \(when a low stand/550 sheet paper drawer or stand/550/2x550/3x550/ 550&2100 sheet paper drawer is installed\) \(page 1-71\)](#)

(24) Tray 4 (when a stand/3x550 sheet paper drawer is installed)*1

Store paper in this tray.

► [TRAY 1 - 4 \(when a low stand/550 sheet paper drawer or stand/550/2x550/3x550/ 550&2100 sheet paper drawer is installed\) \(page 1-71\)](#)

(25) Tray 2 (when a low stand/550 sheet paper drawer or stand/550/2x550/3x550/550&2100 sheet paper drawer is installed)*1

Store paper in this tray.

► [TRAY 1 - 4 \(when a low stand/550 sheet paper drawer or stand/550/2x550/3x550/ 550&2100 sheet paper drawer is installed\) \(page 1-71\)](#)

(26) Tray 4 (when a stand/550&2100 sheet paper drawer is installed)*1

Store paper in this tray.

► [TRAY 3 - 4 \(when a stand/550&2100 sheet paper drawer is installed\) \(page 1-74\)](#)

(27) Tray 3 (when a stand/550&2100 sheet paper drawer is installed)*1

Store paper in this tray.

► [TRAY 3 - 4 \(when a stand/550&2100 sheet paper drawer is installed\) \(page 1-74\)](#)

*1 Peripheral device.

Equipped standard or not available in some countries and regions. Not available on some models. Contact your dealer or nearest authorised service representative.

*2 Can only be used on the MX-3060V/MX-3070V/MX-3560V/MX-3570V/MX-4060V/MX-4070V/MX-5070V/MX-6070V.



INTERIOR

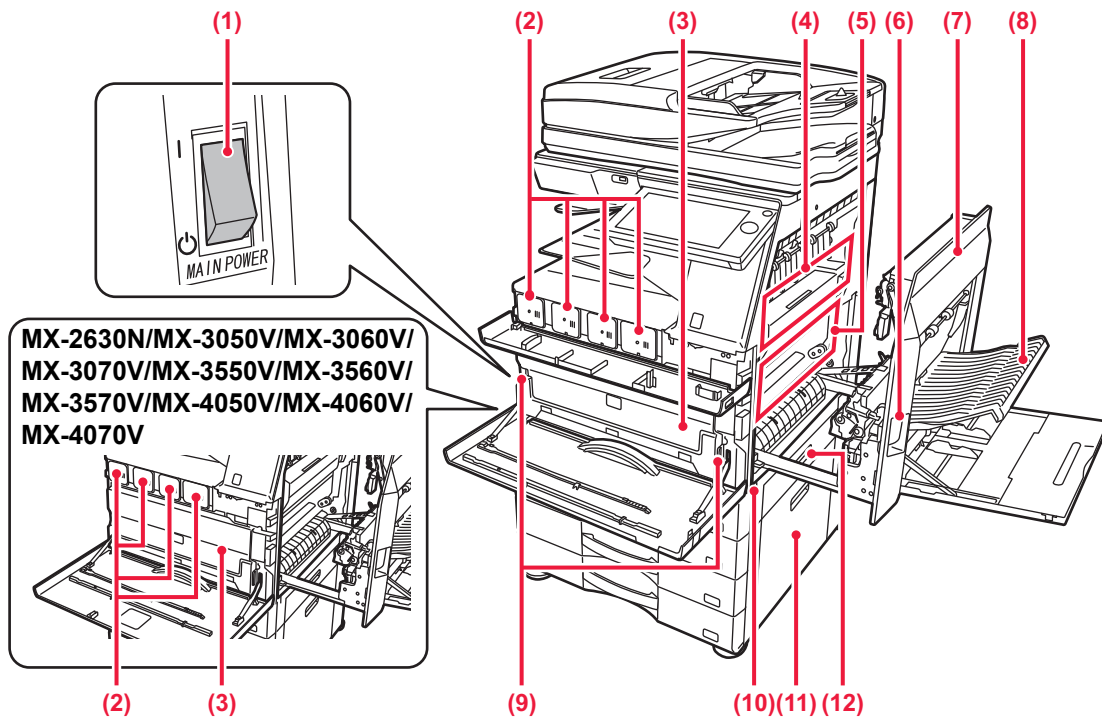

MX-2630N/MX-3050V/MX-3060V/
MX-3070V/MX-3550V/MX-3560V/
MX-3570V/MX-4050V/MX-4060V/
MX-4070V

(1) The main power switch

Use this switch to turn on the power for the machine. When using the fax or Internet fax functions, always keep this switch in the "I" position.

► [TURNING ON THE POWER \(page 1-10\)](#)

(2) Toner cartridge

This cartridge contains toner. When the toner in a cartridge runs out, replace with new one.

► [REPLACEMENT OF TONER CARTRIDGE \(page 1-157\)](#)

(3) Waste toner box

This container collects excess toner that remains after printing.

► [REPLACING THE WASTE TONER BOX \(page 1-161\)](#)

 A service technician collects replaced waste toner box.

(4) Fusing unit

Heat is applied here to fuse the transferred image onto the paper.

 The fusing unit is hot. Take care not to burn yourself when removing a misfeed.

(5) Transfer belt

During full colour printing, the toner images of the four colours on the photoconductive drums are combined together on the transfer belt. During black and white printing, only the black toner image is transferred onto the transfer belt.

 Do not touch or damage the transfer belt. This may cause a defective image.

(6) Right side cover release lever

To remove a paper misfeed, pull and hold this lever up to open the right side cover.

(7) Right side cover

Open this cover to remove a paper misfeed.

(8) Paper reversing section cover

This unit is used for reversing paper when 2-sided printing is performed. Open this cover to remove a paper misfeed.

(9) Waste toner box release button

Press this button when you need to release the waste toner box lock to replace the waste toner box or clean the laser unit.

► [CLEANING THE LASER UNIT \(page 1-153\)](#)

► [REPLACING THE WASTE TONER BOX \(page 1-161\)](#)

(10) Handle

Pull this out and grasp it when moving the machine.

(11) A low stand/550 sheet paper drawer or stand/550/2x550/3x550/550&2100 sheet paper drawer right-side cover
Open this to remove a paper misfeed in tray 2, 3 and 4.

(12) Paper tray right side cover

Open this to remove a paper misfeed in tray 1.



AUTOMATIC DOCUMENT FEEDER AND DOCUMENT GLASS

MX-2630N/MX-3050V/MX-3060V/MX-3550V/MX-3560V/MX-4050V/MX-4060V/
MX-5050V/MX-6050V

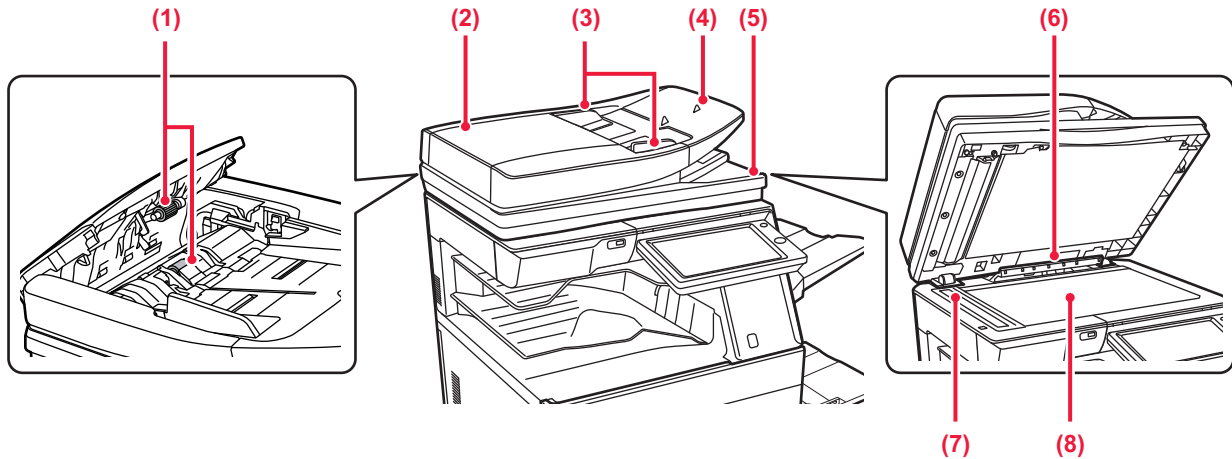

MX-3070V/MX-3570V/MX-4070V/MX-5070V/MX-6070V

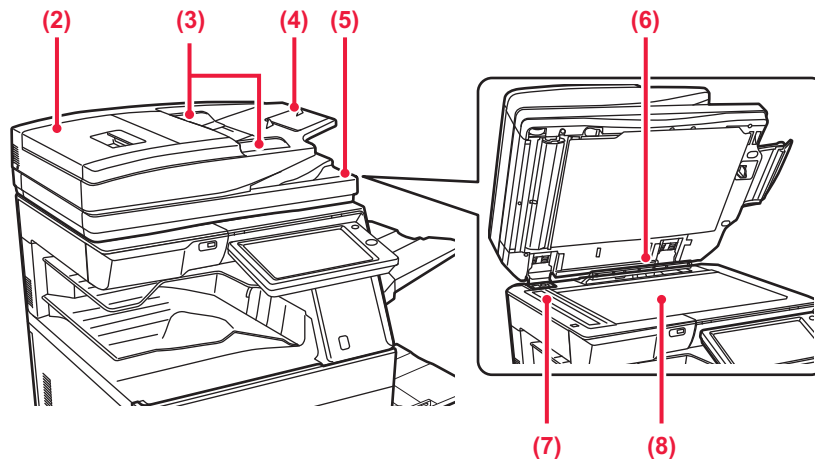

- | | |
|--|--|
| <p>(1) Paper feed roller
This roller rotates to automatically feed the original.</p> <p>(2) Document feeding cover
Open this cover to remove an original misfeed.
On the MX-2630N/MX-3050V/MX-3060V/MX-3550V/
MX-3560V/MX-4050V/MX-4060V/MX-5050V/MX-6050V,
this cover is also opened to clean the paper feed roller.
► CLEANING THE PAPER FEED ROLLER
(MX-2630N/MX-3050V/MX-3060V/MX-3550V/MX-3560
V/MX-4050V/MX-4060V/MX-5050V/MX-6050V only)
(page 1-156)</p> <p>(3) Original guides
These guides help ensure that the original is scanned
correctly.
Adjust the guides to the width of the original.</p> <p>(4) Document feeder tray
Place the original.
Place the original with the print side facing up.
► AUTOMATIC DOCUMENT FEEDER (page 1-84)</p> | <p>(5) Original exit tray
The original is discharged to this tray after scanning.</p> <p>(6) Original size detector
This unit detects the size of an original placed on the
document glass.
► DOCUMENT GLASS (page 1-86)</p> <p>(7) Scanning area
Originals placed in the automatic document feeder are
scanned here.
► CLEANING THE DOCUMENT GLASS AND
AUTOMATIC DOCUMENT FEEDER (page 1-145)</p> <p>(8) Document glass
If you want to scan books or other thick originals that
cannot be fed through the automatic document feeder,
place them on this glass.
► DOCUMENT GLASS (page 1-86)</p> |
|--|--|



SIDE AND BACK

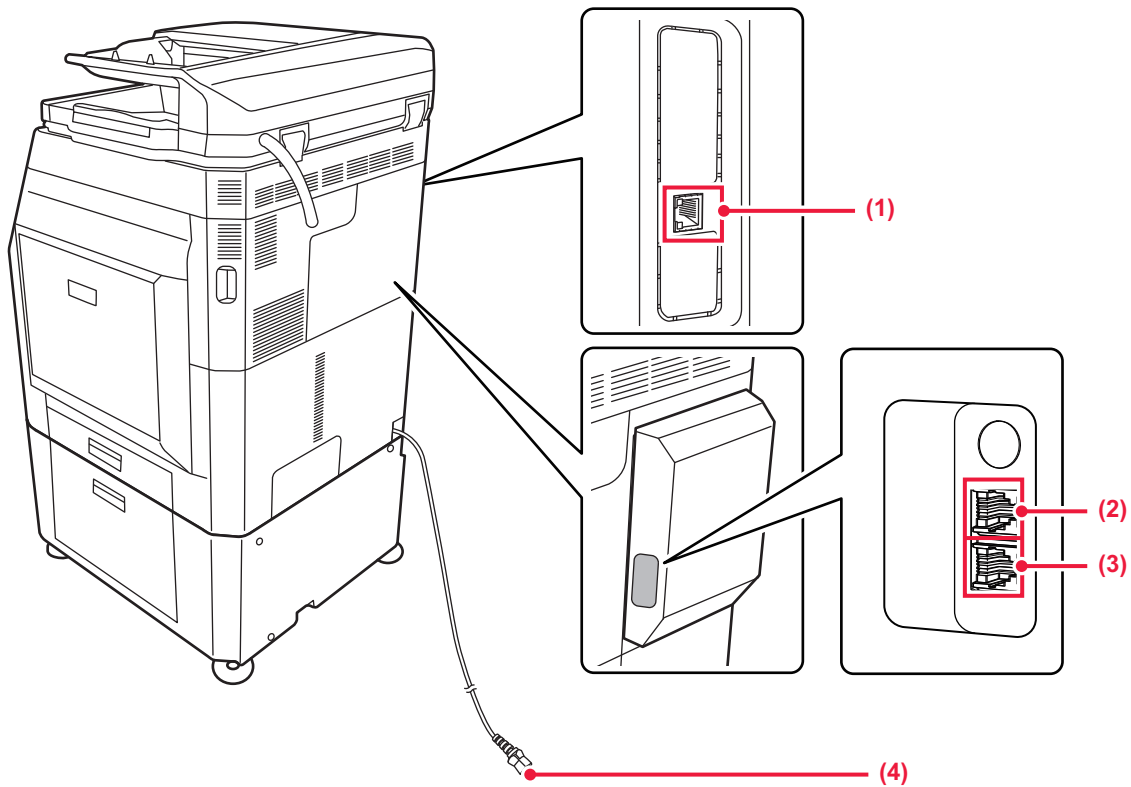

(1) LAN connector

Connect the LAN cable to this connector when the machine is used on a network.
Use a shielded LAN cable.

(2) Extension phone socket (TEL)*

When the fax function of the machine is used, an extension phone can be connected to this socket.

(3) Telephone line socket (LINE)*

When the fax function of the machine is used, the telephone line is connected to this socket.

(4) Power plug

* Optional



OPERATION PANEL

This section describes the names and functions of the respective parts of the operation panel.

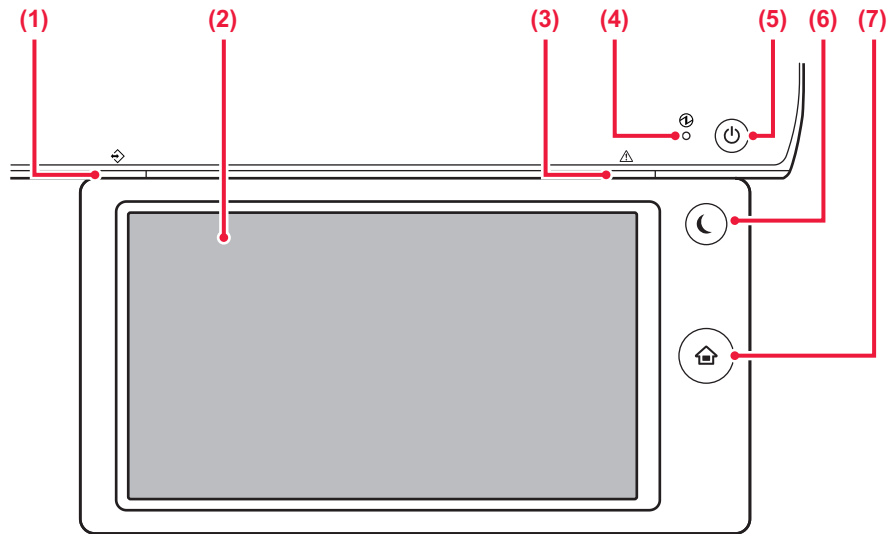

- (1) **Data notification indicator**
The indicator lights solidly or blinks to indicate the status of a job.
When the Job separator or Exit tray unit (right tray) is used for output, this blinks until the output is removed.
► [DATA NOTIFICATION INDICATOR AND ERROR INDICATOR \(page 1-9\)](#)
- (2) **Touch panel**
Messages and keys appear on the touch panel display.
Operate the machine by directly tapping the displayed keys.
► [TOUCH TYPES \(page 1-11\)](#)
- (3) **Error indicator**
Lights solidly or blinks to indicate the status of the error.
► [DATA NOTIFICATION INDICATOR AND ERROR INDICATOR \(page 1-9\)](#)
- (4) **Main power indicator**
This lamp lights up when the machine's main power switch is in the "I" position.
Blinks green during the time that the [Power] button does not operate immediately after the main power switch is switched on.
► [TURNING ON THE POWER \(page 1-10\)](#)
- (5) **[Power] button**
Use this button to turn the machine's power on and off.
► [TURNING ON THE POWER \(page 1-10\)](#)
- (6) **[Power Save] button/indicator**
Use this button to set the machine to Sleep mode for energy saving.
[Power Save] button blinks when the machine is in Sleep Mode.
► [AUTO POWER SHUT-OFF MODE \(page 1-27\)](#)
- (7) **[Home Screen] key**
Use this button to display the home screen.
► [HOME SCREEN \(page 1-14\)](#)



[Home Screen] key

Use your finger to touch the [Home Screen] key.
If you use a pen or other tool to touch the key, it may not operate properly.
Risk of malfunctioning if you use with jewelry or other accessories.



You can change the angle of the touch panel.

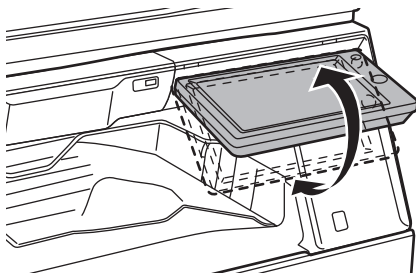



DATA NOTIFICATION INDICATOR AND ERROR INDICATOR

The data notification indicator and the error indicator lights solidly or blinks to indicate the status of the machine.

	Error indicator (red)	Data notification indicator (green)		
		Pattern 1	Pattern 2	Pattern 3
Solidly	Errors that do not stop machine operation, such as almost out of toner.	Job in progress, such as paper feeding or output.	Ready state or other state where jobs can be accepted.	An original has been placed in the document feeder
Blinks	Errors that stop machine operation, such as misfeeds and out of toner.	A fax is being received When the job separator (upper tray) or exit tray unit (right tray) is used for output, this blinks until the output is removed.		
On/Blinking Priority	Blinking Priority	Blinking Priority	Blinking Priority	On Priority



- **To set the status indicated by the data notification indicator**

In "Settings (administrator)", select [System Settings] → [Common Settings] → [Device Control] → [Data Indicator Setting].

- **To set the error indication**

Set in "Settings (administrator)" - [System Settings] - [Common Settings] - [Device Control] - [Error Light Setting].



TURNING ON THE POWER

This section describes how to turn on/off the machine's power and how to restart the machine.

Operate two power switches: the main power switch inside the front cover, located in the lower left corner, and the [Power] button on the operation panel.



When a finisher (large stacker) or saddle stitch finisher (large stacker) is installed on the MX-5050V/MX-5070V/MX-6050V/MX-6070V, open the front cover on the finisher (large stacker), or the front upper cover on the saddle stitch finisher (large stacker), before opening the front cover of the machine.

Turning on the power

- Turn the main power switch to the " | " position.
- When the main power indicator lights in green, press the [Power] button.

Turning off the power

Turn off the power by pressing the [Power] button, then turn the main power switch to the " ⏻ " position.

Restart the machine

Turn off the power by pressing the [Power] button and then press it again to turn on the power.

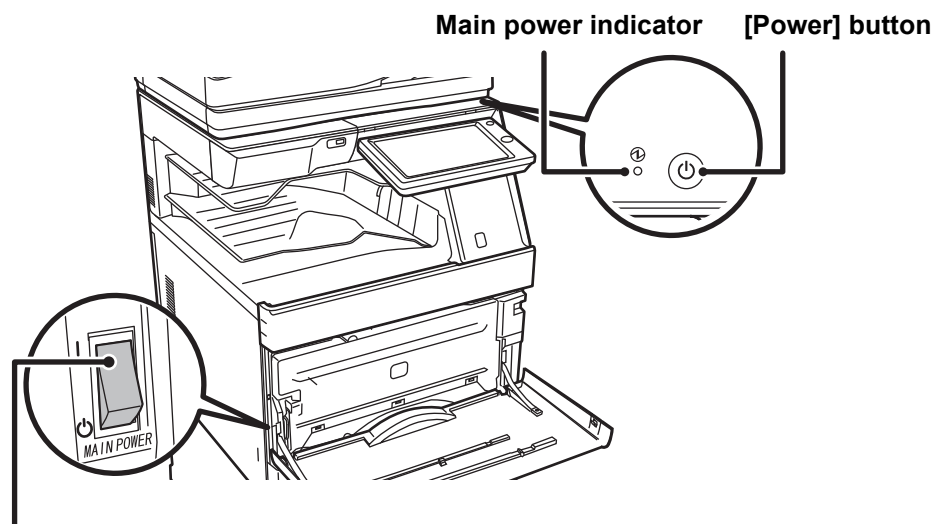

The main power switch



- When turning off the main power switch, press the [Power] button on the operation panel and then turn the main power switch to the " ⏻ " position.
In a sudden case of main power outage, turn the power for the machine back on and then turn it off in the correct order. If the machine is left for a long time with the main power having been turned off prior to the [Power] button being turned off, abnormal noises, degraded image quality or other problems may result.
- Turn off both the [Power] button and the main power switch and unplug the power cord if you suspect a machine failure, if there is a bad thunderstorm nearby, or when you are moving the machine.



- When using the fax or Internet fax function, always keep the main power switch in the " | " position.
- In order for some settings to take effect, the machine must be restarted. In some states of the machine, restarting with the [Power] button may not make the settings take effect. In this case, turn off the main power switch and then turn it on again.



TOUCH PANEL

TOUCH TYPES

In addition to tapping, equivalent to conventional touching, the touch panel of the machine can be operated by long touching, flicking and sliding.

Operation types

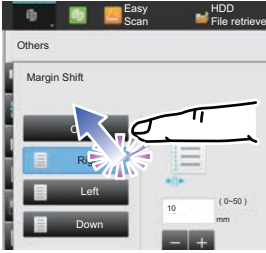
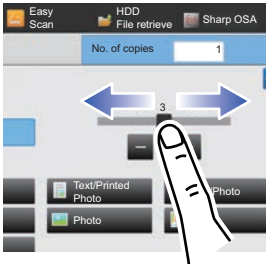
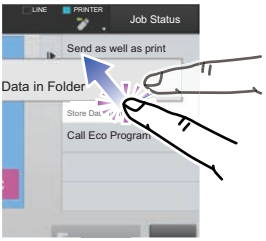
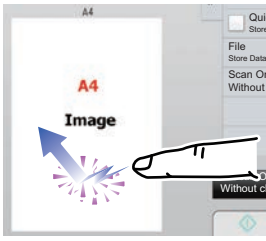
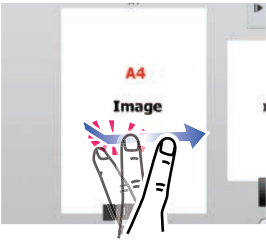
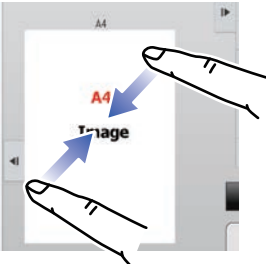
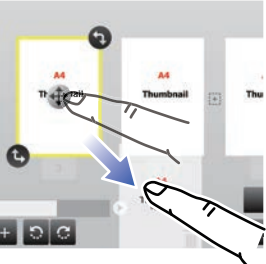
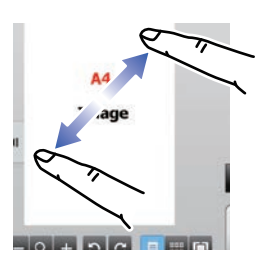
	<p>Tapping Touch the panel with your finger and then lift it quickly. Use this method to select a key, tab or check box.</p>		<p>Sliding Slide the scroll bar (with your finger touching the panel) to scroll up and down a list with a large number of items.</p>
	<p>Long touching Touch the panel with your finger and hold it for a while. Keep holding (long touching) it on the action panel or characters in the text box to display characters in a balloon.</p>		<p>Double tapping Touch the screen twice. Use this operation to enlarge the image in the preview.</p>
	<p>Flicking Flick the panel to scroll a preview image quickly.</p>		<p>Pinch Touch the screen with two fingers and move them toward each other. This is used to reduce the browser and preview display.</p>
	<p>Dragging Drag (slide your finger touching the panel in a random direction) to replace a page in the original during preview.</p>		<p>Spread Touch the screen with two fingers and move them away from each other. This is used to enlarge the browser and preview display.</p>



Operation on respective screens

Key (tapping)

- A. Tap to select an item. The selected key turns into a different colour.
- B. Tap numeric keys to enter numbers.
- C. Tap to increase or decrease the value. Long touching causes the value to be increased or decreased until you stop touching.
- D. Tap to enter a checkmark and enable the setting.
- E. Tap here to close the screen.

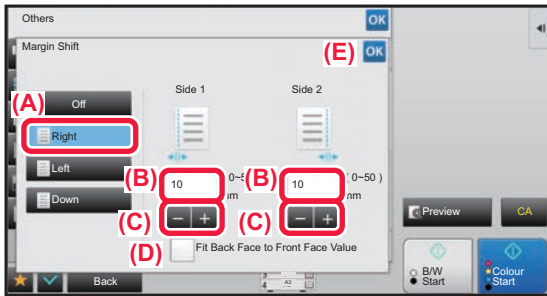

List (tapping, sliding and flicking)

- A. Tap to select an item. The selected item turns into a different colour.
- B. Slide the bar up and down.
It appears when the item does not fit in the screen.
- C. Flick the key upwards or downwards. The item scrolls up or down.

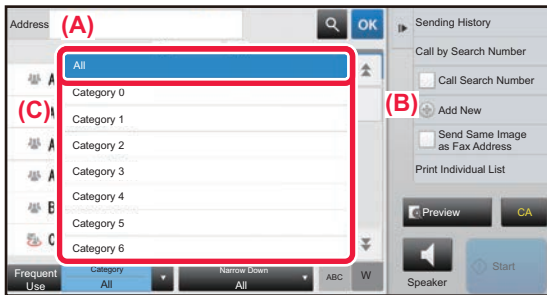

Slider (sliding)

- A. Slide the knob from side to side.

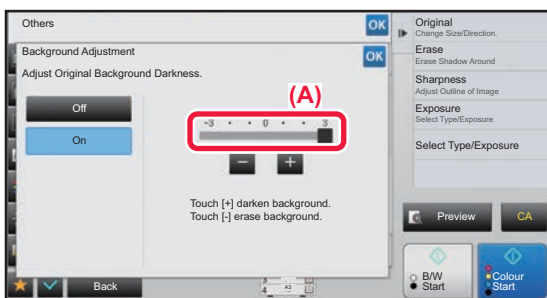



Tab (tapping)

A. Tap a tab to switch what is displayed.

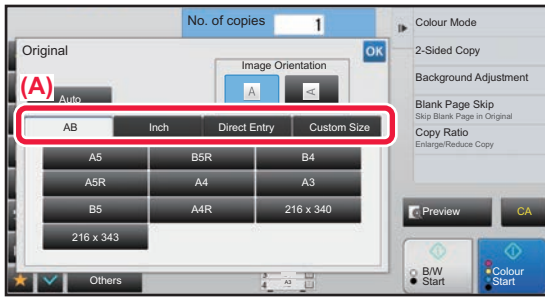

Preview screen (Double tapping/ Pinch/ Spread)

A. When a preview screen is "pinched", the screen image is reduced. When "spread", the image is enlarged. When "Double tapping", the image is also enlarged.

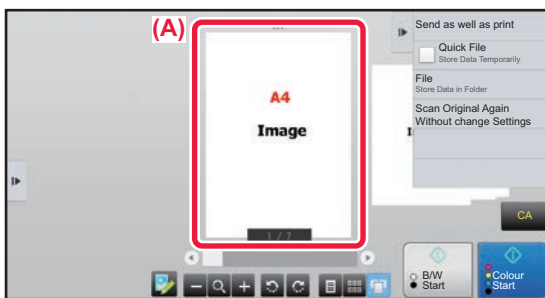



HOME SCREEN

Pressing the [Home Screen] key on the operation panel displays the home screen on the touch panel. The home screen displays the keys for selecting modes or functions.

Tap a mode to change to that mode.
▶ [Changing mode from the mode display \(page 1-16\)](#)

Select shortcut keys for modes or functions.
▶ [Changing mode from the Home screen \(page 1-16\)](#)

Use these keys to select functions that make the machine easier to use.

Displays the machine's status other than the job using icons.
▶ [Icon indicating the status of the machine \(page 1-15\)](#)

Displays the time.

Displays the job in progress or waiting with text or icon.

Select functions that can be utilized in respective modes.
Tap the tab, and the list of function keys is displayed.
▶ [ACTION PANEL \(page 1-24\)](#)

Switch the pages for displaying shortcut keys.

For procedures for adding and deleting shortcut keys, see "U/I Customize Guide".



- **To set the home screen for each "Favourite Operation Group List":**
In "Settings (Web version)", select [User Control] → [Favourite Operation Group List] → [Home Screen List]. Perform this setting when user authentication is used.
- **To display the External Service Connect shortcut keys:**
You can add shortcut keys for the External Service Connect functions (Google Drive, OneDrive, SharePoint Online, Gmail, Exchange (E-Mail)) to the home screen.
These functions can be enabled in the system settings. When a function is enabled in the system settings, you can add a shortcut key for that function to the home screen.
External Service Connect settings are configured in "Settings (administrator)" - [System Settings] → [Network Settings] → [External Print Services Settings].



Icon indicating the status of the machine

Icon	Machine status	Icon	Machine status
	Printer data is being processed.		A USB device is installed.
	Printer data is being printed.		The field support system is enabled.
	Send data exists.		Single-byte alphanumeric character entry
	Forward error data exists.		A data security kit is installed.
	Received data exists.		Connecting to the access point (Level 4)
	Received confidential fax data exists.		Connecting to the access point (Level 3)
	Received data is held.		Connecting to the access point (Level 2)
	Received preview data exists.		Connecting to the access point (Level 1)
	OSA communication is in progress.		Not connected to the access point
	Enlarge display mode is enabled.		Bad connection of the wireless LAN device in the machine*
	Eco mode is enabled.		Waiting for the access point
	A maintenance notification is issued.		A LAN cable is not connected.
	Remote operation is in progress.		

* Contact your dealer or nearest authorised service representative.



CHANGING MODES

Changing mode from the Home screen

Press the [Home Screen] key.

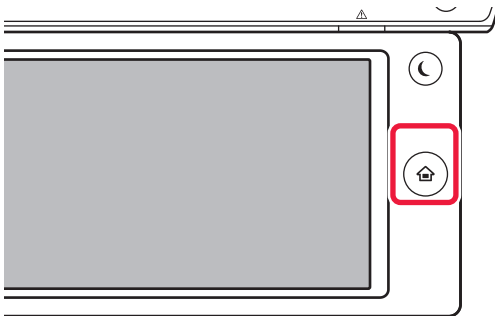

Tap the mode icon.

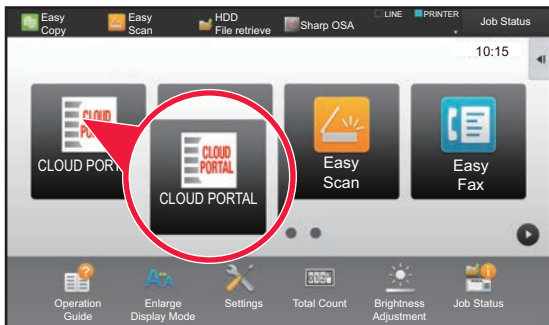

Changing mode from the mode display

Tap on the mode display.

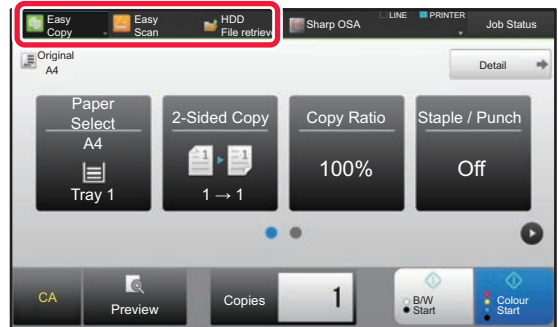

Tap the key that shows ▼.

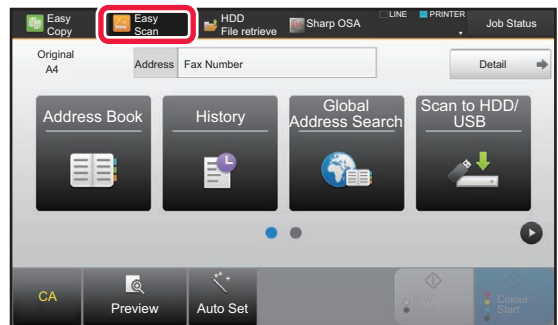

Tap for any mode desired.

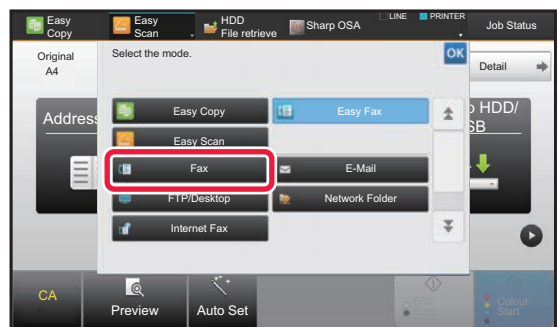

For procedures for editing the home screen, see "U/I Customize Guide".



PREVIEW SCREEN

In the preview screen, you can view output images or images stored in the machine using the touch panel.

In Easy mode

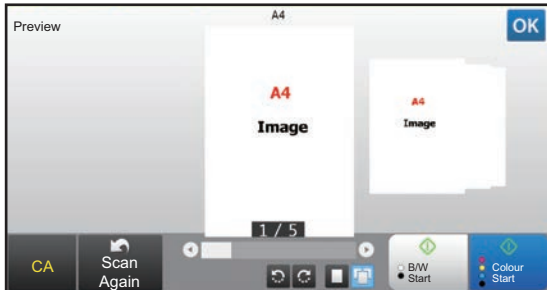

In Normal mode

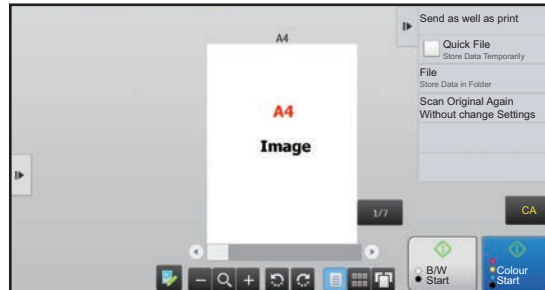

Keys used in the preview screen

	This changes the mode to edit mode. Pages of the original can be changed, rotated, or deleted.		This rotates the preview image of whole page in the arrow's direction. The printing result is not rotated.
	This reduces the image.		This displays preview images of respective pages.
	This displays the scroll bar for enlargement/reduction operations. Moving the slider to the left reduces the image, and moving the slider to the right enlarges the image.		This displays thumbnails of preview images.
	This enlarges the image.		This displays pages in a 3D view.

* Can also be used in Easy mode.



- The display position of an image can be moved by dragging it while it is enlarged.
- To enlarge an image, double-tap it when the preview image is displayed by page.



Deleting a page

1

In the preview screen, tap  to switch to edit mode.

2

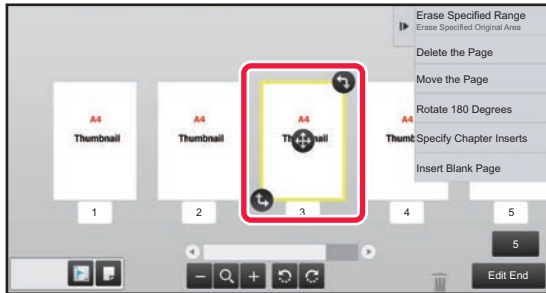

Tap the page you want to delete, and tap .



- You can also delete the page by tapping [Delete the Page] on the action panel.
- You can also delete the page by dragging a page to .

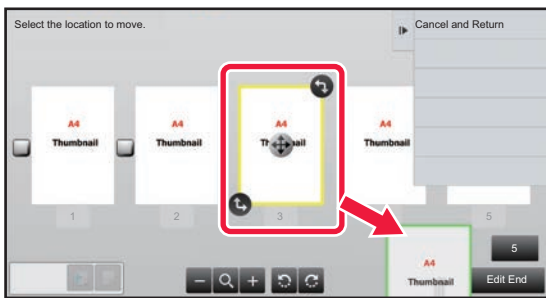

- To undo the deletion, tap . To redo the deletion, tap .

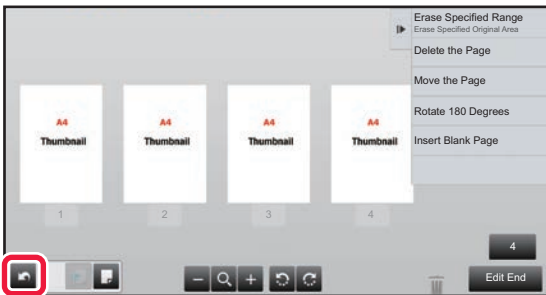

3

Tap the [Edit End] key.





Moving a page

1

In the preview screen, tap  to switch to edit mode.

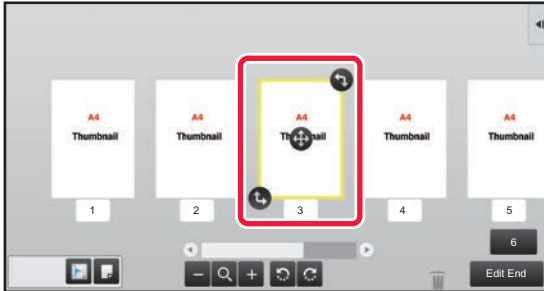
2



Tap the page you want to move, and drag  to move the page.



You can also move the page by tapping [Move the Page] on the action panel and then tap  of the destination.

3

Tap the [Edit End] key.



Rotating a page

1

In the preview screen, tap  to switch to edit mode.

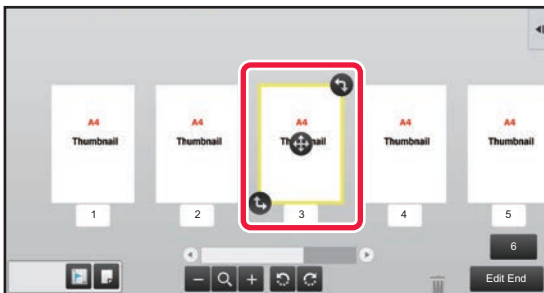
2



Tap the page you want to rotate, and drag  or  to rotate the page.



You can also rotate the page by tapping [Rotate 180 Degrees] (Copy mode only) or [Rotate 90 Degrees] (Fax and scanner mode only) on the action panel.

3

Tap the [Edit End] key.



Setting chapter inserts

When N-Up or 2-Sided is specified, you can move a page marked with  to the first page.

1

In the preview screen, tap  to switch to edit mode.

2

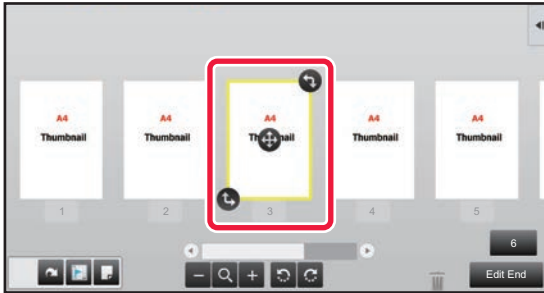

Tap the page you want to set chapter inserts.

3

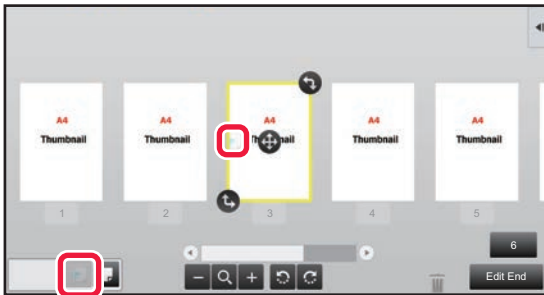

Tap .

 is displayed on the page.



• You can also set chapter inserts by tapping [Specify Chapter Inserts] on the action panel.

• **To cancel the Chapter Inserts setting:**

Tap  displayed on the page, or select the page and tap [Cancel Chapter Inserts of Selected Page.] on the action panel.

4

Tap the [Edit End] key.



Inserting a blank page

1

In the preview screen, tap  to switch to edit mode.

2

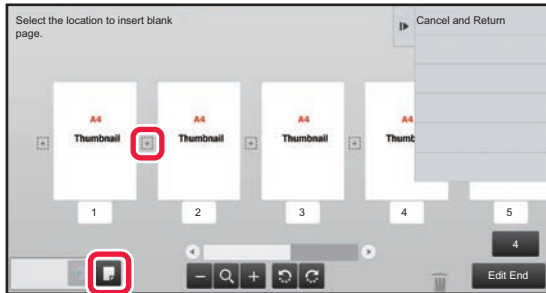

Tap , and tap  for the location into which you want to insert a blank page.



You can also insert a blank page by tapping [Insert Blank Page] on the action panel.

3

Tap the [Edit End] key.

Deleting part of the original image

1

In the preview screen, tap  to switch to edit mode.

2

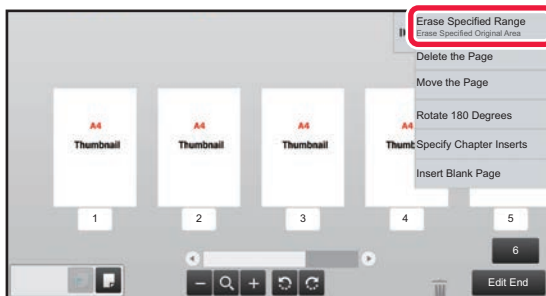

Tap [Erase Specified Range] on the action panel.



3

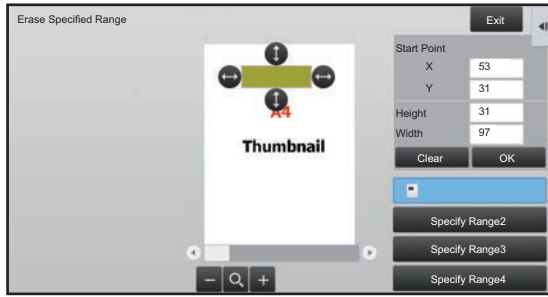

Follow the on-screen instructions to specify the erase range.

Specify the erase range and then tap the [OK] key.



To delete the image outside the selected range, tap [Reverse Erase Range] on the action panel.

4

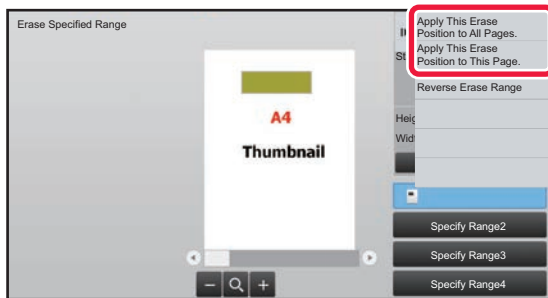

On the action panel, select [Apply This Erase Position to All Pages.] or [Apply This Erase Position to This Page.].

5

As necessary, repeat the steps to specify the erase range and the pages to which it is applied.

6



Tap the [Exit] key.

Changing the settings

Tapping the tab on the left of the screen allows you to change the colour mode and other settings. You cannot tap the keys for functions whose settings cannot be changed.

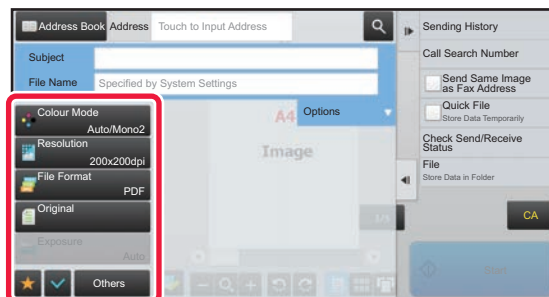



OPERATION OF FREQUENTLY USED KEYS

Numeric keys

Tap a number to enter it.

To clear the entered number, tap the [C] key.

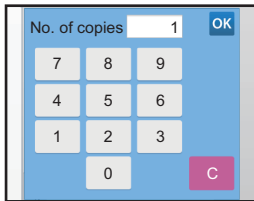

On the address screen, you can enter characters other than numbers, and a different key layout is provided. You can also move the cursor by using the [←] and [→] keys. Tap the [C] key to delete one character to the left of the cursor.

[Start] key ([B/W Start] key and [Colour Start] key)

Tap to perform a print or send job.



In copy mode, [B/W Start] and [Colour Start] keys are displayed.

[Cancel Copy] key, [Storing Cancelled] key, [Cancel Scan] key, [Sending Cancelled] key

Tap to stop copying, printing, or transmission.

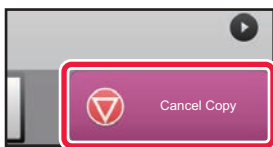

[CA] key



Tap to cancel all settings and restore the initial status in each mode.



ACTION PANEL

Recommended functions are displayed on the action panel when you configure functions in each mode. From the action panel, you can configure functions or combine the configured function with a function displayed on the action panel.

If the action panel does not appear, tap the action panel tab.

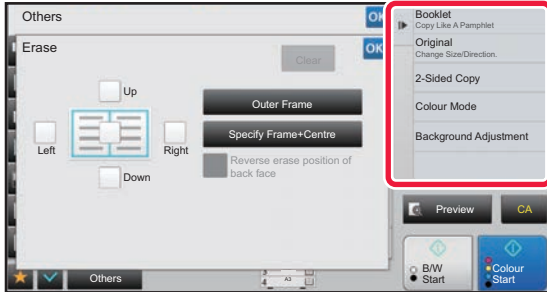

- The functions displayed on the action panel vary depending on the mode or the functions that have been configured.
- If too many functions have been configured to be displayed on the action panel, you can slide the panel vertically or tap and to view all.
- In enlarge display mode, part of the text on the action panel may not be displayed. To display the whole text, long-touch the partially hidden key or slide the tab of the action panel to the left.



To always display the action panel

In "Settings(administrator)", select [System Settings] → [Common Settings] → [Operation Settings] → [Condition Settings] → [Display Action Panel as default].

CONFIRMATION SCREEN FOR FAVOURITE MENUS AND SETTINGS

When you register frequently used functions you have configured for copying or image sending in favourite, you can quickly call them.



Favourite can be used in normal mode.

Registering a function in Favourite

1

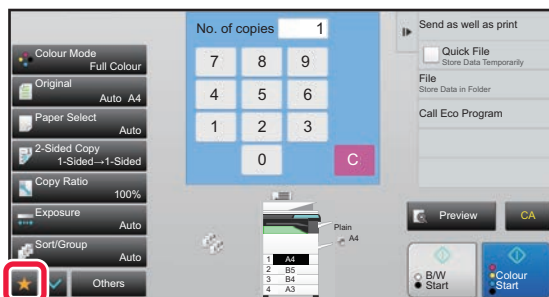

Tap .

2

Tap [Edit Favorite] on the action panel.



3

Tap the [Register Key] key.

Administrator rights are required.

4

Tap the key for the function you want to register.

Calling a function from Favourite

1

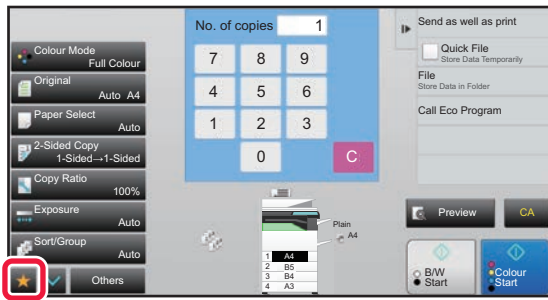

Tap .

2

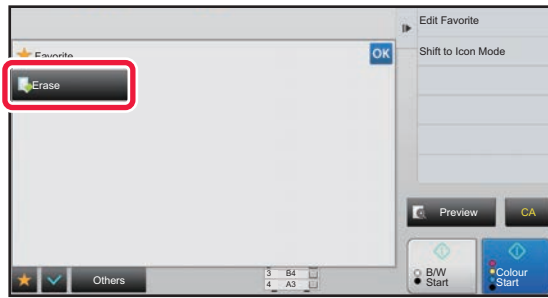

Tap the key for the function you want to call.



- Favourites can be registered or edited only by authenticated users and administrators.
- Unauthenticated users can call and use the favourites registered by administrators. Settings for calling Favourites and permitting/prohibiting editing can be configured in [User Control] → [Authority Group List] in "Settings (administrator)".
- To edit favourites, tap and then tap [Edit Favorite] on the action panel.

Confirmation Screen for Settings

You can display a list of configured functions and check them.

On the initial screen of each mode, tapping displays the setting confirmation screen.

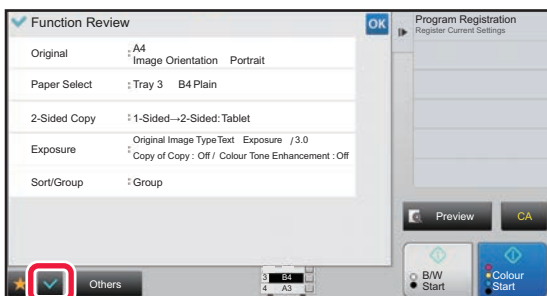



Eco

ECO FUNCTIONS OF THE MACHINE

These functions help save power consumption by managing operations of sections prone to high power consumption. The machine provides two power-saving modes.

Function	Description	Page
AUTO POWER SHUT-OFF MODE	If no operations take place, this mode will turn off the power to the operation panel and the fusing unit, and makes the machine wait in the lowest power consumption state. Although the power-saving rate is higher, the wakeup time is longer.	1-27
PREHEAT MODE	This mode lowers the temperature of the fusing unit and makes the machine wait in low power consumption state. Compared to Auto Power Shut-Off Timer, the power-saving rate is lower, but the wakeup time is shorter.	1-28

In addition to these two modes, using the following functions in conjunction helps reduce even more power consumption.

Function	Description	Page
ECO RECOMMENDATION FUNCTION DISPLAY	Shows recommended copy/print settings for copy, document filing reprint, and direct print.	1-28
AS SOON AS THE REMOTE JOB IS FINISHED, ENTER AUTO POWER SHUT OFF MODE	The machine returns from Auto Power Shut-Off and enters Auto Power Shut-Off mode as soon as printing is completed.	1-29
ECO SCAN	The machine is operated with the fusing unit turned off for non-printing operations (that do not use the fusing unit) such as fax and image transmission.	1-29
POWER ON/OFF SCHEDULE SETTING	Use this function to set the times for turning the power on and off to reduce power consumption.	1-30
SPECIFIC DATE OPERATION SETTINGS	When you must have the machine perform exceptionally many print jobs or other special operation on a certain day, you can specify the day as a "Specific Date" and define an energy saving pattern only for that day.	1-30
Toner Save Mode	This mode is used to reduce toner consumption.	7-168
MOTION SENSOR (MX-3060V/MX-3070V/MX-3560V/MX-3570V/MX-4060V/MX-4070V/MX-5070V/MX-6070V only)	This sensor detects the presence of a person that approaches the machine, and automatically wakes the machine from sleep mode (Motion Sensor Mode Only).	1-31
Sleep Mode Power Level	Select whether priority is given to power saving or wakeup time.	7-165

Mode Settings

The eco function settings are set in a batch. "Custom" and "Eco" are available. Setting values applied by each mode is as follows.

Function	Custom	Eco
Eco Scan	On (Sending Modes Only)	On (All Modes Except Copy)
Auto Power Shut-Off Timer	Fix transition time.: 11min. (for Europe) 1min. (Except for Europe)	Fix transition time.: 1min.



Function	Custom	Eco
As soon as the remote job is finished, enter Auto power shut off mode.	On	On
Preheat Mode Setting	1min.	1min.
Turn off Panel Display during pre-heat mode	On	On
Sleep Mode Power Level	Low Power	Low Power

Each Energy Save settings in System Setting is not applied when Eco mode is used.



To set mode settings

"Settings (administrator)" → select [System Settings] → [Energy Save] → [Eco Setting] → [Mode Setting].

AUTO POWER SHUT-OFF MODE

This mode turns off the power to the operation panel and the fusing unit, and makes the machine wait in the lowest power consumption state.

Auto Power Shut-Off Timer will activate when the set duration of time elapses in waiting status without executing a job. Compared to preheat mode, the power-saving rate is considerably higher but the wakeup time is longer.

The [Power Save] button blinks when the machine is in Auto Power Shut-Off Timer.

Auto Power Shut-Off Timer is also activated by pressing the [Power Save] button while the [Power Save] button is not lit. This mode is cleared when print data is being received, fax data is being output, or when the [Power Save] button is pressed while it is blinking.

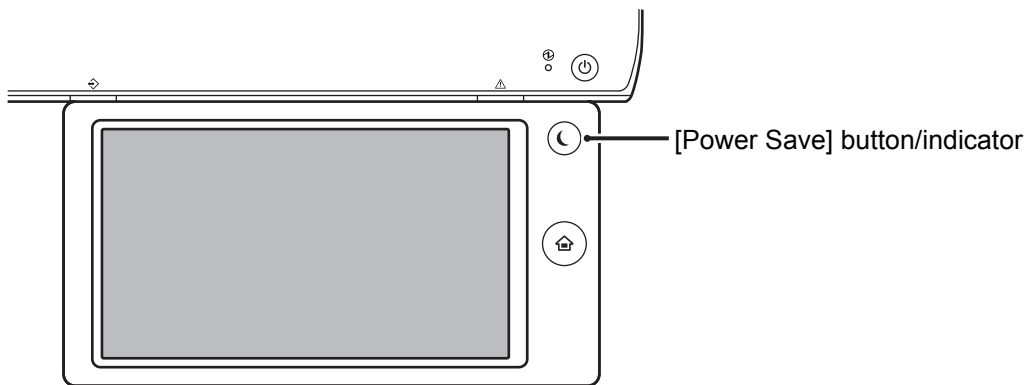

To set Auto Power Shut-Off Timer:

In "Settings (administrator)", select [System Settings] → [Energy Save] → [Eco Setting] → [Auto Power Shut-Off].

A message appears 15 seconds before Auto Power Shut-Off Mode is entered.

To close the message and continue normal operation, tap the [Continue] button.

The message appears again 15 seconds before the end of the extension of normal operation time.

If no action is taken within 15 seconds after the message appears, the machine enters auto power shutoff mode.



To set display of the message:

In "Settings (administrator)", select [System Settings] → [Energy Save] → [Eco Setting] → [Display Message When Extending Transition Time to Preheat/Auto Power Shut-Off Mode].



PREHEAT MODE

This mode lowers the temperature of the fusing unit and makes the machine wait in low power consumption state. Preheat mode will activate when the set duration of time elapses in waiting status without executing a job. Compared to Auto Power Shut-Off Mode, the amount of energy saved is less and the wakeup time is shorter. In the preheat mode, the [Home Screen] key is lit and the light goes off for the touch panel and the [Power Save] button. The touch panel is cleared when it is tapped or the [Home Screen] button is pressed.



To set preheat mode:

"Settings (administrator)" → select [System Settings] → [Energy Save] → [Eco Setting] → [Preheat Mode Setting].

A message appears 15 seconds before Preheat Mode is entered.

To close the message and continue normal operation, tap the [Continue] button.

If no action is taken within 15 seconds after the message appears, the machine enters preheat mode.



To set display of the message:

In "Settings (administrator)", select [System Settings] → [Energy Save] → [Eco Setting] → [Display Message When Extending Transition Time to Preheat/Auto Power Shut-Off Mode].

ECO RECOMMENDATION FUNCTION DISPLAY

Shows recommended copy/print settings for copy, document filing reprint, and direct print.

Copying

When you change to copy mode (normal mode), the settings recommended for copy mode appear.

Recommended settings: 2-Sided Copy, N-Up, B/W Copy and Image Orientation

Document filing print

When you tap the [Change Setting to Print] in the action panel on the file list screen of document filing, the settings recommended for this mode appear.

Recommended settings: 2-Sided Print, N-Up, and Print B/W.

Direct print

When you tap the [Change Setting to Print] in the action panel on the file list screen of direct print, the settings recommended for this mode appear.

Recommended settings: 2-Sided Print, N-Up and Print B/W.



AS SOON AS THE REMOTE JOB IS FINISHED, ENTER AUTO POWER SHUT OFF MODE

Printing or outputting received fax data in Auto Power Shut-Off Timer turns on the power, and then the machine returns to Auto Power Shut-Off Mode immediately after completing the print job.

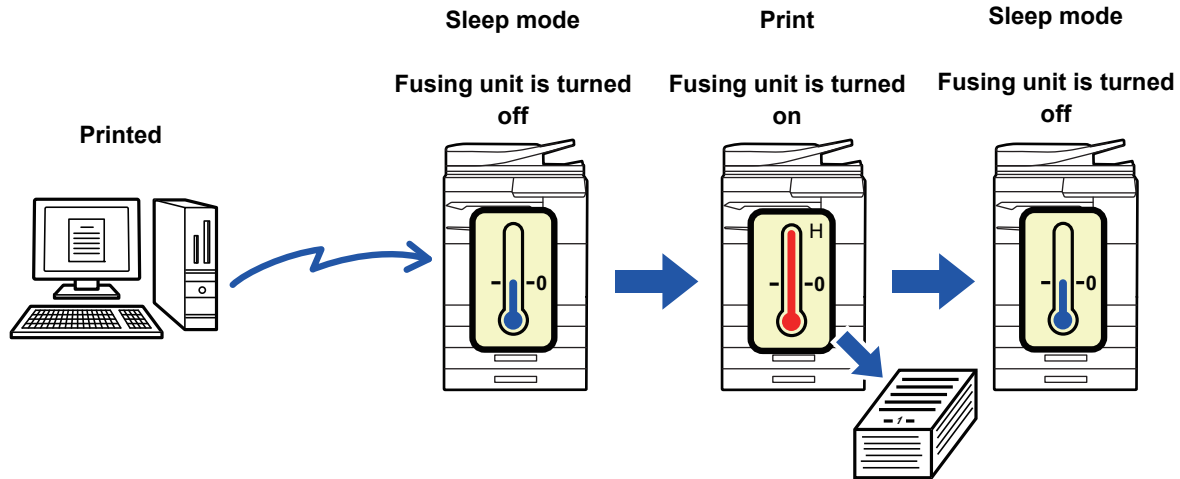

To set "As soon as the remote job is finished, enter Auto power shut off mode.":

In "Settings (administrator)", select [System Settings] → [Energy Save] → [Eco Setting] → [As soon as the remote job is finished, enter Auto power shut off mode.]

ECO SCAN

Non-print jobs such as sending a scanned original are performed with the fusing unit turned off.

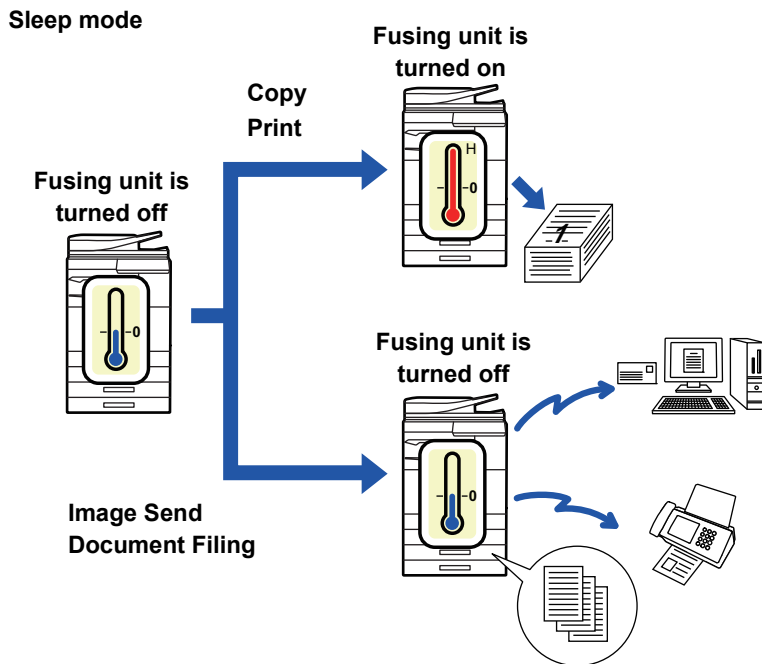

To set Eco scan:

"Settings (administrator)" → select [System Settings] → [Energy Save] → [Eco Setting] → [Eco Scan Setting] .



POWER ON/OFF SCHEDULE SETTING

Use this function to set the times for turning the power on and off for the machine to reduce power consumption.

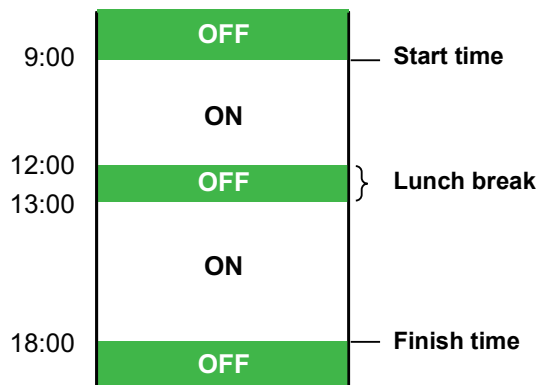

Setting Power ON/OFF Scheduling Function

In "Settings", select [System Settings] → [Energy Save] → [Power ON/OFF Schedule Setting].

SPECIFIC DATE OPERATION SETTINGS

When you must have the machine perform exceptionally many print jobs or other special operation on a certain day, you can specify the day as a "Specific Date" and define an energy saving pattern only for that day.



To specify operation for the specific date:

"Settings (administrator)" select [System Settings] → [Energy Save] → [Specific Date Operation Settings].



MOTION SENSOR (MX-3060V/MX-3070V/MX-3560V/ MX-3570V/MX-4060V/MX-4070V/MX-5070V/MX-6070V only)

This sensor detects the presence of a person that approaches the machine, and automatically wakes the machine from sleep mode (Motion Sensor Mode Only).

Three settings are available for the detection range (I / II / III).

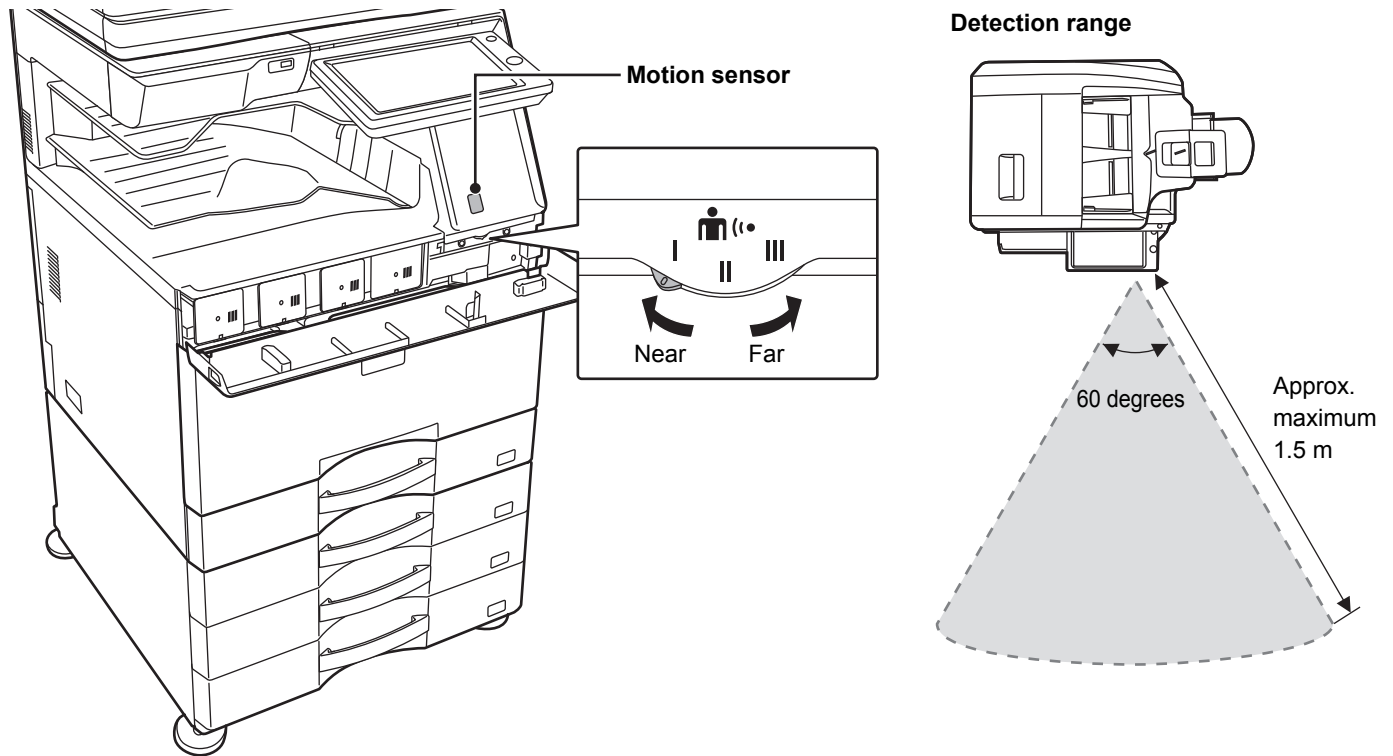

- The motion sensor detects the movement of sources of heat.
- The detection range may vary depending on the installation site and environment (ambient temperature, etc.).



The motion sensor may not operate correctly in the conditions below.

- An object is in front of the motion sensor
- There are scratches or dirt on the motion sensor cover
- The motion sensor is directly exposed to sunlight or air flow
- The motion sensor is damaged
- There is a source of heat such as a heater nearby
- An object is moving in the detection range



To enable the motion sensor

"Settings (administrator)" select [System Settings] → [Energy Save] → [Eco Setting] → [Sleep Mode Power Level].



USER AUTHENTICATION

User authentication restricts the use of the machine to users that have been registered. The functions that each user is allowed to use can be specified, allowing the machine to be customized to meet the needs of your workplace. When the administrator of the machine has enabled user authentication, each user must log in to use the machine. There are different types of user authentication, and each type has a different login method.

For more information, see the explanations of the login methods.

- ▶ [AUTHENTICATION BY USER NUMBER \(page 1-32\)](#)
- ▶ [AUTHENTICATION BY LOGIN NAME/PASSWORD \(page 1-34\)](#)

AUTHENTICATION BY USER NUMBER

The following procedure is used to log in using a user number received from the administrator of the machine. When starting the machine, the login screen appears.

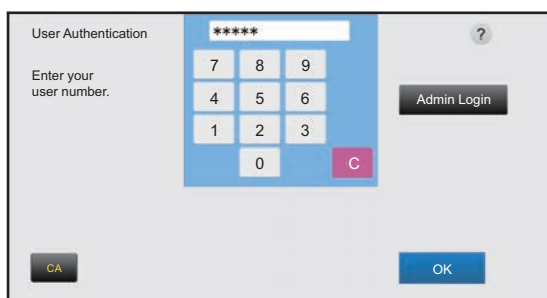

When controlled by user number



If "A Warning when Login Fails" is enabled in the system settings, the operation panel will be locked for five minutes if an incorrect user number is entered three times in a row. Contact the machine administrator to check the user number assigned for you.

1

Enter your user number (5 to 8 digits) using the numeric keys.

Each entered digit will be displayed as " * ".



2

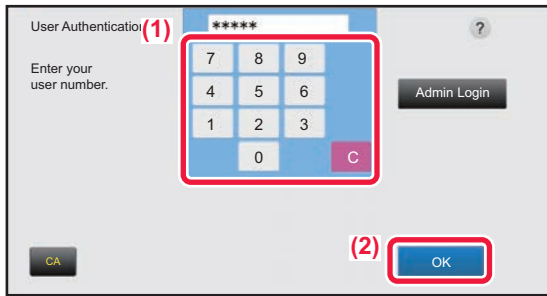

Tap the [OK] key.

If the entered user number is authenticated, the number of remaining pages that the user can copy or scan is displayed. When a limitation is set for the number of pages that a user can use, the use count for the user that has logged in is displayed.



• **To limit the number of pages that a user can use:**

In "Settings (administrator)", select [User Control] → [Pages Limit Group].

• **To hide the number of pages that can be used after login:**

In "Settings (administrator)", disable [User Control] → [Default Settings] → [Display Usage Status after Login].

• **To change the message display time:**

In "Settings" (administrator)", select [System Settings] → [Common Settings] → [Operation Settings] → [Condition Settings] → [Message Time Setting].



When the user number is an 8-digit number, this step is not necessary. Login takes place automatically after the user number is entered.

3

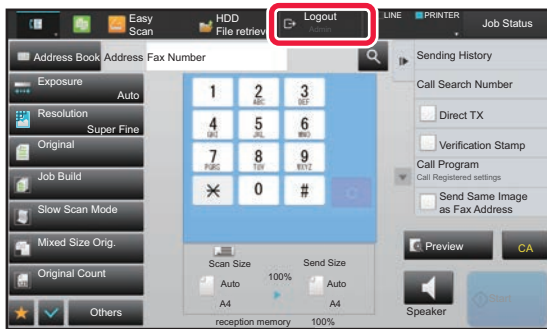

When you have finished using the machine and are ready to log out, tap [Logout].



AUTHENTICATION BY LOGIN NAME/PASSWORD

This method enables users to log in using a login name and password received from the administrator of the machine or the administrator of the LDAP server.

When starting the machine, the login screen appears.

The screenshot shows a 'User Authentication' screen with the following elements:

- Title: User Authentication
- Instruction: Enter login name and password.
- Fields:
 - Login Name: Touch to input Log-in Name
 - Password: Touch to Input Password
- Buttons: Select from List, Login Locally, CA, OK

When controlled by login name and password



- Different items may appear in the screen when LDAP authentication is used.
- When LDAP authentication is used, the [E-mail Address] key may appear, depending on the authentication method. Tap the [E-mail Address] text box and enter your e-mail address.

This screenshot is similar to the previous one but includes an additional field:

- Title: User Authentication
- Instruction: Please enter Log-in name/E-mail address/password.
- Fields:
 - Login Name: Touch to input Log-in Name
 - E-mail Address: Touch to input E-mail Address (highlighted with a red box)
 - Password: Touch to Input Password
- Buttons: Select from List, Login Locally, CA, OK



If "A Warning when Login Fails" is enabled in the system settings, the operation panel will be locked for five minutes if an incorrect login name or password is entered three times in a row. Contact the machine administrator to check the login name/password assigned to you.



- **To release the operation panel lock:**
In "Settings (Web version)", select [User Control] → [Default Settings] to release the lock.
- **To set [A Warning when Login Fails]:**
In "Settings (administrator)", select [User Control] → [Default Settings] → [A Warning when Login Fails].
- **To store a user name:**
In "Settings (administrator)", select [User Control] → [User List].
Also register detailed information such as the login name, user number, and password. Ask the administrator of the machine for the information that you need to use the machine.



1

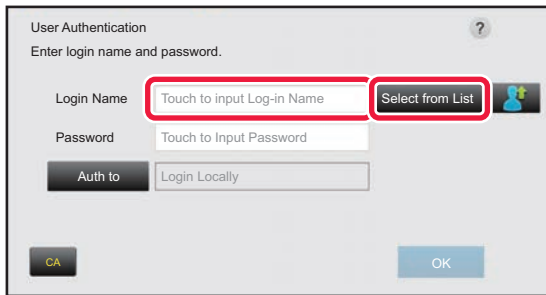

Enter the login name.

Entering using the soft keyboard

If user name registration has not been performed in setting mode, a user only using LDAP authentication should tap the [Login Name] text box and enter the login name using the soft keyboard.

Selecting from a list

Tap the [Select from List] key and select a user name from the User List screen.



LDAP authentication can be used when the administrator of the server provides LDAP service on the LAN (local area network).

2

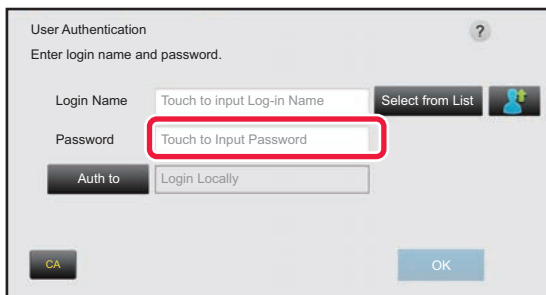

Enter the password.

Enter the password from the soft keyboard.

If you are logging in to an LDAP server, enter the password that is stored with your LDAP server login name.

Each entered character will be displayed as "*". After entering the password, tap the [OK] key.

When authentication is by LDAP server and you have different passwords stored in "User List" and in the LDAP server, use the password stored in the LDAP server.



To have the user name and password registered:

In "Settings (administrator)", select [User Control] → [User List].



When registering the LDAP server, change the information for [Auth to] as required.

- **When selecting from the User List screen:**

The LDAP server you are connecting to has been registered upon user registration, and so the target server to which authentication should be directed appears when the login name is selected.

Go to step 3.

- **When entering from the soft keyboard:**

Tap [Auth to] and select the LDAP server to log in.



3

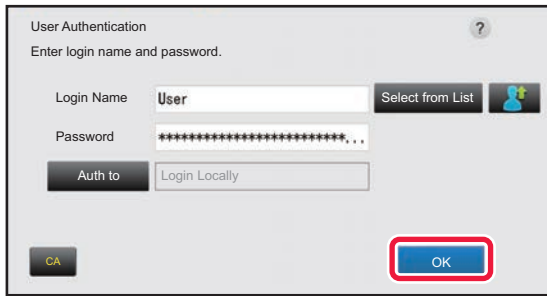

Tap the [OK] key.

If the entered login name and password are authenticated, the number of remaining pages that the user can copy or scan is displayed.

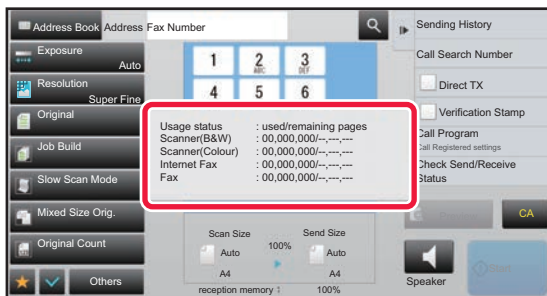

When a limitation is set for the number of pages that a user can use, the use count for the user that has logged in is displayed.



- **To limit the number of pages that a user can use:**
In "Settings (administrator)", select [User Control] → [Pages Limit Group].
- **To hide the number of pages that can be used after login:**
In "Settings (administrator)", disable [User Control] → [Default Settings] → [Display Usage Status after Login].
- **To change the message display time:**
In "Settings" (administrator), select [System Settings] → [Common Settings] → [Operation Settings] → [Condition Settings] → [Message Time Setting].

4

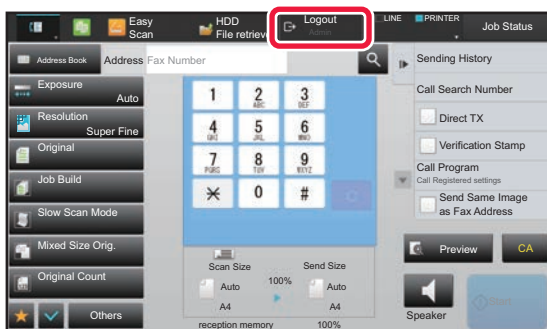

When you have finished using the machine and are ready to log out, tap [Logout].



ACTIVE DIRECTORY LINKING FUNCTION

You can join the Active Directory domain (AD domain) of the machine, and easily perform user management on the network.

On a network that does not have Active Directory enabled, you must perform network device authentication for each device.

For this reason, one user must have multiple domain names and passwords.

When you join an AD domain, you only need to be authenticated once. After you are authenticated, the Active Directory server automatically authenticates network devices. You can log in to multiple devices on the network with a single domain name and password.

Joining an AD domain

To have the machine join an AD domain, set the authentication destination to [Active Directory] in "Settings (administrator)" - [User Control]→[Default Settings]→[Authentication Server Settings].



When the authentication destination is set to Active Directory, the Kerberos setting cannot be used.

Registering the machine in an AD domain

When you join an AD domain, the machine is registered as a printer in the AD domain. Enter the machine information in setting mode.

Device name of the machine

In "Settings (administrator)", select [System Settings] → [Network Settings] → [Network Name Setting] → [Device Name].

Domain name of the machine

In "Settings (administrator)", select [System Settings] → [Network Settings] → [Active Directory Settings] → [Domain Name].

Machine user name and password

In "Settings (administrator)", select [System Settings] → [Network Settings] → [Active Directory Settings] → [Device Registration Account].

DNS domain name

In "Settings (administrator)", select [System Settings] → [Network Settings] → [Services Settings] → [DNS] → [Domain Name].



User authentication in the AD domain

The following methods can be used for user authentication in the AD domain.

1. Authentication by manual entry on the machine

Perform authentication using the touch panel of the machine. For the authentication method, refer to "[AUTHENTICATION BY LOGIN NAME/PASSWORD \(page 1-34\)](#)".

Configure the following setting in "Settings (administrator)".

Disable "Settings (administrator)"→[User Control]→[Default Settings]→[Use IC Card for Authentication].

2. Login by IC card (Quick Mode)

Use the card ID registered in an IC card to perform AD domain authentication.

When you first perform authentication, you must enter your password. After that you can perform authentication with just your IC card.



If you change your password on the Active Directory server, your initially entered password information will be reset and you will need to enter your password again.

Configure the following settings in "Settings (administrator)".

Enable "Settings (administrator)"→[User Control]→[Default Settings]→[Use IC Card for Authentication].

Enable "Settings (administrator)"→[User Control]→[Default Settings]→[Cache Password for Authentication].

3. Login by IC card (security card)

Use the card ID registered in an IC card to perform AD domain authentication.

You must always enter your password when you perform authentication using an IC card.

Enable "Settings (administrator)"→[User Control]→[Default Settings]→[Use IC Card for Authentication].

Disable "Settings (administrator)"→[User Control]→[Default Settings]→[Cache Password for Authentication].



- You can use both AD domain authentication users and users set on the machine. In this case, the authentication destination is set when logging in.
- When an AD domain authentication user reserves a job and logs out before the job is executed, the user information is temporarily stored in the machine and the reserved job is executed.



Functions that can be used by linking with Active Directory

User accessible network folders

When a user who has logged in to the AD domain accesses a network folder from the machine, the user can only access a folder for which he has permission.

Shared folder

When a logged in user taps the [Browse] key for a shared folder address, only folders for which the user has permission are displayed.

Document filing

When a logged in user taps [Select File from Network Folder to Print] on the action panel in document filing and then taps [Refer to Folders on Network], only folders for which the user has permission are displayed.

Home Directory

Scan to Home Directory

When scanning, a logged in user can use his Home Directory property that is set in the AD domain to send the scanned file to that folder.

To use this function, enable "Settings (administrator)" → [System Settings] → [Image Send Settings] → [Scan Settings] → [Default Address] → [Apply Home Directory of The User for Login].

Shared folder

In the shared folder address, the path of the logged in user's Home Directory is automatically entered in [Path Input to Folder]. The folder that appears after the [Browse] key is tapped is the user's Home Directory.



If the Active Directory server cannot be accessed, the [Path Input to Folder] field will be blank, and when the [Browse] key is tapped, the search results of the entire network will appear.

Print from Home Directory

The logged in user's Home Directory property that is set in the AD domain can be used to set the print folder for printing to the Home Directory.

Shared folder

When the user taps [Select File from Network Folder to Print] on the action panel in document filing and then taps [Refer to Folders on Network], the folder that appears is the user's Home Directory.



- When authentication information is stored in the address book and the user sends a file by specifying an address in the address book, the file is sent according to the user's permissions in the address book. If authentication information is not stored in the address book, the file is sent according to the logged in user's authentication permissions.
- In AD domain authentication mode, a file can be sent to a shared folder using the logged in user's authentication permissions. In this case, a user name and password cannot be entered manually.

E-Mail

Scan to E-Mail

A logged in user can use his mail property set in the AD domain to send a scanned image to himself by e-mail.

To apply the e-mail address of the logged-in user set in the AD domain, tap [Find My Address] which appears on the action panel when e-mail is sent, or enable [Apply E-mail address of the user for login.] in "Settings (administrator)" → [System Settings] → [Image Send Settings] → [Scan Settings] → [Default Address].



BILLING CODE

BILLING CODE

A billing code, which is added to a recorded job log when a printing or sending job has been executed, is used to perform billing processing.

Billing codes are classified into two types: main code and sub code. A billing code is recorded in the job log when it is entered and a print or send job is executed.

Summing up the amounts by Billing Code based on the job logs will facilitate the subsequent operations, for instance, when making combined billings.

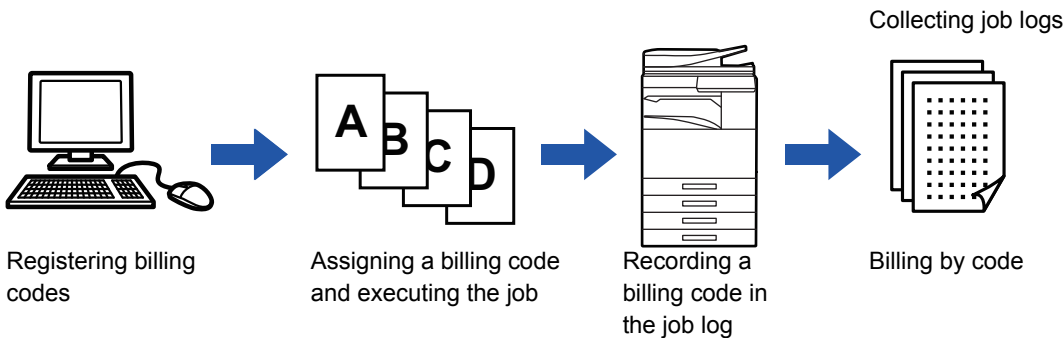

Types of billing codes

Type	Description
Main Code	Used to categorize the results of the executed print and send jobs to enable efficient management. For example, you can assign a code by customer and collect cost information by customer from job logs. Code example: Issue of company A
Sub Code	Available when the main code alone is not sufficient to enable management of billing codes. For example, you can assign monthly cost information to a sub code and collect the total monthly cost information of all customers when the customer name is assigned to the main code. Code example: Issue of April, 2015
Default Code	Automatically assigned when the main code or sub code has not been specified.

Enable use of billing code

To enable use of the billing code, select "Settings (administrator)" → [User Control] → [Billing Code] → [Administration Settings], then set [Use Billing Code] to [Enable].

Collecting billing codes

In "Settings (Web version)", select [System Settings] → [System Control] → [Job Log] → [Job Log Operation], and click [Save] button to download the job logs. Then sum up the data by classifying and arranging the stored job logs.



USE BILLING CODE

If the use of billing code is enabled in "Settings (administrator)", the billing code entry window is displayed at the time of mode transition (at the time of printing/sending in document filing mode).

Enter the main code or sub code as required.



- **To enable use of the billing code**

Select "Settings (administrator)" → [User Control] → [Billing Code] → [Administration Settings], then set [Use Billing Code] to [Enable].

- **To retain the specified billing code at the time of mode transition**

Select "Settings (administrator)" → [User Control] → [Billing Code] → [Administration Settings], then set the [Remember Billing Code Between Modes] check box to . This eliminates the need to enter billing codes at each mode transition.



You can assign billing codes to reprinting/resending of target files and sending of print jobs from "Settings (Web version)" → [Document Operations].

Specifying a billing code again

To change the specified billing code to another one, tap [Switch Billing Code.] on the action panel.

When the billing code entry window is displayed, select a new billing code.

Select a billing code from the list

Select the desired billing code from the list of registered billing codes.

You need to register billing codes in advance.

► [REGISTERING A NEW BILLING CODE \(page 1-44\)](#)

1

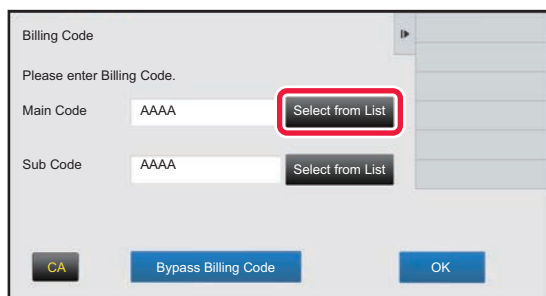

When the billing code entry window is displayed, tap the [Select from List] key of the main code.



- **When not specifying a billing code**

Tap the [Bypass Billing Code] key.



- **To select the previously used billing code (at the time of user authentication)**

Tap [Use Previously-Used Billing Code] on the action panel at the time of user authentication; this displays the main code and sub code the authenticated user has entered previously.



2

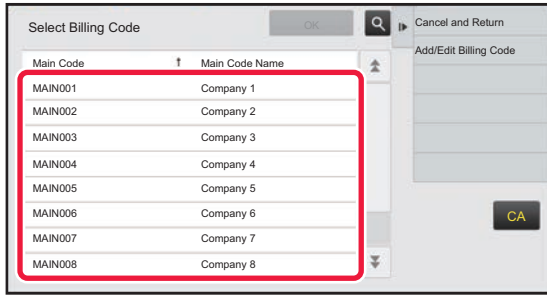

Tap and select the main code from the list.



To search for the main code or main code name

Tap . When the search window is displayed, enter the main code and main code name, then tap the [Search Start] key. The search result list is displayed.

3

Tap the [OK] key.

Returns the screen to the billing code entry window.



To cancel the selection from the list

Tap [Cancel and Return] on the action panel. This cancels the selected main code and returns the screen to the billing code entry window.



To check the details of the main code

Tap [Display Details] on the action panel. The detail window is displayed. Check the details, then tap .

4

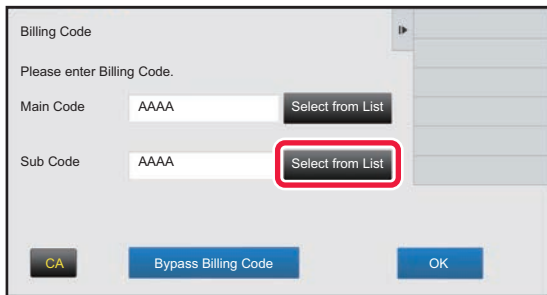

Tap the [Select from List] key of the sub code.

The sub code list is displayed. Perform the procedure shown in steps 2 and 3, then specify the sub code.

5

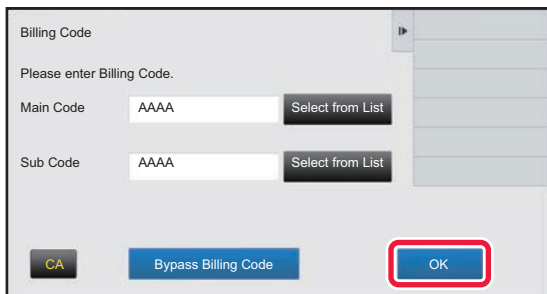

Tap the [OK] key.



To clear the value of the specified billing code

Tap the [CA] key. Enter the billing code again.



Directly entering a billing code

1

Billing Code

Please enter Billing Code.

Main Code Select from List

Sub Code Select from List

CA Bypass Billing Code OK

When the billing code entry window is displayed, tap the box in [Main Code], then enter the main code.

Specify the code using up to 32 single-byte characters.



When not specifying a billing code

Tap the [Bypass Billing Code] key. The use code is set to the main code.

2

Billing Code

Please enter Billing Code.

Main Code Select from List

Sub Code Select from List

CA Bypass Billing Code OK

Tap the box of [Sub Code], then enter the sub code.

Specify the code using up to 32 single-byte characters.

3

Billing Code

Please enter Billing Code.

Main Code Select from List

Sub Code Select from List

CA Bypass Billing Code OK

Tap the [OK] key.



To clear the value of the specified billing code

Tap the [CA] key. Enter the billing code again.



REGISTERING A NEW BILLING CODE

Register a new billing code.

A billing code can be registered not only from the billing code entry window but also from "Settings".



To register a billing code from Setting Mode

Select "Settings" → [User Control] → [Billing Code] → [Main Code List] or [Sub Code List]. Register a main code in [Main Code List], and a sub code in [Sub Code List].



A total of up to 2000 main and sub codes can be registered.

Shared range of billing code

The registered billing codes can only be shared in the specified group at the time of user authentication.

If the shared range is not specified, the registered billing codes are shared by all users.



To register a user group

In "Settings (administrator)", select [User Control] → [Organization /Group List].

1

Billing Code

Please enter Billing Code.

Main Code: AAAA [Select from List]

Sub Code: AAAA [Select from List]

[CA] [Bypass Billing Code] [OK]

When the billing code entry window is displayed, tap [Select from List] of the main code.

To register a new sub code, tap the [Select from List] key of the sub code.

The subsequent steps are the same as the main code.

2

Select Billing Code

Main Code	Main Code Name
MAIN001	Company 1
MAIN002	Company 2
MAIN003	Company 3
MAIN004	Company 4
MAIN005	Company 5
MAIN006	Company 6
MAIN007	Company 7
MAIN008	Company 8

[Add/Edit Billing Code]

[CA]

Tap [Add/Edit Billing Code] on the action panel



3

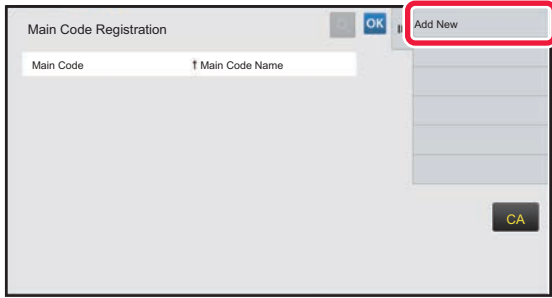

Tap [Add New] on the action panel.



To return to the billing code selection window
Tap **OK**.

4

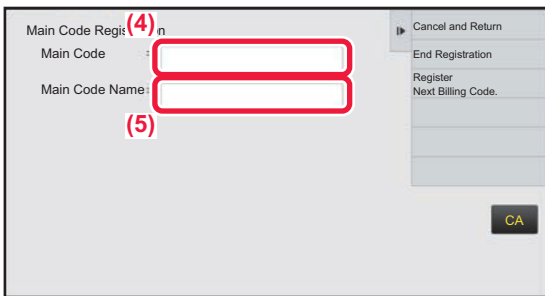

Tap the box of [Main Code], then type in the main code.

Specify the code using up to 32 single-byte characters.

5

Tap the box of [Main Code Name], then type in the main code name.
Specify the code name using up to 32 double- or single-byte characters.

6

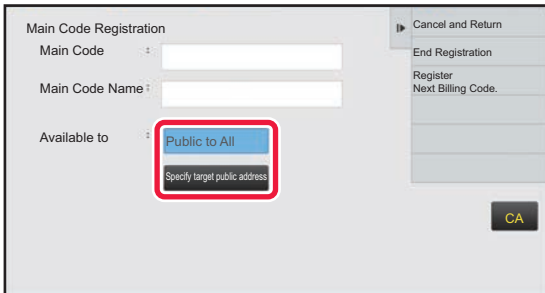

If necessary, select the share range of billing code.

Public to All: Registers the billing code as a public code for all users who use the machine.
Specify target public address: Limits the share range of billing code to be registered only to the specified group. Up to eight groups can be specified as a public destination.

For details on how to specify a public destination, refer to "[Shared range of billing code \(page 1-44\)](#)".



The public destination of a billing code is not displayed if user authentication is not performed. The mode is automatically set to [Public to All].



7

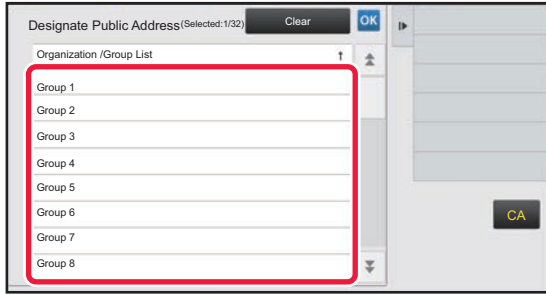

Tap and select a group as a public destination

Up to eight groups can be specified. After the settings are completed, tap **OK**.



To cancel the setting

Tap [Clear] on the action panel. This cancels the registered public destination and returns the screen to the previous window.

8

To continuously register other billing codes, tap [Register Next Billing Code.].

Execute steps 4 to 7 to register the main code.



To cancel the registration

Tap [Cancel and Return] on the action panel. This cancels all the registered billing codes and returns the screen to the previous window.

9

Tap [End Registration] on the action panel.

This finalizes the registration and returns the screen to the previous window. Tap **OK** to finish the registration procedure.



To return to the billing code entry window

Tap the [CA] key.



EDITING OR DELETING THE REGISTERED BILLING CODE

You can change or delete the registered billing code.
The billing code can also be edited or deleted from "Settings".



To edit or register a billing code from Setting mode

Select "Settings" → [User Control] → [Billing Code] → [Main Code List] or [Sub Code List]. Edit or register a main code in [Main Code List], and a sub code in [Sub Code List].

Editing a billing code

1

When the billing code entry window is displayed, tap the [Select from List] key of the main code.

To register a new sub code, tap the [Select from List] key of the sub code.
The subsequent steps are the same as the main code.

2

Tap [Add/Edit Billing Code] on the action panel.

3

Tap and select the main code to be edited, then tap [Edit] on the action panel.



To return to the billing code selection window

Tap **OK**.



4

Main Code Registration

Main Code : AAAA

Main Code Name : AAAA

Available to : Public to All

Specify target public address

Cancel and Return

End Registration

Register

Next Billing Code.

CA

Edit the main code as required.

For information on how to correct the code, refer to steps 4 to 7 in "[REGISTERING A NEW BILLING CODE \(page 1-44\)](#)".

5

Tap [End Registration] on the action panel.

This finalizes the registration and returns the screen to the previous window. Tap **OK** to finish the registration procedure.



To return to the billing code entry window

Tap the [CA] key.



Deleting a billing code

1

Billing Code

Please enter Billing Code.

Main Code: AAAA [Select from List]

Sub Code: AAAA [Select from List]

[CA] [Bypass Billing Code] [OK]

When the billing code entry window is displayed, tap the [Select from List] key of the main code.

To delete a sub code, tap the [Select from List] key of the sub code.

The subsequent steps are the same as the main code.

2

Select Billing Code

Main Code	Main Code Name
MAIN001	Company 1
MAIN002	Company 2
MAIN003	Company 3
MAIN004	Company 4
MAIN005	Company 5
MAIN006	Company 6
MAIN007	Company 7
MAIN008	Company 8

[Add/Edit Billing Code] [Cancel and Return] [CA]

Tap [Add/Edit Billing Code] on the action panel.

3

Main Code Registration

Main Code	Main Code Name
MAIN001	Company 1
MAIN002	Company 2
MAIN003	Company 3
MAIN004	Company 4
MAIN005	Company 5
MAIN006	Company 6
MAIN007	Company 7
MAIN008	Company 8

[Add New] [Delete] [CA]

Tap and select the main code to be deleted, then tap [Delete] on the action panel.



To return to the billing code selection window

Tap [OK].

4

When the confirmation message appears, tap the [Delete] key.



CLOUD LINK

The Cloud Link function is used to connect the machine to a cloud service on the Internet, enabling you to upload scanned data and print data stored in the cloud.

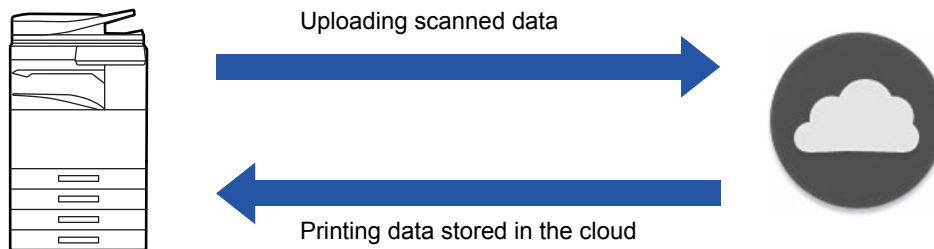

The machine can connect to the following cloud services:

- Microsoft OneDrive for Business
- Microsoft SharePoint Online
- Google Drive

BEFORE USING THE CLOUD LINK FUNCTION

This section explains settings that must be configured before you can use the Cloud Link function.

Settings required on the machine

Configuring system settings

Configure settings for connection of the machine to the Internet (proxy settings, etc.) as required for your network environment.

In addition, you must configure the following settings on the machine in order to use the "OneDrive for Business Link" and "SharePoint Online Link" functions.

Configure these settings in "Settings (administrator)" → [System Settings] → [Network Settings] → [External Service Connect] → [Cloud Connect Settings].

Set the cloud link icon in the home screen.

1

Tap [Edit Home] on the action panel.

2

In home edit mode, tap an unused shortcut key.

3

Tap [Google Drive], [OneDrive], or [SharePoint Online].

4

Tap [Exit Home Edit Mode] on the action panel.

Exit home edit mode and return to the home screen.



To edit the home screen, refer to the "U/I Customize Guide".



UPLOADING SCANNED DATA TO A CLOUD SERVICE

This section explains how to upload data scanned on the machine to a cloud service.

1

Tap [Google Drive], [OneDrive], or [SharePoint Online] in the home screen.

- The login screen of the selected cloud service appears.
- When user authentication is enabled on the machine, the login screen will not appear after the first time you successfully log in to the cloud service.



When using OneDrive or SharePoint Online, you can only login using your standard Office 365 user account for ID/password authentication.

2

Enter your user account information for the cloud service.

A screen for selecting tasks appears.

3

Tap the [Scan a document] key.

- The scan settings screen appears.
- Specify a "File Name", "Address", and "Upload Data Scan Settings".

4

Execute Scan or Preview.

PRINTING DATA IN A CLOUD SERVICE

This section explains how to use the machine to print data in a cloud service.

1

Tap [Google Drive], [OneDrive], or [SharePoint Online] in the home screen.

- The login screen of the selected cloud service appears.
- When user authentication is enabled on the machine, the login screen will not appear after the first time you successfully log in to the cloud service.



When using OneDrive or SharePoint Online, you can only login using your standard Office 365 user account for ID/password authentication.

2

Enter your user account information for the cloud service.

A screen for selecting tasks appears.



3

Tap the [Print a document] key.

- The file selection screen appears.
- Tap the [Narrow Down] key to filter files by file extension. Select the file type you want to use to filter the files.
- Select the file and tap the [Change Setting to Print] key to display the print settings screen.



File formats that can be printed are DOCX, PPTX, XLSX, PDF, PS, PRN, PCL, TIFF, TIF, JFIF, JPE, JPEG, JPG, and PNG. On the MX-2630N/MX-3050V/MX-3550V/MX-4050V/MX-5050V/MX-6050V, the Direct print expansion kit is required for DOCX, PPTX, and XLSX files.

4

Execute printing

Cautions when using the Cloud Link function

- Print results using the Cloud Link function may not have the same quality as print results using other print methods (printer driver, etc.).
The contents of some files may cause incorrect printing or prevent printing.
- It may not be possible to use some or all Cloud Link functions in some countries or regions where the machine is used.
- It may not be possible to use the Cloud Link function in some network environments. Even when the Cloud Link function can be used, processing may require a longer time or may be interrupted.
- We do not extend any guarantees regarding the continuity or connection stability of the Cloud Link function.
With the exception of instances provided for by law, we bear absolutely no responsibility for any damages or loss suffered by the customer due to the above.

“DirectOffice™ is a product of CSR Imaging US, LP.

DirectOffice™ is a trademark of CSR Imaging US, LP, registered in the United States and other countries, used with permission.”



AirPrint

The procedure for printing or sending a file on the machine using AirPrint is explained here.



On the MX-2630N/MX-3050V/MX-3550V/MX-4050V/MX-5050V/MX-6050V, the PS3 expansion kit is required to use AirPrint. To send a fax by AirPrint, the facsimile expansion kit is required.



To enable AirPrint

In "Settings (administrator)", select [System Settings] → [Network Settings] → [External Print Services Settings] → [AirPrint Settings].

Before using AirPrint

To use AirPrint on OS X, you must first register the machine's information in your device.

Advance settings are not necessary to use AirPrint on iOS.

Enable AirPrint in the machine's settings, and also enable AirPrint on your device.

- (1) Click [Printers & Scanners] ([Print & Scan]) in System Preferences.**
- (2) Click the [+] button.**
- (3) Select the name of the machine from the list, select [AirPrint] from the drivers, and click [Add].**
Setup starts, and the machine can be used with AirPrint.

Using AirPrint to print

The printing procedure depends on the application. The procedure for printing a Web page viewed in the iOS version of Safari is explained below as an example.

- (1) Open the page that you want to print in Safari.**
Use the commands in Safari to open the page you want to print.
- (2) Tap .**
- (3) Tap [Print].**
The menu appears. Tap [Print].
- (4) Select the printer.**
AirPrint compatible printers on the same network as the device are shown. Select the machine.
- (5) Select print settings and tap [Print].**
Set the number of copies and other settings as needed and tap [Print].



- When you send the print job with a PIN code from your device, the print job is saved in the main folder of document filing.
- The screen that appears varies depending on your OS version.
- The functions that can be used when printing with AirPrint vary depending on the OS and the application.
- To print with AirPrint when the machine's user authentication function is used, enable [Enable IPP Authentication Except for Printer Driver] in "Settings (Administrator)" → [System Settings] → [User Control] → [Default Settings].
- To print in colour, you must change the permission of "Other User" to a permission that allows colour printing.



Using AirPrint to send a fax

You can send a file created in an AirPrint compatible application by fax via the machine.

The sending procedure depends on the application.

Refer to the manual for the application to send a file by fax. The procedure for transmission in OS X is explained as an example.

- (1) Open the file you want to send.**
- (2) Select [Print] from [File] in the application.**
- (3) Select the machine - fax in [Printer].**
- (4) Enter the fax number in the address. When finished selecting settings, click [Fax].**

Fax transmission starts.



- AirPrint can be used to send a fax even when [Disable PC-Fax Transmission] is enabled.
- Fax jobs sent using AirPrint are managed in the same way as resend jobs in Document Filing.
- To send a fax with AirPrint when the machine's user authentication function is used, enable [Enable IPP Authentication Except for Printer Driver] in "Settings (Administrator)" → [System Settings] → [User Control] → [Default Settings].

Using AirPrint to send a scanned document

You can scan a document on the machine using an AirPrint-compatible application, and send the scanned document to a device.

The sending procedure depends on the application.

Refer to the manual for the application to send a scanned document. The procedure for scanning in OS X is explained here as an example.

- (1) Place the original.**
- (2) Click [Printers & Scanners] ([Print & Scan]) in System Preferences.**
- (3) Select the machine from the "Printer" list, click [Scan], and click [Open Scanner].**
- (4) When you have finished selecting settings, click [Scan].**

Scanning starts.



- To send a document using AirPrint, the machine must be in one of the following states:
 - Login screen displayed, home screen displayed, brightness adjustment screen displayed, display language being set, home being edited, custom display pattern being set, home screen text colour being changed, administrator password being entered for home edit / custom display pattern setting / home screen text colour change, login name / password being entered, numbers being entered for authentication by number, login user being selected, authentication destination being selected
- When the machine's user authentication function is used, an image scanned with AirPrint is treated as an invalid user job.



EASY CONNECTION WITH A MOBILE DEVICE (EASY CONNECT)

You can connect a NFC card reader to the machine to easily connect to a smartphone or other mobile device. By installing the dedicated application in the mobile device in advance, the application will start automatically after the device connects to the machine, allowing you to print immediately. You can also connect by displaying a QR code on the machine's touch panel and scanning the code with a mobile device that has a dedicated application installed.



- For NFC card readers and dedicated applications that can be used, consult your dealer or nearest authorised service representative.
- For information on connecting the NFC card reader to the machine, refer to the manual for the NFC card reader.
- A wireless LAN adapter is required to use this feature on the MX-2630N/MX-3050V/MX-3550V/MX-4050V/MX-5050V/MX-6050V.

CONNECTING BY NFC CARD READER

You can easily connect a mobile device to the machine by holding it to the NFC card reader. In addition, by installing the dedicated application on your mobile device, the application will automatically start when the device connects to the machine, allowing you to send data and print to the machine right away. Configure settings on the machine in advance to enable use of an NFC card reader and wireless LAN.



This function can only be used on an Android device.

1

Hold your mobile device to the NFC card reader



If the machine is in the auto power shutoff state, holding your mobile device to the NFC card reader will wake the machine. However, if [Sleep Mode] is set to [Energy Saving Priority], you must wake the machine manually.

2

Connecting to the Machine from a Mobile Device

The machine and mobile device automatically start the connection.

If a dedicated application is not installed on your mobile device, your mobile device will automatically go to an Android application store (Google Play, etc.) and download a dedicated application.

If the dedicated application is installed on your mobile device, it will start.

You can print and scan from the application.



CONNECTING BY QR CODE

You can connect by displaying the QR code on the machine's touch panel and then having your mobile device (with the dedicated application already installed) read the QR code.

The machine sends the information required for connection to the mobile device, and the information is saved. No settings are required on the mobile device, and setup is quickly accomplished.

Configure settings on the machine in advance to enable connection by QR code.



This function can be used on an Android device and on an iOS device.

1

Tap the [Easy Connect (QR code)] key in the home screen.

The QR code appears on the touch panel.

In advance, enable QR codes in [Easy Connection Setting] in Settings (administrator), and enable display of the [Easy Connect (QR code)] key in [Home Screen Settings].

2

Start the dedicated application on your mobile device

3

Read the QR code on the touch panel with your mobile device



The QR code is the machine's connection information. This information is saved on your mobile device. You can also set an external access point as the connection destination.



• To use Easy Connect

Configure in "Settings (administrator)" - [System Settings] - [Network Settings] - [Easy Connection Setting].

• To Show the [Easy Connect (QR code)] key in the home screen

Configure in "Settings (administrator)" - [System Settings] - [Home Screen Settings] - [Condition Settings] - [Home Screen Registration].



NAS

NAS (Network Attached Storage) is a storage device that is connected to the network.

You can use part of the machine's hard drive area as a simple file server to save files and browse saved files.

Folder structure

The folder structure is as follows.

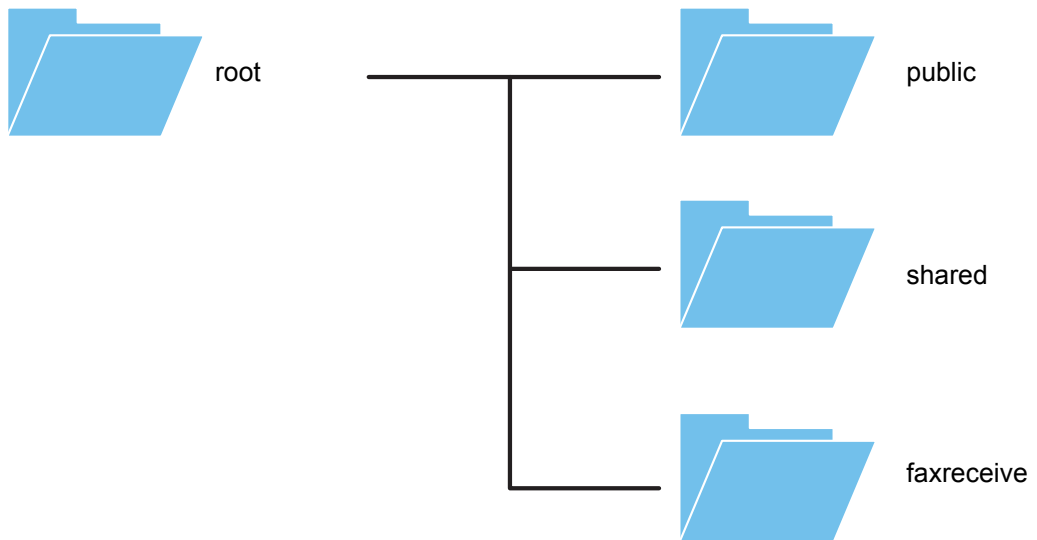

- root
- public: Area for storing PDF files for PC browsing that have been created using the document filing function.
- shared: Area where you can freely create folders.
- faxreceive: Area for storing received data using the received data HDD storage function.



To use NAS

- Set the folder that you want to allow to be used to [Allow] in "Settings (administrator)" - [System Settings] → [Network Settings] → [Public Folder / NAS Setting]. (The factory default setting is "Allow".)
- Set the NBT/WINS setting of the server port to [Valid] in "Settings (administrator)" - [System Settings] → [Security Settings] → [Port Control]. (The factory default setting is "Invalid".)



Saving files in NAS / browsing NAS files

1

You can save data that you need to the machine's hard disk, and view the data on your computer.

Document scanned on the machine

In document filing, tap the [Create PDF for PC Browsing] checkbox so that it is selected , and copy to the public folder to save the data.

► [Creating PDF for PC browsing \(page 6-13\)](#)

Received fax data

Configure "Settings (administrator)" - [System Settings] → [Image Send Settings] → [Inbound Routing (Forwarding/Storing) Settings] → [Inbound Routing (Storage) Settings].

► [SAVING RECEIVED FAXES TO THE MACHINE'S HARD DISK \(INBOUND ROUTING\) \(page 4-68\)](#)

2

Using as a file server / browsing saved files.

To use this, open any folder screen on your computer and enter the IP address of the machine after "\\" in the address bar (example: \\192.168.1.28).



- Access restrictions are set for each folder, so you must enter the login name and password of the administrator account or of a user account that has been registered in the machine.
 - The maximum size per file is 2 GB.
-



REMOTE OPERATION OF THE MACHINE

Remotely operate the machine on your computer.

You can operate the machine from the same panel as the machine's operation panel that is displayed on your PC, with the same feel as operating in front of the machine.

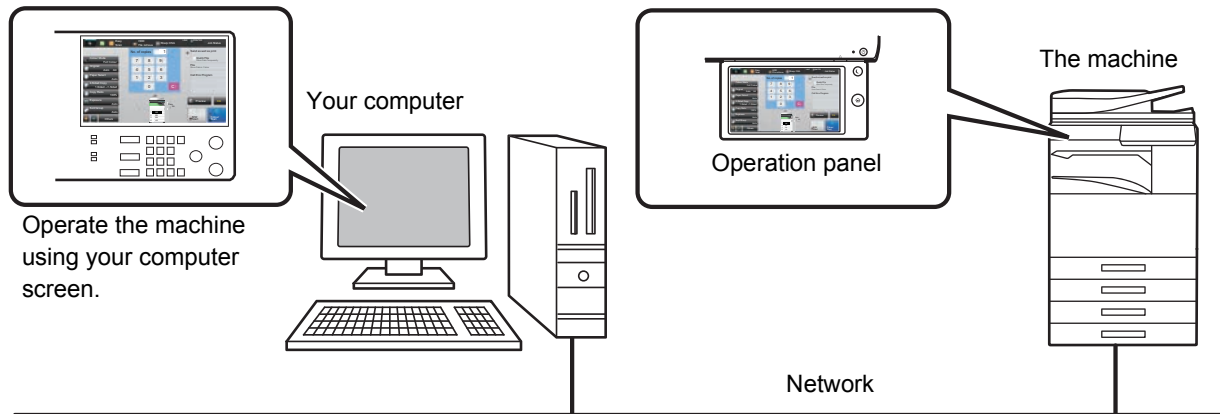

The remote operation function can only be used on one computer at a time.

Before you can use the remote operation function, the following preparation is required.

- In "Settings (administrator)", select [System Settings] → [Common Settings] → [Operation Settings] → [Condition Settings] → [Remote Operation Settings] → [Remote Software Operation] and select [Allow] for [Operational Authority].
- Connect the machine to the network.
- Install a VNC application software (recommended VNC software: RealVNC) in your computer.

After the preparation is completed, follow the operation described below to set up the function.

Example: RealVNC

1

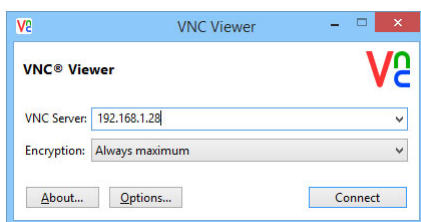



Start the VNC viewer, enter the IP address of the machine in the "VNC Server" entry box, and click the [Connect] button.



Check with the administrator of the machine for its IP address.

2

Follow the message on the operation panel of the machine to permit the connection.

When the machine is connected to a VNC application software,  appears on the system bar of the machine's touch panel. If you wish to disconnect, exit the VNC application software or tap .



Use the operation panel in the same way as you would on the machine. However, you cannot enter values in series by continuously clicking the key.



UNIVERSAL DESIGN IN THE MACHINE

The structure of the machine and the software are designed to allow all people to use the machine with ease.

UNIVERSAL DESIGN RELATED TO OPERATION

Adjustment of operation panel angle

The angle of the entire operation panel can be adjusted to enable use even when seated.

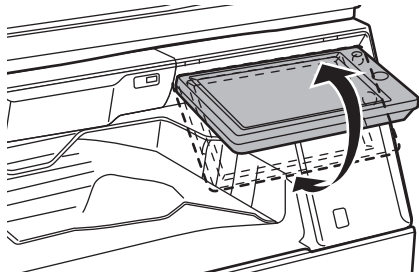

Grip handle on paper trays

The grip-type handles allow easy use from above or below. By simply placing your hand on a handle and gently pulling forward, the lock releases. The trays can be manipulated in a natural manner.

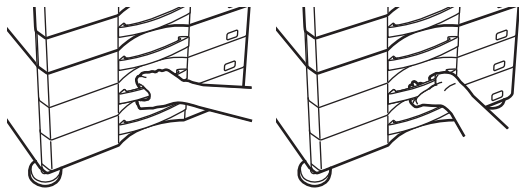

Changing of key response time

The response time of the keys can be changed as needed.

In "Settings" (administrator), select [System Settings] → [Common Settings] → [Operation Settings] → [Condition Settings] → [Key Operation Setting].

- **Time for Accepting Key Entry**

This setting determines how long a key in the touch panel must be tapped until the key input is registered. The time can be set from 0 to 2 seconds in increments of 0.5 seconds.

By lengthening the time setting, key input can be prevented when a key is tapped accidentally. Keep in mind, however, that when a longer setting is selected more care is required when tapping keys to ensure that key input is registered.

- **Disable Auto Key Repeat**

This is used to disable key repeat.

Key repeat causes a setting to change continuously not only each time the key is tapped but while a key is tapped.

- **Long-touch Detection Time**

Select a time when a long key touch is detected.

- **Double Tap Speed Interval**

Select an interval when a double tap is detected.



Confirmation of placement of original in document feeder

You can use the data notification indicator to check if an original has been correctly placed in the auto document feeder. Select "Settings (administrator)" → [System Settings] → [Common Settings] → [Device Control] → [Data Indicator Setting], then set to [Pattern 3].

UNIVERSAL DESIGN RELATED TO VISION

Changing of text size

The size of the text on the touch panel can be changed. When the text on the touch panel is small and difficult to read, the text can be enlarged.

In "Settings" (administrator), select [System Settings] → [Common Settings] → [Operation Settings] → [Condition Settings] → [Enlarge Display Mode].

- **Enlarge Display Mode**

Displays large characters on the screen.

 appears in the system area when Enlarge Display Mode is enabled.

UNIVERSAL DESIGN RELATED TO HEARING

Audible alert sounds when changing settings

When moving through copy ratio or exposure settings, the user is alerted by an audible sound at the default setting (copy ratio 100%, exposure 3).

In "Settings (administrator)", select [System Settings] → [Common Settings] → [Operation Settings] → [Condition Settings] → [Keys Touch Sound] and [Make Key Touch Sound at Default Setting].

- **Keys Touch Sound**

Controls the key touch sound level, or turns the sound off. You can also have three peeps sound at initial values when setting the ratio in copy mode or when adjusting the exposure in any mode.

Screen in which setting is effective	Initial value
Ratio setting screen in base screen of copy mode	Ratio 100%
Exposure setting screen in base screen of copy mode	Exposure level: 3 (medium)
Exposure adjustment screen in base screen of fax, Internet fax, and network scanner modes	
Exposure adjustment screen for Scan to HDD in document filing mode	

- **Make Key Touch Sound at Default Setting**

When you specify the exposure in the exposure adjustment screen of each mode, a bleep sounds three times when the reference value is reached.



UNIVERSAL DESIGN FEATURES

The machine has design features and settings that are compatible with universal design.

Easy-to-use user interface

• Simple mode

This mode shows only frequently used items. Buttons and text are enlarged to increase ease of operation. Almost all regular operations can be completed using the simple mode screen.

- ▶ [COPY MODE \(page 2-3\)](#)
- ▶ [FAX MODE \(page 4-7\)](#)
- ▶ [NETWORK SCANNER MODE \(page 5-8\)](#)

• Customizing the home screen and adding icons

You can add icons to the home screen. You can also change an icon image to a custom image.

Add an icon image in "Settings (administrator)" - [System Settings] → [Home Screen Settings] → [Icon].

To add an icon to the home screen, add a key in "Settings (administrator)" - [System Settings] → [Home Screen Settings] → [Condition Settings] → [Home Button]/[Fix Key].

- ▶ [Home Screen Settings \(page 7-80\)](#)

• Customizing the home screen - changing the display order

You can change the order of the items in the home screen so that the items you use most frequently appear first.

To change the order of the items in the home screen, change in "Settings (administrator)" - [System Settings] → [Home Screen Settings] → [Condition Settings] → [Home Button].

- ▶ [Home Screen Settings \(page 7-80\)](#)

• Customizing the home screen - intuitive and easy-to-use design

A flat icon design is used to make the screen intuitive and easy to view. The toner level is always shown, eliminating the need to perform an action to check the toner level.



For the procedures for editing the home screen, see "U/I Customize Guide".

• High-contrast display (UD pattern)

The touch panel image can be set to high contrast.

Select [Pattern 5] in "Settings (administrator)" - [System Settings] → [Common Settings] → [Operation Settings] → [Condition Settings] → [MFP Display Pattern Setting].

- ▶ [Operation Settings \(page 7-122\)](#)

• Multi-language display

The language used in the touch panel can be changed to another language such as English or French.

Select the desired language in "Settings (administrator)" - [System Settings] → [Common Settings] → [Operation Settings] → [Condition Settings] → [Display Language Setting].

- ▶ [Operation Settings \(page 7-122\)](#)



Intuitive operation

- **Quick-view operation guide**

Touch the [Operation Guide] key in the home screen on the touch panel to display the operation guide. The operation guide provides simple explanations of how to use the machine.

- **Easy operation by storing programs**

The program function lets you store groups of settings for copying, fax, and other functions. By storing groups of settings that you frequently use, you can easily select those settings.

- ▶ [PROGRAMS \(page 2-140\)](#)
- ▶ [STORING FAX OPERATIONS \(PROGRAM\) \(page 4-72\)](#)
- ▶ [STORING SCAN OPERATIONS \(PROGRAM\) \(page 5-69\)](#)

- **Remote operation**

You can display the machine's touch panel on a computer on the same network to operate the machine from the computer. You can show how to use the machine on a computer, and people who have difficulty using the touch panel can operate the machine from a computer.

- ▶ [REMOTE OPERATION OF THE MACHINE \(page 1-59\)](#)

Easier operation at the machine

- **Job separator**

Even when a copy job is run while the machine is receiving a fax, you can use the job separator to output the jobs to separate trays so that the pages are not mixed together.

- ▶ [PART NAMES AND FUNCTION \(page 1-3\)](#)

- **Darkened output tray colour**

Output tray colours are darkened to make it easy to distinguish the tray to which a job has been output.

- **On right side of operation panel**

Located on the right side of the operation panel, this allows smooth removal of paper without interfering with the output tray.

- **Low Stand/550 Sheet Paper Drawer**

Easy to use even when sitting in a wheelchair or chair. Paper can be added or changed with ease.

Simple toner replacement

- **Automatic toner cartridge ejection**

When a toner cartridge runs out of toner, the cartridge is automatically ejected from the machine. This ensures that the wrong toner cartridge is not accidentally removed.

- ▶ [REPLACEMENT OF TONER CARTRIDGE \(page 1-157\)](#)

- **Prevention of toner cartridge mis-installation**

To prevent installation of a toner cartridge in the wrong location, each colour of toner cartridge can only be installed in its own location.

- ▶ [REPLACEMENT OF TONER CARTRIDGE \(page 1-157\)](#)

- **Toner box can be opened with one hand**

The box that contains a toner cartridge can be easily opened with one hand.



ITEMS RECORDED IN THE JOB LOG

The machine records the performed jobs in the job log.
The main information recorded in the job log is described below.



- To make it easy to total the usage counts of differently configured machines, the items recorded in the job log are fixed, regardless of what peripheral devices are installed or the objective of the recording.
- In some cases, job information may not be correctly recorded, such as when a power failure occurs during a job.

No.		Item name	Description
1	Main items	Job ID	The job ID is recorded. Job IDs appear in the log as consecutive numbers up to a maximum of 999999, after which the count resets to 1.
2		Account Job ID	The job ID used in the Sharp OSA is recorded.
3		Job Mode	The job mode type, such as copy or print is recorded.
4		Computer Name	The name of the computer that sent a print job is recorded.*
5		User Name	The user name when the user authentication function is used is recorded.
6		Login Name	The login name when the user authentication function is used is recorded.
7		Card ID	The card ID when it is used for an authentication process is recorded.
8		Number of Card Issuance	The number of times the card has been issued is written in an SSFC IC card is recorded.
9		Main Code	Main Code is recorded.
10		Sub Code	Sub Code is recorded.
11		Starting Date & Time	The date and time the job was started are recorded.
12		Completing Date & Time	The date and time the job was completed are recorded.
13		Black & White Total Count	For a print job, the total count is recorded. For a send job, the number of transmitted black & white pages is recorded. When a broadcast transmission is summarized, the total number of pages is recorded. For a scan to HDD job, the number of stored black & white pages is recorded.
14		Full Colour Total Count	The total number of pages in a print job that have been printed using a full colour is recorded.
15		Count according to size	Counts by original/paper size in colour mode and black & white mode are recorded.
16		Invalid Paper Count(Black & White)	The black & white invalid sheet count is recorded.
17		Invalid Paper Count(Colour)	The colour invalid sheet count is recorded.
18		Number of Reserved Sets	Number of specified sets or reserved destinations is recorded.
19		Number of Completed Sets	Number of completed sets or number of destinations to which transmission was successfully completed is recorded.



No.		Item name	Description
20	Main items	Number of Reserved Pages	Number of reserved original pages of a copy, print, scan job, or other job is recorded.
21		Number of Completed Pages	Number of completed pages of a set is recorded.
22		Result	The result of a job is recorded.
23		Error Cause	When an error occurs during a job, the cause of the error is recorded.
24	Print Job Related Item	Output	The output mode of a printed job is recorded.
25		Staple	The status of stapling is recorded.
26		Staple Count	The staple count is recorded.
27		Punch Count	The punch count is recorded.
28		Punch	The status of punching is recorded.
29		Fold	A job that uses the fold function is recorded.
30		Fold Count	Number of folded pages is recorded.
31		Saddle Fold	A job that uses the saddle fold function is recorded.
32		Saddle Fold Count	Number of saddle folded pages is recorded.
33		Printer Tone	The tone used for a print job is recorded.
34		Image Send Related Item	Address
35	Sender Name		Sender name of an image send job is recorded.
36	Sender Address		Sender address of an image send job is recorded.
37	Transmission Type		Transmission type of an image send job is recorded.
38	Administrative Serial Number		Administrative serial number of an image send job is recorded.
39	Broadcast number		Broadcast number of an image send job is recorded.
40	Entry order		Reservation order for broadcast transmission of an image send job is recorded. This is used to link communication and printing when recording multi polling jobs.
41	File Format		File format of an image send job or scan to HDD job is recorded.
42	Sign		Records whether or not an electronic signature is used in e-mail transmission.
43	Encrypt		Records whether or not encryption is used for e-mail transmission.
44	Compression Mode/Compression Ratio		Compression mode and compression ratio of the file of an image send job or scan to HDD job is recorded.
45	Communication Time		The communication time of image send jobs is recorded.
46	Fax No.		The stored sender's number is recorded.
47	Document Filing Related Item		Document Filing
48		Storing Mode	Document filing storing mode is recorded.



No.		Item name	Description
49	Common Functionality	Colour Setting	Colour mode selected by user is recorded.
50		Special Modes	Special modes selected when the job was executed is recorded.
51		File Name	The stored file name is recorded.*
52		Data Size [KB]	The size of a file is recorded.
53	Detailed Items	Original Size	Size of scanned original is recorded. For a document filing print job, the paper size of the file is recorded.
54		Original Type	Original type (text, printed photo, etc.) set in the exposure settings screen is recorded.
55		Original Count	Number of scanned original sheets is recorded.
56		Paper Size	For a print job, the paper size is recorded. For a send job, the transmitted paper size is recorded. For a Scan to HDD job, the paper size of the stored file is recorded.
57		Paper Type	The paper type used for printing is recorded.
58		Paper Property	The paper property specified in "Paper Type" is recorded.
59		Duplex Setup	The duplex setting is recorded.
60		Resolution	The scanning resolution is recorded.
61		Machine Item	Model Name
62	Unit Serial Number		The serial number of the machine is recorded.
63	Name		The name of the machine that is set in the Web pages is recorded.
64	Machine Location		The installation location of the machine that is set in the Web pages is recorded.
65	Machine ID		Record the Machine ID entered by the service technician.

* In some environments this is not recorded.



LOADING PAPER

IMPORTANT POINTS ABOUT PAPER

NAMES AND LOCATIONS OF TRAYS

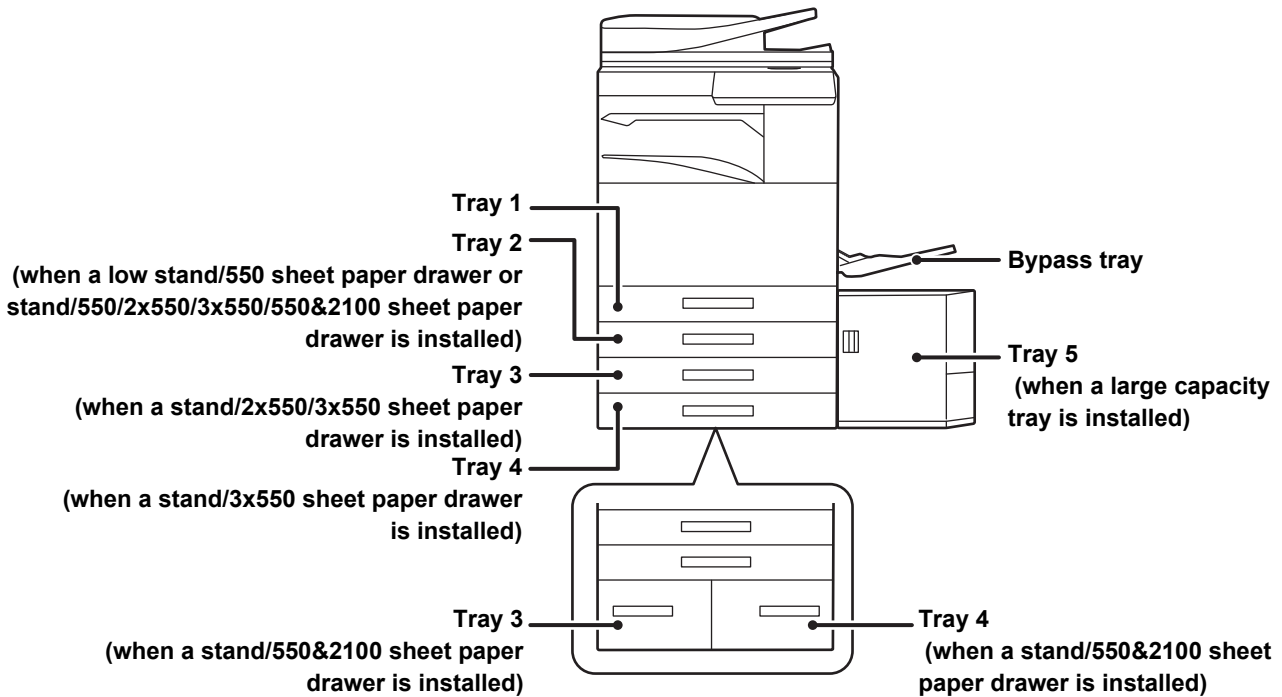

THE DEFINITION OF "R" IN PAPER SIZE

To indicate the landscape setting, "R" is added to the end of the name of a paper size enabled for both landscape and portrait settings.

Paper that can be set either in the portrait or landscape orientation		Paper that can only be set in the landscape orientation
A4, B5, 8-1/2" x 11"		SRA3, A3W, A3, SRA4, B4, 12" x 18", 11" x 17", 8-1/2" x 14", 8-1/2" x 13"
Paper set in the landscape orientation	Paper set in the portrait orientation	Can be placed only in the landscape orientation
<div style="border: 1px solid black; padding: 5px; width: fit-content;"> A4R (8-1/2" x 11"R) </div>	<div style="border: 1px solid black; padding: 5px; width: fit-content;"> A4 (8-1/2" x 11") </div>	<div style="border: 1px solid black; padding: 5px; width: fit-content;"> A3 (11" x 17") </div>



APPLICABLE PAPER TYPES

This section describes paper types that can be used and those that cannot be used. All types of paper other than plain paper are referred to as special media.



- Various types of paper are commercially available, some of which cannot be used on the machine. Before using any paper, consult the dealer or nearest authorised service representative.
- The image quality and toner fusibility of paper may change due to ambient conditions, operating conditions, and paper characteristics, resulting in image quality inferior to that of Sharp standard paper. Before using any paper, consult the dealer or nearest authorised service representative.
- The use of non-recommended or non-usable paper may result in skewed feeding, misfeeds, poor toner fusing (the toner does not adhere to the paper well and can be rubbed off), or machine failure.
- The use of non-recommended paper may result in misfeeds or poor image quality. Before using non-recommended paper, check whether printing can be performed properly.

Useable paper

Specifications of plain paper, heavy paper and thin paper

Plain Paper*		<ul style="list-style-type: none"> • Sharp standard paper: 80 g/m² (20 lbs) For paper specifications, see the specifications in the "Start Guide". • Non-Sharp standard plain paper: 60 g/m² to 105 g/m² (16 lbs to 28 lbs)
Heavy paper	Heavy paper 1	106 g/m ² to 176 g/m ² (28 lbs. bond to 65 lbs. cover)
	Heavy paper 2	177 g/m ² to 220 g/m ² (65 lbs. cover to 80 lbs. cover)
	Heavy paper 3	221 g/m ² to 256 g/m ² (80 lbs. cover to 140 lbs. index)
	Heavy paper 4	257 g/m ² to 300 g/m ² (140 lbs. index to 110 lbs. cover)
Thin paper		55 g/m ² to 59 g/m ² (13 lbs to 16 lbs)

* Set a suitable paper weight in "Settings (administrator)" → [System Settings] → [Common Settings] → [Device Control] → [Plain Paper Weight Settings]. This can only be set on the machine's operation panel.



- Recycled paper, coloured paper and pre-punched paper must meet the same specifications as plain paper. Before using any paper, consult the dealer or nearest authorised service representative.
- If the paper that was output is significantly curled, remove the paper from the cassette, turn the paper over so it is face down, and resume use.

Specifications of paper that can be used for two-sided printing

Paper Type	Plain, Recycled, Colour, Letter Head, Pre-Printed, Punched, Heavy Paper (106 g/m ² (28 lbs. bond) to 256 g/m ² (140 lbs. index))
Paper Size	SRA3, A3W, A3, B4, SRA4, A4, A4R, B5, B5R, A5R, 12" x 18", 11" x 17", 8-1/2" x 14", 8-1/2" x 13-1/2", 8-1/2" x 13-2/5", 8-1/2" x 13", 8-1/2" x 11", 8-1/2" x 11"R, 5-1/2" x 8-1/2"R



Types of paper that can be set in each tray



- For detailed information on the sizes and types of paper that can be loaded into each tray of the machine, see "SPECIFICATIONS" in the "Start Guide" and "[Paper Tray Settings \(page 7-119\)](#)".
- Recycled paper, coloured paper and pre-punched paper must meet the same specifications as plain paper. Before using any paper, consult the dealer or nearest authorised service representative.

	Tray 1	Tray 2* ¹ Tray 3* ² Tray 4* ³	Tray 3 Tray 4* ⁴	Tray 5* ⁵	Bypass tray
Plain Paper	Permitted	Permitted	Permitted	Permitted	Permitted
Heavy Paper 1* ⁶	Permitted	Permitted	-	Permitted	Permitted
Heavy Paper 2* ⁶	Permitted	Permitted	-	Permitted	Permitted
Heavy Paper 3* ⁶	Permitted	Permitted	-	-	Permitted
Heavy Paper 4* ⁶	Permitted	Permitted	-	-	Permitted
Embossed	-	-	-	-	Permitted
Thin Paper	-	-	-	-	Permitted
Pre-Printed	Permitted	Permitted	Permitted	Permitted	Permitted
Recycle Paper	Permitted	Permitted	Permitted	Permitted	Permitted
Letter Head	Permitted	Permitted	Permitted	Permitted	Permitted
Pre-Punched	Permitted	Permitted	Permitted	Permitted	Permitted
Colour	Permitted	Permitted	Permitted	Permitted	Permitted
Labels	-	-	-	-	Permitted
Glossy Paper	-	-	-	-	Permitted
Transparency	-	-	-	-	Permitted
Tab Paper	-	-	-	-	Permitted
Envelope	-	-	-	-	Permitted

*1 when a low stand/550 sheet paper drawer or stand/550/2x550/3x550/550&2100 sheet paper drawer is installed

*2 when a stand/2x550/3x550 sheet paper drawer is installed

*3 when a stand/3x550 sheet paper drawer is installed

*4 when a stand/550&2100 sheet paper drawer is installed

*5 when a large capacity tray is installed

*6 "Heavy Paper 1" is heavy paper up to 176 g/m² (65 lbs. cover), "Heavy Paper 2" is heavy paper up to 220 g/m² (80 lbs. cover), "Heavy Paper 3" is heavy paper up to 256 g/m² (140 lbs. index), and "Heavy Paper 4" is heavy paper up to 300 g/m² (110 lbs. cover).



Setting orientation of the print side

The setting orientation varies for the print side of paper, depending on the tray used. For "Letter Head" and "Pre-Printed", set the paper in the reverse orientation.

Place with the print side facing the direction indicated below.

Tray	In normal status	With letter head or pre-printed paper set
Trays 1 - 4	Facing up	Facing down
Bypass, Tray 5	Facing down	Facing up



When [Disabling of Duplex] is set for "Letter Head" or "Pre-Printed", set the print side in the same orientation as for the ordinary operation.



To set [Disabling of Duplex]:

In "Settings (administrator)", select [System Settings] → [Common Settings] → [Device Control] → [Disabling of Duplex].

Paper that cannot be used

- Special media for an ink jet printer (fine paper, glossy paper, glossy film, etc.)
- Carbon paper or thermal paper
- Pasted paper
- Paper with clips
- Paper with fold marks
- Torn paper
- Oil-feed transparency film
- Thin paper less than 55 g/m² (15 lbs)
- Heavy paper as thick as 300 g/m² (110 lbs. cover) over
- Irregularly shaped paper
- Stapled paper
- Damp paper
- Curled paper
- Paper whose print side or reverse side has been already printed on by another printer or multifunction device.
- Paper with a wave-like pattern due to moisture absorption
- Paper with creases
- Paper with dust

Non-recommended paper

- Iron-on transfer paper
- Perforated paper



TRAY 1 - 4 (when a low stand/550 sheet paper drawer or stand/550/2x550/3x550/550&2100 sheet paper drawer is installed)

A maximum of 550 sheets of paper from size A5R to SRA3 (5-1/2" x 8-1/2"R to 12" x 18") can be loaded into trays 1 to 4.



If you loaded paper of a different type or size from the paper previously loaded, be sure to check the settings in "Settings (administrator)". Incorrect setting affects automatic paper selection action. It may cause print failure, printing on paper of a wrong size or type or paper misfeeds.



Do not place heavy objects on the tray or press down on the tray.



To check the type and size of paper:

[Tray Settings] in the home screen or in "Settings", select [Status] → [Machine Identification] → [Paper Input Tray Status] → [Paper Tray Settings].

To set the type and size of paper:

Set this in [Tray Settings] in the home screen or in "Settings" - [System Settings]→[Common Settings]→[Paper Settings]→[Paper Tray Settings].

1

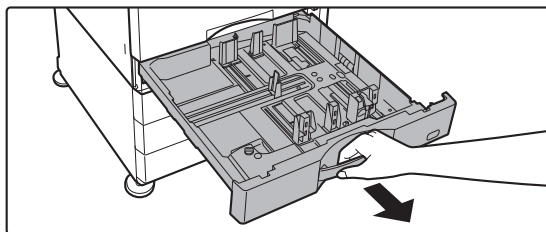

Pull out the paper tray.

Gently pull the tray out until it stops.

To load paper, go to step 3. To load a different size of paper, go to the next step.



Pull the handle until the lock is released.

2

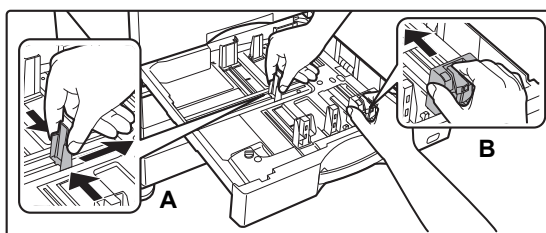

Adjust guide plates A and B to match the longitudinal and transversal dimensions of the paper to be loaded.

The guide plates A and B are slidable. Squeeze the separator plate lever and slide to the desired paper size. Adjust to the non-standard paper size so that the paper will not be too loose or too tight.

3

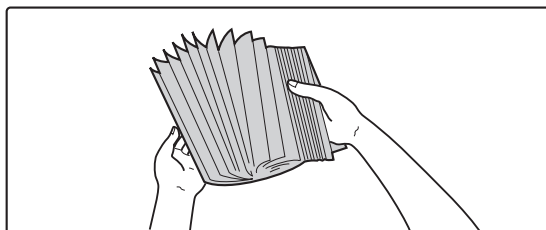

Fan the paper.

Fan the paper well before loading it. If the paper is not fanned, multiple sheets may feed at once and cause a misfeed.



4

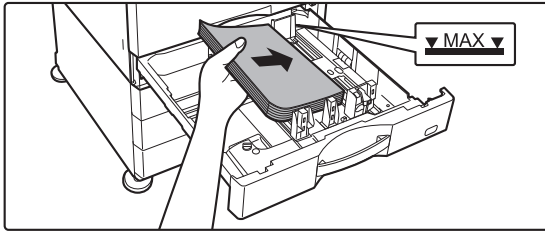

Insert the paper into the tray.

Load the paper with the print side facing up. The stack must not be higher than the indicator line (maximum of 550 sheets).

5

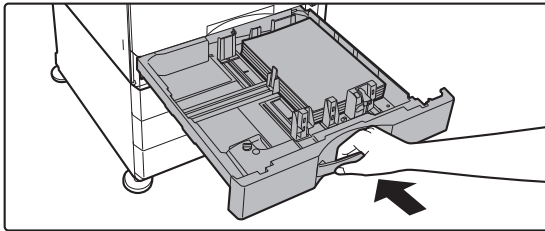

Gently push the paper tray into the machine.

Push the tray firmly all the way into the machine slowly. Forcefully inserting the paper may cause skewed feeding and paper misfeeds.

Loading paper in the SRA3

When loading paper in the SRA3, follow the steps below to move the control plate auxiliary block.

1

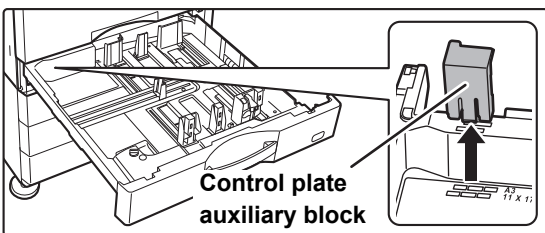

Remove the control plate auxiliary block.

2

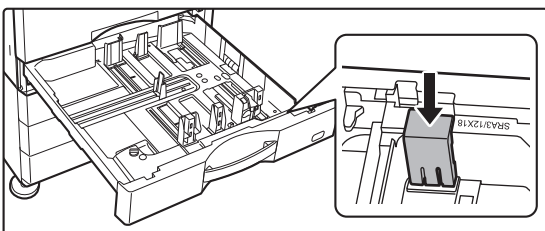

Attach the control plate auxiliary block that was removed in step 1.



Loading paper in the 11" x 17" or A3

When loading paper in the 11" x 17" or A3, follow the steps below to move the control plate auxiliary block.

1

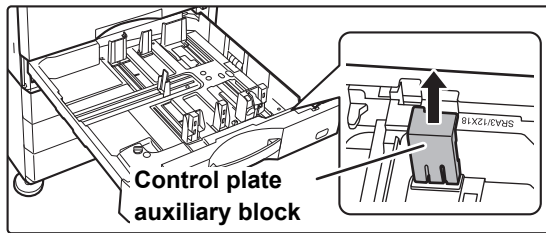

Remove the control plate auxiliary block.

2

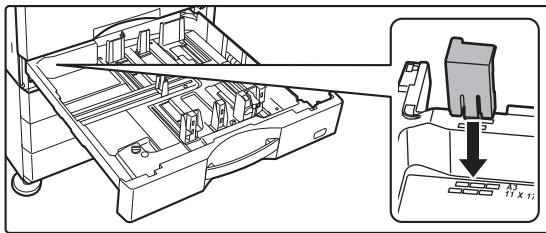

Attach the control plate auxiliary block that was removed in step 1.



TRAY 3 - 4 (when a stand/550&2100 sheet paper drawer is installed)

A maximum of 1200 sheets of A4 (8-1/2" × 11") paper can be loaded into tray 3 (left).

A maximum of 900 sheets of A4 (8-1/2" × 11") and B5 paper can be loaded into tray 4 (right).



If you loaded paper of a different type or size from the paper previously loaded, be sure to check the settings in "Settings". An incorrect setting may cause print failure, printing on paper of an incorrect size, or type or paper misfeeds.



To check the type and size of paper:

In "Settings", select [System Settings] → [Common Settings] → [Paper Settings] → [Paper Tray Settings].



Do not place heavy objects on the tray or press down on the tray.

1

Tray 3

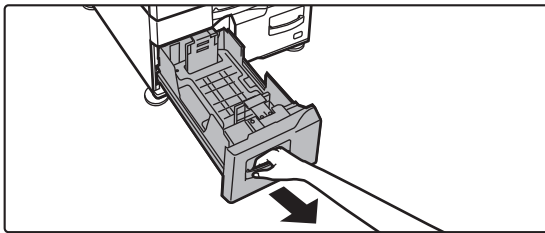

Pull out the paper tray.

Gently pull the tray out until it stops.

Tray 4

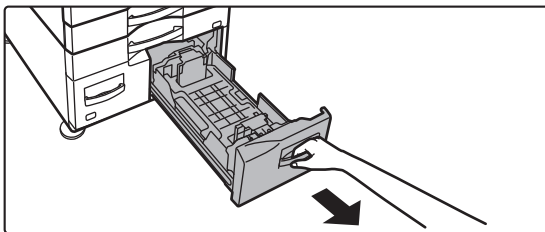

Pull the handle until the lock is released.

2

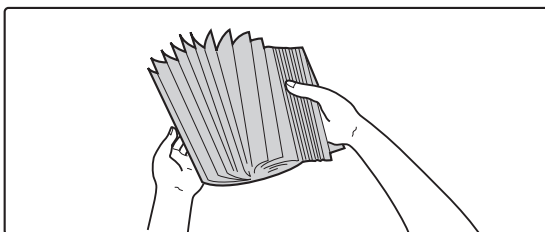

Fan the paper.

Fan the paper well before loading it. If the paper is not fanned, multiple sheets may feed at once and cause a misfeed.



3

Tray 3

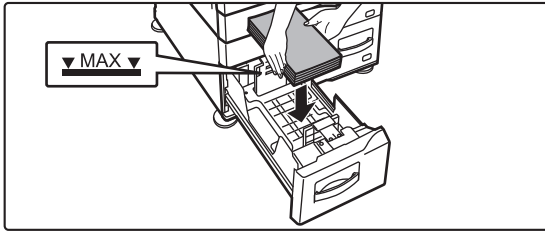

Place paper into the tray.

Load the paper with the print side facing up. The stack must not be higher than the indicator line (maximum of 1200 sheets for tray 3, or maximum of 900 sheets for tray 4).

Tray 4

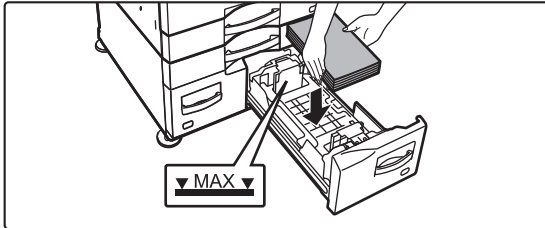

4

Tray 3

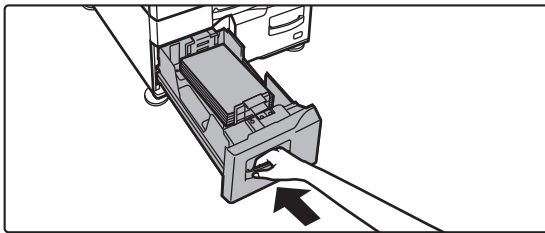

Gently push the paper tray into the machine.

Push the tray firmly all the way into the machine slowly.

Tray 4

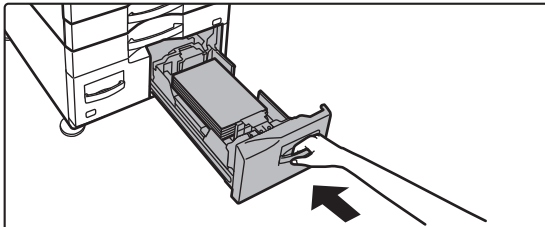



LOADING PAPER IN THE LARGE-CAPACITY TRAY (when a large capacity tray is installed)

The large capacity tray is used for very large print jobs that cannot be handled with a regular tray. Up to 3000 sheets of A4 or B5 paper (80g/m²) can be loaded in the tray.

If you find it necessary to change the paper size, consult the dealer or nearest authorised service representative.



If you loaded paper of a different type from the paper previously loaded, be sure to check the settings in "Settings".



To check the paper type loaded in the tray

Check in "Settings" - [System Settings] → [Common Settings] → [Paper Settings] → [Paper Tray Settings].



When the tray is open, do not place heavy objects on the tray or press down on the tray.

1

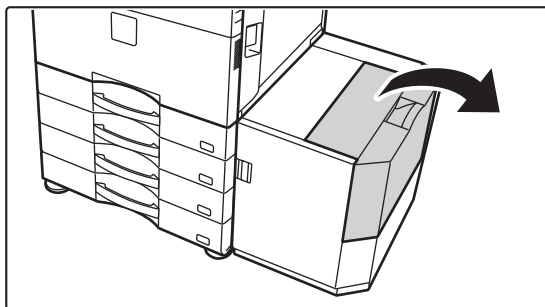

Open the top cover.

2

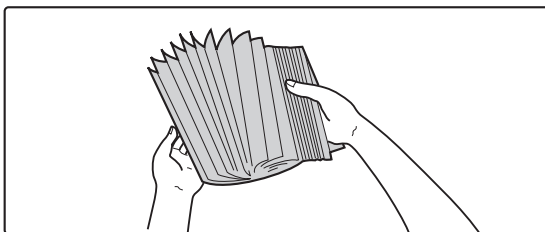

Fan the paper.

Fan the paper well before loading it. If the paper is not fanned, multiple sheets may feed at once and cause a misfeed.



3

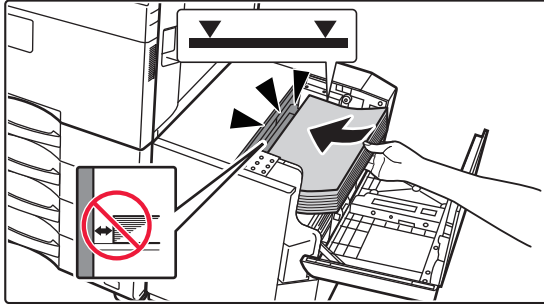

Place the paper in the paper feed table.

Insert the paper into the tray until it stops.
Place the paper print side down. The stack should not exceed the indicator line (maximum 3000 sheets).



When adding paper, take care that previously loaded paper does not shift out of place. This may cause misfeeds and folding back of the front edge of the loaded paper.

4

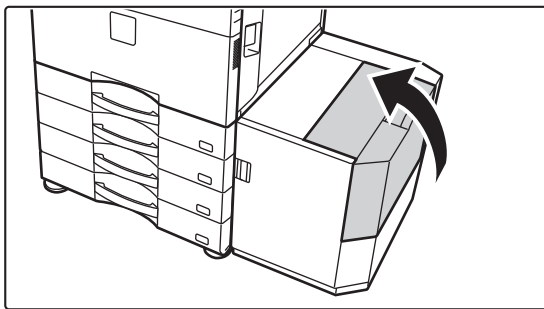

Gently close the cover.



LOADING PAPER INTO THE BYPASS TRAY

Use the bypass tray for printing on plain paper, envelopes, label sheets, tab paper, and other special media.

Up to 100 sheets of paper can be loaded (Heavy paper weighing between 106 g/m² and 256 g/m² (28 lbs. bond and 140 lbs. index): 40 sheets, heavy paper weighing between 257 g/m² and 300 g/m² (140 lbs. index and 110 lbs. cover) and envelope: 20 sheets) for continuous printing, just like operation using other trays.



- When using plain paper other than Sharp standard paper or special media other than SHARP-recommended transparency film, glossy paper, or when printing on the reverse side of paper that has been printed on one side, load paper one sheet at a time. Loading more than one sheet at a time will cause misfeeds.
- Before loading paper, straighten any curling in the paper.
- When adding paper, remove any paper remaining in the bypass tray, combine it with the paper to be added, and reload as a single stack. If paper is added without removing the remaining paper, a misfeed may result. Loading more sheets than the specified number of sheets or the limit may cause paper misfeeds.

How to place the original

Load paper up to A5 (7-1/4" x 10-1/2") size in landscape orientation.

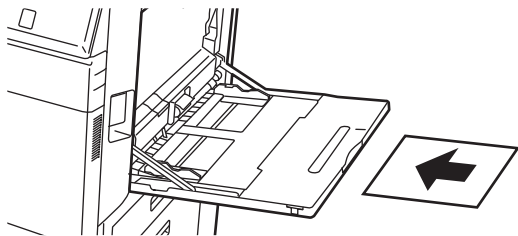

Loading tab paper

To print on tab paper, load tab paper into the bypass tray with the print side facing down.

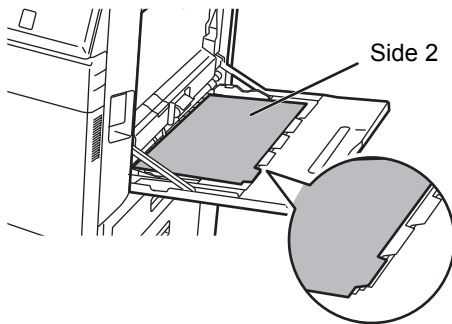

- Use only tab paper that is made of paper. Tab paper made of a material other than paper (film, etc.) cannot be used.
- To print on the tabs of tab paper:
In copy mode, use [Tab Copy] in "Others". In print mode, use the tab print function.



Inserting transparency film



- Use SHARP-recommended transparency film.
- When loading multiple sheets of transparency film into the bypass tray, fan the sheets several times before loading.
- When printing on transparency film, remove each sheet as it is printed and output from the machine. Allowing sheets to stack in the output tray may result in curling.

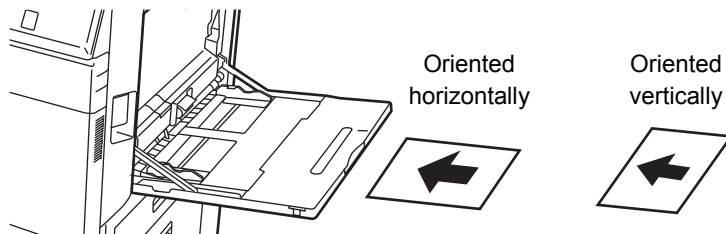

Loading envelopes

When inserting envelopes in the bypass tray, place them aligned to the left side in the orientation shown below. Only the front side of envelopes can be printed or copied on. Place the front side facing down. Fold the flap and make a sharp crease at the fold.

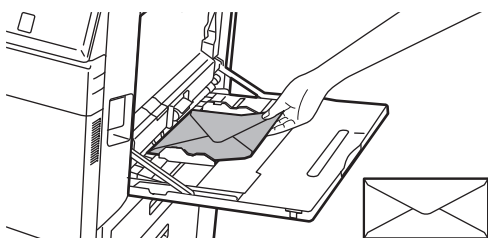



Important points when using envelopes

- Do not print on both sides of an envelope. This may result in misfeeds or poor print quality.
- Restrictions apply to some types of envelopes. For more information, consult a qualified service technician.
- Some operating environments may cause creasing, smudging, misfeeds, poor toner fusing, or machine failure.
- Fold the flap of the envelope and make a sharp crease at the fold. A misfeed may occur if the flap is up.
- Do not use the following envelopes:
 - Those with a metal piece, a plastic hook or a ribbon hook
 - Those with a string for closing
 - Those with a window
 - Those with a lining
 - Those with an uneven surface, finished with titling or emboss
 - Duplex envelopes or those with adhesive or other synthetic material for sealing
 - Hand-made envelopes
 - Those containing air inside
 - Those damaged with a crease, fold mark or tear

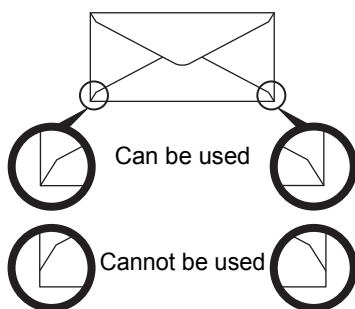

- Envelopes with the corner gluing position on the back not aligned with the corner edge should not be used as it may cause creasing.
- Print quality is not guaranteed in the area 10 mm (13/32") around the edges of the envelope.
- Print quality is not guaranteed on parts of envelopes where there is a large step-like change of thickness, such as on four-layer parts or parts less than three layers.
- Print quality is not guaranteed on envelopes having peel off flaps for sealing the envelopes.

Important points when using embossed paper/label sheets

- The effect of asperity surfaces of embossed paper may affect the print quality depending on the type of embossed paper.
For more information, consult the dealer or nearest authorised service representative.
- Some labels may have to be loaded into the bypass tray in the specified orientation. Follow such instructions.
If a form is already printed on the labels, and the print images and the preprinted form do not line up, adjust the application or printer driver settings to rotate the print images.
- Do not use the following types of label sheets.
 - Label sheets without an adhesive copy or label copy
 - Label sheets with adhesive exposed
 - Label sheets with a specified feeding direction that is not supported by the machine
 - A label sheet that has already been fed or has some labels removed
 - Label sheets consisting of multiple sheets
 - Label sheets that do not support laser printing
 - Label sheets that cannot withstand heat
 - Label sheets that have perforations in the backing paper
 - Label sheets with slits in the backing paper
 - Non-standard label sheets
 - Label sheets with adhesive that has deteriorated due to prolonged storage or otherwise
 - Label sheets with cutouts that expose the backing paper
 - Curled or otherwise deformed label sheets
 - Torn or creased label sheets



1

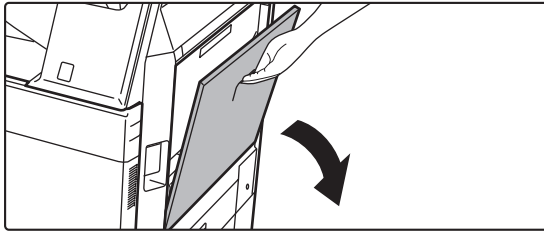

Open the bypass tray.

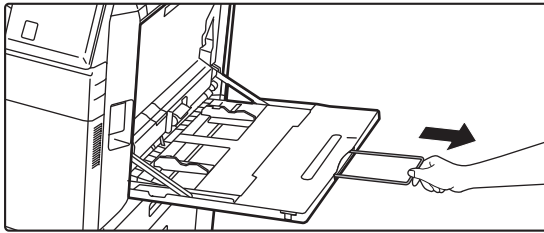

When loading paper larger than 8-1/2" x 11"R or A4R, pull out the extension guide.
Pull the extension guide all the way out.



Do not place heavy objects on the bypass tray or press down on the tray.

2

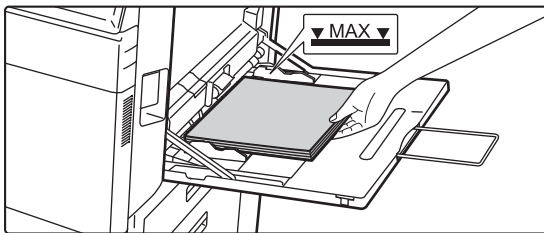

Load the paper with the print side facing down.

Insert the paper along the bypass tray guides all the way into the bypass tray until it stops slowly. Inserting the paper with excessive force may cause the leading edge to fold back. Inserting the paper too loosely may cause skewed feeding or misfeeds.

The paper must not exceed the maximum number of sheets and must not be higher than the indicator line.

3

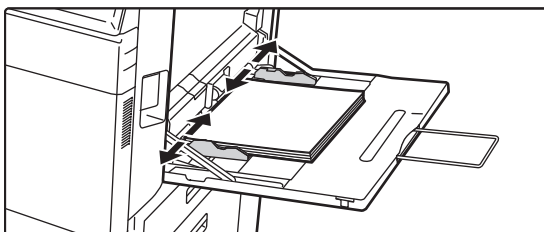

Set the bypass tray guides correctly to the width of the paper.

Adjust the bypass tray guides so that they slightly contact the loaded paper.



For "Letter Head" and "Pre-Printed", set the paper with the print side up. However, when [Disabling of Duplex] is enabled, set the print side in the same orientation as in the regular mode (facing down).



- Do not forcefully push in paper that you are loading. This may cause misfeeds.
- If the bypass tray guides are set wider than the paper, move the bypass tray guides in until they correctly fit the width of the paper. If the bypass guides are set too wide, the paper may skew or be creased.



To display the paper tray settings when paper is detected in the bypass tray

In "Settings", select [System Settings] → [Common Settings] → [Paper Settings] → [Paper Tray Settings] → [Display Paper Tray Settings when bypass tray detects paper.].



HOW TO PLACE THE LONG PAPER GUIDE

The steps for attaching the optional long paper feeding tray to the bypass tray are explained below.

1

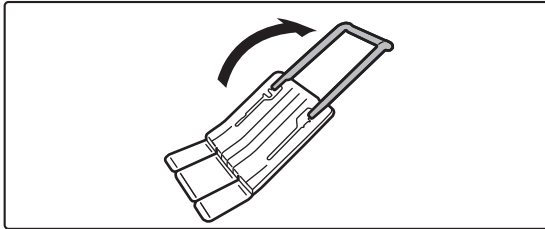

Extend the auxiliary guide of the long paper feeding tray.

2

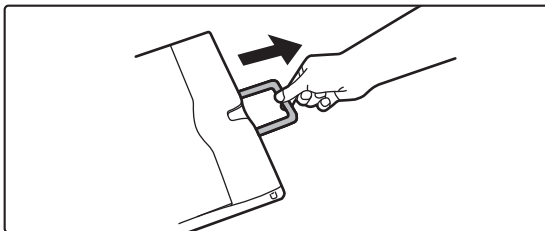

Pull out the extension guide of the bypass tray.

3

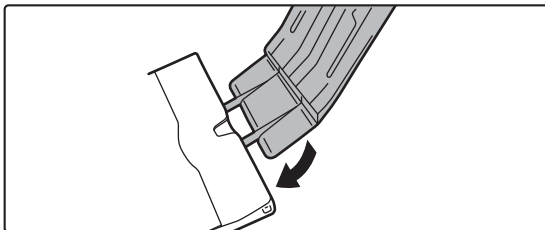

Attach the long paper feeding tray onto the extension guide of the bypass tray.

4

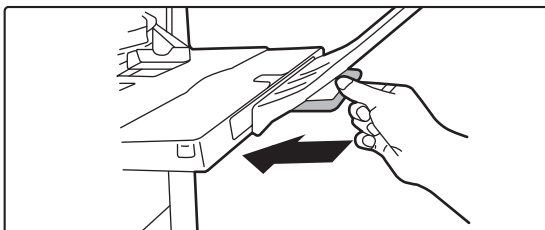

Replace the extension guide of the bypass tray.



HOW TO PLACE THE ORIGINAL

SELECTING A PROCEDURE FOR PLACING THE ORIGINAL DEPENDING ON THE TYPE AND STATUS OF THE ORIGINAL

Place the original in the automatic document feeder. Depending the type and status of the original, use the document glass. Follow the instructions to select the method for placing the original.

To place it in the automatic document feeder, see "[AUTOMATIC DOCUMENT FEEDER \(page 1-84\)](#)".



AUTOMATIC DOCUMENT FEEDER

This section explains how to place originals in the automatic document feeder.



- Place originals of different sizes together, if needed, in the automatic document feeder. In that case, use the "Others" function in each mode to set [Mixed Size Original]. An original cannot be detected if all pages are of the same size but some of them are set in a different orientation.

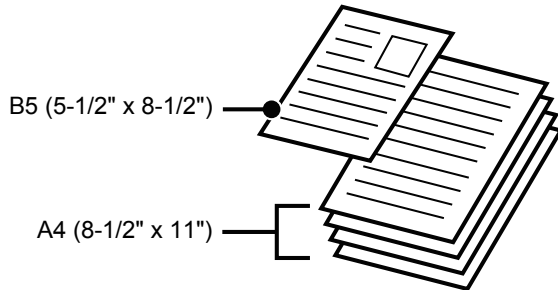

- Before inserting originals into the document feeder tray, be sure to remove any staples or paper clips.
- If originals have damp spots due to correction fluid, ink or paste up glue, wait until the originals are dry before making copies. Otherwise the interior of the machine or the document glass may be soiled.
- Do not use the following originals. Incorrect original size detection, original misfeeds, and smudges may result. Transparency film or other transparent material for backup copy, tracing paper, carbon paper, thermal paper or originals printed with thermal transfer ink ribbon should not be fed through the document feeder. Originals to be fed through the feeder should not be damaged, crumpled, folded, loosely pasted together, or have cut-out holes. Originals with multiple punched holes other than two-hole or three-hole punched paper may not feed correctly.
- When using originals with two or three holes, place them so that the punched edge is at a position away from the feed slot of the document feeder tray. Specify the orientation of the original using [Original].

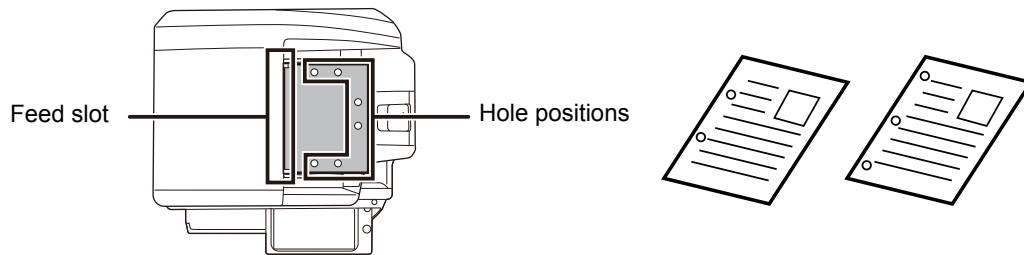

- For a thin original (35 g/m² - 49 g/m² (9 lbs. to 14 lbs.)), use [Slow Scan Mode] in the "Others". For this type, 2-sided scanning is disabled.





Allowed original sizes

Minimum original size	Maximum original size
<p>Standard size (Minimum size that can be automatically detected) 148 mm (longitudinal) × 210 mm, or A5 5-1/2" (longitudinal) × 8-1/2" (transversal)</p> <p>Non-standard size (Minimum size that can be specified manually) 131 mm (longitudinal) × 140 mm (transversal) 5-1/8" (longitudinal) × 5-1/2" (transversal)</p>	<p>Standard size (Maximum size that can be automatically detected) 297 mm (longitudinal) × 420 mm (transversal) or A3 11" (longitudinal) × 17" (transversal) A3W (12" × 18") cannot be used.</p> <p>Non-standard size (Maximum size that can be specified manually) Copy mode: 297 mm (longitudinal) × 432 mm (transversal) 11-5/8" (longitudinal) × 17" (transversal) image send mode: 297 mm (longitudinal) × 1000 mm (transversal) 11" (longitudinal) × 39-3/8" (transversal)</p>

When the original is a non-standard size, see the appropriate explanation below for the mode you are using.

- COPIER: "[SELECTING THE ORIENTATION AND SIZE OF THE ORIGINAL \(page 2-33\)](#)"
- FAX: "[SPECIFYING THE ORIGINAL SCAN SIZE USING NUMERIC VALUES \(page 4-48\)](#)"
- IMAGE SEND: "[SPECIFYING THE ORIGINAL SCAN SIZE USING NUMERIC VALUES \(page 5-51\)](#)"

Allowed original weights

MX-2630N/MX-3050V/MX-3060V/ MX-3550V/MX-3560V/MX-4050V/ MX-4060V/MX-5050V/MX-6050V	1-sided scanning: 35 to 128 g/m ² (9 to 32 lbs Bond) 2-sided scanning: 50 to 105 g/m ² (13 to 28 lbs Bond)
MX-3070V/MX-3570V/MX-4070V/ MX-5070V/MX-6070V	1-sided scanning: 35 to 128 g/m ² (9 to 32 lbs Bond) 2-sided scanning: 50 to 128 g/m ² (13 to 32 lbs Bond)

To scan originals from 35 to 49 g/m² (9 to 13- lbs Bond), use "Slow Scan Mode" in the "Others" function. Scanning without using "Slow Scan Mode" may result in original misfeeds.

When "Slow Scan Mode" is selected, automatic 2-sided scanning is not possible.

1

Make sure that there is no original on the document glass.

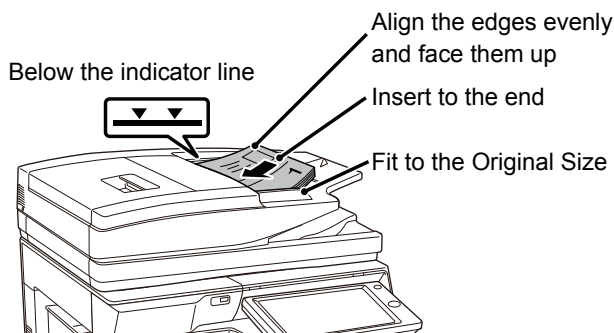
2

Place the original.

MX-2630N/MX-3050V/MX-3060V/MX-3550V/MX-3560V/
MX-4050V/MX-4060V/MX-5050V/MX-6050V: Up to 100
sheets can be inserted.

MX-3070V/MX-3570V/MX-4070V/MX-5070V/MX-6070V: Up
to 150 sheets can be inserted.

After scanning is finished on the automatic document feeder,
remove originals from the original exit tray.



DOCUMENT GLASS

This section describes the steps for setting the original on the document glass.



- Close the automatic document feeder slowly. Abruptly closing the automatic document feeder may damage it.
- Take care that your fingers are not pinched when closing the automatic document feeder.

Allowed original sizes

Maximum original size

Standard size

297 mm (longitudinal) x 420 mm (transversal) or A3
11" (longitudinal) x 17" (transversal)

Non-standard size

297 mm (longitudinal) x 432 mm (transversal)
11-5/8" (longitudinal) x 17" (transversal)

When the original is a non-standard size, see the appropriate explanation below for the mode you are using.

- ▶ COPIER: "[SELECTING THE ORIENTATION AND SIZE OF THE ORIGINAL \(page 2-33\)](#)"
- ▶ FAX: "[SPECIFYING THE ORIGINAL SCAN SIZE USING NUMERIC VALUES \(page 4-48\)](#)"
- ▶ IMAGE SEND: "[SPECIFYING THE ORIGINAL SCAN SIZE USING NUMERIC VALUES \(page 5-51\)](#)"

1

Open the automatic document feeder.

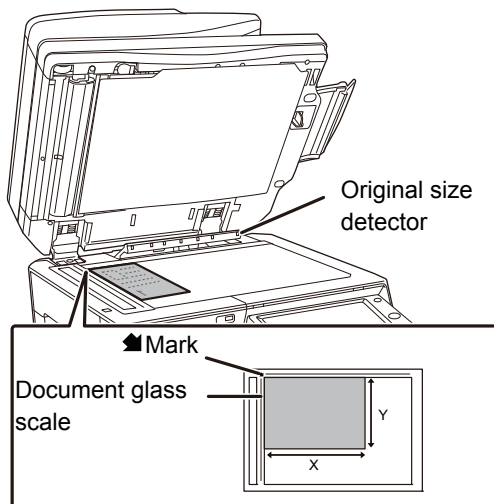
2

Load the paper with the print side facing down.

Place the original face down and align the top left corner of the original with back left (at the tip of the mark ) of the document glass.



Do not place any objects under the original size detector.

Closing the automatic document feeder with an object underneath may damage the original size detector or disable correct detection of the original size.



When placing a non-standard size original on the document glass, the size can be detected easily if a blank sheet of A4 (8-1/2" x 11"), B5 (5-1/2" x 8-1/2"), or other standard size paper is placed on top of the original.



3

Close the automatic document feeder.

After placing the original, close the automatic document feeder. If the unit is left open, parts outside of the original will be copied in black, causing excessive use of toner.



- When closing, open the automatic document feeder all the way and then close it.
- If originals have damp spots due to correction fluid, ink or paste up glue, wait until the originals are dry before making copies. Otherwise the interior of the machine or the document glass may be soiled.



STOPPING/DELETING A JOB, PRIORITY PROCESSING AND CHECKING THE STATUS

TYPES OF JOB STATUS SCREENS

When you tap the job status display, the job status screen appears. Tap it again to return to the previous mode. The job status screen is divided into the following four tabs, enabling you to select a job list by tapping a desired tab.

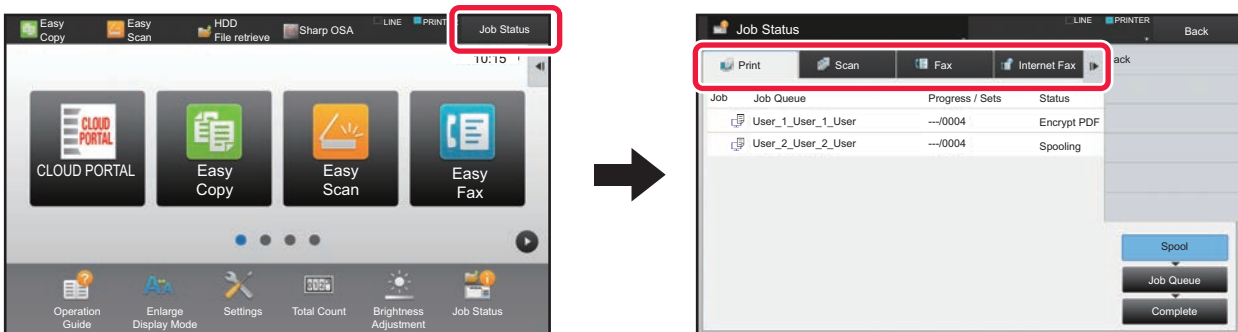

- **Print**
Lists print jobs such as copying, printing from a PC, USB direct print, and printing for faxed or other received data.
- **Scan**
Lists send jobs of converted images for e-mail messages and FTP/Desktop send jobs.
- **Fax**
Lists fax send jobs using a telephone line.
- **Internet Fax**
Lists fax send jobs using internet.



The background of the job status display changes as follows:

- Green: Job in progress
- Yellow: Warming up/waiting
- Red: Waiting for error clearing



To prohibit the display and changing of job information of other users when user authentication is enabled

Select "Settings (administrator)" → [User Control] → [Default Settings] → [Include Job Status in user authentication] → [Disable display/change of other users' information in the job status] check box to .

On each tab, jobs are classified into three groups.

Jobs move among the lists according to the processing status, from [Spool], [Job Queue] and [Complete], in that order. To switch the job list display to the display by processing status, tap the [Spool], [Job Queue] or [Complete] key as desired.

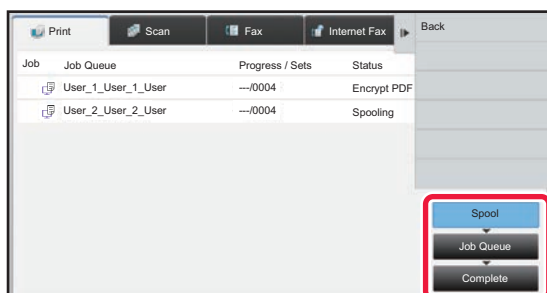



- Spool list (Only displayed when a print-from computer job is received)
Lists print jobs up to the transfer to the machine from a computer. The jobs move to the Job Queue list after the transfer is completed.
If you printed an encrypted PDF file by direct print, enter the password from here to print the file.
► [PRINTING AN ENCRYPTED PDF FILE \(page 3-88\)](#)
- Job Queue list
Lists jobs in progress and in the queue for copying, printing from a computer and printing of received fax. This list also displays jobs in progress and in the queue for sending fax data or sending image data converted on the machine. The jobs move to the Complete list after printing or sending is completed.
- Complete list
Lists jobs through with copying, printing or sending.



STOPPING/DELETING A JOB IN PROGRESS OR RESERVED

1

Tap the job status display and tap the tab for the job that you wish to stop or delete.

2

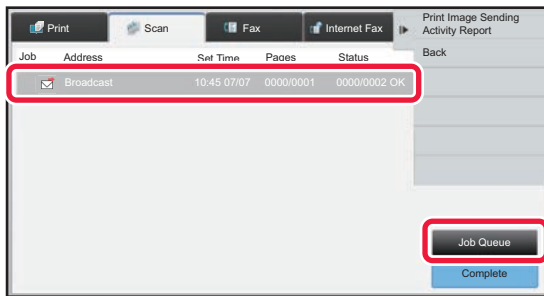

Tap the [Job Queue] key.



When you wish to stop a print job being sent from the computer, tap the [Spool] key.

3

Tap the job that you wish to stop or delete, and then tap [Stop/Delete] on the action panel.

When a screen appears that allows you to confirm that you do want to stop the job, tap the [Cancel] key.



If the machine runs out of paper during a copy or print job, you can cancel the job from the job status screen. To delete more than one job, operate the check box for [Enter Plural Selection Mode] on the action panel so that it looks like .



- Printing of a received fax or Internet fax cannot be stopped.
- A job set for transfer in "[FORWARDING RECEIVED DATA TO PRESET DESTINATIONS \(INBOUND ROUTING SETTINGS\) \(page 4-64\)](#)" cannot be cancelled.



PRIORITY PROCESSING OF A RESERVED JOB

This function gives priority to processing of copied, faxed or image send jobs arising later to jobs already in a queue for printing or sending.



Priority processing operation varies, as follows, depending on the job type.

- Job on the print tab
The job currently in progress is suspended to let the priority job make interruption.
- Job on the scanner/fax/Internet fax tab
The priority job is moved directly under the job currently in progress.

1

Tap the job status display and tap the job for priority processing.

2

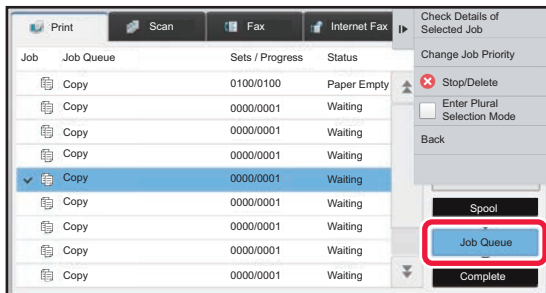

Tap the [Job Queue] key.

3

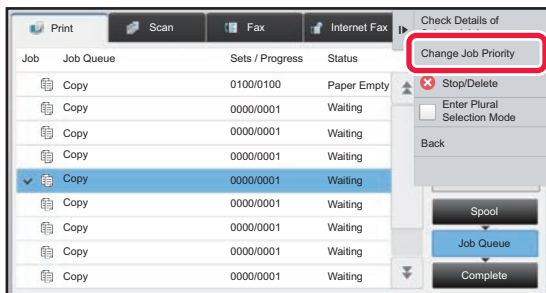





Tap the job for priority processing and then tap [Change Job Priority] on the action panel.

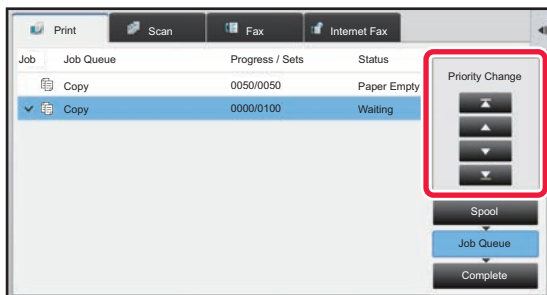

Changing the job order





If there is a job in progress, an interrupt job can be performed, or a job can be moved down in the queue to change the job order. Tap the key of the job you want to move, and tap the "Priority Change" key.



-  key
Moves the selected job to the top of the queue. The current job will be interrupted and the selected job starts.
-  key
Moves the selected job up one position. When the second job from the top is selected, tapping this key interrupts the current job and starts the selected job.
-  key
Moves the selected job down one position.
-  key
Moves the selected job to the bottom of the queue.

Scanner job with a timer setting

When a scanner job with a timer setting is selected, tapping the order change keys moves the job as follows.

-  key
The timer setting is cancelled and the job moves to the position after the job in progress (second from top).
-  key
The timer setting is cancelled and the job moves to the lowest position in the queue (if there are 3 jobs, the 4th position)
-  ,  key
These keys cannot be used.



The jobs below cannot be moved.

Job currently in progress, interrupt copy jobs, list print jobs, and jobs when Passing Prohibited is set in the system settings.



In print tab, you can switch the display in the "Job Queue" screen between the number of printed copies and remaining copies to be printed for each job.

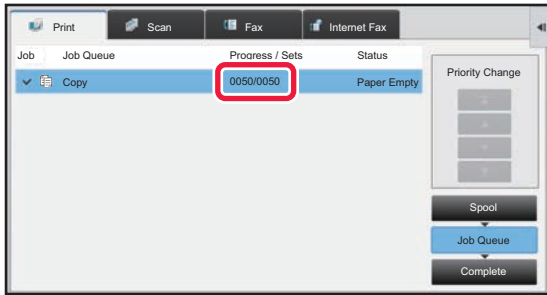

To switch the display between the numbers of printed copies and remaining copies to be printed for each job:
In "Settings (administrator)", select [System Settings] → [Common Settings] → [Operation Settings] → [Condition Settings] → [Switch the Number of Sets to be Displayed for Job Status].

CHECKING A RESERVED JOB OR THE JOB IN PROGRESS

1 Tap the job status display and tap the tab for the job whose contents you wish to check.

2

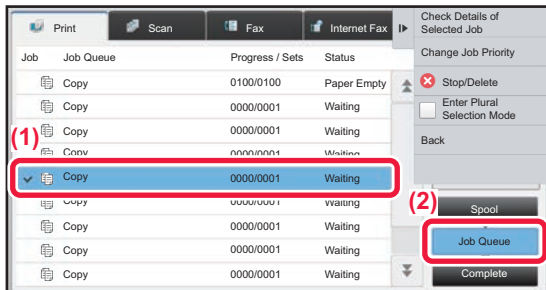

Tap the [Job Queue] key.

3 Tap the job whose contents you wish to check and then tap [Check Details of Selected Job] on the action panel.



- Different job contents appear in different modes.
- For information on the icons displayed on the job keys or the messages displayed in "Status", see "[READING THE JOB LIST \(page 1-95\)](#)".



CHECKING COMPLETED JOBS

1

Tap the job status display and tap the tab for the job whose contents you wish to check.

2

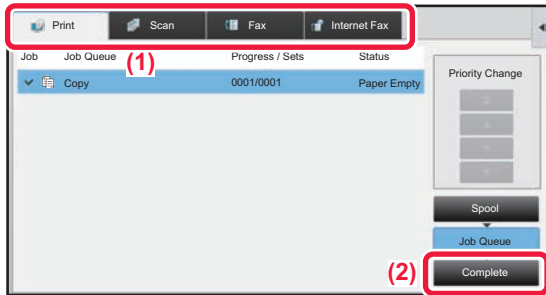

Tap the [Complete] key.

3

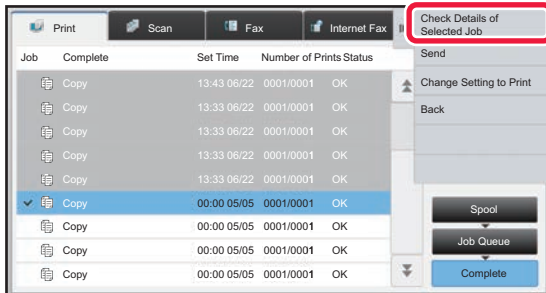

Tap the job whose contents you wish to check and then tap [Check Details of Selected Job] on the action panel.

Jobs you can check are displayed as keys so that you can tap them.

















- Different job contents appear in different modes.
- For information on the icons displayed on the job keys or the messages displayed in "Status", see "[READING THE JOB LIST \(page 1-95\)](#)".



READING THE JOB LIST

The meaning of each job icon and message displayed in "Status" is as follows:

Icons indicating the job type

	Print job (RGB/CMYK)		Copy job
	Scan to E-mail job		Scan to FTP job
	Scan to Network Folder job		Scan to Desktop job
	Fax transmission job		Fax reception job
	PC-Fax transmission job		Internet fax transmission job (Including Direct SMTP)
	PC-I-Fax transmission job		Scan to HDD file print job
	Internet fax reception job (Including Direct SMTP)		Broadcast job* Inbound routing job
	Tandem copy/print job		OSA Scan Job

* This appears in a multi-mode broadcast job.



Messages displayed in "Status"

Job in progress

Display	Status
"Printing"	Print job in progress
"Copying"	Copy job in progress
"Connecting"	Connecting
"Sending"	Sending
"Receiving"	Receiving
"Processing"	Processing
"Tel"	Speaking with the other party using an extension telephone
"Stopped"	The job has been stopped.
"Toner Empty"	Toner Empty
"Paper Empty"	Paper Empty
"Paper Jam"	Paper jam
"Waiting"	Waiting
"Warming up"	Warming up
"Limit"	Having reached the account limit
"Error"	An error occurred while the job was being executed.

Reserved job

Display	Status
"Waiting"	The job is waiting to be executed.
"Retry Mode"	The job is being retried due to a communication error or other problem.
"Report Wait"	Waiting for confirmation of Internet fax transmission
A day and time is displayed	Timer transmission job (the specified time is displayed)

**Completed job**

Display	Status
"OK"	Normal termination
"Send OK"	Transmission was completed.
"NG Ck Line"	Fax line cable is not connected
"In Memory"	Reception completed but the fax has not been printed.
	The received data (each page) has not been printed or forwarded. (The received data has not been deleted.)
"Received"	Printed received fax data.
	The fax has been received.
	The received data (each file) was stored.
"Forward OK"	The received data/received data (each file) has been forwarded.
"Stopped"	The job was stopped.
"Delete"	Deleted received data in the image check screen.
"Number of successful transmission destinations/Total destinations OK"	Completion of a broadcast transmission, serial polling, or inbound routing operation.
	If transmission to 3 destinations was successful out of a total of 5, "003/005 OK" will appear.
"No Response"	An error occurred because there was no response from the destination.
"Busy"	An error occurred because the other party was busy.
"Received"	E-mail other than Internet fax received
"Rejected"	A fax was sent from a party that has been blocked by the anti junk fax function.
"NGxxxxx"	Transmission/reception was not successful because a communication error occurred (a 6-digit error code appears in xxxxxx.)
"Error"	An error occurred while the job was being executed.
"displayed"*	Displayed at the receiving machine when delivery confirmation is set
"dispatched"*	Forwarded elsewhere before being displayed at the receiving machine when delivery confirmation is set
"processed"*	Processed without being displayed at receiving machine when delivery confirmation is set
"deleted"*	Message deleted at receiving machine when delivery confirmation is set
"denied"*	Receiving machine refused to notify sending machine of message processing content when delivery confirmation is set
"failed"*	An abnormal condition occurred when delivery confirmation is set

* If the receiving machine is a SHARP machine, the receiving machine will return "dispatched" if the fax was received normally, or "processed" if reception failed.
When delivery confirmation is set for Internet Fax, the disposition feeld value indicated on the delivery confirmation return e-mail appears.



ADDRESS BOOK

ADDRESS BOOK

"Contacts" and "Group" can be stored in the address book.

For a contact, more than one address can be stored, including fax, e-mail, Internet fax and direct SMTP addresses. Registering addresses stored as "Contacts" as well as directly entered addresses as "Group" enables you to easily send messages to multiple destinations simply by specifying a group.

Address Book

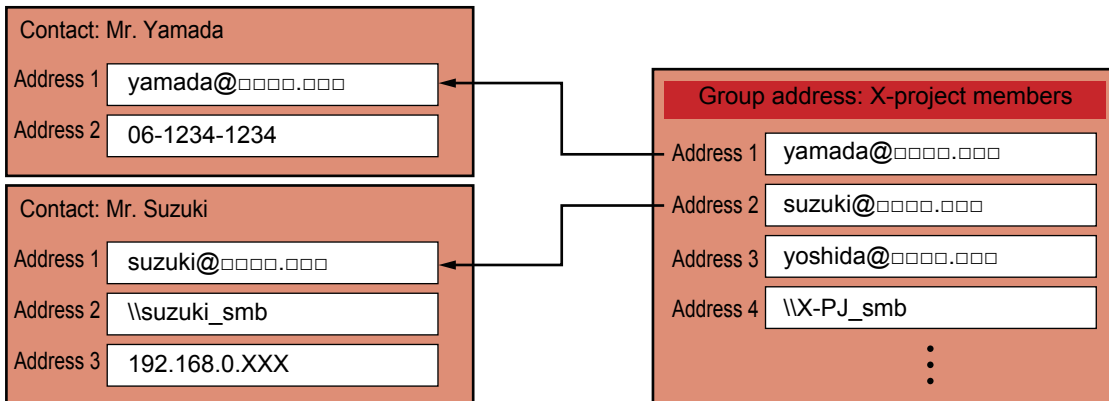

- Up to 2000 entries in all can be stored for "Contacts" and "Group".
- The address book can store up to 6000 addresses.
- One "Contacts" can store up to 500 addresses.
- One "Group" can store up to 500 addresses.
- A group that combines direct SMTP with other sending methods cannot be used for transmission.



ADDRESS BOOK SCREEN

To display the address book, tap the [Address Book] key on the base screen in image send mode such as fax, e-mail, or Internet fax. You can also display it by tapping the [Address Book] icon in the home screen. "Contacts" and "Group" registered are enabled for alphabetical search and selected condition-based advanced search.



- When the [Address Book] key is tapped on the e-mail base screen, groups and contacts having e-mail addresses are displayed.
- If user authentication is enabled, registered contacts can be shared within a specified group or stored as personal contacts that only you are allowed to access.
 - [SETTING THE SCOPE FOR PUBLICIZING CONTACTS AND GROUPS \(page 1-110\)](#)
- You can tap the [Find My Address] key while logging in and select your e-mail address from the user list. This is convenient when you want to send an e-mail to yourself.
 - [Disabling of Find My Address \(page 7-96\)](#)

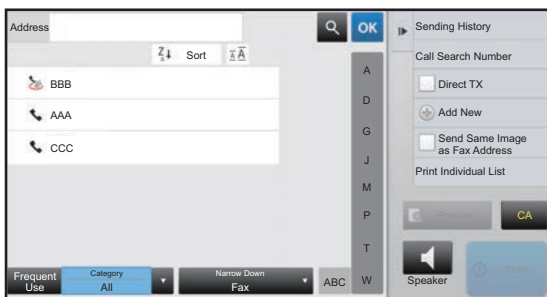

Selecting "Contacts" or "Group"

Tap a "Contacts" or "Group", and the tapped "Contacts" or "Group" is selected.

After selection, tap **OK**.

To add "Contacts" and "Group", refer to the following.

- [STORING ADDRESSES THROUGH DIRECT ENTRY \(page 1-102\)](#)
- [STORING ADDRESSES THROUGH GLOBAL ADDRESS SEARCH \(page 1-103\)](#)
- [STORING ADDRESSES FROM FAX OR IMAGE SEND LOGS \(page 1-105\)](#)
- [STORING GROUPS \(page 1-106\)](#)

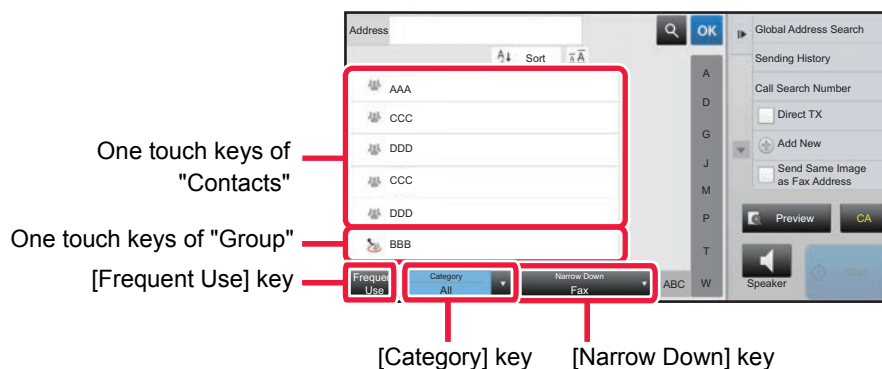



Narrowing by frequent Use

Tap the [Frequent Use] key and select an address in the screen that appears. Addresses registered as "Frequent Use" addresses are shown.

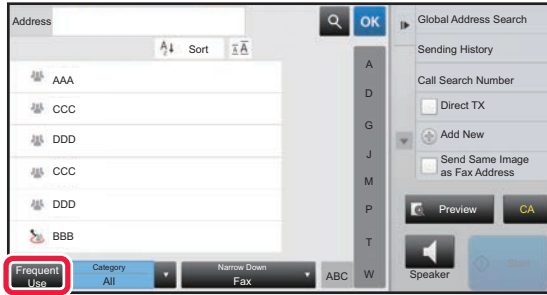

Narrowing by category

Tap the [Category] key to select a category on the screen that appears. The "Contacts" and "Group" in the selected category appear on a list. The narrowed-down condition is displayed under the [Category] key.

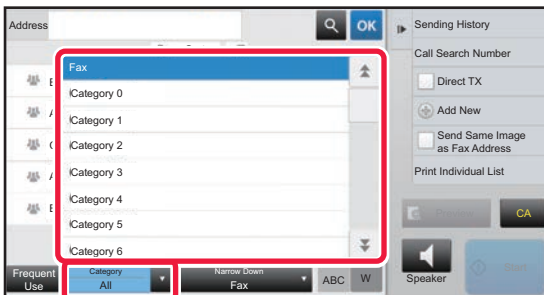

Narrowing by job type

Tap the [Narrow Down] key to select a job on the screen that appears. To narrow by "Group", tap the [Group] key. The "Contacts" and "Group" for the selected job appear on a list. The narrowed-down condition is displayed under the [Narrow Down] key.

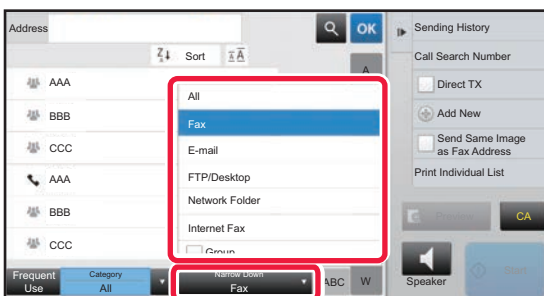



Narrowing by index

Search by alphabet to narrow down addresses.

For example, tap "A" on the index bar to display "Contacts" stored with search text starting with "A".

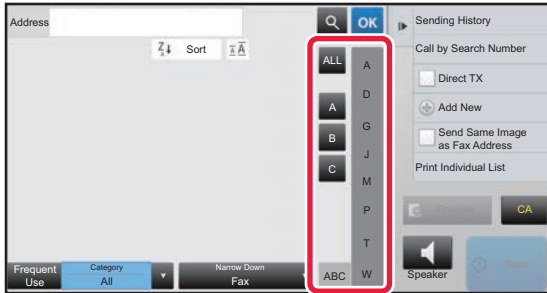

Narrowing by keyword

Tap to display a search screen. Select a target for search, enter a keyword and then tap the [Search Start] key. The search results are listed.

For example, if [Item] is [Name], search with a keyword "SH" lists contacts and groups starting with "SH".

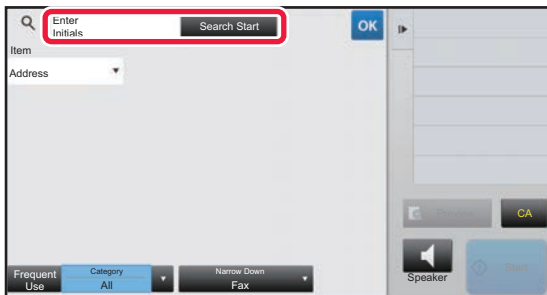

Displaying in the order of search numbers

Tapping the [Sort] key displays a list in ascending order, descending order, or in the order of search numbers.

The display is switched in the order of [Sort] (▲) (Up) → [Sort] (▼) (Down) → Search Number Order.





STORING ADDRESSES THROUGH DIRECT ENTRY

Store new names or addresses in the address book by directly entering them.

1

In the address book screen, tap **[Add New]** on the action panel, or tap the **[Address Control]** icon in the home screen.

2

Enter basic information.

Be sure to enter **[Name]** and **[Initial]**.

To specify a category, select one from a category list that appears when the entry box is tapped.

To register for frequent use, select the **[Also Register for Frequent Use]** checkbox .



To register a category name:

In "Settings (Web version)", select **[Address Book]** → **[Category Setting]**.



If user authentication is enabled, the tab for address publication setting appears. Setting address publication enables stored "Contacts" and "Group" to be shared within a specified group or stored as personal contacts that only you are allowed to access.

► [SETTING THE SCOPE FOR PUBLICIZING CONTACTS AND GROUPS \(page 1-110\)](#)

3

Tap **[Fax Number]**, **[E-mail Address]**, **[Internet Fax Address]**, or **[Direct SMTP Address]** to enter the address, and tap

OK.



- Select the checkbox to set that address as the preferred over the others if two or more addresses are stored for "Contacts".
- FTP, Desktop, and Network Folder addresses can be registered from **[Address Book]** in "Settings (Web version)".

4

Tap the **[Register]** key.

The first address of each address type is set as the default address. If no address has the checkbox next to it selected, a confirmation screen will appear asking you if you want to select a default address.



STORING ADDRESSES THROUGH GLOBAL ADDRESS SEARCH

Store the results of searching the global address book as new addresses in the address book.



Global address search requires an LDAP server.

1

In the address book screen, tap [Add New] on the action panel, or tap the [Address Control] icon in the home screen.

2

Enter basic information.

Be sure to enter [Name] and [Initial].

To specify a category, select one from a category list that appears when the entry box is tapped.

To register for frequent use, select the [Also Register for Frequent Use] checkbox .



To register a category name:

In "Settings (Web version)", select [Address Book] → [Category Setting].



If user authentication is enabled, the tab for address publication setting appears. Setting address publication enables stored "Contacts" and "Group" to be shared within a specified group or stored as personal contacts that only you are allowed to access.

► [SETTING THE SCOPE FOR PUBLICIZING CONTACTS AND GROUPS \(page 1-110\)](#)

3

Tap the [Global Search] key.

4

Select the server from the list of servers.

If an authentication screen appears, enter your user name and password, and tap the [OK] key.

► [AUTHENTICATION BY LOGIN NAME/PASSWORD \(page 1-34\)](#)

After selecting a server, tap .



5

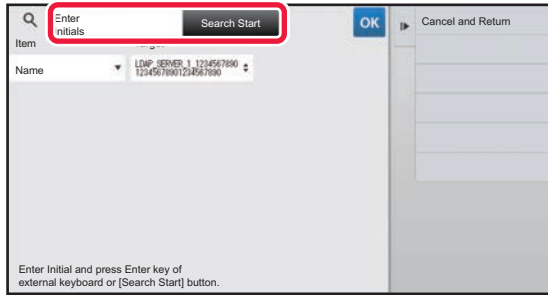

Tap the entry field to enter the search condition and then tap the [Search Start] key.

To change the search target, tap for [Item]. You can select [Name] or [Address].

6

Select one address from the search result list, and tap the key.



To check address information, select the address and tap the [Confirm Registered Information] key.

7

Tap the [Register] key.

The first address of each address type is set as the default address. If no address has the checkbox next to it selected, a confirmation screen will appear asking you if you want to select a default address.



STORING ADDRESSES FROM FAX OR IMAGE SEND LOGS

As a new registration, add an address you have entered via fax or image send operations to the address book.



FTP and desktop addresses cannot be stored in the address book from transmission logs.

1

In fax or image send mode, tap [Sending History] on the action panel.

2

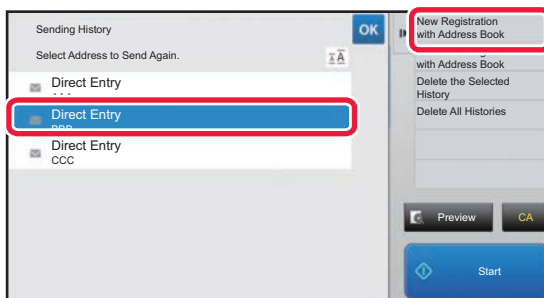

Select one address you want to register in the address book from the send logs, and then tap [New Registration with Address Book] on the action panel.



When you tap [Additional Registration with Address Book] on the action panel, you can add the address to a contact stored in the address book.

3

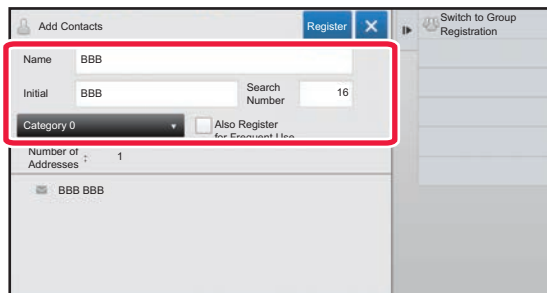

Enter basic information.

Be sure to enter [Name] and [Initial].
To specify a category, select one from a category list that appears when the entry box is tapped.
To register for frequent use, select the [Also Register for Frequent Use] checkbox .



If user authentication is enabled, the tab for address publication setting appears. Setting address publication enables stored "Contacts" and "Group" to be shared within a specified group or stored as personal contacts that only you are allowed to access.

► [SETTING THE SCOPE FOR PUBLICIZING CONTACTS AND GROUPS \(page 1-110\)](#)



To register a category name:

In "Settings (Web version)", select [Address Book] → [Category Setting].

4

Tap the [Register] key.

The address is registered in the address book and the transmission log screen is restored.

The first address of each address type is set as the default address. If no address has the checkbox next to it selected, a confirmation screen will appear asking you if you want to select a default address.



5 Tap the [OK] key.

STORING GROUPS

Register "Group" by selecting addresses from those already stored as "Contacts". In this case of registration, only reference to addresses already stored takes place, and so, the total number of registered addresses (maximum 6000) in the address book does not increase. You can also directly enter a new address for a "Group".

1 In the address book screen, tap [Add New] on the action panel, or tap the [Address Control] icon in the home screen.

2

Enter the basic information, and tap [Switch to Group Registration] on the action panel.

3

Tap the [Address Book] key.



To directly enter a new address for a "Group", tap [Fax Number], [E-mail Address], [Internet Fax Address], or [Direct SMTP Address].

4

In the contact list, tap the "Contacts" that includes the address you want to add to the "Group", and tap [Display Registered Information] on the action panel.



5

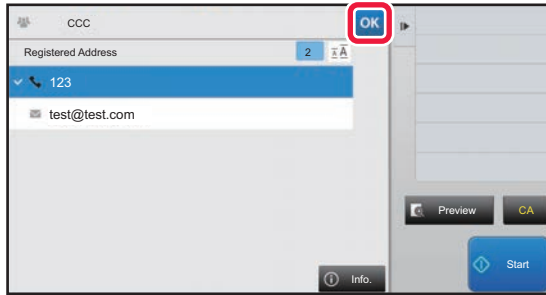

Tap the address to be registered in the "Group", and then tap the **OK** key.

You can select more than one address.

6

Repeat steps 3 through 5 to register addresses. After address registration is completed, tap **OK** key.

7

Tap the [Register] key.



EDITING/DELETING ADDRESSES IN ADDRESS BOOK

You can edit or delete "Contacts" or "Group" information stored in the address book as well as addresses listed under "Contacts" and "Group".

Editing/deleting contacts and groups

1

In the address book screen, select a contact or group you wish to edit, and tap [Edit] on the action panel.

To delete a "Contacts" or "Group", tap [Delete] on the action panel.



- For editing, you can only select one "Contacts" or "Group" at a time.
- For deleting, you can select more than one "Contacts" or "Group" at a time.
- If you have logged in as the administrator, you can delete all addresses stored in the address book by using the [Delete All] that appears on the action panel.

2

Editing a "Contacts" or "Group"

- You can change basic information such as names and categories and also you can add addresses.
 - ▶ [STORING ADDRESSES THROUGH DIRECT ENTRY \(page 1-102\)](#)
 - ▶ [STORING ADDRESSES THROUGH GLOBAL ADDRESS SEARCH \(page 1-103\)](#)
 - ▶ [STORING ADDRESSES FROM FAX OR IMAGE SEND LOGS \(page 1-105\)](#)
 - ▶ [STORING GROUPS \(page 1-106\)](#)
- You can change the publicity scope.
 - ▶ [SETTING THE SCOPE FOR PUBLICIZING CONTACTS AND GROUPS \(page 1-110\)](#)



Editing/deleting addresses

1

Select a contact or group you wish to edit, and tap [Edit] on the action panel. In the address book screen, select the contact or group that has the address you want to edit, and tap [Edit] on the action panel.

Only one contact or group can be selected. If more than one is selected, the [Edit] key does not appear.

2

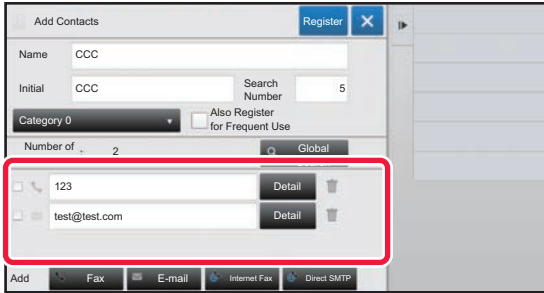

Tap the address display in the list of addresses.

To delete an address, tap the  key.



- To edit or delete, you can only select one address at a time.
- To check address information, tap the [Detail] key.



You cannot edit or delete an address for a job in a job queue.

3

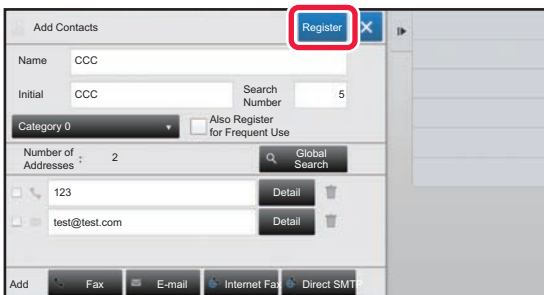

Edit an address.

After editing, tap the [Register] key.



You can only edit addresses in the network folder on the edit screen. (The Add New screen cannot be displayed.)



SETTING THE SCOPE FOR PUBLICIZING CONTACTS AND GROUPS

"Contacts" and "Group" stored in the address book can be shared within a specified group or stored as personal contacts that only you are allowed to access.

If no publicity scope is specified, stored "Contacts" and "Group" are publicized to all users.



User authentication is required to set the scope for publicizing "Contacts" and "Group".

Scope for publicizing addresses	Description
Publicized to all	"Contacts" and "Group" are published to all users of the machine.
User	"Contacts" and "Group" are published only to the user. Registered addresses are preferentially displayed as "Personal Contacts" in the user's address book.
User Group	Publication of "Contacts" and "Group" is limited to the specified group. Up to eight groups per "Contacts" or "Group" can be set as the publicity scope.

1

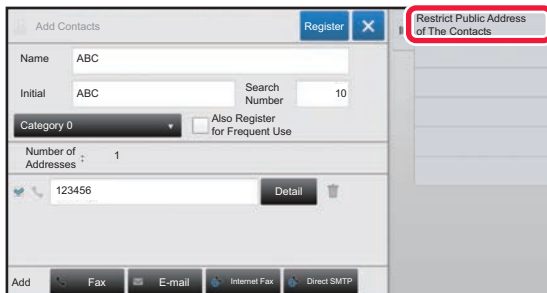

In the address registration screen, tap [Restrict Public Address of The Contacts] on the action panel.

2



Tap the [Designate Public Address] key.

3

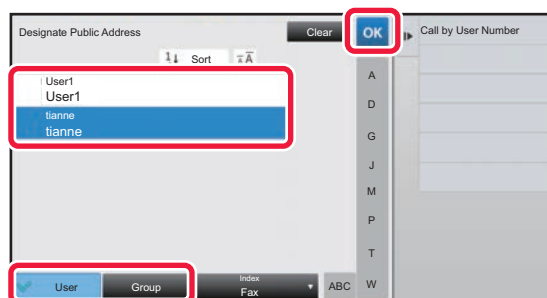

Tap [User] or [Group] and specify who the address is made public to.

After the settings are completed, tap **OK**.



If you have logged in as the administrator, select any user name desired from the user list.



To register a user:

In "Settings (administrator)", select [User Control] → [User Control] → [User List] → [User Registration].

DELETING THE TRANSMISSION HISTORY

You can delete the fax or image send transmission history.



The transmission history is deleted in normal mode.

Deleting a selected history

1

Tap the history you want to delete.

2

In the transmission log screen, tap [Delete the Selected History] on the action panel.

3

The message "Delete the selected history?" will appear, tap the [Delete] key.

The selected transmission log is deleted.

Deleting all transmission histories

1

In the transmission log screen, tap [Delete All Histories] on the action panel.

2

The message "Delete all histories?" will appear, tap the [Delete All] key.

All transmission logs are to be deleted.



PERIPHERAL DEVICES

PERIPHERAL DEVICES

Peripheral devices can be installed on the machine to increase its range of functionality.

The peripheral devices are generally optional. However, some models include certain peripheral devices as standard equipment.

(As of November, 2017)

Product name	Product number	Description
Stand/550 sheet paper drawer	MX-DE25 N	Additional tray. A maximum of 550 sheets of paper can be loaded into the tray.
Low stand/550 sheet paper drawer	MX-DE29 N	
Stand/2x550 sheet paper drawer	MX-DE26 N	Additional tray. A maximum of 550 sheets of paper can be loaded into each tray.
Stand/3x550 sheet paper drawer	MX-DE27 N	
Stand/550&2100 sheet paper drawer	MX-DE28 N	Additional tray. The maximum number of sheets that can be loaded is 550 sheets in tray 2, 1200 sheets in tray 3, and 900 sheets in tray 4.
Large capacity tray	MX-LC17 N	Additional tray. A maximum of 3000 sheets of paper can be loaded into the tray.
Long paper feeding tray	MX-LT10	When using long paper, the long paper is loaded in the bypass tray.
Exit tray unit	MX-TR19 N	When a finisher is installed, this can be added to the right side of the machine.
Exit tray cabinet	MX-TU16	This enables separation of output locations by mode (copy, printer, etc.).
Job separator tray	MX-TR20	
Inner finisher	MX-FN27 N	Output device that enables the use of the staple function and offset function.
Finisher	MX-FN28	Output device that enables the use of the staple function and offset function. To install the finisher, a stand/550, stand/2x550, stand/3x550, or 550&2100 sheet paper drawer is required.
Finisher (large stacker)	MX-FN30	
Saddle stitch finisher	MX-FN29	Output device that enables use of the staple function, offset function and booklet function. To install the finisher, a stand/550, stand/2x550, stand/3x550, or 550&2100 sheet paper drawer is required.
Saddle stitch finisher (large stacker)	MX-FN31	
Paper pass unit	MX-RB25 N	This unit is required to install a finisher or a saddle stitch finisher.
Punch module	MX-PN14A MX-PN14B MX-PN14C MX-PN14D	This unit punches holes in copies and other output. An inner finisher (MX-FN27 N) is required.
	MX-PN15A MX-PN15B MX-PN15C MX-PN15D	This unit punches holes in copies and other output. A finisher or saddle stitch finisher (MX-FN28/MX-FN29) is required.



Product name	Product number	Description
Punch module	MX-PN16A MX-PN16B MX-PN16C MX-PN16D	This unit punches holes in copies and other output. A finisher (large stacker) or saddle stitch finisher (large stacker) (MX-FN30/MX-FN31) is required.
PS3 expansion kit* ¹	MX-PK13	Enables the machine to be used as a Postscript compatible printer.
Barcode font kit	MX-PF10	Adds barcode fonts to the machine.
Facsimile expansion kit	MX-FX15	Enables Fax.
Internet fax expansion kit	MX-FWX1	Enables Internet Fax.
Direct print expansion kit* ¹	MX-PU10	This enables direct printing of DOCX, XLSX, and PPTX files without going through a computer.
Application integration module	MX-AMX1	The application integration module can be combined with the network scanner function to append a metadata file to a scanned image file.
Application communication module* ¹	MX-AMX2	This allows the machine to be linked over a network to an external software application.
External account module* ¹	MX-AMX3	This is required to use an external account application on the machine.
Sharpdesk 1 license kit	MX-USX1	This software enables integrated management of documents and computer files.
Sharpdesk 5 license kit	MX-USX5	
Sharpdesk 10 license kit	MX-USX10	
Sharpdesk 50 license kit	MX-USX50	
Sharpdesk 100 license kit	MX-USXA0	
Stamp unit	AR-SU1	
The stamp cartridge	AR-SV1	Two stamp cartridges are included in a package.
Enhanced compression kit* ²	MX-EB11	Saves a scanned document in the Compact PDF format. Compact PDF results in a smaller size than regular PDF.
Wireless LAN Adaptor* ¹	MX-EB18	Adds the wireless LAN function to the machine.
Utility table	MX-UT10	You can use this as a work platform, or temporarily place originals or a mobile device.

*¹ These peripheral devices can be installed on the MX-2630N/MX-3050V/MX-3550V/MX-4050V/MX-5050V/MX-6050V. (These devices are equipped standard on the MX-3060V/MX-3070V/MX-3560V/MX-3570V/MX-4060V/MX-4070V/MX-5070V/MX-6070V.)

*² These peripheral devices can be installed on the MX-3050V/MX-3550V/MX-4050V/MX-5050V/MX-6050V. (These devices are equipped standard on the MX-3060V/MX-3070V/MX-3560V/MX-3570V/MX-4060V/MX-4070V/MX-5070V/MX-6070V.) These peripheral devices can not be installed on the MX-2630N



Some options may not be available in some countries and regions.



INNER FINISHER

This device outputs sorted paper while staggering each set of paper. As needed, it staples each set. You can also perform stapling manually.

To punch holes in printed paper, install an optional hole punch module.

PART NAMES

The following describes the parts that appear when the finisher is open.

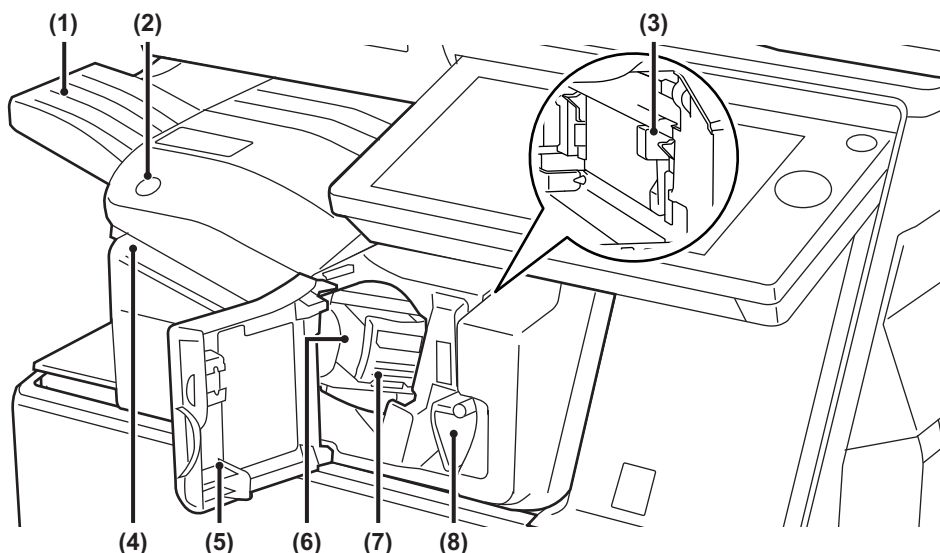

- | | |
|--|--|
| <p>(1) Output tray
Stapled and offset output is delivered to this tray. The tray is slidable. To print on large paper such as A3 size, extend the tray.</p> <p>(2) Manual staple key
Press to execute manual stapling.</p> <p>(3) Punch waste box (when a punch module is installed)
This stores punch waste discharged from punching.</p> <p>(4) Insertion slot
Place the paper that you want to staple in this slot. Maximum thickness 4 mm.</p> | <p>(5) Front cover
Open this cover to remove a paper misfeed, replace staples, remove a staple jam, or remove the punch waste box.</p> <p>(6) Staple case
This holds the staple cartridge. Pull the case out to replace the staple cartridge or remove a staple jam.</p> <p>(7) Staple case release lever
Use this lever to remove the staple case.</p> <p>(8) Lever
Use this lever to move the finisher in order to remove a paper misfeed, or remove a staple jam.</p> |
|--|--|



- The inner finisher cannot be installed at the same time as the finisher, finisher (large stacker), saddle stitch finisher or saddle stitch finisher (large stacker).
- Exercise caution when you turn on the power and when printing take place, as the output tray may move up and down.



HOW TO STAPLE MANUALLY

You can perform stapling manually.
Make sure the manual staple key is lit green.

1

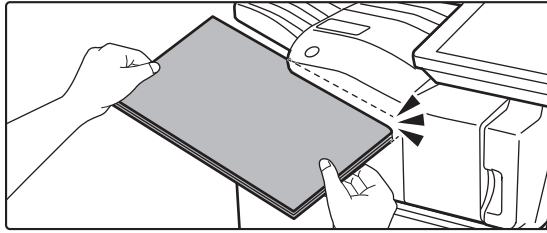

Place the paper that you want to staple in the insertion slot.

When you place the paper, the manual staple key blinks green.

After two seconds elapse, stapling automatically starts.



- To staple earlier than the auto staple start time, press the manual staple key.

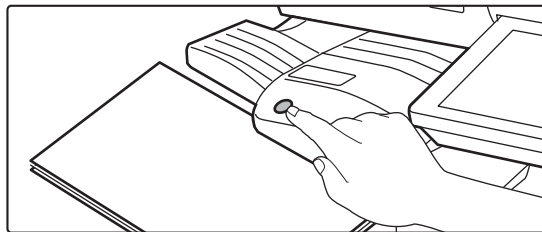

- Manual stapling cannot be executed during execution of a staple job.

Relation between paper orientation and stapling result

Paper	Paper orientation when inserted	After stapling



SUPPLIES

The finisher requires the following staple cartridge:
Staple cartridge (approx. 5000 staples per cartridge x three cartridges)
MX-SCX1

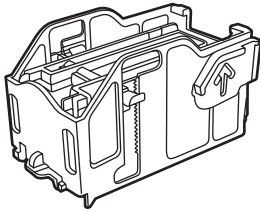

INNER FINISHER MAINTENANCE

When the staple cartridge runs out of staples, a message will appear in the operation panel. Follow the operation procedure to replace the staple cartridge.

Replacement the staple cartridge

1

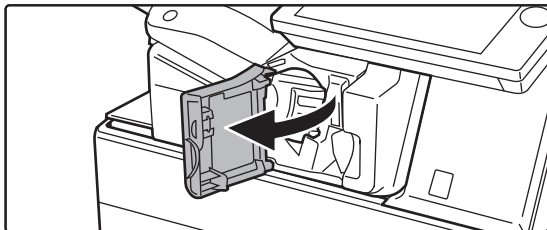

Open the finisher front cover.

2



Lower the staple case release lever and remove the staple case.

Pull the staple case out to the right.

3

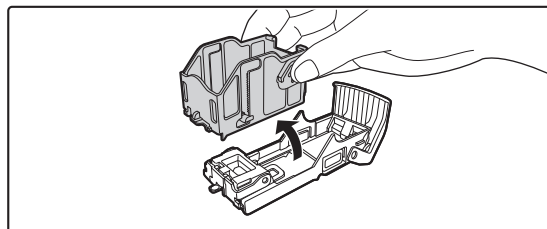

Remove the empty staple cartridge from the staple case.



4

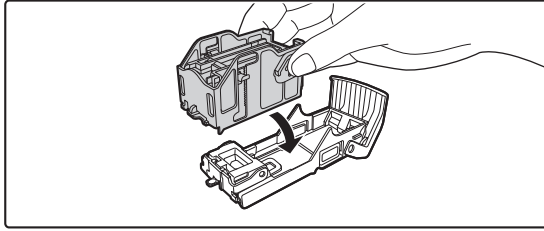

Insert a new staple cartridge into the staple case as shown.

Push the staple cartridge in until it clicks into place.

5

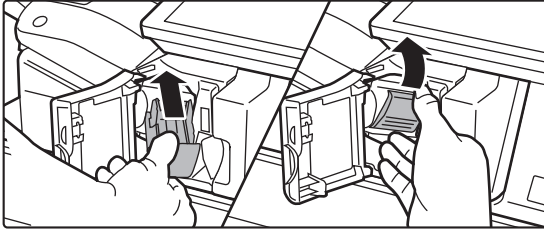

Push the staple case.

Push the staple case in until it clicks into place.

6

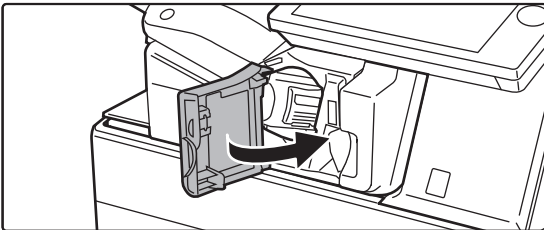

Close the finisher front cover.



Make a proof copy in staple sort function to verify that stapling takes place correctly.



FINISHER

This device outputs sorted paper while staggering each set of paper. As needed, it staples each set. To punch holes in printed paper, install an optional hole punch module.

PART NAMES

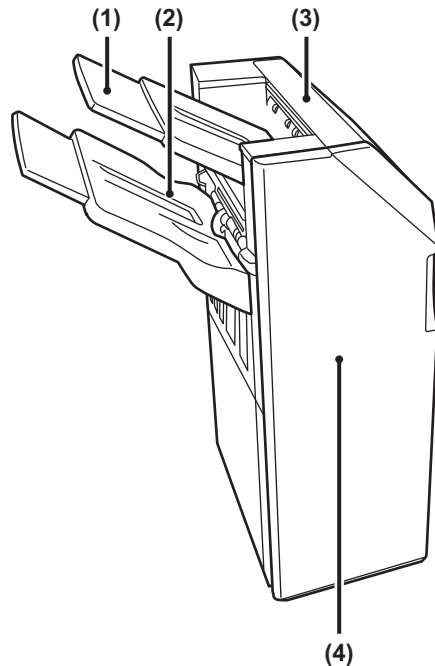

(1) Output tray (upper tray)

The tray is slidable. To print on large paper such as A3 paper, extend the tray.

(2) Output tray (lower tray)

Stapled and offset output is delivered to this tray. The tray is slidable. To print on large paper such as A3 paper, extend the tray.

(3) Top cover

Open this cover to remove a paper misfeed.

(4) Front cover

Open this cover to replace the staple cartridge or remove a staple jam.



- To install a finisher, a paper pass unit and stand/550/2x550/3x550/550&2100 sheet paper drawer are required.
- A finisher cannot be installed simultaneously with an inner finisher, finisher (large stacker), saddle stitch finisher or saddle stitch finisher (large stacker).
- Do not place heavy objects on the finisher or press down on the finisher.
- Exercise caution when you turn on the power and when printing take place, as the tray may move up and down.



SUPPLIES

The finisher requires the following staple cartridge:

Staple cartridge (approx. 5000 staples per cartridge x three cartridges)

MX-SCX1

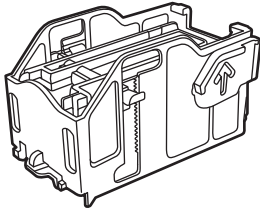

FINISHER MAINTENANCE

When the staple cartridge runs out of staples, a message will appear in the operation panel. Follow the operation procedure to replace the staple cartridge.

Replacement the staple cartridge

1

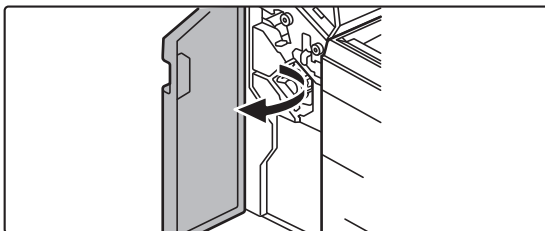

Open the front cover.

2

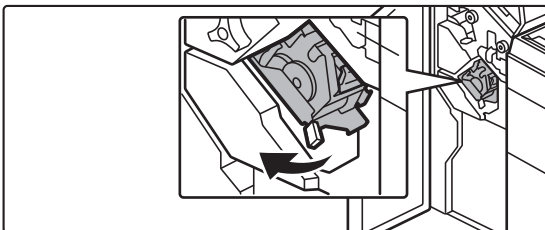

Pull out the staple unit.

3

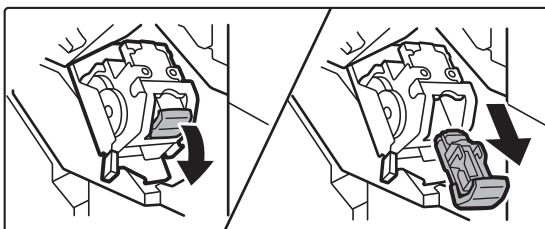

Remove the staple case.



4

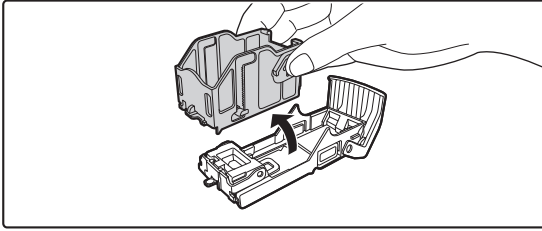

Remove the empty staple cartridge from the staple case.

5

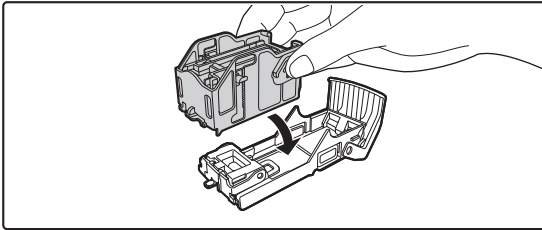

Insert a new staple cartridge into the staple case as shown.

Push the staple cartridge in until it clicks into place.

6

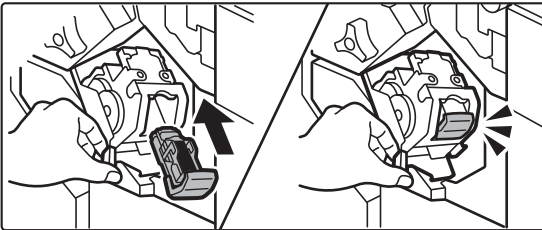

Push the staple case firmly back in.

Push the staple case in until it clicks into place.

7

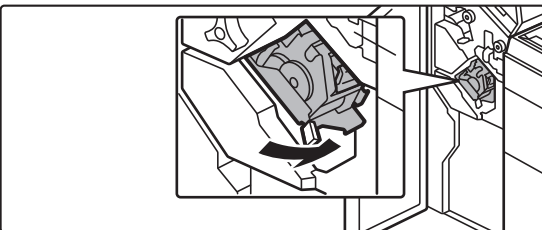

Replace the staple unit.

8



Close the front cover.



Make a proof copy in staple sort function to verify that stapling takes place correctly.



FINISHER (LARGE STACKER)

This device outputs sorted paper while staggering each set of paper. As needed, it staples each set. You can also perform stapling manually. To punch holes in printed paper, install an optional hole punch module.

PART NAMES

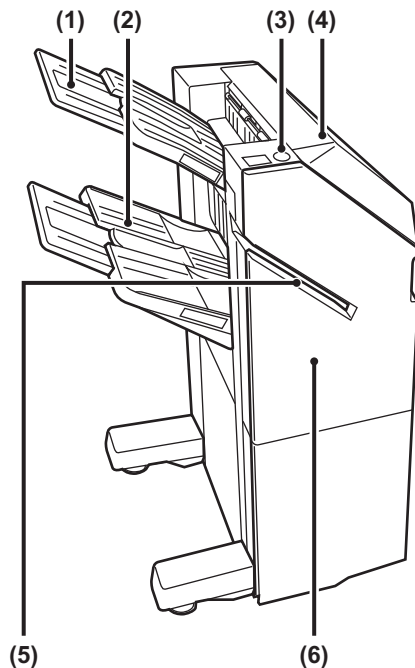

- | | |
|--|---|
| <p>(1) Output tray (upper tray)
The tray is slidable. To print on large paper such as A3 paper, extend the tray.</p> <p>(2) Output tray (lower tray)
Stapled and offset output is delivered to this tray. The tray is slidable. To print on large paper such as A3 paper, extend the tray.</p> <p>(3) Manual staple key
Press to execute manual stapling.</p> | <p>(4) Top cover
Open this cover to remove a paper misfeed.</p> <p>(5) Insertion slot
Place the paper that you want to staple in this slot. Maximum thickness 9 mm.</p> <p>(6) Front cover
Open this cover to replace the staple cartridge or remove a staple jam.</p> |
|--|---|



- To install a finisher (large stacker), a paper pass unit and stand/550/2x550/3x550/550&2100 sheet paper drawer are required.
- A finisher (large stacker) cannot be installed simultaneously with an inner finisher, finisher, saddle stitch finisher or saddle stitch finisher (large stacker).
- Do not place heavy objects on the finisher (large stacker) or press down on the finisher (large stacker).
- Exercise caution when you turn on the power and when printing take place, as the tray may move up and down.



HOW TO STAPLE MANUALLY

You can perform stapling manually.
Make sure the manual staple key is lit green.

1

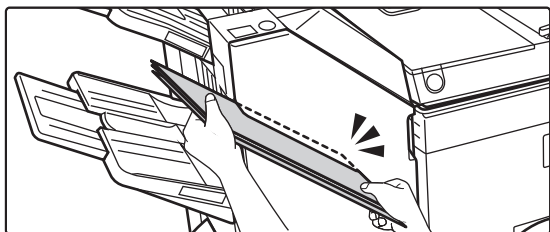

Place the paper that you want to staple in the insertion slot.

When you place the paper, the manual staple key blinks green.

After two seconds elapse, stapling automatically starts.



- To staple earlier than the auto staple start time, press the manual staple key.

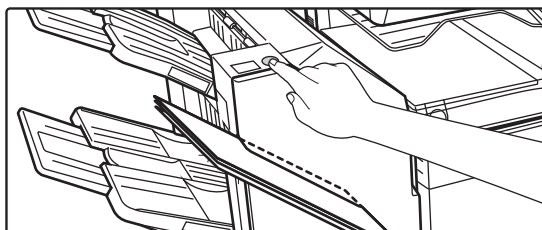

- Manual stapling cannot be executed during execution of a staple job.

Relation between paper orientation and stapling result

Paper	Paper orientation when inserted	After stapling



SUPPLIES

The finisher (large stacker) requires the following staple cartridge:
Staple cartridge (approx. 5000 staples per cartridge x three cartridges)
MX-SC11

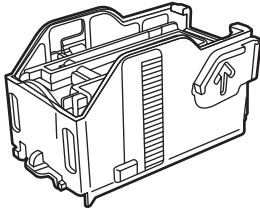

FINISHER (LARGE STACKER) MAINTENANCE

When the staple cartridge runs out of staples, a message will appear in the operation panel. Follow the operation procedure to replace the staple cartridge.

Replacement the staple cartridge

1

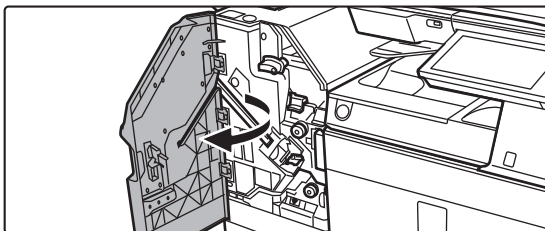

Open the front cover.

2

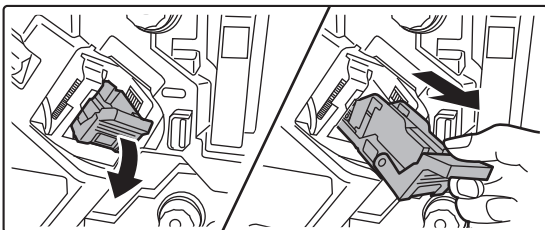

Remove the staple case.

3

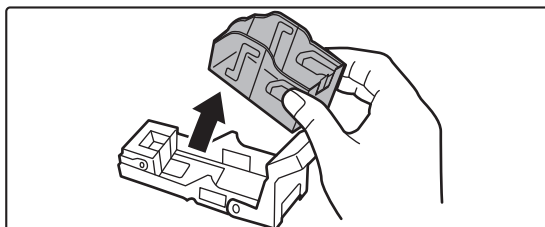

Remove the empty staple cartridge.



4

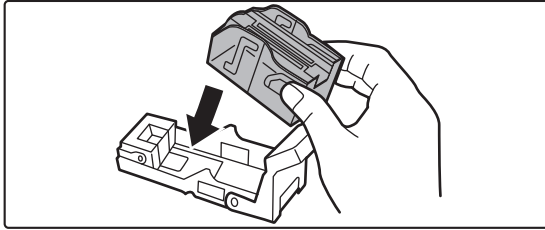

Insert a new staple cartridge into the staple case.

Push the staple cartridge in until it clicks into place.

5



Push the staple case firmly back in.

Push the staple case in until it clicks into place.

6

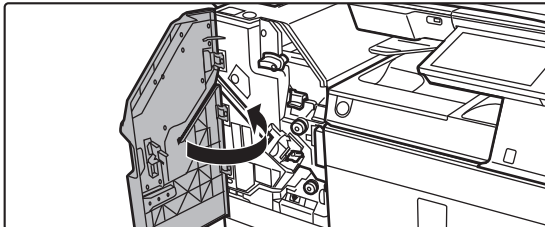

Close the front cover.



Make a proof copy in staple sort function to verify that stapling takes place correctly.



SADDLE STITCH FINISHER

This includes the offset function that outputs sorted paper while staggering each set of paper, the staple sort function that staples each set of prints, the saddle stitch function that automatically staples the centre of the sheets and folds the sheets in half, and the paper folding function that folds paper in half.

To punch holes in printed paper, install an optional hole punch module.

PART NAMES

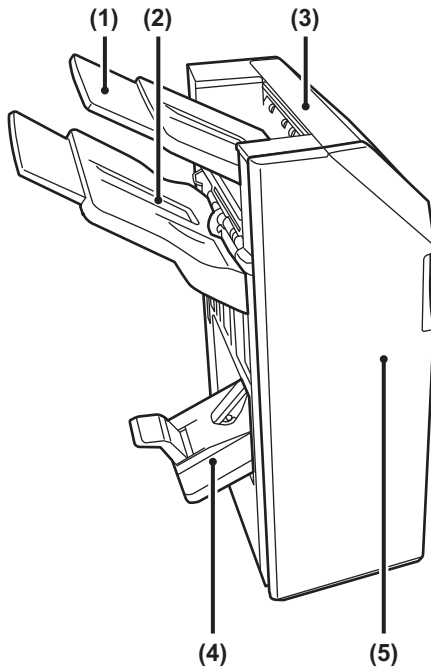

(1) Output tray (upper tray)

The tray is slidable. To print on large paper such as A3 paper, extend the tray.

(2) Output tray (lower tray)

Stapled and offset output is delivered to this tray. The tray is slidable. To print on large paper such as A3 paper, extend the tray.

(3) Top cover

Open this cover to remove a paper misfeed.

(4) Saddle stitch tray

Saddle-stitched output is delivered to this tray.

(5) Front cover

Open this cover to replace the staple cartridge, remove a staple jam, or remove a paper misfeed.



- To install a saddle stitch finisher, a paper pass unit and stand/550/2x550/3x550/550&2100 sheet paper drawer are required.
- Do not place heavy objects on the saddle finisher or press down on the saddle stitch finisher.
- Exercise caution when you turn on the power and when printing take place, as the tray may move up and down.
- A saddle stitch finisher cannot be installed simultaneously with an inner finisher, finisher, finisher (large stacker) or saddle stitch finisher (large stacker).



SUPPLIES

The saddle stitch finisher requires the following staple cartridge:
Staple cartridge (approx. 5000 staples per cartridge x three cartridges)
AR-SC2

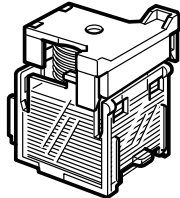

SADDLE STITCH FINISHER MAINTENANCE

When the staple cartridge runs out of staples, a message will appear in the operation panel. Follow the operation procedure to replace the staple cartridge.

1

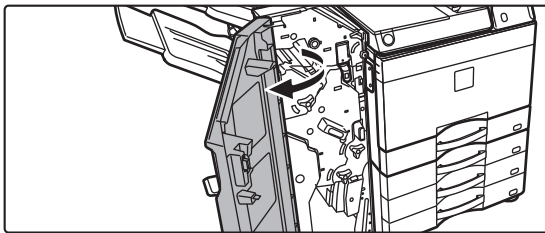

Open the front cover.

2

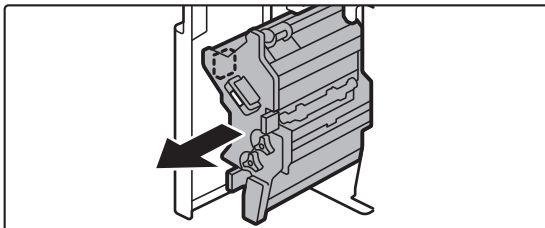

Pull the lever and withdraw the staple unit.

Pull it slowly out until it stops.

3

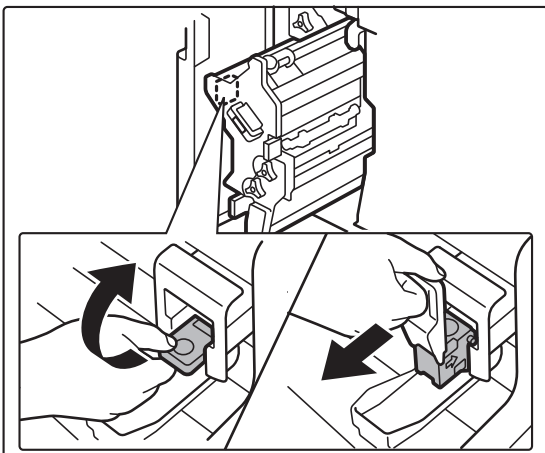

Lower the staple case release lever and remove the staple case.



4

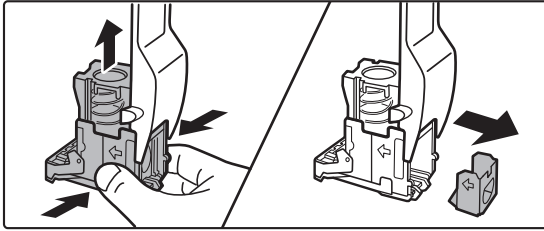

Remove the empty staple cartridge from the staple case.

5

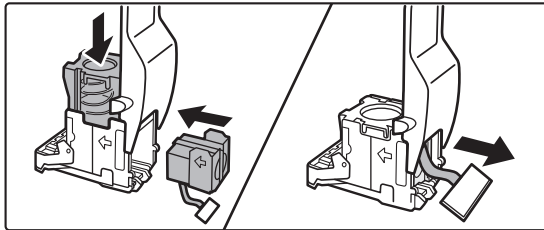

Insert a new staple cartridge into the staple case as shown.

Push the staple cartridge in until it clicks into place. After inserting the staple cartridge, pull the seal that holds the staples straight out.



Do not remove the seal from the cartridge before inserting the cartridge into the case.

6

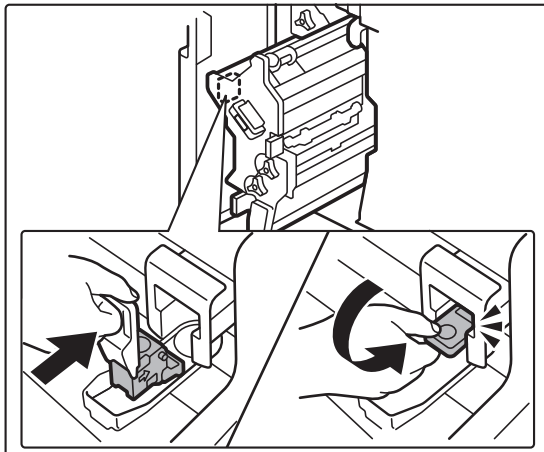

Attach the staple case.

Push the staple case in until it clicks into place.

7

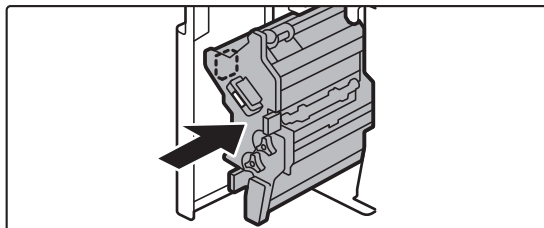

Push the staple unit back in.



8

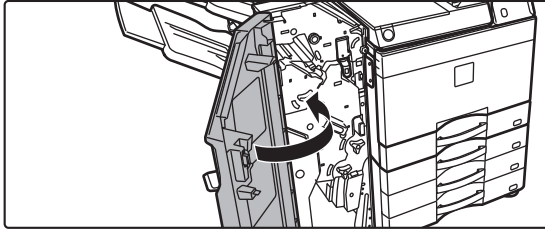

Close the front cover.



Make a proof copy in staple sort function to verify that stapling takes place correctly.



SADDLE STITCH FINISHER (LARGE STACKER)

This includes the offset function that outputs sorted paper while staggering each set of paper, the staple sort function that staples each set of prints, the saddle stitch function that automatically staples the centre of the sheets and folds the sheets in half, and the paper folding function that folds paper in half. You can also perform stapling manually. To punch holes in printed paper, install an optional hole punch module.

PART NAMES

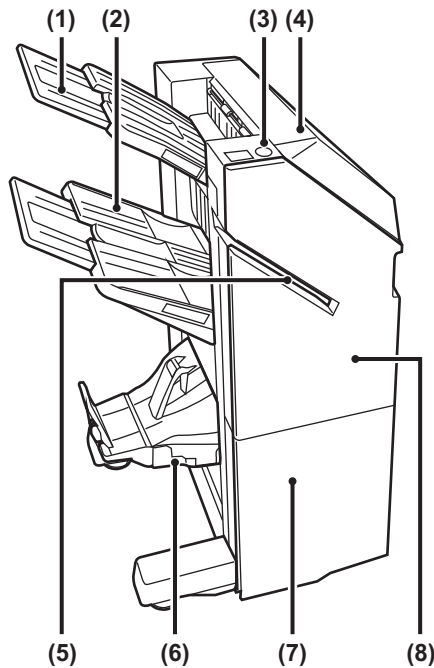

- | | |
|---|---|
| <p>(1) Output tray (upper tray)
The tray is slidable. To print on large paper such as A3 paper, extend the tray.</p> <p>(2) Output tray (lower tray)
Stapled and offset output is delivered to this tray. The tray is slidable. To print on large paper such as A3 paper, extend the tray.</p> <p>(3) Manual staple key
Press to execute manual stapling.</p> <p>(4) Top cover
Open this cover to remove a paper misfeed.</p> | <p>(5) Insertion slot
Place the paper that you want to staple in this slot. Maximum thickness 9 mm.</p> <p>(6) Saddle stitch tray
Saddle-stitched output is delivered to this tray.</p> <p>(7) Front lower cover
Open this cover to replace the staple cartridge, remove a staple jam, or remove a paper misfeed.</p> <p>(8) Front upper cover
Open this cover to replace the staple cartridge, remove a staple jam, or remove a paper misfeed.</p> |
|---|---|



- To install a saddle stitch finisher (large stacker), a paper pass unit and stand/550/2x550/3x550/550&2100 sheet paper drawer are required.
- Do not place heavy objects on the saddle stitch finisher (large stacker) or press down on the saddle stitch finisher (large stacker).
- Exercise caution when you turn on the power and when printing take place, as the tray may move up and down.
- A saddle stitch finisher (large stacker) cannot be installed simultaneously with an inner finisher, finisher, finisher (large stacker) or saddle stitch finisher.



HOW TO STAPLE MANUALLY

You can perform stapling manually.
Make sure the manual staple key is lit green.

1

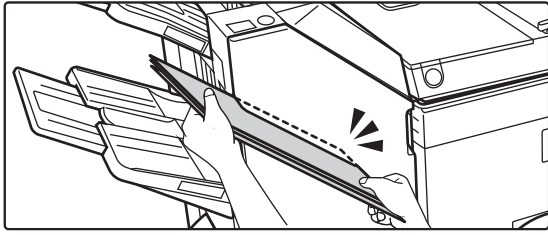

Place the paper that you want to staple in the insertion slot.

When you place the paper, the manual staple key blinks green.

After two seconds elapse, stapling automatically starts.



- To staple earlier than the auto staple start time, press the manual staple key.

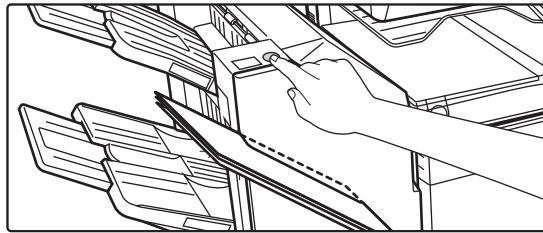

- Manual stapling cannot be executed during execution of a staple job.

Relation between paper orientation and stapling result

Paper	Paper orientation when inserted	After stapling



SUPPLIES

The saddle stitch finisher (large stacker) requires the following staple cartridge:

Finisher unit

Staple cartridge (approx. 5000 staples per cartridge x three cartridges)
MX-SC11

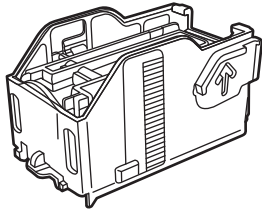

Saddle stitch unit

Staple cartridge (approx. 2000 staples per cartridge x four cartridges)
MX-SC12

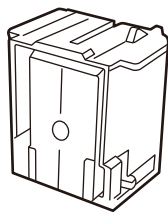

SADDLE STITCH FINISHER (LARGE STACKER) MAINTENANCE

When the staple cartridge runs out of staples, a message will appear in the operation panel. Follow the operation procedure to replace the staple cartridge.

Replacement the staple cartridge (finisher unit)

1

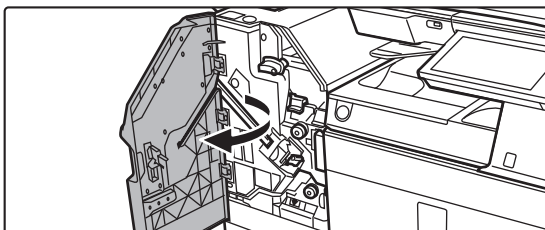

Open the front upper cover.



2

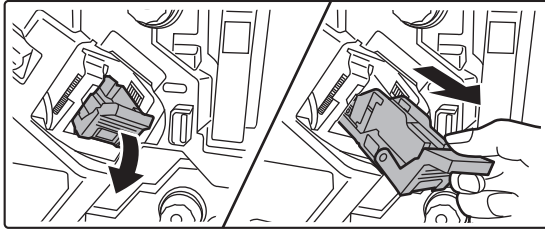

Remove the staple case.

3

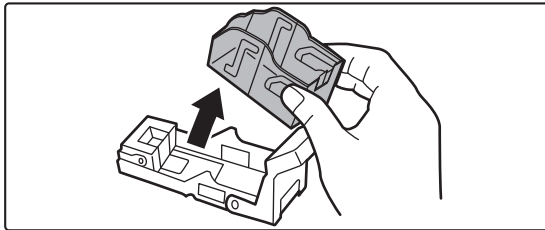

Remove the empty staple cartridge.

4

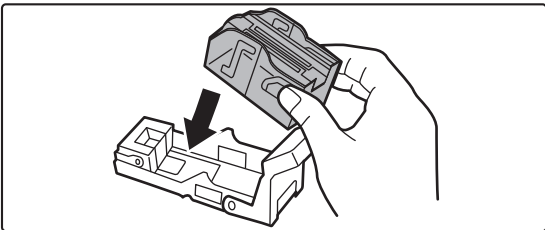

Insert a new staple cartridge into the staple case.

Push the staple cartridge in until it clicks into place.

5

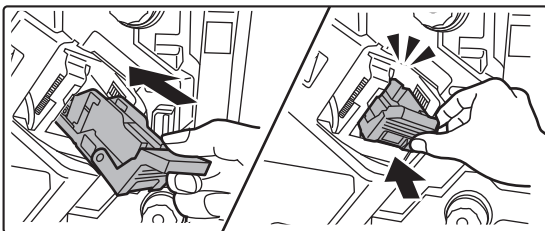

Push the staple case firmly back in.

Push the staple case in until it clicks into place.

6

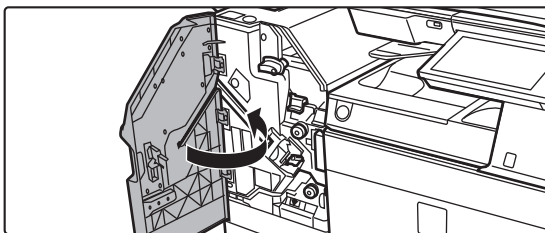

Close the front upper cover.



Make a proof copy in staple sort function to verify that stapling takes place correctly.



Replacement the staple cartridge (saddle stitch unit)

Before starting this procedure, remove all output from the output tray of the saddle finisher (large stacker). Do not replace removed output back in the output tray.

1

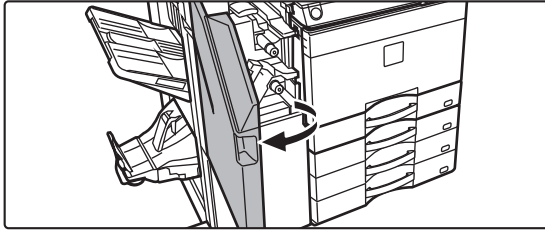

Open the front upper cover.

2

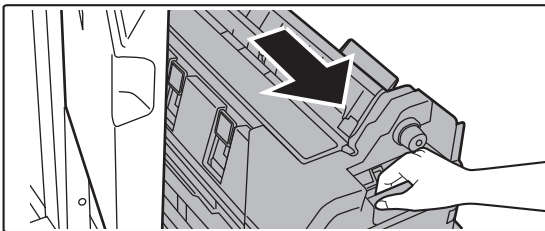

Slowly pull out the front lower cover until it stops.

3

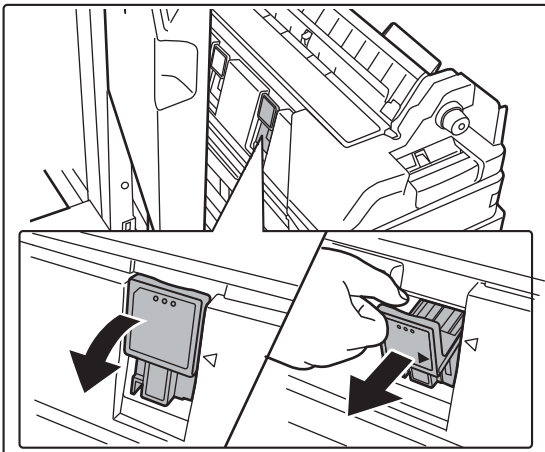

Remove the staple case.

4

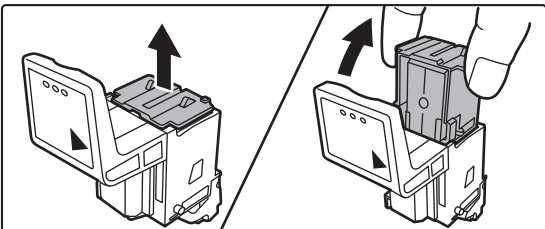

Remove the empty staple cartridge.



5

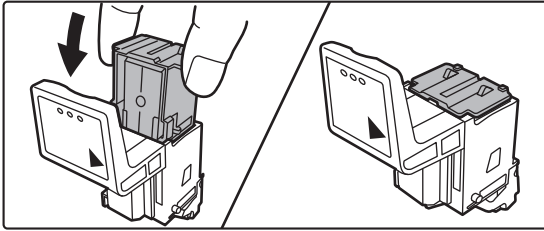

Insert a new staple cartridge into the staple case.

Replace both staple cartridges.

6

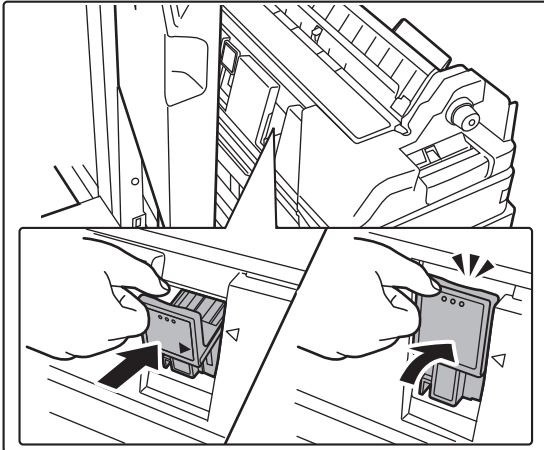

Push the staple case firmly back in.

Push the staple case in until it clicks into place.

7

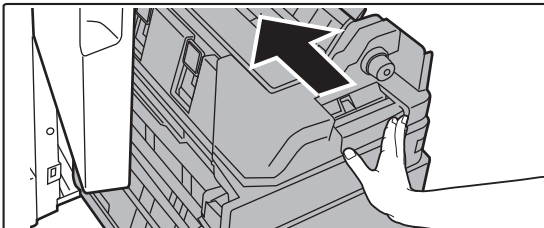

Push the front lower cover back in.

8



Close the front upper cover.



Make a test print or copy using the saddle stitch function to verify that stapling takes place correctly.



PUNCH MODULE

The punch module can be installed on an inner finisher, finisher or saddle stitch finisher to punch holes in paper to be output.

DISCARDING PUNCH WASTE

Punch waste from punched holes is collected in the punch waste box. Follow the operation procedure to replace punch waste.

Inner finisher installed

1

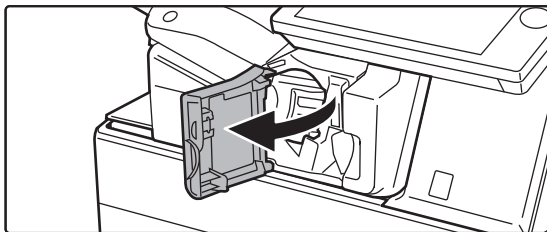

Open the finisher front cover.

2

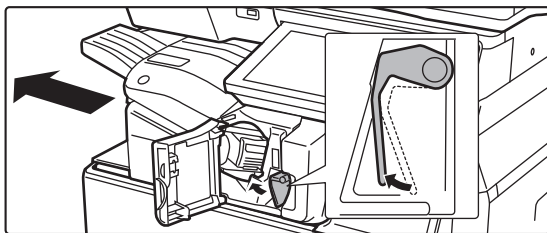

While pressing the lever over to the left, slide the finisher to the left until it stops.

3

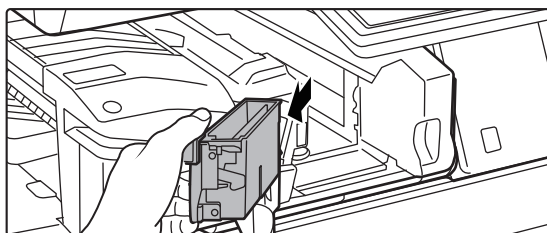

Grasp the punch waste box handle, gently pull out the box, and discard the punch waste.

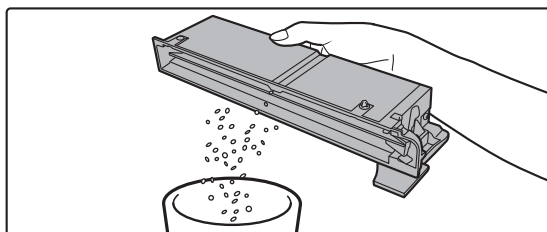



4

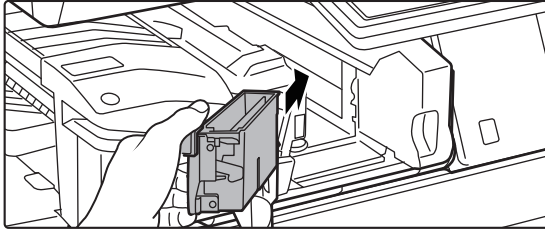

Replace the punch waste box.

If the punch waste box is not replaced properly, printing will not be possible to use the punch function.

5

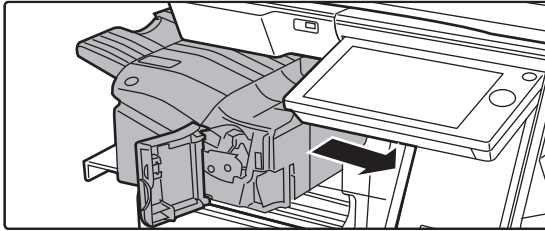

Slide the finisher to the right until it stops.

6

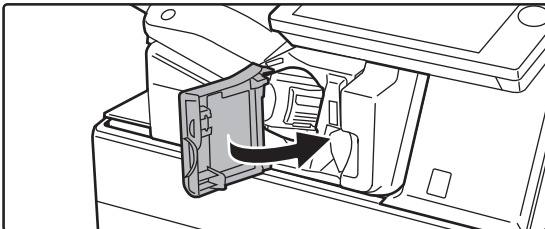

Close the finisher front cover.



Finisher installed

1

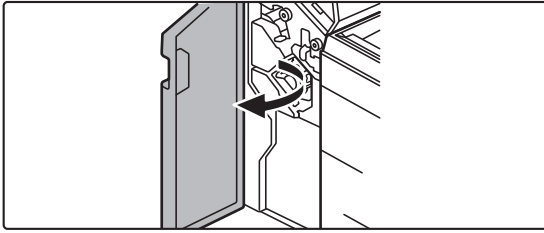

Open the front cover.

2

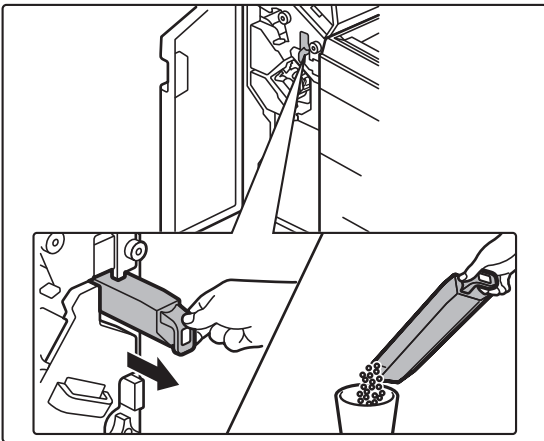

Pull out the punch waste box and discard the punch waste.

3

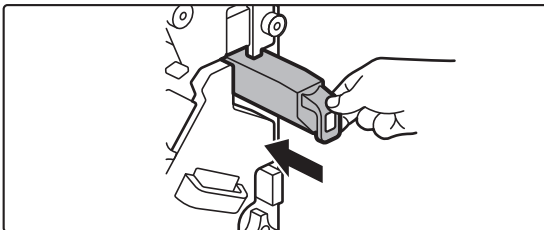

Replace the punch waste box.

If the punch waste box is not replaced properly, printing will not be possible to use the punch function.

4

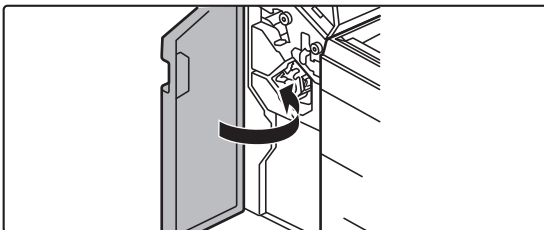

Close the front cover.



Finisher (large stacker) installed

1

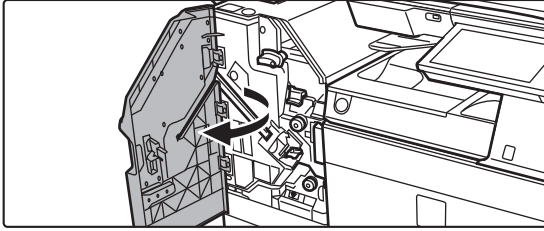

Open the front cover.

2

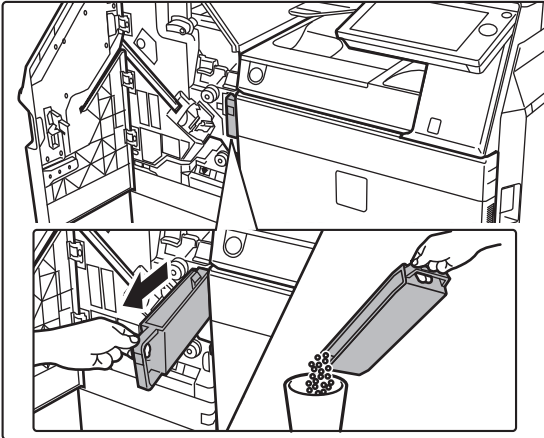

Pull out the punch waste box and discard the punch waste.

3

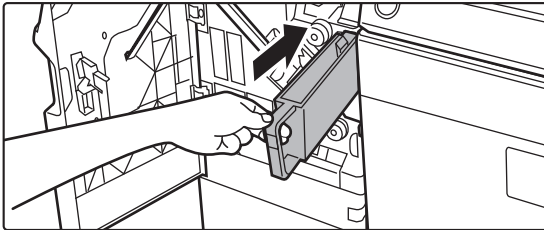

Replace the punch waste box.

If the punch waste box is not replaced properly, printing will not be possible to use the punch function.

4

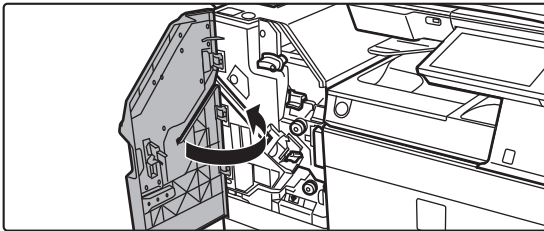

Close the front cover.



Saddle stitch finisher installed

1

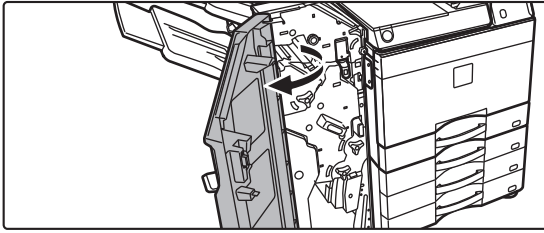

Open the front cover.

2

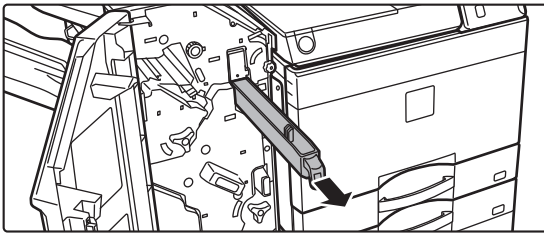

Pull out the punch waste box and discard the punch waste.

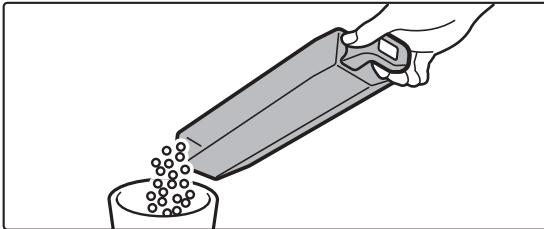

3

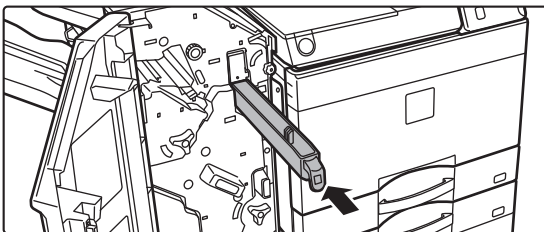

Replace the punch waste box.

If the punch waste box is not replaced properly, printing will not be possible to use the punch function.

4

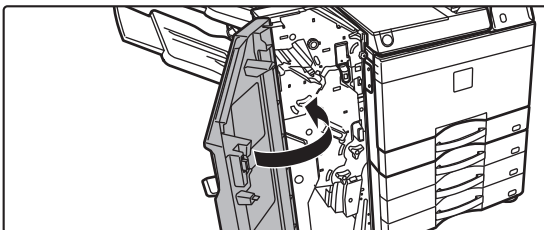

Close the front cover.



Saddle stitch finisher (large stacker) installed

1

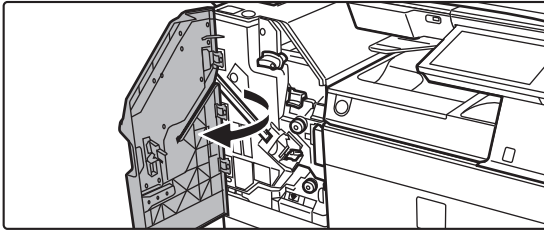

Open the front cover.

2

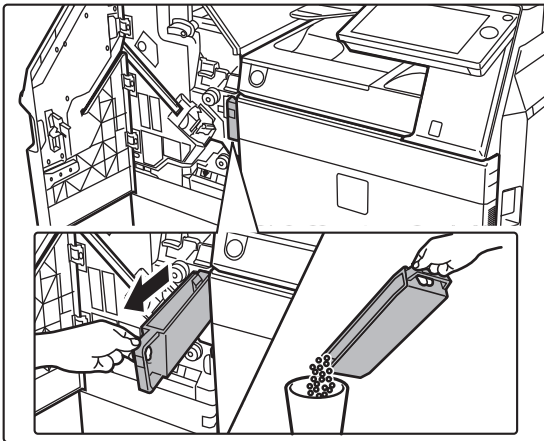

Pull out the punch waste box and discard the punch waste.

3

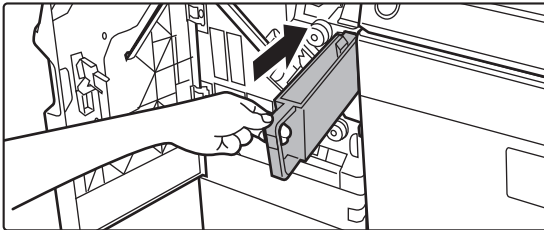

Replace the punch waste box.

If the punch waste box is not replaced properly, printing will not be possible to use the punch function.

4

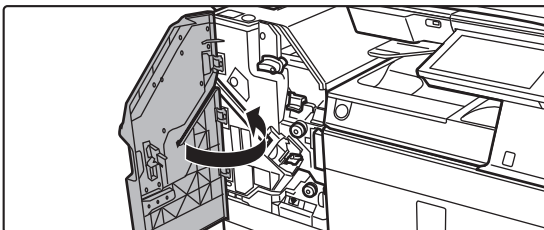

Close the front cover.



Sharp OSA

Sharp OSA (Open Systems Architecture) is an architecture that directly links the machine to software applications for work (external applications) over a network.

When you use a machine that supports Sharp OSA, you can link controls on the operation panel and device functions such as scan send to external applications.

APPLICATION COMMUNICATION

This module enables you to link the machine with a scanner application and other standard applications. Set a standard application in "Settings (administrator)" and "Sharp OSA".



In order to use this function, the Application Communication Module (MX-AMX2) is required in some countries and regions.



To set a standard application in "Settings (administrator)":

In "Settings (administrator)", select [System Settings] → [Sharp OSA Settings] → [Standard Application Settings].

1

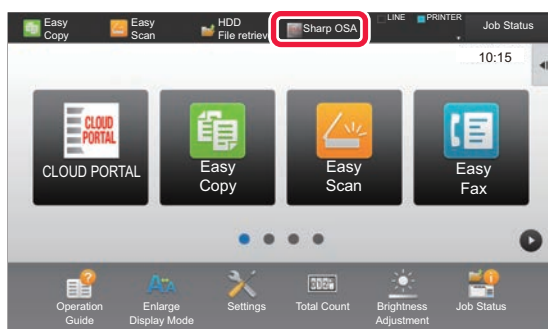

Tap the [Sharp OSA] key in the Home screen.

If no standard applications have been stored, the key cannot be tapped.

2

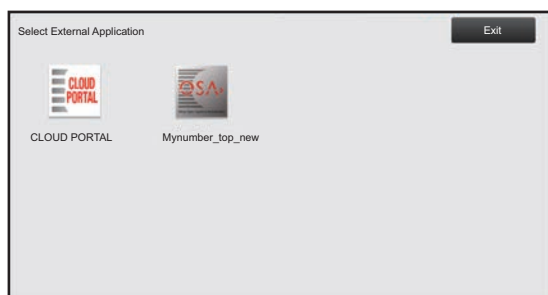

Select a standard application.

If two or more standard applications have been stored, the screen for selecting a standard application will appear. Tap the standard application that you wish to use.

If only one standard application has been stored, connection to the standard application will begin.

3

Connect the machine to the standard application.

The message "Connecting to the external application." appears while the machine communicates with the standard application.



EXTERNAL ACCOUNT APPLICATION

The external account module enables you to use an "external account application" for centralized account management of an MFP on a network.

An "external account application" can be used in "external authentication mode" or "external count mode". When "external authentication mode" is used, the login screen is retrieved from the application when the machine is started. When a job ends, a job notification screen is sent to the application for counts by authenticated user. When "external count mode" is used, the login screen is not displayed when the machine is started. Only a job result notification is sent to the application. User authentication by the external account application cannot be used. However, the external account application can be used in combination with the internal account function.



In order to use this function, the External account module (MX-AMX3) is required in some countries and regions.

External account application setup

After setting an external application in "Settings (administrator)", restart the machine to enable the setting. To restart the machine, see "[TURNING ON THE POWER \(page 1-10\)](#)".



To set up the external account application:

In "Settings (administrator)", select [System Settings] → [Sharp OSA Settings] → [External Accounting Application Settings].

Operation in external account mode

The following describes operation in the two modes for using an external account application.

External authentication mode

When the machine is powered on in external authentication mode, the machine accesses the external account application and displays the login screen. The login screen also appears when the [Call] key is tapped to run a job in the job status complete screen. (The login screen does not appear if the user has already logged in by the normal method.) Tap the job status display while the login screen is displayed, and the Job Status screen appears. To return to the previous screen, tap a mode select key.



To enable the external authentication mode:

In "Settings (administrator)", select [System Settings] → [Sharp OSA Settings] → [External Accounting Application Settings] and enable the [External Account Control] setting.



- The user control function of the machine cannot be used in external authentication mode. However, "User Registration", "User Count Display", "User Count Reset", "User Information Print", and "The Number of User Name Displayed Setting" can be used.
- The mode select key cannot be used while the login screen appears.

If login fails:

If the login screen fails to appear or the application does not operate correctly, the machine may also stop operating correctly. In that case, terminate external account mode forcibly.



To forcibly terminate the external account mode:

In "Settings (Web version)", select [System Settings] → [Sharp OSA Settings] → [External Accounting Application Settings]. If termination in Setting mode (Web version) fails, terminate it forcibly on the operation panel of the machine.

In "Settings", select [System Settings] → [Sharp OSA Settings] and change the setting for [External Accounting Application Settings] and then restart the machine. To restart the machine, see "[TURNING ON THE POWER \(page 1-10\)](#)".



External count mode

Unlike in external authentication mode, when the machine is started in "external count mode", the login screen of the external account application is not displayed after the machine has started up. Only the job result is sent to the external account application.

External count mode can be used together with the user control function of the machine. (External count mode can also be used when the user control function is disabled.)



To enable the external count mode:

In "Settings (administrator)", select [System Settings] → [Sharp OSA Settings] → [External Accounting Application Settings] and enable the [External Account Control] setting alone.



REMOVING MISFEEDS

REMOVING MISFEEDS

If a paper misfeed occurs, the "Paper Jam" message will appear in the touch panel and printing and scanning will stop. In this event, tap the [Check how to remove misfeeds] key in the touch panel.

When the key is tapped, instructions for removing the misfeed will appear. Follow the instructions. When the misfeed is cleared, the message will automatically disappear.

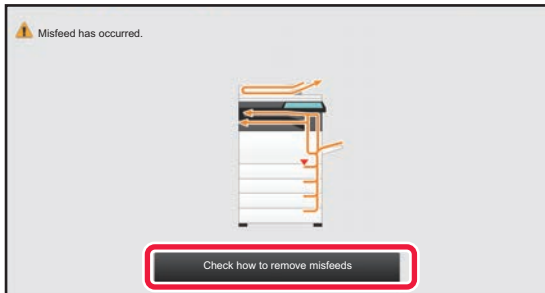

- The fusing unit and paper output area are hot.
- When removing a misfeed, do not touch the fusing unit. You may burn yourself.

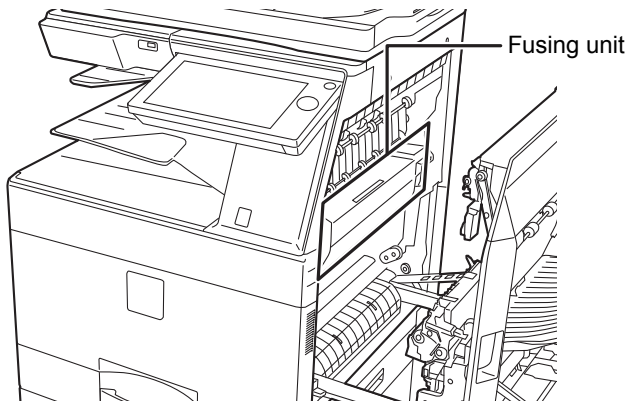



MAINTENANCE

This section explains how to clean the machine, replace the toner cartridge, the waste toner box, and the stamp cartridge.

REGULAR MAINTENANCE

To ensure that the machine continues to provide top quality performance, periodically clean the machine.



Do not use a flammable spray to clean the machine. If gas from the spray comes in contact with hot electrical components or the fusing unit inside the machine, fire or electrical shock may result.



- Do not use thinner, benzene, or similar volatile cleaning agents to clean the machine. These may degrade or discolour the housing.
- Use a soft cloth to gently wipe off dirt from the area on the operation panel with a mirror-like finish (shown at right). If you use a stiff cloth or rub hard, the surface may be damaged.

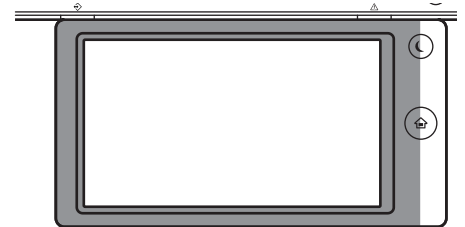

The area with a mirror-like finish is the area that is 

CLEANING THE DOCUMENT GLASS AND AUTOMATIC DOCUMENT FEEDER

If the document glass or document backplate sheet becomes dirty, the dirt will appear as dirty spots, coloured lines, or white lines in the scanned image. Keep these parts clean at all times.

Wipe the parts with a clean, soft cloth.

If necessary, moisten the cloth with water or a small amount of neutral detergent. After that, wipe with a clean dry cloth.

Examples of lines in the image

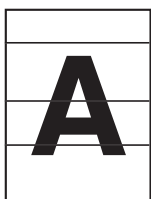

Black lines



White lines

Document glass

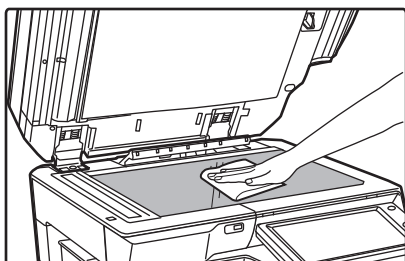

Document backplate sheet

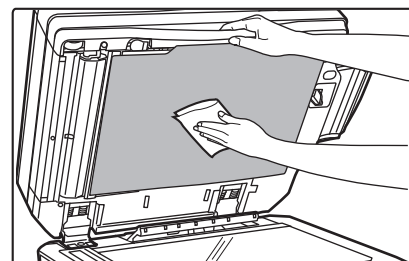



SCANNING AREA

If black lines or white lines appear in images scanned using the automatic document feeder, clean the scanning area (the thin long glass next to the document glass).

To clean this part, use the glass cleaner that is stored in the automatic document feeder. After using the glass cleaner, be sure to return it to its storage position.

When using the MX-3070V/MX-3570V/MX-4070V/MX-5070V/MX-6070V

1

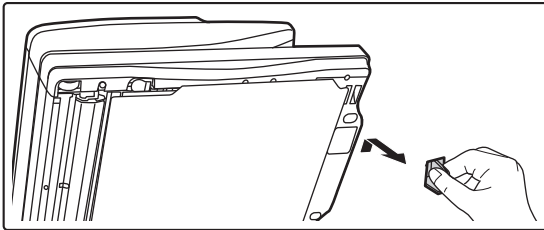

Open the automatic document feeder and remove the glass cleaner.

2

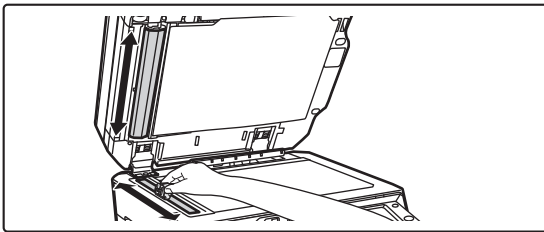

Clean the document scanning area on the document glass with the glass cleaner.

One scanning area is on the document glass and the other is inside the automatic document feeder.

3

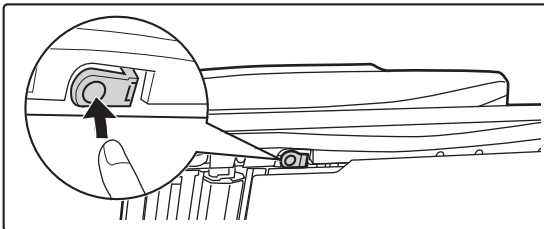

Open the scanning area cover on the automatic document feeder.

Push in the release switch to release the cover.

4

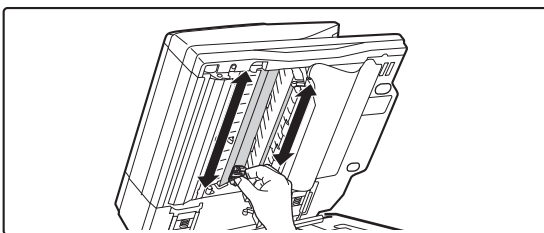

Clean the scanning area in the automatic document feeder.

5

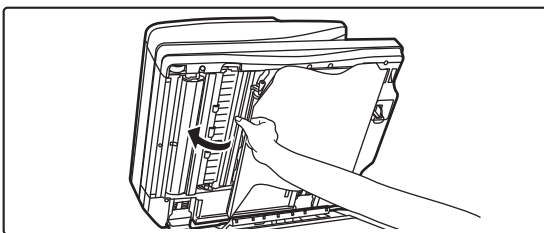

Close the cover.



6

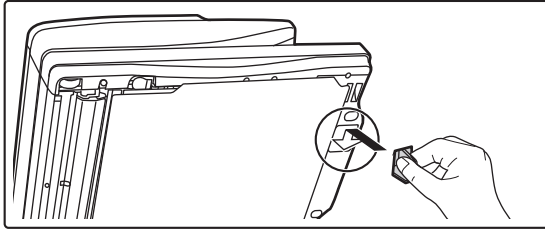

Replace the glass cleaner.

When using the MX-2630N/MX-3050V/MX-3060V/MX-3550V/MX-3560V/MX-4050V/MX-4060V/MX-5050V/MX-6050V

1

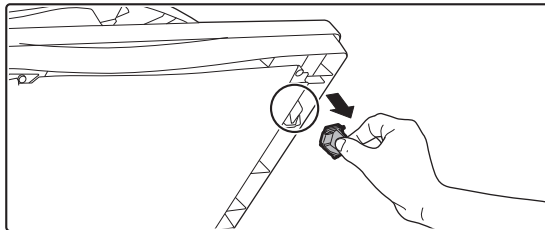

Open the automatic document feeder and remove the glass cleaner.

2

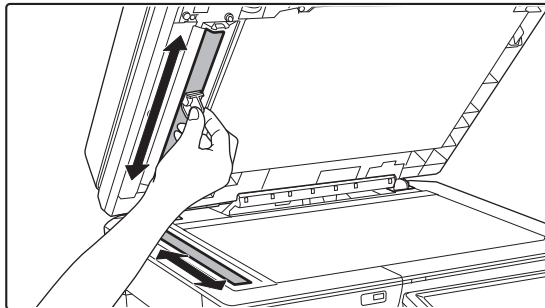

Clean the document scanning area on the document glass with the glass cleaner.

3

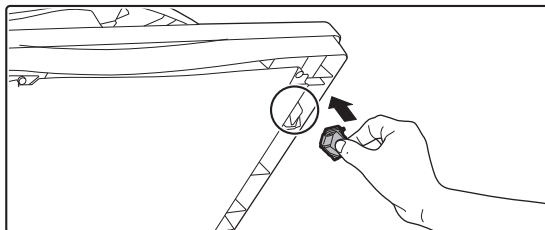

Replace the glass cleaner.



CLEANING THE MAIN CHARGER OF THE PHOTOCONDUCTIVE DRUM

If black lines or coloured lines appear even after you have cleaned the document glass and automatic document feeder, use the charger cleaner to clean the main charger that charges the photoconductive drum.



The charger is automatically cleaned on the MX-5050V/MX-5070V/MX-6050V/MX-6070V. The charger cleaner cannot be used.

► [MC Cleaning Mode \(MX-5050V/MX-5070V/MX-6050V/MX-6070V only\) \(page 7-173\)](#)

MX-2630N/MX-3050V/MX-3070V/MX-3550V/MX-3570V/MX-4050V/MX-4070V only

1

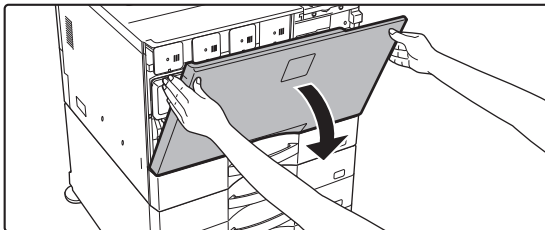

Open the front cover.

2

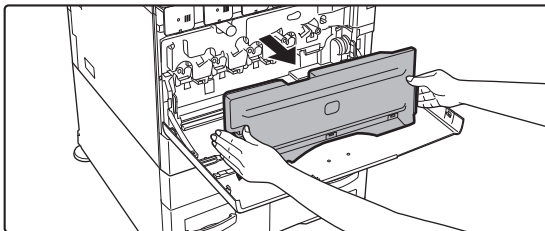

Remove the waste toner box.

Press the release buttons on the sides of the waste toner box inward and pull out slowly.

3

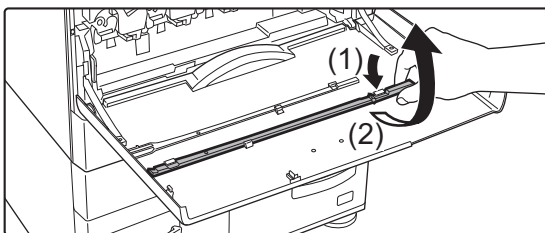

Remove the charger cleaner.

The charger cleaner is attached to the front cover.

(1) **Pull the right-hand side of the charger cleaner to detach it from the hook.**

(2) **Put it over the hook to place it on the back side.**

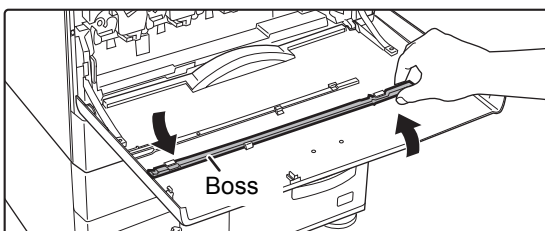

(3) **Turn the charger cleaner around the boss to detach it from the left hand hook.**



4

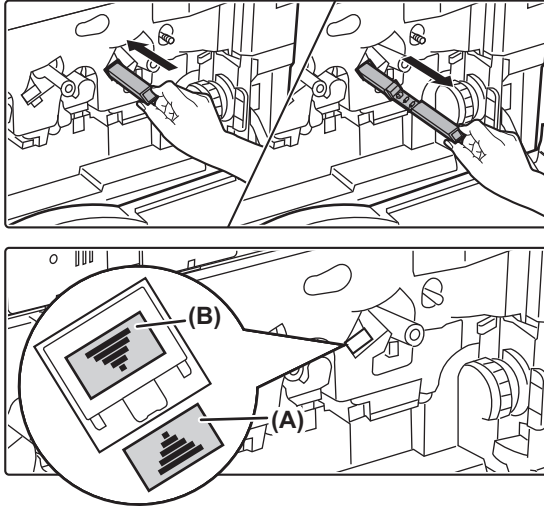

Clean the main charger.

- (1) Gently push the charger cleaner all the way in.
 - (2) Gently remove the charger cleaner.
- Insert it so that label (A) on the cleaning target side and label (B) on the charger cleaner side are oriented as shown.

5

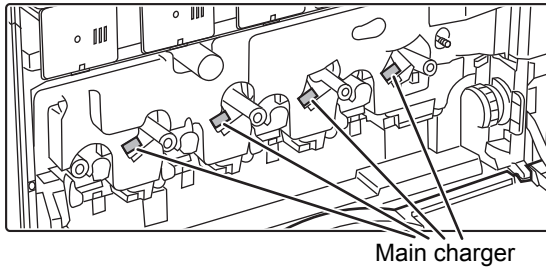

Repeat step 4 with all other main chargers.

There are a total of 4 places to be cleaned in the machine as shown.

6

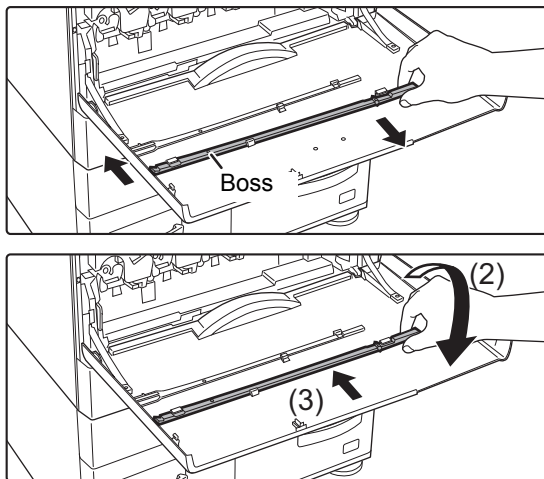

Replace the charger cleaner in its original position.

- (1) Fit the charger cleaner onto the boss and rotate. Hook the end (without a handle) onto the left hook.
- (2) Put the right-hand side of the charger cleaner over the hook to place it on the near side.
- (3) Turn the charger cleaner onto hook.

7

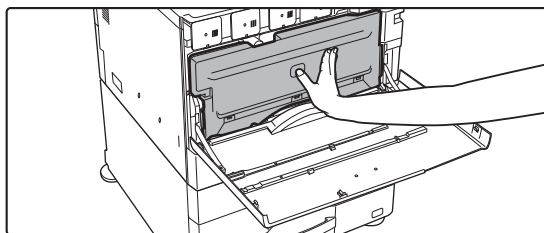

Push the waste toner box into the machine.

Push in until you hear a "click" sound indicating that the left and right locks are engaged.



8

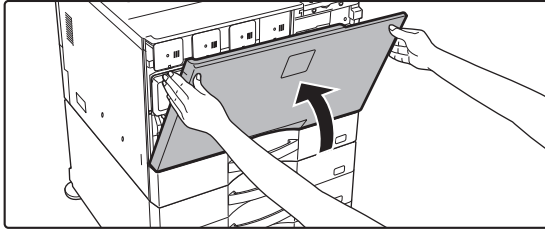

Close the front cover.



- If the problem persists after you perform these steps, repeat the cleaning procedure going back and forth about 3 times.
- When pulling and pushing the knob to clean the charger, pull and push the knob slowly from one end to the other.



CLEANING THE PT CHARGER OF THE PRIMARY TRANSFER BELT

If black lines or coloured lines appear even after you have cleaned the document glass, automatic document feeder and main charger, use the PT charger cleaner to clean the PT charger.

1

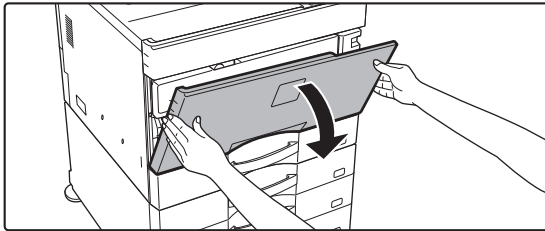

Open the front cover.



When a finisher (large stacker) or saddle stitch finisher (large stacker) is installed on the MX-5050V/MX-5070V/ MX-6050V/MX-6070V, open the front cover on the finisher (large stacker), or the front upper cover on the saddle stitch finisher (large stacker), before opening the front cover of the machine.

2

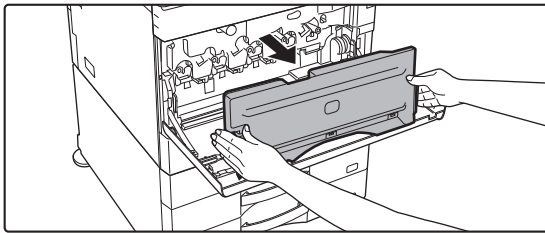

Remove the waste toner box.

Press the release buttons on the sides of the waste toner box inward and pull out slowly.

3

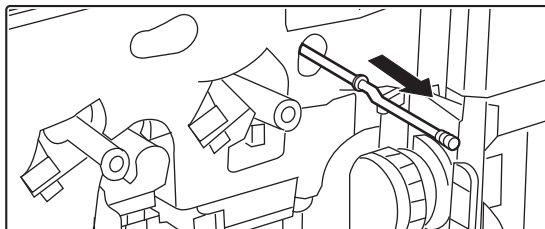

Clean the PT charger.

(1) Withdraw the PT charger slowly until you feel resistance.

(2) Gently push the PT charger cleaner all the way in.

(3) Repeat (1) and (2) above three times.

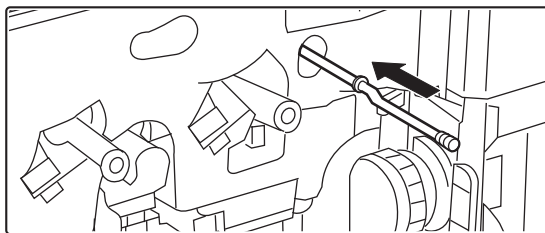

4

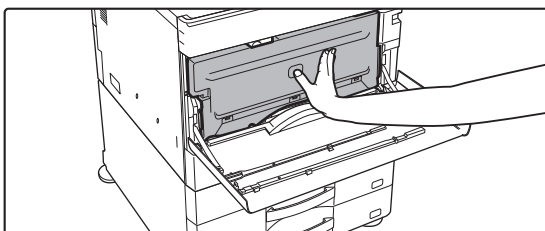

Push the waste toner box into the machine.

Push in until you hear a "click" sound indicating that the left and right locks are engaged.



5

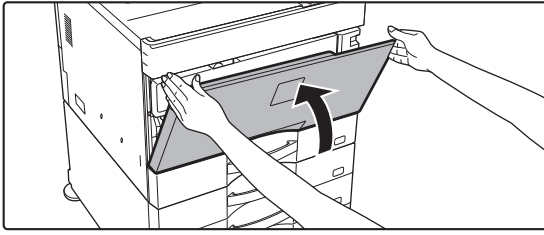

Close the front cover.



CLEANING THE LASER UNIT

When the laser unit inside the machine becomes dirty, line patterns (coloured lines) may form in the printed image.

Identifying lines (coloured lines) caused by a dirty laser unit

- Coloured lines always appear in the same place. (The lines are never black.)
- Coloured lines appear in parallel with the direction of paper feeding.
- Coloured lines appear not only on output from a copier but also on prints from a computer. (The same lines appear on both copies and print jobs.)

If conditions similar to the above occur, clean the laser unit as explained below.

1

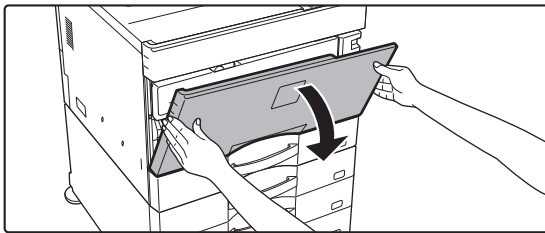

Open the front cover.



When a finisher (large stacker) or saddle stitch finisher (large stacker) is installed on the MX-5050V/MX-5070V/ MX-6050V/MX-6070V, open the front cover on the finisher (large stacker), or the front upper cover on the saddle stitch finisher (large stacker), before opening the front cover of the machine.

2

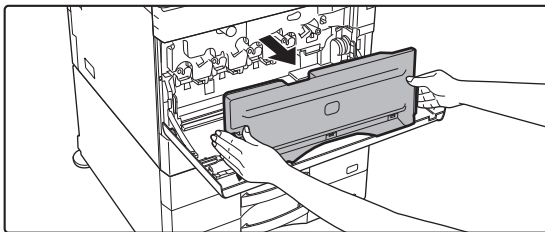

Remove the waste toner box.

Press the release buttons on the sides of the waste toner box inward and pull out slowly.

3

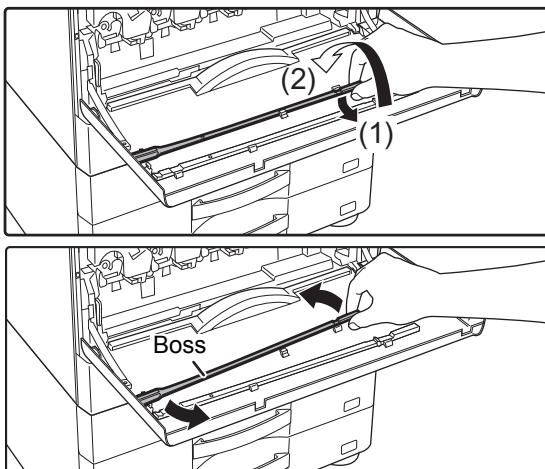

Take out the cleaning tool for the laser unit.

The cleaning tool is attached to the front cover.

- (1) Pull the right-hand side of the cleaning tool to detach it from the hook.
- (2) Put it over the hook to place it on the back side.
- (3) Turn the cleaning tool around the boss to detach it from the left hand hook.



4

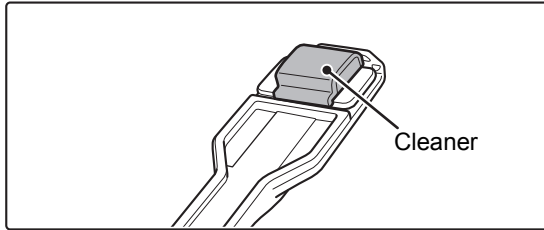

Make sure that the cleaner at the tip of the cleaning tool is not dirty.

If the cleaner is dirty, remove the cleaner from the cleaning tool and replace it with a clean one. For the procedure for replacing the cleaner, see steps 5 through 7. If the cleaner is not dirty, go to step 8.

5

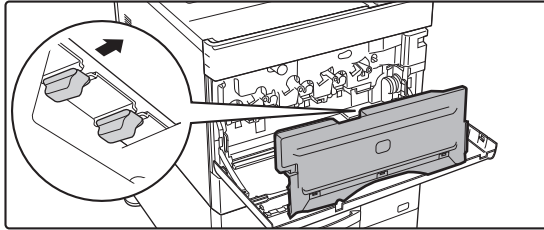

Take out a replacement cleaner from the waste toner box.

Replacement cleaners are stored on the waste toner box. Grasp the end of the cleaner and pull it out of the waste toner box.

6

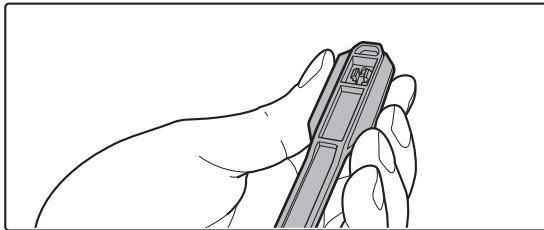

Remove the dirty cleaner from the tip of the cleaning tool.

- (1) Firmly grasp the tool where the cleaner is attached.
- (2) Use your other hand to press down on the hook that secures the cleaner, and remove the cleaner.

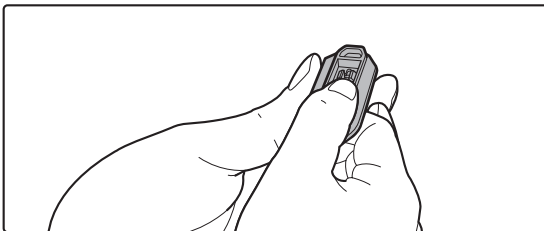

Put the removed cleaner back on the waste toner box.

7

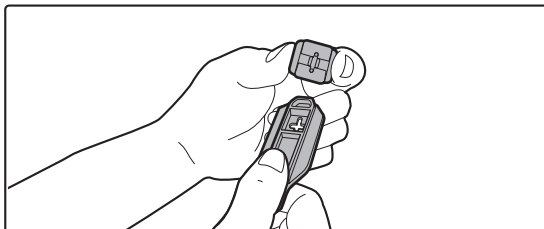

Attach the new cleaner to the cleaning tool.

- (1) Align the cleaner hook with the attachment hole in the cleaning tool.
- (2) Hold the cleaner firmly and push the cleaning tool in.

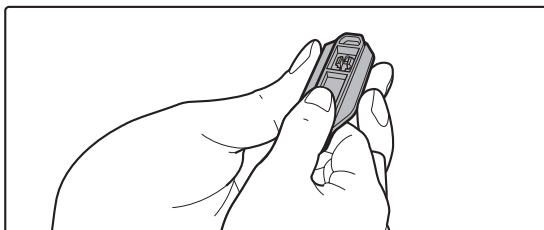

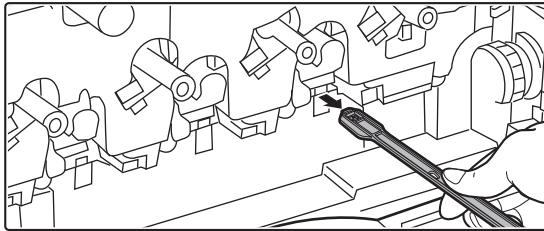
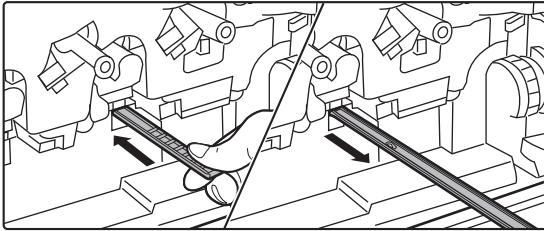
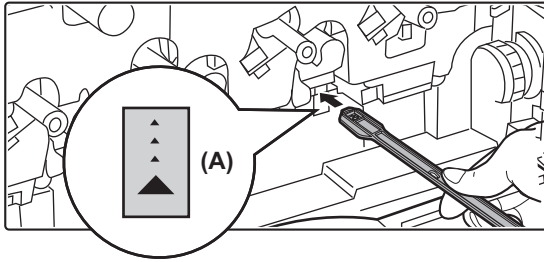

8

**Clean the laser unit.**

- (1) Point the cleaner down and slowly insert the tool into the hole that you wish to clean.**

Be sure to point the cleaner down.
Labels similar to (A) are attached to areas that require cleaning.

- (2) Insert the cleaning tool all the way into the hole and then pull it back out.**

Pull the cleaning tool out until you feel the tip of the tool leave the cleaning surface of the laser unit.

- (3) Repeat step 2 two or three times and then remove the cleaning tool.**

9

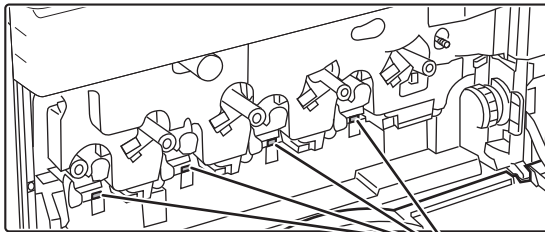

Cleaning locations

Repeat steps 8 to clean all holes (4 holes) in the laser unit.

The laser unit is cleaned in four locations, including the location cleaned in step 8. Clean all holes.

10

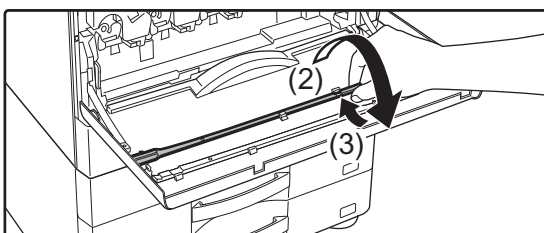
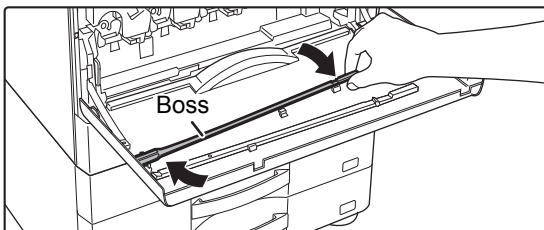
**Replace the cleaning tool.**

- (1) Engage the cleaning tool onto the boss and turn it around it, and then put the edge (the cleaner side) on the left hand hook.**
- (2) Put the right-hand side of the cleaning tool over the hook to place it on the near side.**
- (3) Turn the cleaning onto hook.**



11

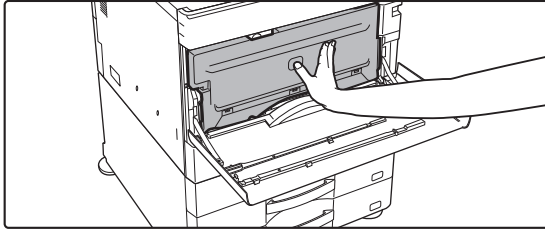

Push the waste toner box into the machine.

Push in until you hear a "click" sound indicating that the left and right locks are engaged.

12

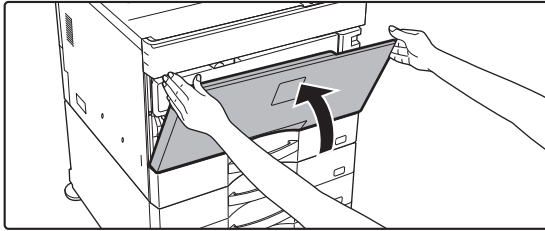

Close the front cover.

CLEANING THE BYPASS FEED ROLLER

If paper misfeeds frequently occur when feeding envelopes or heavy paper through the bypass tray, wipe the surface of the feed roller with a clean soft cloth moistened with water or a neutral detergent.

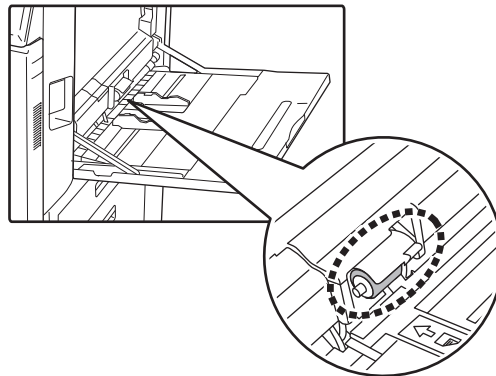

CLEANING THE PAPER FEED ROLLER (MX-2630N/MX-3050V/MX-3060V/MX-3550V/MX-3560V/ MX-4050V/MX-4060V/MX-5050V/MX-6050V only)

If lines or other dirt appear on the scanned original when the automatic document feeder is used, wipe the surface of the roller with a clean soft cloth moistened with water or a neutral detergent.

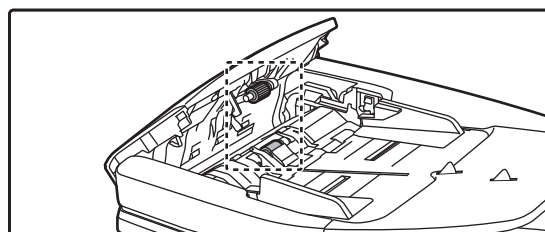



REPLACEMENT OF TONER CARTRIDGE

Always replace the toner cartridge after the "Change the toner cartridge." message appears. You should keep one set of replacement toner cartridges on hand so that you can replace a toner cartridge immediately when toner runs out.



On the MX-5050V/MX-5070V/MX-6050V/MX-6070V, you can replace a toner cartridge without stopping printing.

Replacement message

When using the MX-5050V/MX-5070V/MX-6050V/MX-6070V

Toner Low. (□□□□)(Do not replace cartridge until requested.)

When this message appears, prepare a toner cartridge for replacement. "(□□□□)" indicates the colour of toner cartridge that must be readied.



If you continue printing, the following message appears.

When this message appears, prepare a toner cartridge for replacement and replace it.

Ready to scan for copy.
(□□□□ Change the toner supply.)



If you continue to use the machine, the following message will appear when the toner runs out.

Colours that have run out of toner are indicated in (□□□□).

Y: Yellow toner, M: Magenta toner, C: Cyan toner, and Bk: Black toner

Replace the toner cartridge with a one of the relevant colour.

Change the toner cartridge.(□□□□)

When using the MX-2630N/MX-3050V/MX-3060V/MX-3070V/MX-3550V/MX-3560V/MX-3570V/ MX-4050V/MX-4060V/MX-4070V

Toner Low. (□□□□)(Do not replace cartridge until requested.)

When this message appears, prepare a toner cartridge for replacement.

"(□□□□)" indicates the colour of toner cartridge that must be readied.



If you continue to use the machine, the following message will appear when the toner runs out.

Colours that have run out of toner are indicated in (□□□□).

Y: Yellow toner, M: Magenta toner, C: Cyan toner, and Bk: Black toner

Replace the toner cartridge with a one of the relevant colour.

Change the toner cartridge.(□□□□)



1

When using the MX-5050V/MX-5070V/MX-6050V/MX-6070V

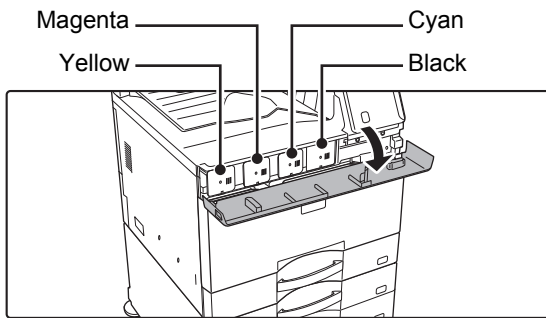

Open the toner cover.

When using the MX-2630N/MX-3050V/MX-3060V/MX-3070V/MX-3550V/MX-3560V/MX-3570V/MX-4050V/
MX-4060V/MX-4070V

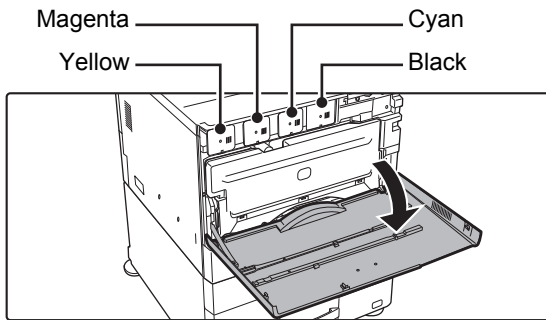

Open the front cover.

2

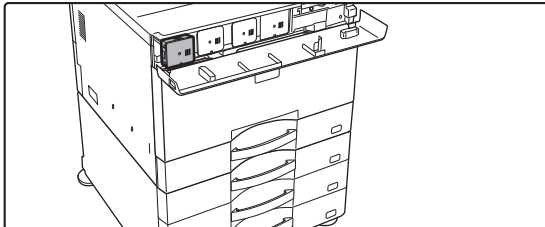

Pull the toner cartridge toward you.

The empty toner cartridge is ejected forward to enable removal.

Gently pull out the toner cartridge horizontally.

If the cartridge is pulled out abruptly, toner may spill out.

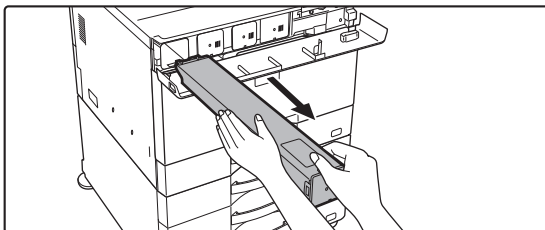

(Example) Replacing the yellow toner cartridge

Hold the toner cartridge with both hands as shown and slowly pull it out of the machine.



Do not attempt to remove a toner cartridge that has not been ejected.



3

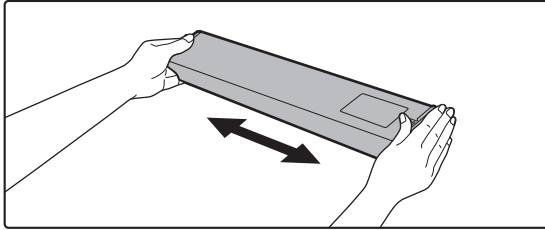

Take out a new toner cartridge from its package and shake it horizontally five or six times.

4

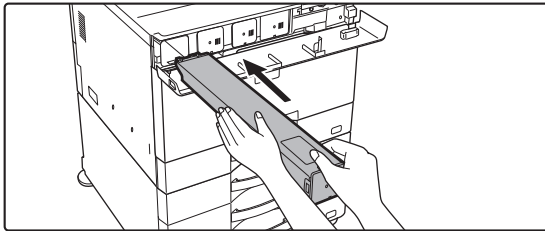

Slowly insert the new toner cartridge on the level.



A toner cartridge of a different colour cannot be installed. Be sure to install a toner cartridge of the same colour.

5

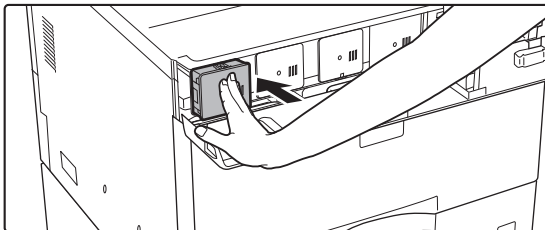

Press in firmly until you hear a "click" sound

6

When using the MX-5050V/MX-5070V/MX-6050V/MX-6070V

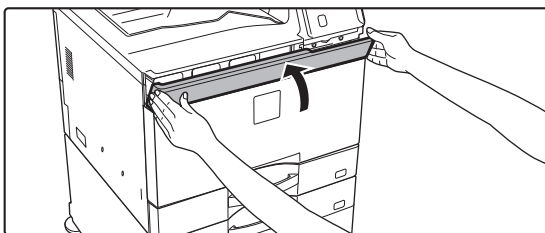

Close the toner cover.

When using the MX-2630N/MX-3050V/MX-3060V/MX-3070V/MX-3550V/MX-3560V/MX-3570V/MX-4050V/MX-4060V/MX-4070V

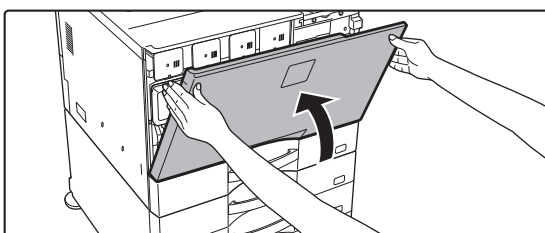

Close the front cover.

After the toner cartridge is replaced, the machine automatically enters image adjustment mode. Do not open the front cover while this is occurring.



- Do not throw a toner cartridge into a fire. Toner may fly and cause burns.
- Store toner cartridges out of reach of small children.
- If a toner cartridge is stored upright, the toner may harden and become unusable. Always store toner cartridges on their side.
- If a toner cartridge other than a SHARP-recommended toner cartridge is used, the machine may not attain full quality and performance and there is a risk of damage to the machine. Be sure to use a SHARP-recommended toner cartridge.



- If any one of the toner colours runs out, colour printing will no longer be possible. If the Y, M, or C toners run out but a quantity of Bk toner still remains, printing is performed in black and white.
- Depending on your conditions of use, the colour may become light or the image blurred.



- Be sure to install four toner cartridges (Y/M/C/Bk).
- Your service technician will collect used toner cartridges.
- To view the approximate amount of toner remaining (indicated in %), hold down the [Home Screen] key during printing or in standby mode. When the percentage falls to "25-0%", keep a toner cartridge for replacement purposes before toner runs out.
- When toner runs out while the home screen is displayed, the "Toner Empty" message appears in the upper right corner of the screen.



To manually remove the toner cartridge

Set the toner cartridge to be removed with "Settings (administrator)" → [System Settings] → [Image Quality Adjustment] → [Remove Toner Cartridge].

For more information, see "[Remove Toner Cartridge \(page 7-176\)](#)".



REPLACING THE WASTE TONER BOX

The waste toner box collects excess toner that is produced during printing. When the waste toner box becomes full, the message "Replace waste toner box." will appear.

When this message appears, tap the guidance key that appears on the touch panel to view the procedure for replacing the waste toner box.

When the key is tapped, instructions for replacing the waste toner box will appear. Follow the instructions. When the waste toner box is replaced, the message will automatically disappear.



When a finisher (large stacker) or saddle stitch finisher (large stacker) is installed on the MX-5050V/MX-5070V/MX-6050V/MX-6070V, open the front cover on the finisher (large stacker), or the front upper cover on the saddle stitch finisher (large stacker), before opening the front cover of the machine.



- Do not throw the waste toner box into a fire. Toner may fly and cause burns.
- Store the waste toner box out of the reach of small children.



REPLACING THE STAMP CARTRIDGE

If a stamp unit (AR-SU1) is installed on the automatic document feeder and the stamp has become light, replace the stamp cartridge (AR-SV1).

Supplies

Stamp cartridge (2 in package) AR-SV1

When using the MX-3070V/MX-3570V/MX-4070V/MX-5070V/MX-6070V

1

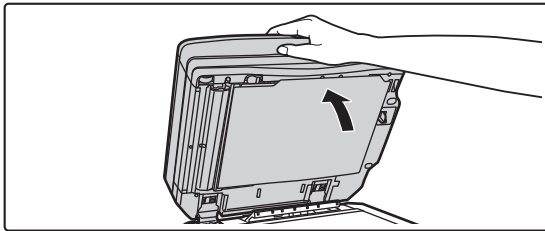

Open the automatic document feeder.

2

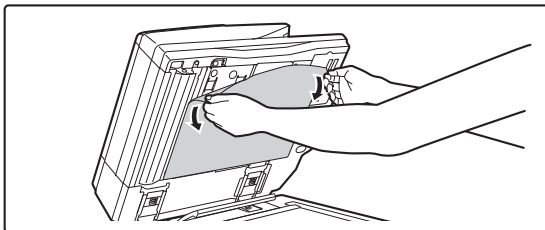

Remove the document backplate sheet from the automatic document feeder.

Remove the sheet slowly. Place the removed sheet with the side that was attached face up on the document glass.

3

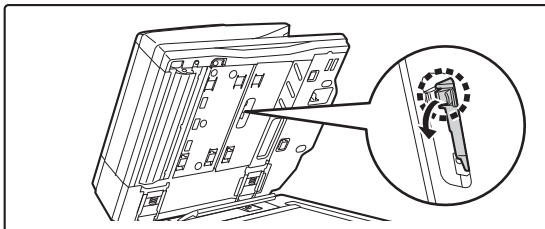

Grasp the tab on the stamp unit and pull the unit out.

4

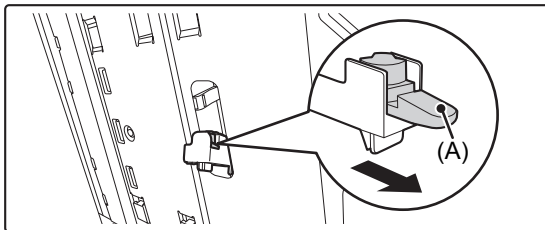

Remove the stamp cartridge (A).



5

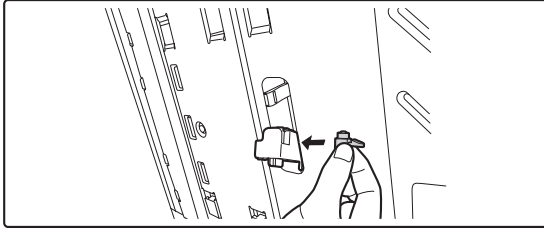

Install a new stamp cartridge.

6

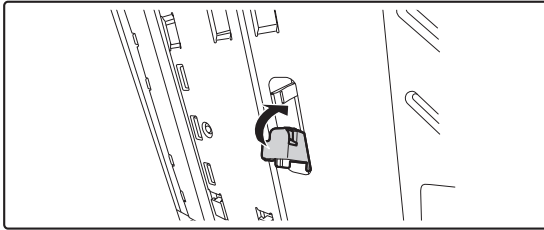

Push the stamp unit back in.

Push the stamp unit in until it clicks into place.

7

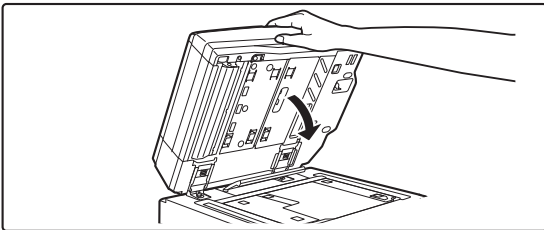

Close the automatic document feeder to attach the document backplate sheet.

When the automatic document feeder is closed, the document backplate sheet on the document glass attaches to the automatic document feeder.

8

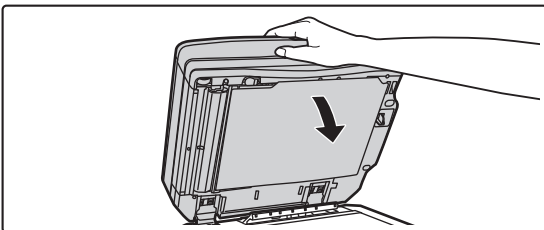

Make sure that the document backplate sheet is firmly attached to the automatic document feeder and then close the automatic document feeder.

If the document backplate sheet is not firmly attached, remove the sheet and then close the automatic document feeder again to firmly attach the sheet.



When using the MX-2630N/MX-3050V/MX-3060V/MX-3550V/MX-3560V/MX-4050V/MX-4060V/MX-5050V/MX-6050V

1

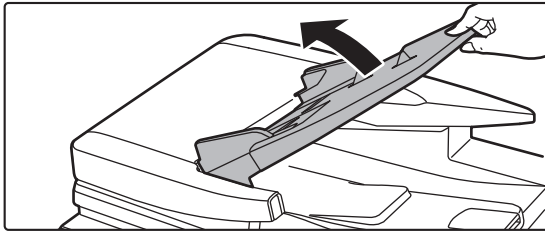

Open the document feeder tray.

2

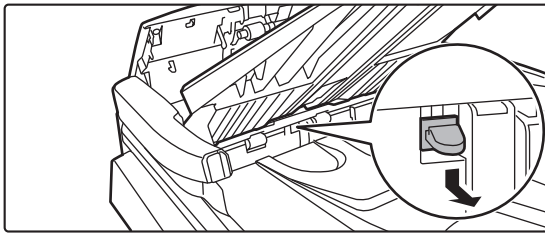

Remove the stamp cartridge while pushing it downwards.

3

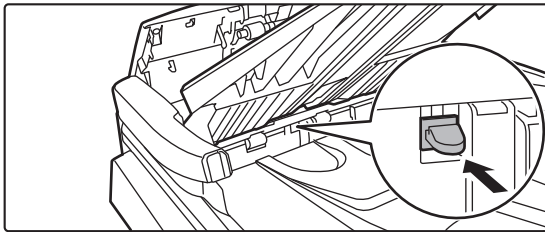

Install a new stamp cartridge.

4

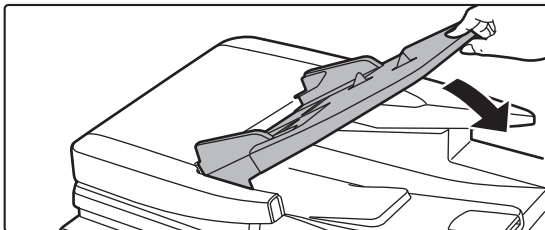

Close the document feeder tray.



CHARACTER ENTRY

NAMES AND FUNCTIONS OF SOFT KEYBOARD KEYS

Display the soft keyboard to register the name of a file, program, folder or user.

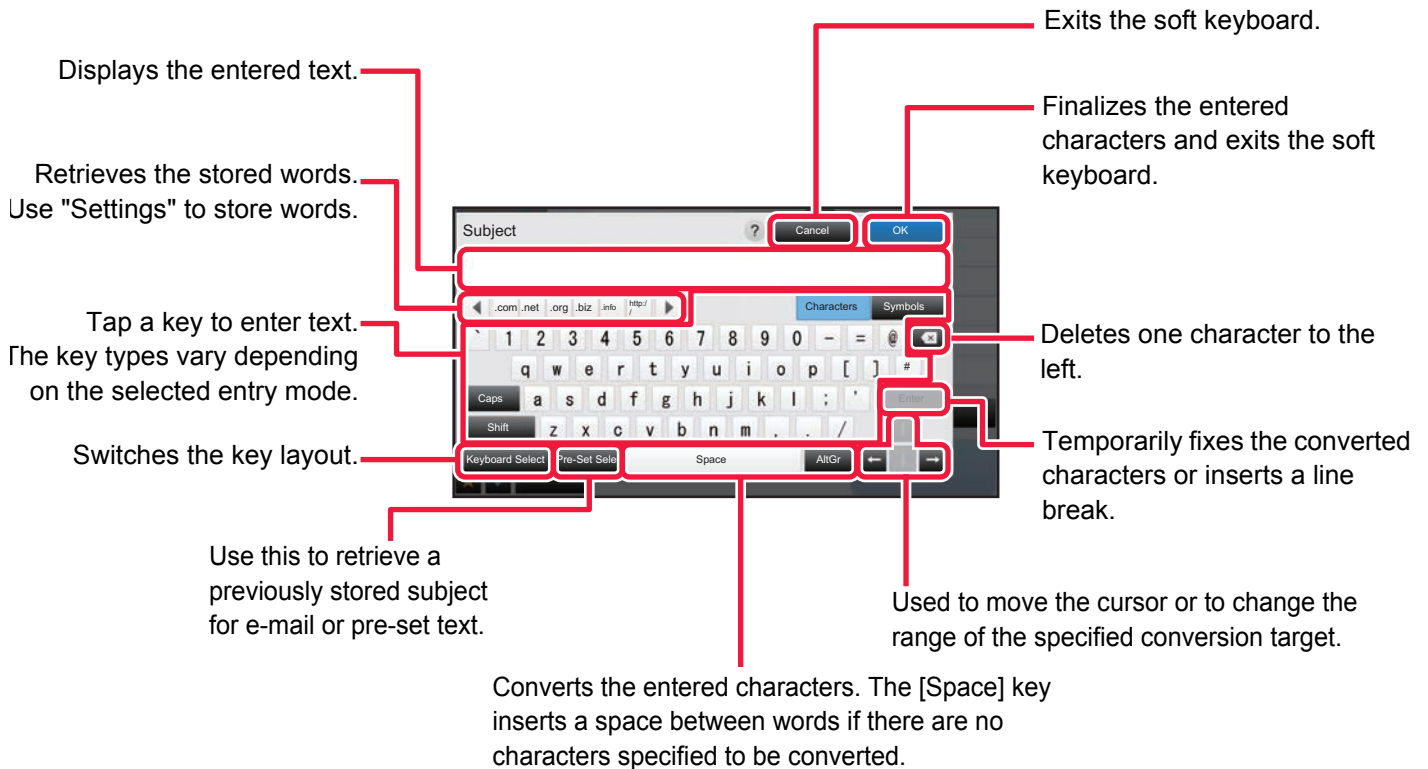

The soft keyboard shown here is an image for your reference. Different keys may be enabled depending on the actual situation and condition under which you enter characters.



If "External Keyboard" is selected in "Settings" → [System Settings] → [Common Settings] → [Keyboard Settings] → [Default Keyboard Setting] → [Set Keyboard Priority], the soft keyboard will not appear.





To register words:

In "Settings (administrator)", select [System Settings] → [Common Settings] → [Keyboard Settings] → [Soft Keyboard Template Setting].



COPIER

Icons

-  Functions you can use in Easy Copy mode
-  Eco-friendly functions
-  Functions for copying on special media

BEFORE USING THE MACHINE AS A COPIER

COPY MODE	2-3
• EASY MODE	2-3
• NORMAL MODE	2-4
SELECTING COPY MODE	2-4
COPYING SEQUENCE	2-7
COPY PREVIEW	2-9
CHECKING THE ORIGINAL SIZE	2-10
SELECTING THE PAPER TRAY FOR COPYING ...	2-13

BASIC PROCEDURE FOR MAKING COPIES

COPYING	2-14
• USING THE AUTOMATIC DOCUMENT FEEDER FOR COPYING	2-14
• USING THE DOCUMENT GLASS FOR COPYING	2-15
AUTOMATIC 2-SIDED COPYING	2-17
• USING THE AUTOMATIC DOCUMENT FEEDER FOR 2-SIDED COPYING	2-17
• USING THE DOCUMENT GLASS FOR 2-SIDED COPYING	2-18
COPY COLOUR MODES	2-20
CHANGING THE EXPOSURE AND ORIGINAL IMAGE TYPE	2-23
• AUTOMATIC ADJUSTMENT OF EXPOSURE AND ORIGINAL TYPE	2-23
• MANUAL ADJUSTMENT OF EXPOSURE AND ORIGINAL TYPE	2-23
ENLARGE/REDUCE	2-26
• AUTO RATIO SELECT	2-26
• MANUAL RATIO SELECTION	2-27
• ENLARGING/REDUCING THE LENGTH AND WIDTH SEPARATELY	2-30
SELECTING THE ORIENTATION AND SIZE OF THE ORIGINAL	2-33
STORING FREQUENTLY USED ORIGINAL SIZES ...	2-36
MAKING COPIES USING THE BYPASS TRAY ...	2-39
• MAKING COPIES USING THE BYPASS TRAY ...	2-39
• SPECIFYING A TYPE AND SIZE OF PAPER LOADED ON BYPASS TRAY	2-40

OUTPUT	2-41
• SORT/GROUP SETTING	2-41
• STAPLE SETTINGS	2-42
• PUNCH SETTINGS	2-45
• FOLD SETTING	2-47
• INSERTING SEPARATOR PAGES BETWEEN COPIES OR JOBS	2-48
BATCH COPY FUNCTIONS	2-50
• COPYING MULTIPLE ORIGINALS AS A SINGLE PAGE (N-Up)	2-50
• COPYING EACH FACING PAGE OF A BOUND DOCUMENT (DUAL PAGE COPY)	2-52
• COPYING BOTH SIDES OF A CARD AS A SINGLE PAGE (CARD SHOT)	2-54
• REPEATING THE SAME IMAGE ON ONE SHEET (REPEAT LAYOUT)	2-56

OTHER FUNCTIONS

OUTPUT AND LAYOUT EDITING FUNCTIONS ...	2-61
• MAKING COPIES IN PAMPHLET FORMAT (BOOKLET)	2-61
• COPYING MULTIPLE ORIGINALS ON EACH BOOKLET PAGE (BOOKLET 2-Up/4-Up) ...	2-64
• COPYING A PAMPHLET (BOOK COPY) ...	2-67
• SPLITTING A PAMPHLET ORIGINAL BY PAGE (BOOK DIVIDE)	2-69
PAPER, AND TIME SAVING FUNCTIONS	2-70
• SKIPPING BLANK PAGES IN AN ORIGINAL (BLANK PAGE SKIP)	2-70
• ADJUSTING THE BACKGROUND BY MAKING LIGHT AREAS OF THE ORIGINAL DARKER OR LIGHTER (BACKGROUND ADJUSTMENT)	2-72
• MAKING A PROOF COPY (PROOF COPY) ...	2-74
• CHECKING THE NUMBER OF SCANNED ORIGINAL SHEETS (ORIGINAL COUNT) ...	2-76
• USING TWO MACHINES TO REDUCE THE COPY TIME (TANDEM COPY)	2-78
• DISPLAYING ECO RECOMMENDATION SETTINGS (ECO RECOMMENDATION FUNCTION DISPLAY)	2-80





SECURITY REINFORCEMENT FUNCTIONS 2-81

- PADDING UNAUTHORIZED COPY PREVENTION DATA (HIDDEN PATTERN PRINT) 2-81
- FORCIBLY PRINTING TRACEABLE INFORMATION (TRACKING INFORMATION PRINT) 2-83

OUTPUT POSITION AND MARGIN ADJUSTMENT FUNCTIONS 2-84

- ADDING MARGINS (MARGIN SHIFT) 2-84
- ERASING PERIPHERAL SHADOWS FOR COPYING (ERASE) 2-86
- COPYING ORIGINALS WITH NO EDGE CUT-OFF (FULL BLEED COPY) 2-88
- COPYING IN THE CENTRE OF THE PAPER (CENTRING) 2-89
- SPECIFYING A PAPER POSITION (POSITION IMAGE) 2-90

SCANNING FUNCTIONS 2-92

- COLLECTIVELY SCANNING A LARGE NUMBER OF ORIGINALS (JOB BUILD) 2-92
- SCANNING ORIGINALS OF DIFFERENT SIZES (MIXED SIZE ORIGINAL) 2-95
- SCANNING THIN ORIGINALS (SLOW SCAN MODE) 2-98
- ADJUSTING RESOLUTION WHEN SCANNING (RESOLUTION) 2-99

TEXT AND IMAGE ADDITION FUNCTIONS 2-100

- PRINTING DATES, PAGE NUMBERS, AND WATERMARKS (STAMP) 2-100
- ADDING A REGISTERED IMAGE TO AN ORIGINAL (CUSTOM IMAGE) 2-103
- INSERTING COVERS IN COPIES (COVERS/INSERTS) 2-106
- INSERTING INSERTION SHEETS IN COPIES (COVERS/INSERTS) 2-114
- CHECKING, EDITING, AND DELETING THE PAGE LAYOUT OF COVERS AND INSERTION SHEETS (PAGE LAYOUT) 2-118
- INSERTING INSERTION SHEETS IN BETWEEN TRANSPARENCY FILMS (TRANSPARENCY INSERTS) 2-119

FUNCTIONS FOR SPECIFIC USES 2-121

- COPYING CAPTIONS ONTO TAB PAPER (TAB COPY) 2-121
- MAKING A POSTER-SIZED COPY (MULTI-PAGE ENLARGEMENT) 2-124
- COPYING WITH MIRROR IMAGE (MIRROR IMAGE) 2-126

OUTPUT AND DENSITY ADJUSTMENT FUNCTIONS 2-127

- REVERSING WHITE AND BLACK IN A COPY (B/W REVERSE) 2-127
- EASY ADJUSTMENT OF THE IMAGE QUALITY (QUICK IMAGE QUALITY ADJUSTMENT) 2-128

- ADJUSTING RED/GREEN/BLUE IN COPIES (RGB ADJUST) 2-129
- ADJUSTING THE SHARPNESS OF AN IMAGE (SHARPNESS) 2-130
- ADJUSTING THE COLOUR (COLOUR BALANCE) 2-131
- ADJUSTING THE BRIGHTNESS OF A COPY (BRIGHTNESS) 2-133
- ADJUSTING THE INTENSITY OF A COPY (INTENSITY) 2-134

CONVENIENT COPY FUNCTIONS

INTERRUPT COPY 2-135

SEND DATA WHILE COPYING 2-137

COPY JOBS 2-139

PROGRAMS 2-140

- STORING A PROGRAM 2-140
- RETRIEVING A PROGRAM 2-142
- DELETING AND RENAMING A PROGRAM 2-142



BEFORE USING THE MACHINE AS A COPIER

COPY MODE

There are two modes for copying: easy mode and normal mode.

Easy mode is limited to frequently used functions that allow you to smoothly perform most copy jobs.

If you need to select detailed settings or special functions, use normal mode. All functions can be used in normal mode.

EASY MODE

Easy mode makes it easy to select basic settings for copying.

1st screen

Show the size of the placed original.

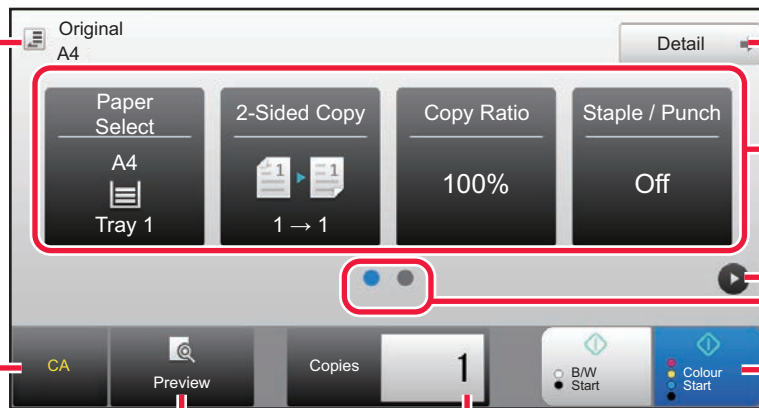

Change to normal mode.

► [NORMAL MODE](#) (page 2-4)

Select function to be set up.

Change the function display.

Starts black and white or colour copying.

Reset all settings.

Scans the original and shows a preview image.

Enter the number of copies.

► [PREVIEW SCREEN](#) (page 1-17)

2nd screen

Select function to be set up.

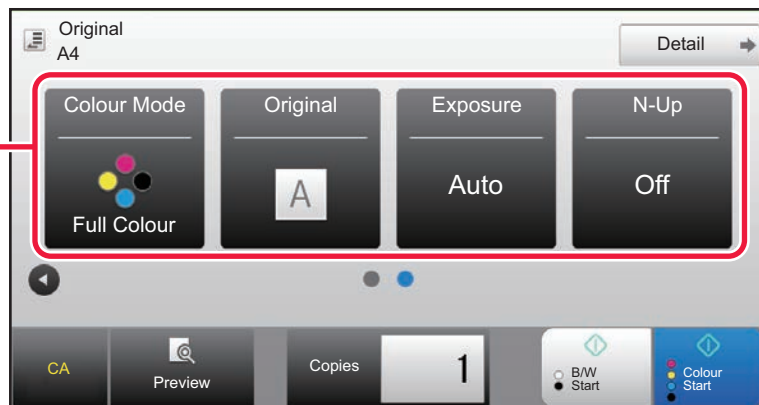

You can select these functions in easy mode.

- Paper Select ► [page 2-13](#)
- 2-Sided Copy ► [page 2-17](#)
- Copy Ratio ► [page 2-26](#)
- Staple / Punch ► [page 2-42](#), ► [page 2-45](#)
- Colour Mode ► [page 2-20](#)
- Original ► [page 2-33](#)
- Exposure ► [page 2-23](#)
- N-Up ► [page 2-50](#)
- Card Shot ► [page 2-54](#)



To select a function in easy mode

In "Settings (administrator)", select [System Settings] → [Common Settings] → [Operation Settings] → [Easy Mode Settings] → [Easy Copy]



NORMAL MODE

Normal mode lets you select any function setting that can be used for copying.

Enter the number of copies.

Setting keys used for copying.

Displays the list of function keys. Frequently used [Others], programs, and other settings can be registered.

Check the current settings.

Display keys other than the function keys indicated above.

Indicates the presence or absence of an original and the size of paper loaded in each tray. Tap to open the paper select screen.

Displays the functions that can be utilized in copy mode.

Scans the original and shows a preview image. [► PREVIEW SCREEN \(page 1-17\)](#)

Reset all settings.

Starts black and white or colour copying.



The displayed contents of the above screen will vary depending on the devices installed.

SELECTING COPY MODE

Follow the steps below to change from the Home Screen or each mode to copy mode.

Changing modes from the Home Screen

Tap a mode icon to switch from the home screen to that mode.

Shift to Easy Mode

Tap the [Easy Copy] mode icon.

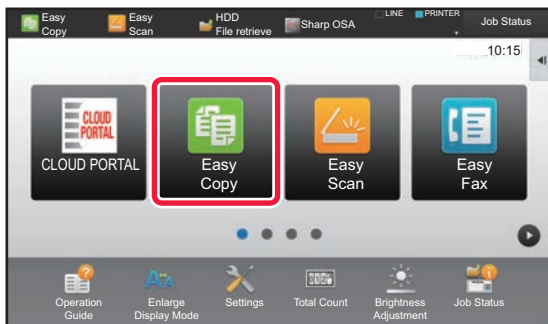

Shift to Normal Mode

Tap the [Copy] mode icon.

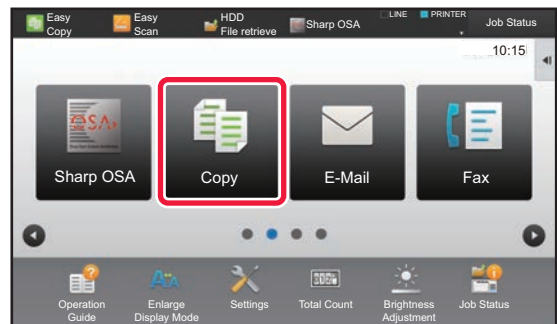



Changing mode from each mode

To switch from any of the modes, tap the mode display.

Shift to Easy Mode

1

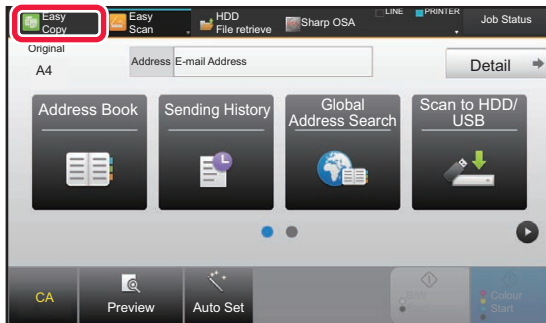

Tap [Easy Copy].

The initial screen of easy copy is displayed.



If the easy mode icon appears, tap the icon.





Shift to Normal Mode

1



Tap on the mode display.

2

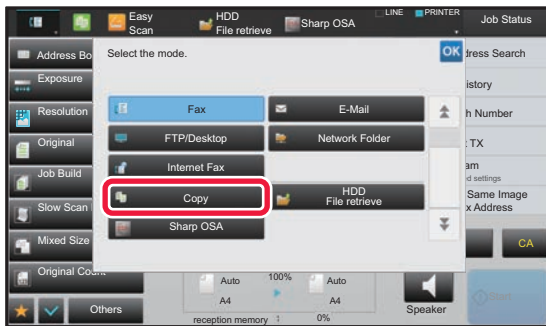

Tap the [Copy] key.

The initial copy mode screen is displayed.



To switch from the base screen of easy mode, tap the [Detail] key and then tap the [Yes] key in the confirmation screen.





COPYING SEQUENCE

This section explains the basic procedure for copying. Select settings in the order shown below to ensure that the copy operation takes place smoothly.

For detailed procedures for selecting the settings, see the explanation of each setting in this chapter.

1

Switch to copy mode.

► [SELECTING COPY MODE \(page 2-4\)](#)

2

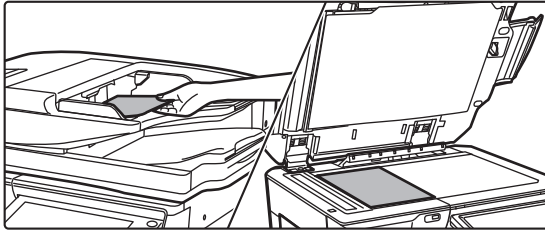

Place the original.

Place the original in the document feeder tray of the automatic document feeder, or on the document glass.

- [AUTOMATIC DOCUMENT FEEDER \(page 1-84\)](#)
- [DOCUMENT GLASS \(page 1-86\)](#)

3

Select functions.

Specify the original scan size, exposure, resolution, etc.

Tap the [Original] key and specify the orientation of the original to have the orientation be correctly recognized.

► [Specifying the orientation of the original \(page 2-33\)](#)

If necessary, you can refer to the following functions for the setting.

In Easy mode



- Paper Select ► [page 2-13](#)
- 2-Sided Copy ► [page 2-17](#)
- Copy Ratio ► [page 2-26](#)
- Staple / Punch ► [page 2-42](#), ► [page 2-45](#)
- Colour Mode ► [page 2-20](#)
- Original ► [page 2-33](#)
- Exposure ► [page 2-23](#)
- N-Up ► [page 2-50](#)
- Card Shot ► [page 2-54](#)

In Normal mode

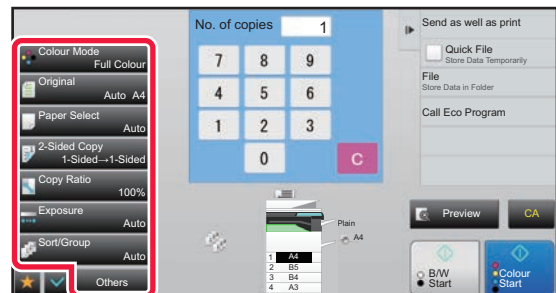

- Colour Mode ► [page 2-20](#)
- Original ► [page 2-33](#)
- Paper Select ► [page 2-13](#)
- 2-Sided Copy ► [page 2-17](#)
- Copy Ratio ► [page 2-26](#)
- Exposure ► [page 2-23](#)
- Sort/Group ► [page 2-41](#)
- Others ► [page 2-61](#)



4

Scan the original.

Tap the [Preview] key to scan the original.

In Easy mode

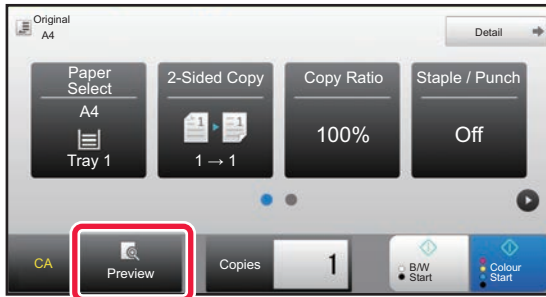

In Normal mode

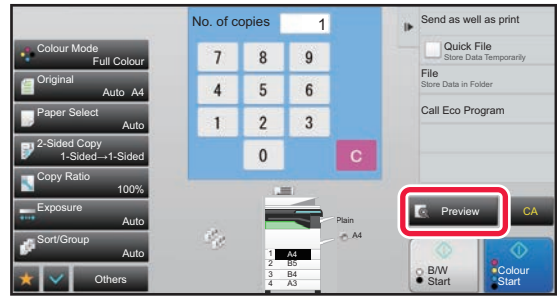

- To make 2-sided copies, configure the 2-sided copy settings before scanning the original.
 - ▶ [AUTOMATIC 2-SIDED COPYING \(page 2-17\)](#)
- When not checking the preview image, tap the [Colour Start] or [B/W Start] key to start copying.

5

Check the preview image.

Display the preview image of the scanned original.

In the preview screen, check the settings such as colour mode and 2-sided copy.

- ▶ [COPY PREVIEW \(page 2-9\)](#)

In Easy mode

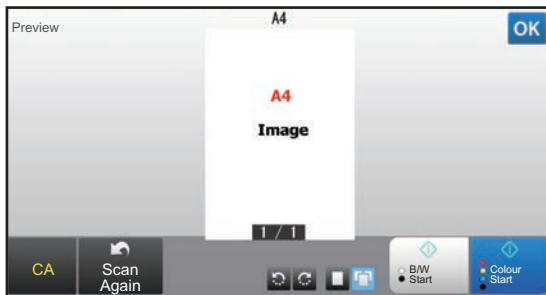

In Normal mode

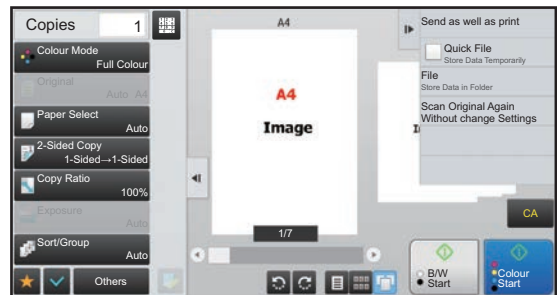



6

Tap the [Colour Start] or [B/W Start] key to start copying.

When making only one set of copies, you do not need to specify the number of copies.



- To cancel all settings, tap the [CA] key.
When the [CA] key is tapped, all settings selected to that point are cleared and you will return to the base screen.
- To cancel copying, tap the [Cancel Copy] key.



- **To make two or more sets of copies:**
Tap the copies display key to specify the number of copies.

In Easy mode

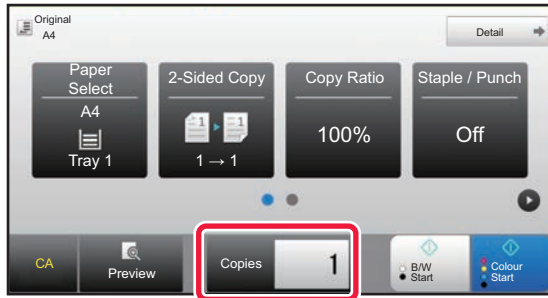

In Normal mode

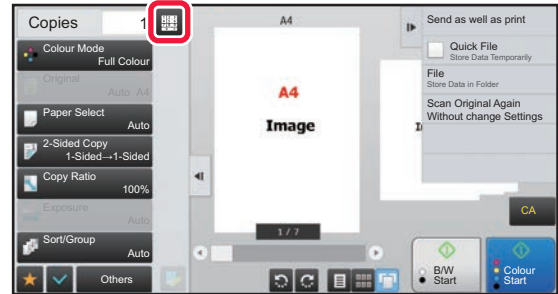

- In normal mode, you can tap [File] or [Quick File] on the action panel before starting the copy job to save the scanned original as a file.
 - ▶ [QUICK FILE \(page 6-9\)](#)
 - ▶ [FILE \(page 6-10\)](#)

COPY PREVIEW

You can tap the [Preview] key before scanning the original to check a preview of the scanned image. If you configure the preview, you can check the status of the configured preview such as the staple position or page layout.

- ▶ [PREVIEW SCREEN \(page 1-17\)](#)



In normal mode

While viewing the preview screen, you can adjust the exposure or colour, and configure the preview in your image. You can also drag the preview image to edit it, for example, changing, rotating, or deleting an original page.

- ▶ [COPY COLOUR MODES \(page 2-20\)](#)
- ▶ [MANUAL ADJUSTMENT OF EXPOSURE AND ORIGINAL TYPE \(page 2-23\)](#)

In Easy mode

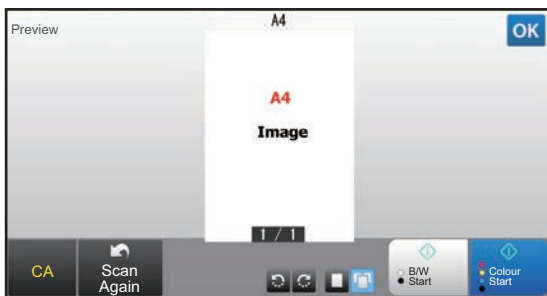

In Normal mode

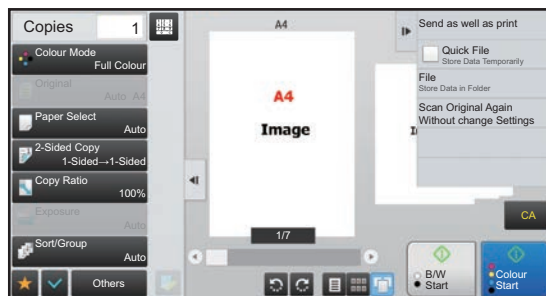



CHECKING THE ORIGINAL SIZE

Easy mode

The size of the placed original is displayed in the upper left corner of the screen.

When you place the original in the automatic document feeder, the original icon appears next to the original size.



Normal mode

Check the size of the placed original on the display of the [Original] key.

If the original size is set to [Auto], the automatically detected size (standard size) is displayed. If the original size is specified manually, the specified original size is displayed.

When you place the original in the automatic document feeder, the original icon appears above the automatic document feeder.

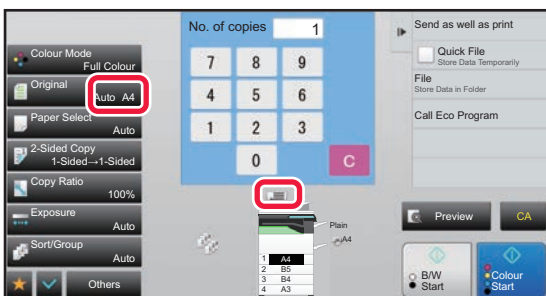



Standard sizes

Standard sizes are sizes that the machine can automatically detect.

To specify the standard size, select [System Settings] in "Settings (administrator)" → [Common Settings] → [Device Control] → [Original Size Detector Setting].

List of original size detector settings

Selections	Standard sizes (detected original sizes)	
	Document glass	Document feeder tray (automatic document feeder)
AB-1	A3, A4, A4R, A5, B4, B5, B5R	8-1/2" x 11", 8-1/2" x 14", 11" x 17", A3, A4, A4R, A5, B4, B5, B5R
AB-2	A3, A4, A4R, A5, B5, B5R, 216 mm x 330 mm (8-1/2" x 13")	8-1/2" x 11", 11" x 17", A3, A4, A4R, A5, B4, B5, B5R, 216 mm x 330 mm (8-1/2" x 13")
AB-3	A4, A4R, A5, B4, 8K, 16K, 16KR	8-1/2" x 11", 11" x 17", 216 mm x 330 mm (8-1/2" x 13"), A3, A4, A4R, A5, B4, 8K, 16K, 16KR
AB-4	216 mm x 340 mm (8-1/2" x 13-2/5"), A3, A4, A4R, A5, B5, B5R	8-1/2" x 11", 11" x 17", 216 mm x 340 mm (8-1/2" x 13-2/5"), A3, A4, A4R, A5, B4, B5, B5R
AB-5	216 mm x 343 mm (8-1/2" x 13-1/2"), A3, A4, A4R, A5, B5, B5R	8-1/2" x 11", 11" x 17", 216 mm x 343 mm (8-1/2" x 13-1/2"), A3, A4, A4R, A5, B4, B5, B5R
Inch-1	11" x 17", 8-1/2" x 14", 8-1/2" x 11", 8-1/2" x 11"R, 5-1/2" x 8-1/2"	11" x 17", 8-1/2" x 14", 8-1/2" x 11", 8-1/2" x 11"R, 5-1/2" x 8-1/2", A3, A4
Inch-2	11" x 17", 8-1/2" x 13" (216 mm x 330 mm), 8-1/2" x 11", 8-1/2" x 11"R, 5-1/2" x 8-1/2"	11"x17", 8-1/2"x13" (216 mm x 330 mm), 8-1/2"x11", 8-1/2"x11"R, 5-1/2"x8-1/2", A3, A4
Inch-3	11" x 17", 8-1/2" x 13-2/5" (216 mm x 340 mm), 8-1/2" x 11", 8-1/2" x 11"R, 5-1/2" x 8-1/2"	11"x17", 8-1/2"x13-2/5" (216 mm x 340 mm), 8-1/2"x11", 8-1/2"x11"R, 5-1/2"x8-1/2", A3, A4

* In the size notation above, when the size is suffixed by "R" like "A4R", it indicates a case where a sheet available in both the vertical and horizontal orientations are set horizontally.



- Even when [Original] is set to [Auto], some original sizes may be detected as other one that is near the standard size. In this case, manually set the original size.
 - [SELECTING THE ORIENTATION AND SIZE OF THE ORIGINAL \(page 2-33\)](#)
- When placing a non-standard size original on the document glass, you can make it easier for the size to be detected by placing a blank sheet of A4 (8-1/2" x 11"), B5 (5-1/2" x 8-1/2"), or other standard size of paper on top of the original.



Orientation of placed original

Place the original as shown below.

If you place the original in an incorrect orientation, it may result in punching at an unexpected position or stapling. On "Preview Screen", view the image orientation or preview image.

► [COPY PREVIEW \(page 2-9\)](#)

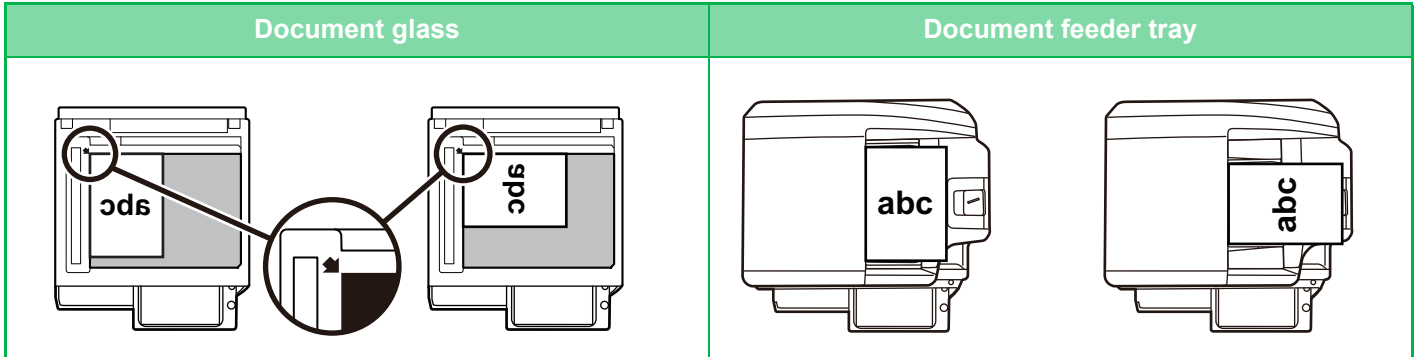

Set the orientation of the image to ensure that the orientation of the placed original is correctly recognized.

For information on the orientation of the original, see "[Specifying the orientation of the original \(page 2-33\)](#)".

Automatic copy image rotation (Rotation Copy)

If the orientation is different between the original and paper, the original image will be automatically rotated 90 degrees to match the paper.

Orientation of placed original

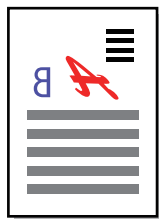

The original seen from behind

Orientation of paper

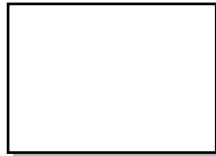

The image is rotated 90 degrees

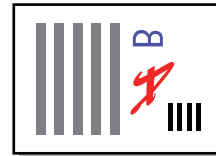

The paper seen from behind



To set Rotation Copy:

In "Settings (administrator)", select [System Settings] → [Copy Settings] → [Condition Settings] → [Rotation Copy Setting].

When [Rotation Copy] is selected, Rotation Copy operates when Auto Paper Select or Auto Ratio Select is in effect, or when the original and paper are the same size but the orientation is different.

When [Rotation Copy is done only at Auto Paper Select or Auto Ratio Select] is selected, Rotation Copy only operates when Auto Paper Select or Auto Ratio Select is in effect.



SELECTING THE PAPER TRAY FOR COPYING

The machine is set to automatically select a tray that has the same size of paper as the size of the placed original (Auto Paper Select).

If the original size cannot be detected correctly because it is a non-standard size or when you want to change the paper size for copying, you can select the paper tray manually.



If the selected tray runs out of paper during a copy job and there is another tray that has the same size and type of paper, that tray will be automatically selected and the copy job will continue.



To change the initially selected tray:

In "Settings (administrator)", select [System Settings] → [Copy Settings] → [Initial Status Settings] → [Paper Tray].

1

Tap the [Paper Select] key.

► [COPYING SEQUENCE \(page 2-7\)](#)

2

Tap the required tray key.

After the settings are completed, tap **OK**.

In Easy mode

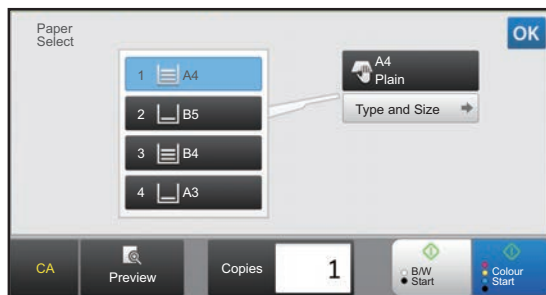

In Normal mode

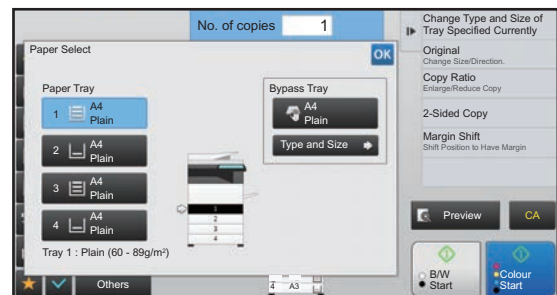

- When the bypass tray is selected, specify the paper type and size based on the paper loaded into the bypass tray.
 - [SPECIFYING A TYPE AND SIZE OF PAPER LOADED ON BYPASS TRAY \(page 2-40\)](#)
- In normal mode, you can also open the [Paper Select] screen by tapping the machine image on the base screen.



To automatically select the tray, tap the [CA] key. When the [CA] key is tapped, all settings selected to that point are cleared and you will return to the base screen.



BASIC PROCEDURE FOR MAKING COPIES

This section explains how to select settings from the base screen of easy mode.

► [SELECTING COPY MODE \(page 2-4\)](#)

COPYING

USING THE AUTOMATIC DOCUMENT FEEDER FOR COPYING

1

Place the original in the document feeder tray of the automatic document feeder.

► [AUTOMATIC DOCUMENT FEEDER \(page 1-84\)](#)

2

Check the paper (tray) and colour mode you want to use for copying, and tap the keys for any other settings you want to select.

- Paper Select ► [page 2-13](#)
- 2-Sided Copy ► [page 2-17](#)
- Copy Ratio ► [page 2-26](#)
- Staple / Punch ► [page 2-42](#), ► [page 2-45](#)
- Colour Mode ► [page 2-20](#)
- Original ► [page 2-33](#)
- Exposure ► [page 2-23](#)
- N-Up ► [page 2-50](#)
- Card Shot ► [page 2-54](#)



Depending on the size of the placed original, there may be cases where the same size of paper as the original is not selected automatically. In this event, change the paper tray manually.

3

Tap the [Preview] key.

► [PREVIEW SCREEN \(page 1-17\)](#)



4

Tap the [Colour Start] or [B/W Start] key to start copying.

When making only one set of copies, you do not need to specify the number of copies.



To make two or more sets of copies:

Tap the number of copies key to specify the number of copies.

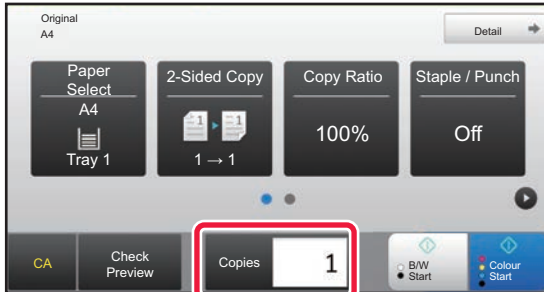

USING THE DOCUMENT GLASS FOR COPYING

1

Place the original on the document glass.

► [DOCUMENT GLASS \(page 1-86\)](#)

2

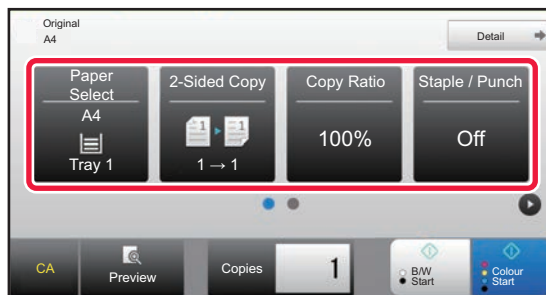

Check the paper (tray) and colour mode you want to use for copying, and tap the keys for any other settings you want to select.

- Paper Select ► [page 2-13](#)
- 2-Sided Copy ► [page 2-17](#)
- Copy Ratio ► [page 2-26](#)
- Staple / Punch ► [page 2-42](#), ► [page 2-45](#)
- Colour Mode ► [page 2-20](#)
- Original ► [page 2-33](#)
- Exposure ► [page 2-23](#)
- N-Up ► [page 2-50](#)
- Card Shot ► [page 2-54](#)

3

Tap the [Preview] key.

► [PREVIEW SCREEN \(page 1-17\)](#)



4

Tap the [Colour Start] or [B/W Start] key to start copying.

When making only one set of copies, you do not need to specify the number of copies.



To make two or more sets of copies:

Tap the number of copies key to specify the number of copies.

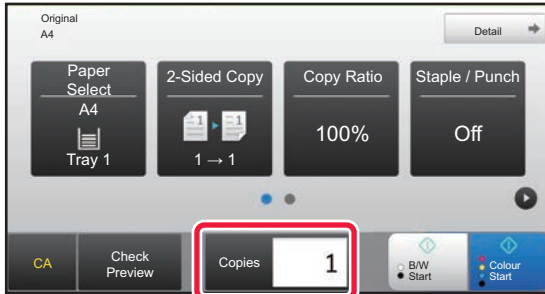



AUTOMATIC 2-SIDED COPYING

USING THE AUTOMATIC DOCUMENT FEEDER FOR 2-SIDED COPYING

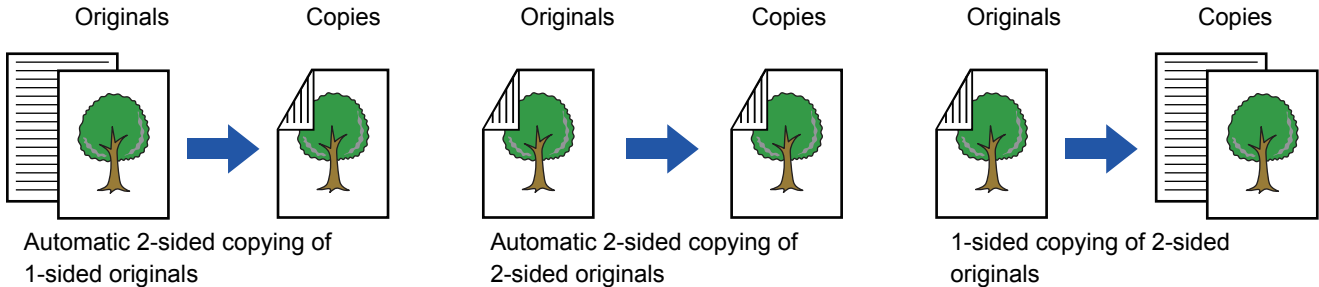

- To make 2-sided copies, configure the 2-sided copy settings before scanning the original.
- Dual-side copy helps to save paper.

1

Place the original in the document feeder tray of the automatic document feeder.

▶ [AUTOMATIC DOCUMENT FEEDER \(page 1-84\)](#)

2

Tap the [2-Sided Copy] key.

▶ [COPYING SEQUENCE \(page 2-7\)](#)

3

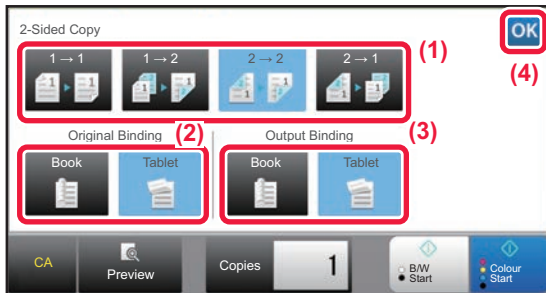

Select 2-sided copy mode.

- (1) Select the 2-sided copy type.
- (2) When the original is set to "2-Sided", select "Tablet" or "Book" in "Original Binding".
- (3) When the output is set to "2-Sided", select "Tablet" or "Book" in "Output Binding".
- (4) After the settings are completed, tap **OK**.

4

Check the paper (tray) and colour mode you want to use for copying, and tap the keys for any other settings you want to select.

Tap the [Original] key and specify the orientation of the original to have the orientation be correctly recognized.

▶ [Specifying the orientation of the original \(page 2-33\)](#)

- Paper Select ▶ [page 2-13](#)
- Copy Ratio ▶ [page 2-26](#)
- Staple / Punch ▶ [page 2-42](#), ▶ [page 2-45](#)
- Colour Mode ▶ [page 2-20](#)
- Original ▶ [page 2-33](#)
- Exposure ▶ [page 2-23](#)
- N-Up ▶ [page 2-50](#)
- Card Shot ▶ [page 2-54](#)



5

Tap the [Preview] key.

6

Tap the [Colour Start] or [B/W Start] key to start copying.

USING THE DOCUMENT GLASS FOR 2-SIDED COPYING

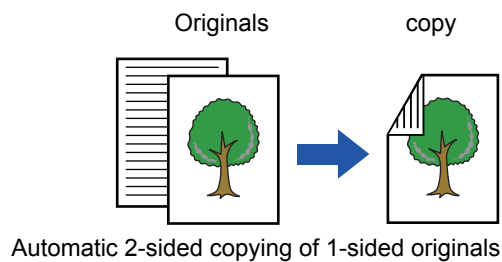

Dual-side copy helps to save paper.



To change the default 2-sided copy mode:

In "Settings (administrator)", select [System Settings] → [Copy Settings] → [Initial Status Settings] → [2-Sided Copy].

1

Place the original on the document glass.

▶ [DOCUMENT GLASS \(page 1-86\)](#)

2

Tap the [2-Sided Copy] key.

▶ [COPYING SEQUENCE \(page 2-7\)](#)

3

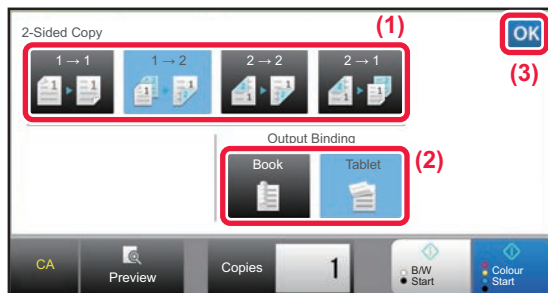

Select the 2-sided copy mode.

(1) Tap the [1 → 2] key.

(2) When the output is set to "2-Sided", select "Tablet" or "Book" in "Output Binding".

(3) After the settings are completed, tap **OK**.



The [2 → 2] key and [1 → 2] key cannot be used when copying from the document glass.



4



Check the paper (tray) and colour mode you want to use for copying, and tap the keys for any other settings you want to select.

Tap the [Original] key and specify the orientation of the original to have the orientation be correctly recognized.

► [Specifying the orientation of the original \(page 2-33\)](#)

- Paper Select ► [page 2-13](#)
- Copy Ratio ► [page 2-26](#)
- Staple / Punch ► [page 2-42](#), ► [page 2-45](#)
- Colour Mode ► [page 2-20](#)
- Original ► [page 2-33](#)
- Exposure ► [page 2-23](#)
- N-Up ► [page 2-50](#)
- Card Shot ► [page 2-54](#)



Depending on the size of the placed original, there may be cases where the same size of paper as the original is not selected automatically. In this event, change the paper tray manually.

5

Tap the [Preview] key.

6

Tap the [Colour Start] or [B/W Start] key.

7

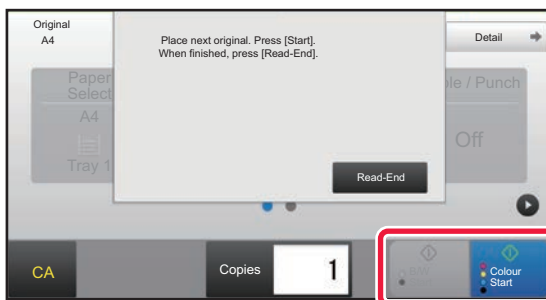

Set the next original, and tap the [Colour Start] or [B/W Start] key to scan the original.

Tap the same key you tapped in step 6.

Repeat this step until all originals have been scanned.

8

Tap the [Read-End] key to start copying.



COPY COLOUR MODES

Select the colour mode from Auto, Full Colour, B/W, 2 Colour, and Single Colour.

Auto	The machine automatically detects whether each original is colour or black & white and switches the mode appropriately (full colour for a colour original or black & white for a black & white original).
Full Colour	The original is copied in full colour.
B/W	The original is copied in black and white.
2 Colour	The original is copied in two colours by changing a specific colour used in the original to another colour. If red is set to a specific colour, reddish parts in an original are extracted, and changed to the specified colour to make a copy.
Single Colour*	The original is copied in any one colour regardless of the colours used in the original.

* Can be set in normal mode.



If any colour mode is selected, copying takes place in black and white when you tap the [B/W Start] key.



- **To change the default colour mode:**

In "Settings (administrator)", select [System Settings] → [Copy Settings] → [Initial Status Settings] → [Colour Mode].

- **To change the standard to detect Black & White and Colour:**

In "Settings (administrator)", select [System Settings] → [Common Settings] → [Device Control] → [Detect Standard in Auto Colour Mode].

When the colour mode is set to auto in copy mode, the discrimination point for detecting whether originals are colour or black and white can be set to one of 5 levels. When set to [Closer to B/W], the originals are easier to recognize as black and white. When set to [Closer colour], the originals are easier to recognize as colour.

1



Tap the [Colour Mode] key.

2

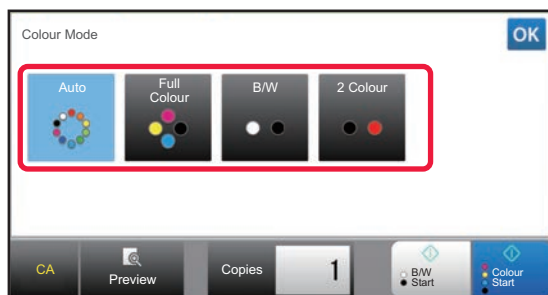

Select the colour mode.

After the settings are completed, tap **OK**.
Check that the specified colour mode is selected.



- When auto mode is used, there may be some originals for which switching between colour and black & white does not take place correctly. If so, tap the [Colour Start] or [B/W Start] key to manually switch between colour and black & white.
- When [B/W Start] is selected, the [Colour Start] key cannot be tapped.



Copying in two colours

The original is copied in two colours by changing a specific colour to another colour.

1

Tap the [Colour Mode] key.

2

Tap the [2 Colour] key.

3

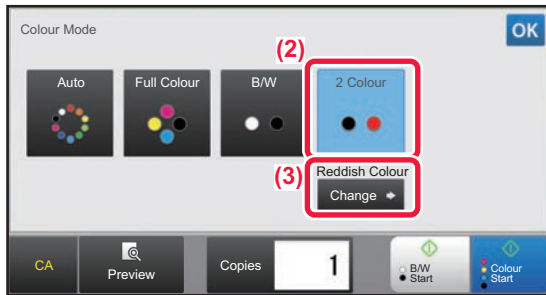

Tap the [Change] key.

4

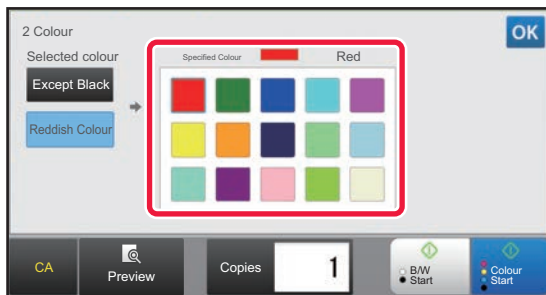

Tap the key of the colour to be extracted to specify the extract colour.

- **[Except Black]:**
Extracts black parts in an original, and changes non-black parts to the specified colour.
- **[Reddish Colour]:**
Extracts reddish parts in an original, and changes them to the specified colour.

5

Specify the colour to change the extracted colour to.

After the settings are completed, tap the **OK** key on the [2 Colour] screen, and check that the changed setting is displayed at the side of [2 Colour] key on the colour mode screen.

After you have checked it, tap **OK**.

Check that the specified colour mode is selected.



Copying in single colour

The original is copied in any one colour.

1

Tap the [Detail] key to change to normal mode.

► [Changing mode from each mode \(page 2-5\)](#)

2

Tap the [Colour Mode] key.

3

Tap the [Single Colour] key.

4

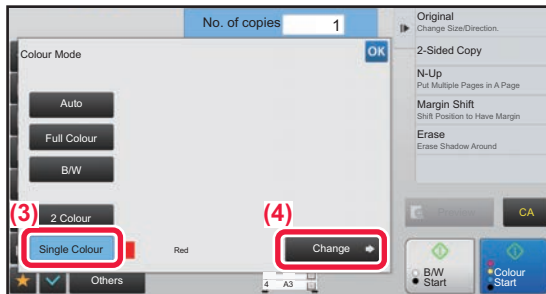

Tap the [Change] key.

5

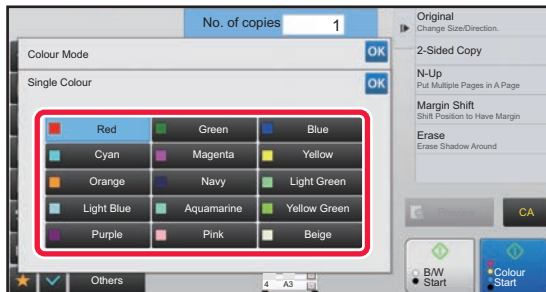

Tap a colour you wish to use.

After the settings are completed, tap **OK** on the [Single Colour] screen, and check that the changed setting is displayed at the side of [Single Colour] key on the colour mode screen.

After you have checked it, tap **OK** on the [Colour Mode] screen.



CHANGING THE EXPOSURE AND ORIGINAL IMAGE TYPE

AUTOMATIC ADJUSTMENT OF EXPOSURE AND ORIGINAL TYPE

Automatic exposure adjustment operates by default to automatically adjust the exposure level and original type as appropriate for the original being copied. ([Auto] is displayed.)

This function automatically adjusts the image during black & white copying and full colour copying to obtain the most suitable copy.

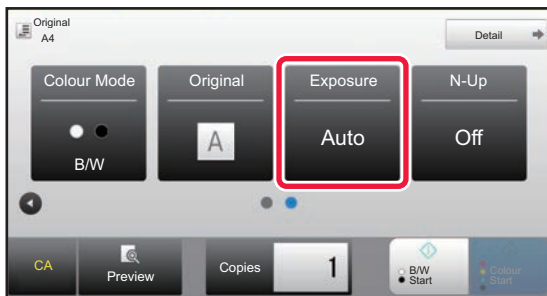

- **To change the default exposure:**

In "Settings (administrator)", select [System Settings] → [Copy Settings] → [Initial Status Settings] → [Exposure Type].

- **To adjust the exposure level when [Auto] is used for the copy exposure:**

In "Settings (administrator)", select [System Settings] → [Image Quality Adjustment] → [Copy Image Quality] → [Density Adjustment when [Auto] is selected for Exposure].

MANUAL ADJUSTMENT OF EXPOSURE AND ORIGINAL TYPE

This section explains how to select the original type depending on the original to be copied or manually adjust the exposure.



- **To change the default exposure:**

In "Settings (administrator)", select [System Settings] → [Copy Settings] → [Initial Status Settings] → [Exposure Type].

1

Tap the [Exposure] key.

► [COPY MODE \(page 2-3\)](#)



2

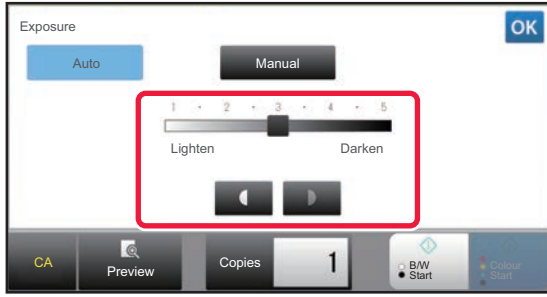

Tap or slide the slider to adjust the copy exposure.

After the adjustment, tap .
This completes the procedure in easy mode.

3

To select more detailed settings, tap the [Detail] key to switch to normal mode.

► [Changing mode from each mode \(page 2-5\)](#)

4

Tap the [Exposure] key.

5

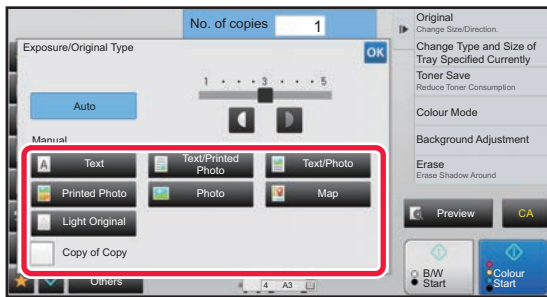

Tap the required original image type key to specify the original type.

Tap the key matching the original.

Original image type select keys

- Text Use this mode for regular text documents.
- Text/Printed Photo This mode provides the best balance for copying an original which contains both text and printed photographs, such as a magazine or catalogue.
- Text/Photo This mode provides the best balance for copying an original which contains both text and photographs, such as a text document with a photo pasted on.
- Printed Photo This mode is best for copying printed photographs, such as photos in a magazine or catalogue.
- Photo Use this mode to copy photos.
- Map This mode is best for copying the light colour shading and fine text found on most maps.
- Light Original Use this mode for originals with light pencil writing.



- When using a copy or printed page from the machine as an original:
When using a copy or printed page from the machine as an original, tap the [Copy of Copy] checkbox so that appears.
[Copy of Copy] is available when [Auto], [Text], [Printed Photo], or [Text/Printed Photo] is selected as the original image type.
- To enhance the colour of a colour copy:
Tap the [Colour Tone Enhancement] checkbox so that appears.
Set the [Colour Tone Enhancement] when you select an original type.





- [Copy of Copy] and [Colour Tone Enhancement] cannot be specified together.
- [Copy of Copy] and [Colour Tone Enhancement] cannot be combined with [Intensity] in "Others".

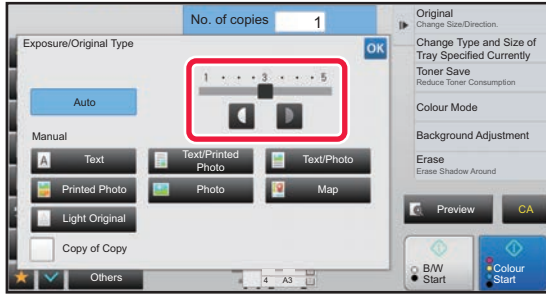

6



Tap   or slide the slider to adjust the copy exposure.

If you adjust the exposure with the original type selected to [Auto], the original image type is automatically selected to [Text/Printed Photo].

After the adjustment, tap .



Guidelines for the exposure level when [Text] is selected for "Exposure/Original Type"

- 1 to 2: Dark originals such as a newspaper
- 3: Normal density originals
- 4 to 5: Originals written in pencil or light coloured text



ENLARGE/REDUCE

AUTO RATIO SELECT

This section explains how to automatically select the appropriate ratio to meet the paper size when manually changing the paper tray to make a copy on paper that has a size different from the original.



For a non-standard size original, the size must be entered in order to use Auto Image.



To change the default ratio:

In "Settings (administrator)", select [System Settings] → [Copy Settings] → [Initial Status Settings] → [Copy Ratio].

1

Manually select the paper tray, and place the original.

Place the original in the document feeder tray of the automatic document feeder, or on the document glass.

- ▶ [SELECTING THE PAPER TRAY FOR COPYING \(page 2-13\)](#)
- ▶ [AUTOMATIC DOCUMENT FEEDER \(page 1-84\)](#)
- ▶ [DOCUMENT GLASS \(page 1-86\)](#)

2

Tap the [Copy Ratio] key.

- ▶ [COPY MODE \(page 2-3\)](#)

3

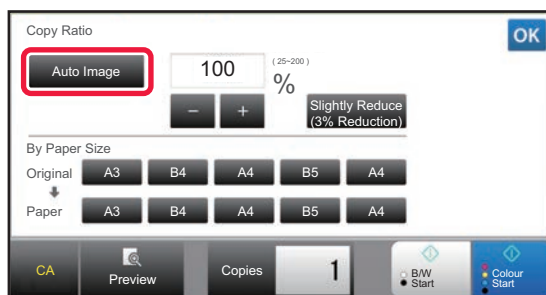

Tap the [Auto Image] key.

The reduction or enlargement ratio is automatically selected based on the original size and the selected paper size. The automatically selected ratio will appear in the ratio display.



- **To cancel the Auto Ratio Selection setting:**
Tap [Auto Image] to deselect it.
- **To return the ratio to 100%:**
Tap the [100%] key.



MANUAL RATIO SELECTION

This section explains how to specify any ratio when making a copy on paper that has a size different from the original or changing the image size for copying.

The following three methods can be used to specify the ratio.

Using the preset ratio key

Specify any ratio by combination of preset ratio key, for which the enlargement and reduction ratio values are pre-registered between the frequently used standard sizes, with the zoom key, which allows you to adjust the ratio in 1% units like **-** **+**.

Up to two ratio values can be added to preset ratio keys, respectively for enlargement and reduction.

Specifying the paper size

Specify the paper sizes of the original and output to automatically obtain the appropriate ratio.

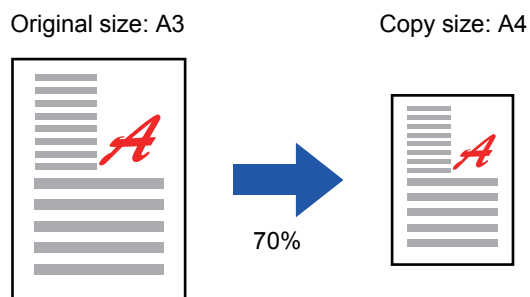

Specifying the image dimensions

Specify the image sizes of the original and output to automatically obtain the appropriate ratio.

To make a copy with the same ratio between the vertical and horizontal sizes, enter either one of the vertical and horizontal sizes.

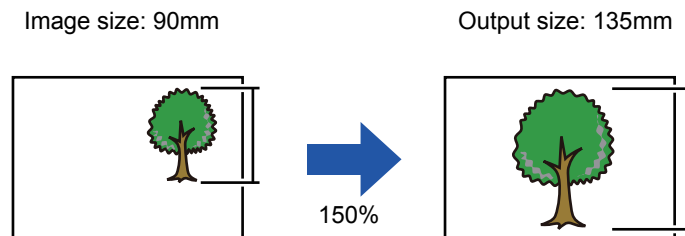

When the automatic document feeder is used, the vertical and horizontal ratio selection ranges are both between 25% to 200%.



To return the ratio to 100%:

Tap the [100%] key.



To add any ratio as a preset ratio:

In "Settings (administrator)", select [System Settings] → [Copy Settings] → [Condition Settings] → [Add or Change Extra Preset Ratios]. To select the added preset ratio, tap the [Other Ratio] key.



Using the preset ratio key

1

Tap the [Copy Ratio] key.

▶ [COPY MODE \(page 2-3\)](#)

2



Tap **-** **+** to set the ratio.

After the settings are completed, tap **OK**.

Check that a paper size suitable for the ratio is selected.



- If you tap the [Slightly Reduce (3% Reduction)] key, the ratio will be set lower than the specified one by 3%.

In normal mode

- There are two setting screens. Use the [Other Ratio] key to switch between the screens.
- To quickly set the area, first specify a value close to the desired value by the numeric keys, then adjust it with **-** **+**.
- Up to two frequently used ratio values can be added to the preset ratio key, respectively for enlargement and reduction.

▶ [Copy Settings \(page 7-82\)](#)



To cancel all settings:

Tap the [CA] key.

Specifying the paper size

1

Tap the [Copy Ratio] key.

▶ [COPY MODE \(page 2-3\)](#)

2

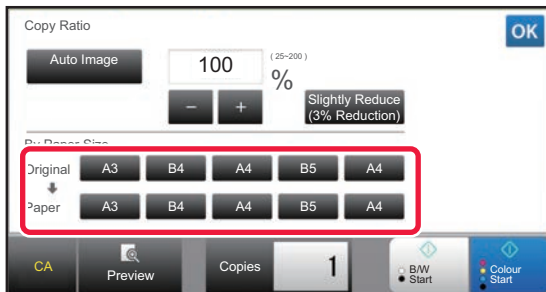

Specify the original size (paper size of the loaded original) and the copy size (paper size of the copy output).

After the settings are completed, tap **OK**.



To cancel all settings:

Tap the [CA] key.



Specifying the image dimensions

1

Tap the [Detail] key to change to normal mode.

▶ [Changing mode from each mode \(page 2-5\)](#)

2

Tap the [Copy Ratio] key.

3

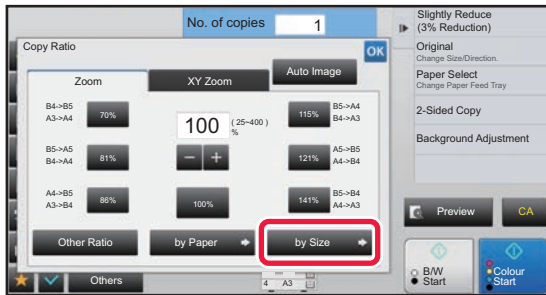

Tap the [by Size] key of the [Zoom] tab.

4

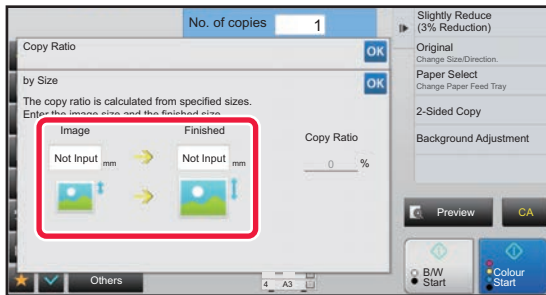

Specify the image size (dimensions of the image to be enlarged or reduced) and the output size (dimensions of the enlarged and reduced images).

Tap the area of image size and output size, and enter the sizes using the numeric keys.

After the settings are completed, tap **OK**.



- **If you have entered an incorrect size:**
Tap the [C] key, and then enter the correct size.
- **To cancel all settings:**
Tap the [CA] key.



ENLARGING/REDUCING THE LENGTH AND WIDTH SEPARATELY

This section explains how to individually specify the horizontal and vertical copy ratios.

When 50% is selected for the horizontal ratio and 70% is selected for the vertical ratio

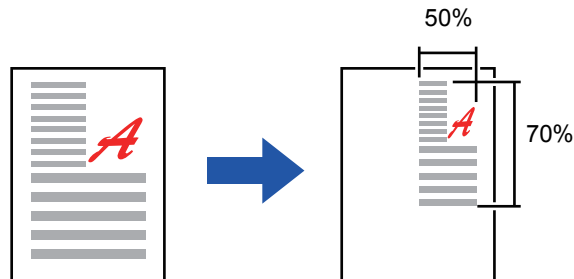

The following two methods can be used to specify the ratio.

Using the preset ratio key

Specify any ratio by combination of preset ratio key, which is pre-registered, with the **- +** key, which allows you to adjust the ratio in 1% units.

Specifying the image dimensions

Specify the image sizes of the original and output to automatically obtain the appropriate ratio.
Enter the vertical and horizontal sizes.



When the automatic document feeder is used, the vertical and horizontal ratio selection ranges are both between 25% to 200%.



To cancel the XY zoom setting:
Tap the [Zoom] tab or the [CA] key.

Using the preset ratio key

1

Tap the [Detail] key to change to normal mode.

► [Changing mode from each mode \(page 2-5\)](#)

2

Tap the [Copy Ratio] key, and then tap the [XY Zoom] tab.



3

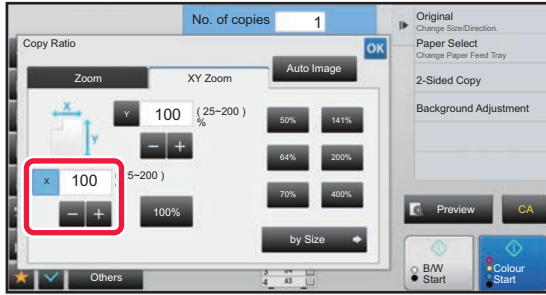

Tap the [X] key, and set the X (horizontal) ratio.



- To quickly set the ratio, first specify a value close to the desired one, then adjust it with **-** **+**.
- Tap each area of the X (horizontal) and Y (vertical) directions, and enter the sizes using the numeric keys.

4

Tap the [Y] key, and set the Y (vertical) ratio in the same way as the [X] key.

After the settings are completed, tap **OK**.
Check that a paper size suitable for the ratio is selected.

Specifying the image dimensions

1

Tap the [Detail] key to change to normal mode.

► [Changing mode from each mode \(page 2-5\)](#)

2

Tap the [Copy Ratio] key, and then tap the [XY Zoom] tab.

3

Tap the [by Size] key.



4

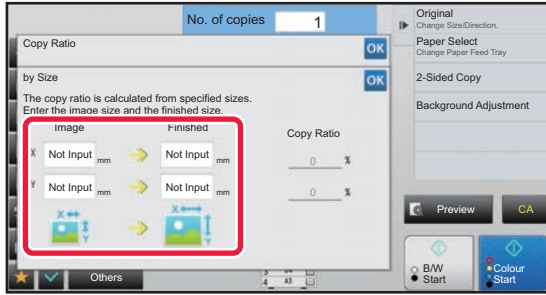

Specify the X and Y dimensions of the image size and those of the output size.

Check that a paper size suitable for the ratio is selected. After the settings are completed, tap **OK**.



Tap the image size and output size areas, and enter the sizes using the numeric keys.



- **If you have entered an incorrect size:**
Tap the [C] key on the numeric keys that appears when you tap the entry area, and set to the correct size.
- **To cancel all settings:**
Tap the [CA] key.



SELECTING THE ORIENTATION AND SIZE OF THE ORIGINAL

When the original size is a non-standard size or is not detected correctly, manually specify the original size. Set the orientation of the image to ensure that the orientation of the placed original is correctly recognized.



- Set the orientation and size of the original before scanning the original.
- The original size is set in normal mode.

Specifying the orientation of the original

By specifying the starting side (top or left side) of the placed original, the orientation of the original will be correctly recognized.

Finishing position settings and N-Up layout settings are specified using the recognized orientation.

In Easy mode



In Normal mode

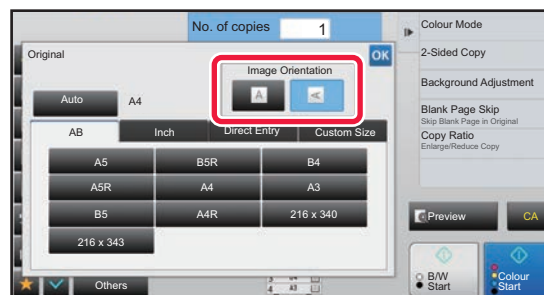

Specifying the orientation and size of an AB-size original

1

Tap the [Original] key to set the orientation of the original.

► [COPY MODE \(page 2-3\)](#)

2

Tap the [Detail] key to change to normal mode.

► [Changing mode from each mode \(page 2-5\)](#)

3

Tap the [Original] key.

4

Tap the [AB] tab.



5

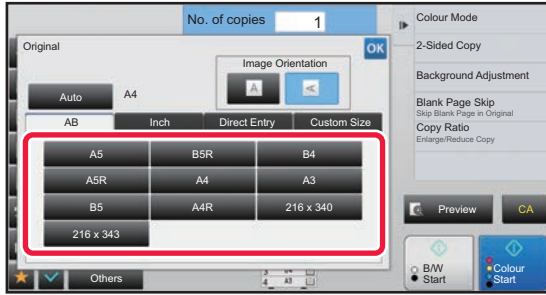

Tap the appropriate original size key.

After the settings are completed, tap **OK**.

Specifying the orientation and size of an inch-size original

1

Tap the [Original] key to set the orientation of the original.

► [COPY MODE \(page 2-3\)](#)

2

Tap the [Detail] key to change to normal mode.

► [Changing mode from each mode \(page 2-5\)](#)

3

Tap the [Original] key.

4

Tap the [Inch] tab.

5

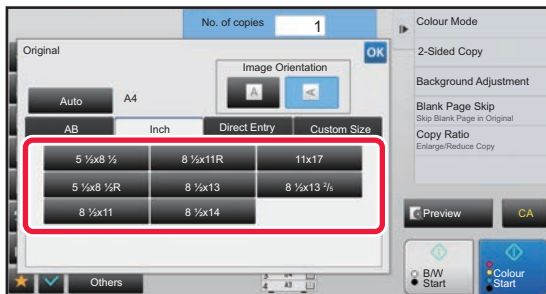

Tap the appropriate original size key.

After the settings are completed, tap **OK**.



Specifying the orientation and size of a non-standard size originals

1

Tap the [Original] key to set the orientation of the original.

► [COPY MODE \(page 2-3\)](#)

2

Tap the [Detail] key to change to normal mode.

► [Changing mode from each mode \(page 2-5\)](#)

3

Tap the [Original] key.

4

Tap the [Direct Entry] tab.

5

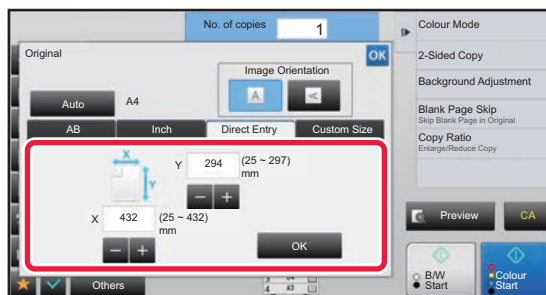

Specify the original size.



- Tap the areas displaying width and height sizes respectively, and enter the sizes using the numeric keys.
- It is convenient to use **- +** to finely adjust the entered size.

6

Tap the [OK] key.

On the base screen, check that the specified size is displayed on the [Original] key.
After the settings are completed, tap **OK**.



STORING FREQUENTLY USED ORIGINAL SIZES

Store the frequently used non-standard original sizes. This section explains how to store, retrieve, change, and delete non-standard original sizes.



- The stored original size will be retained even if the main power is turned off.
- A total of up to 12 non-standard original sizes can be registered for copying, fax, and image sending.
- The added original sizes will also appear in other modes.

Storing original sizes (Amend/Delete)

1

Tap the [Detail] key to change to normal mode.

► [Changing mode from each mode \(page 2-5\)](#)

2

Tap the [Original] key.

3

Tap the [Custom Size] tab.

4

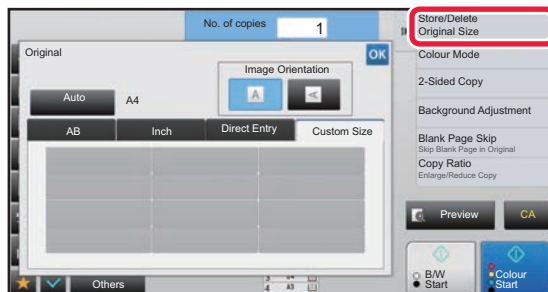

Tap [Store/Delete Original Size] on the action panel.



5

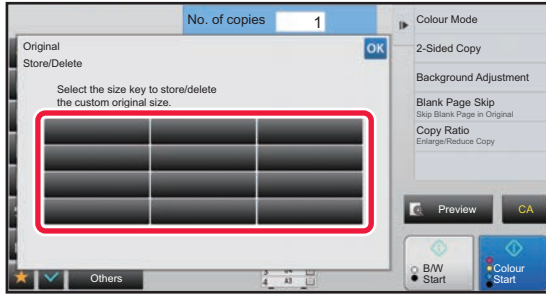

Tap a key () for storing a custom original size.

Tap a key that does not show a size.



To amend or delete a previously stored key:

Tap the key that you want to amend or delete. The following screen will appear.

- To amend the key, tap the [Amend] key and go to the next step.
- To delete the key, tap the [Delete] key. Make sure that the original size has been cleared and tap the [OK] key.

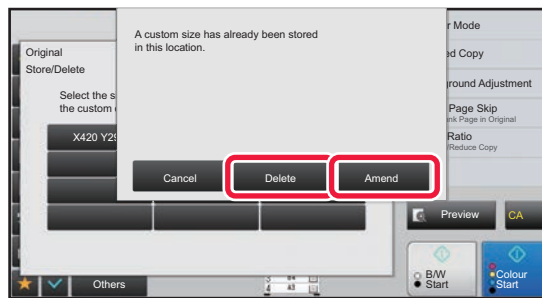

6

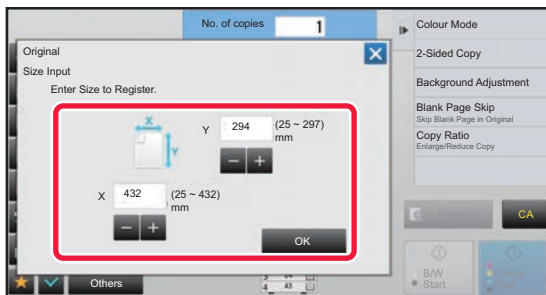

Specify the original size.

Tap the areas displaying width and height sizes respectively, and enter the sizes using the numeric keys.



It is convenient to use - + to finely adjust the entered size.

7

Tap the [OK] key

After the settings are completed, tap the [X] key, and check that the key of the size stored on the original screen is added properly. After you have checked it, tap [OK].



To cancel the operation:

Tap the [CA] key.



Retrieving a stored original size

1

Tap the [Detail] key to change to normal mode.

► [Changing mode from each mode \(page 2-5\)](#)

2

Tap the [Original] key.

3

Tap the [Custom Size] tab.

4

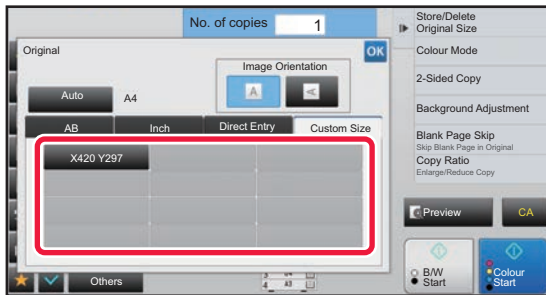

Tap the key of the original size that you wish to retrieve.

After selecting the key of the original size, tap the **OK** key. On the base screen, check that the specified size is displayed on the [Original] key.



To cancel the operation

Tap the [CA] key.



MAKING COPIES USING THE BYPASS TRAY

MAKING COPIES USING THE BYPASS TRAY

In addition to plain paper, the bypass tray allows you to make copies on transparency film, envelopes, tab paper, and other special media.



For detailed information on paper that can be loaded into the bypass tray, see "[APPLICABLE PAPER TYPES \(page 1-68\)](#)".
For precautions on loading paper into the bypass tray, see "[LOADING PAPER INTO THE BYPASS TRAY \(page 1-78\)](#)".

1

Load paper into the bypass tray.

► [LOADING PAPER INTO THE BYPASS TRAY \(page 1-78\)](#)

2

Tap the [Paper Select] key, and tap the bypass tray key.

Each tray key displays the size and type of the loaded paper.

► [SELECTING THE PAPER TRAY FOR COPYING \(page 2-13\)](#)

3

To select more detailed settings, tap the [Detail] key to switch to normal mode.

► [Changing mode from each mode \(page 2-5\)](#)

4

Tap the [Paper Select] key.

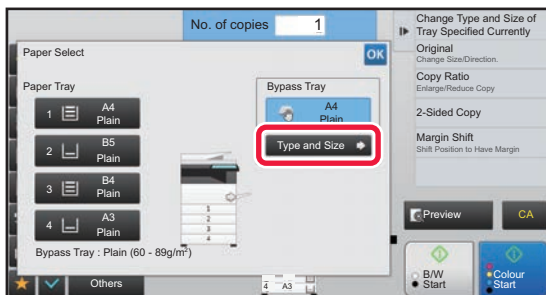
5

Tap the [Type and Size] key, and select the size and type of the paper.

► [SPECIFYING A TYPE AND SIZE OF PAPER LOADED ON BYPASS TRAY \(page 2-40\)](#)

6

Place the original.

Place the original in the document feeder tray of the automatic document feeder, or on the document glass.

► [AUTOMATIC DOCUMENT FEEDER \(page 1-84\)](#)

► [DOCUMENT GLASS \(page 1-86\)](#)

7

Tap the [Colour Start] or [B/W Start] key to start copying.



SPECIFYING A TYPE AND SIZE OF PAPER LOADED ON BYPASS TRAY

1

Tap the [Paper Select] key, and tap the bypass tray key.

▶ [SELECTING THE PAPER TRAY FOR COPYING \(page 2-13\)](#)

2

Tap the [Type and Size] key, and tap the key that meets the type of the loaded paper.

3

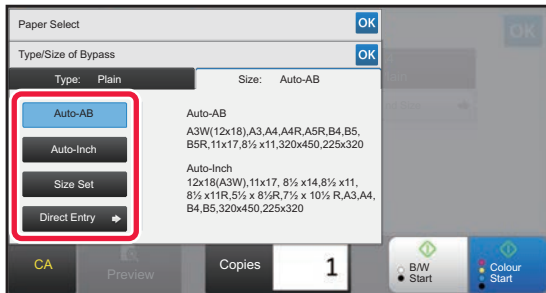

Tap the [Size] tab, and tap the key that meets the size of the loaded paper.

- **[Auto-AB] key:**
Automatically detects the appropriate AB paper size when loading paper such as A4 or B5.
- **[Auto-Inch] key:**
Automatically detects the appropriate inch paper size when loading paper such as 8-1/2"x11".
- **[Size Set] key:**
Tap this key to manually specify the paper size that is not detected automatically.
- **[Direct Entry] key:**
Tap this key to enter a numeric value for the size of the loaded paper.

After the settings are completed, tap **OK**.



To directly enter a paper size

Tap the [inch] key to set a paper size in inches, or tap the [AB] key to set it in millimeters.
After you have entered the paper size using the **- +** key, tap the [OK] key.

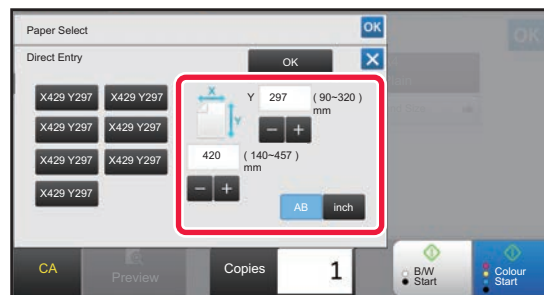



OUTPUT

SORT/GROUP SETTING

This section explains how to select the sorting method when outputting the scanned original.

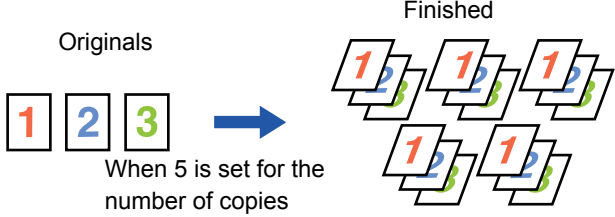
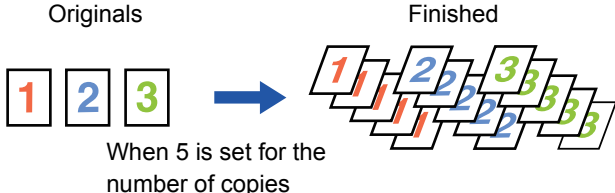
Auto	Enables the sort mode when the original is placed in the automatic document feeder, and enables the group mode when the original is placed on the document glass.	
Sort	Sorts the scanned original on a set basis, and outputs them.	
Group	Groups the scanned original on a page basis, and outputs them.	

1

Tap the [Detail] key to change to normal mode.

► [Changing mode from each mode \(page 2-5\)](#)



Tap the [Original] key and specify the orientation of the original to have the orientation be correctly recognized.

► [Specifying the orientation of the original \(page 2-33\)](#)

2

Tap the [Sort/Group] key.



If a finisher or saddle stitch finisher is installed, tap the [Sort/ Group] key in [Others].

3

Select the sorting method.

After the settings are completed, tap **OK**.



• You can select the offset output checkbox to have each set of output be offset from the previous set to enable easy removal from the output tray.

• To change the output tray, tap the [Output Tray] key, and select the output destination.



STAPLE SETTINGS

Specify whether or not the set of output will be stapled.

Original Orientation	Staple	Staple Position		
		Left	Top	Right
-	OFF	Does not staple.		
Portrait orientation	1 Staples			
	2 Staples			
	Stapleless Staple			
Landscape orientation	1 Staples			
	2 Staples			
	Stapleless Staple			



- You can view staple positions on the "[PREVIEW SCREEN \(page 1-17\)](#)". Text will be printed at the preset size regardless of the copy ratio or paper size setting.
- To change the default staple position:
In "Settings (administrator)", select [System Settings] → [Copy Settings] → [Initial Status Settings] → [Staple Position].



- An inner finisher, finisher, finisher (large stacker), saddle stitch finisher or saddle stitch finisher (large stacker) is required to use the staple function.
- A saddle stitch finisher or saddle stitch finisher (large stacker) is required to use the saddle stitch function.
- An inner finisher, finisher (large stacker) or saddle stitch finisher (large stacker) is required to use the stapleless staple.



Staple ON (excluding booklet)

1

Tap the [Staple / Punch] key.

▶ [COPY MODE \(page 2-3\)](#)



Tap the [Original] key and specify the orientation of the original to have the orientation be correctly recognized.

▶ [Specifying the orientation of the original \(page 2-33\)](#)

2

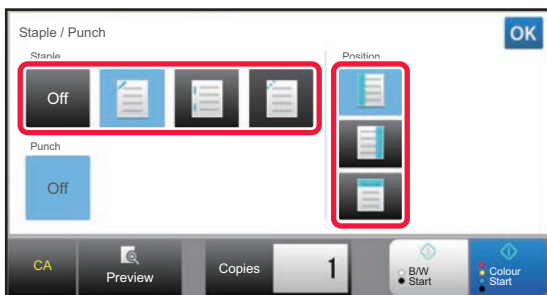

Select the number of staples and staple position.

- After the settings are completed, tap **OK**.
- A binding position cannot be selected for stapleless stapling.



In normal mode

- Tap the [Staple Sort] key.

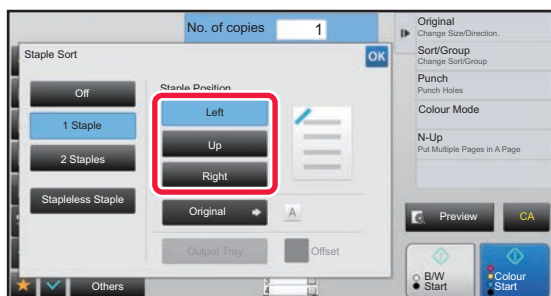

- If you need to change the output tray, tap the [Output Tray] key and select the output destination before selecting stapling.
- If the number of scanned originals exceeds the staple sheet limit, a message is displayed. Tap [Continue] or [Cancel].
[Continue]: Continues sorting without stapling.
[Cancel]: Cancels the staple sort setting.



Saddle Stitch

1

Tap the [Staple / Punch] key.

► [COPY MODE \(page 2-3\)](#)



Tap the [Original] key and specify the orientation of the original to have the orientation be correctly recognized.

► [Specifying the orientation of the original \(page 2-33\)](#)

2

Select .

After the settings are completed, tap .

3

Select binding edge and original settings.

► [MAKING COPIES IN PAMPHLET FORMAT \(BOOKLET\) \(page 2-61\)](#)

After the settings are completed, tap .



In normal mode

- If you need to change the output tray, tap the [Output Tray] key and select the output destination before selecting stapling.
- If [Booklet] is already specified in [Others], you do not need configure binding edge and cover settings.
- If [Booklet] is specified in [Others], the saddle stitch screen appears. Confirm the message shown on the screen, and tap the [On] key. (If you select "Settings (administrator)" → [System Settings] → [Common Settings] → [Device Control], then set the [Automatic Saddle Stitch] check box to)
- If the number of scanned originals exceeds the staple sheet limit, a message is displayed. Tap [Divide], [Continue] or [Cancel].
[Divide]: Divides the pages into sets that can be stapled and sorts them.
[Continue]: Continues sorting without stapling.
[Cancel]: Cancels the staple sort setting.



PUNCH SETTINGS

This function punches copies and outputs them to the tray.

Example

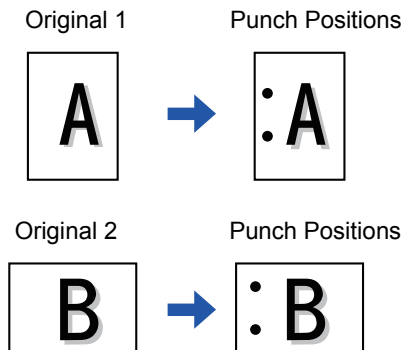

Original Orientation	Punch Position		
	Left	Top	Right
OFF	Does not punch.		
Portrait orientation			
Landscape orientation			



- To change the default punch settings:
In "Settings (administrator)", select [System Settings] → [Copy Settings] → [Initial Status Settings] → [Punch].
- Punch positions are linked to staple positions.



- You can view punch positions on the "[PREVIEW SCREEN \(page 1-17\)](#)".
- A punch module is required for paper punch.
- You cannot use A3W (12" x 18") size paper or special media such as transparency film and tab paper.
- You cannot use a paper punch together with the staple and paper folding.



1

Tap the [Staple / Punch] key.

- ▶ [COPY MODE \(page 2-3\)](#)



Tap the [Original] key and specify the orientation of the original to have the orientation be correctly recognized.

- ▶ [Specifying the orientation of the original \(page 2-33\)](#)

2

Select punching and set the position.

After the settings are completed, tap .



In normal mode

- You can select the offset output checkbox to have each set of output be offset from the previous set to enable easy removal from the output tray.
- To change the output tray, tap the [Output Tray] key, and select the output destination.



FOLD SETTING

This function is used to fold copies before delivery to the output tray.

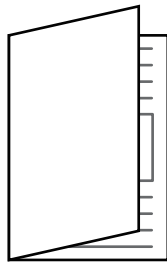

Fold Inside



Fold Outside



- To change the default fold setting:
In "Settings (administrator)", select [System Settings] → [Copy Settings] → [Initial Status Settings] → [Fold].



- A saddle stitch finisher or saddle stitch finisher (large stacker) is required to use the fold function.
- The fold function cannot be used in combination with the staple function and punch function.
- The folding function cannot be combined with the staple function or punch function.
- You can check the selected folding method in "[PREVIEW SCREEN \(page 1-17\)](#)".

1

Tap the [Detail] key to change to normal mode.

- ▶ [Changing mode from each mode \(page 2-5\)](#)



Tap the [Original] key and specify the orientation of the original to have the orientation be correctly recognized.

- ▶ [Specifying the orientation of the original \(page 2-33\)](#)

2

Tap the [Others] key, and tap the [Fold] key.

3

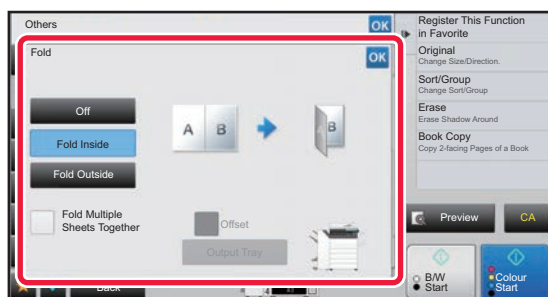

Select the folding method.

After the settings are completed, tap **OK**.



INSERTING SEPARATOR PAGES BETWEEN COPIES OR JOBS

This function inserts separator pages between each set of copies or between each job.

When you insert separator pages between sets of copies, you can specify whether to insert the separator page before or after each set. You can also specify the number of copies that makes one set.

When you insert separator pages between jobs, you can specify whether to insert a separator page before or after each job.

Separator page insertion examples

In the following examples, four copies of a two-page original are output.

Inserting a separator page before each set of two copies

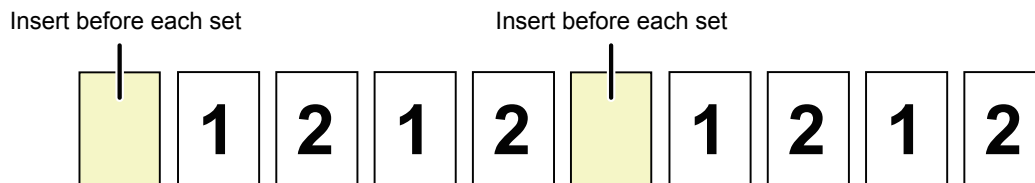

Inserting a separator page after each set of two copies

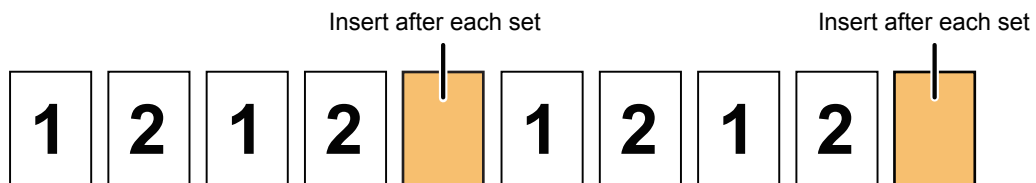

Inserting separator pages before and after a job



- When this function is combined with Sort/Group and Staple/Punch, Sort/Group and Staple/Punch are not applied to the separator pages.
- This function cannot be used with the saddle stitch or fold function.
- When used in combination with the offset function, a separator page is never offset by itself; the separator page is always offset together with the set of output.

1

Tap the [Detail] key to change to normal mode.

► [Changing mode from each mode \(page 2-5\)](#)



Tap the [Original] key and specify the orientation of the original to have the orientation be correctly recognized.

► [Specifying the orientation of the original \(page 2-33\)](#)

2

Tap the [Others] key, and tap the [Separator Page] key.



3

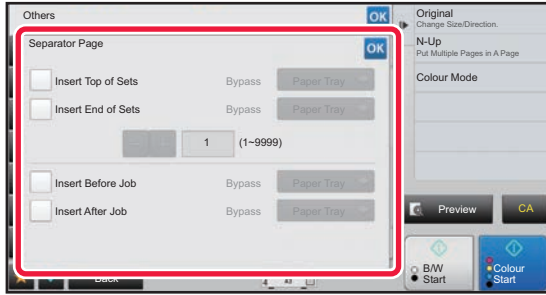

Specify the separator page insertion mode.

- To insert separator pages between sets of copies, set the [Insert Top of Sets] or [Insert End of Sets] checkbox to . Next, tap **- +** to specify the number of copies in each set.
- To insert separator pages between jobs, set the [Insert Before Job] or [Insert After Job] checkbox to .
- After the settings are completed, tap **OK**.



To change the separator page tray:

Tap the [Paper Tray] key to display the tray selection screen. Tap the separator page tray in the tray selection screen. For more information, see "[SELECTING THE PAPER TRAY FOR COPYING \(page 2-13\)](#)" and "[SPECIFYING A TYPE AND SIZE OF PAPER LOADED ON BYPASS TRAY \(page 2-40\)](#)".



To cancel the separator page insertion setting:

Clear the checkmark for separator page insertion mode.



BATCH COPY FUNCTIONS

COPYING MULTIPLE ORIGINALS AS A SINGLE PAGE (N-Up)

This function copies multiple original pages onto a single sheet of paper in a uniform layout.

Select 2-Up to copy two original pages onto one sheet, 4-Up to copy four original pages onto one sheet, or 8-Up to copy eight original pages onto one sheet.

This function is convenient when you wish to present multiple pages in a compact format, or show a view of all pages in a document.

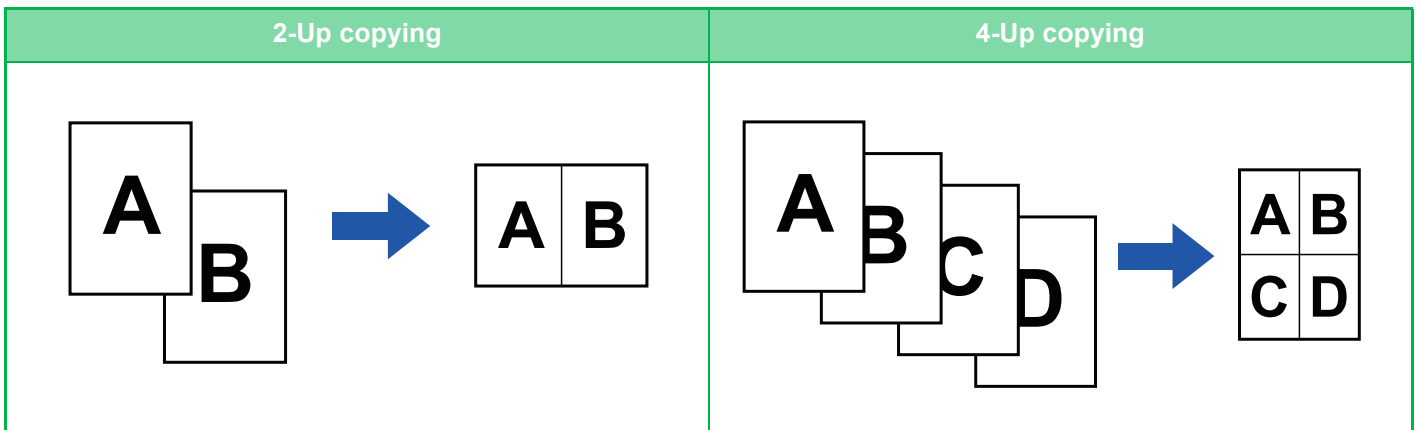

When inserting a cover sheet, select Cover Setting to copy only a front sheet to one page and collectively copy the second and subsequent pages.

1

Place the original.

Place the original in the document feeder tray of the automatic document feeder, or on the document glass.

- ▶ [AUTOMATIC DOCUMENT FEEDER \(page 1-84\)](#)
- ▶ [DOCUMENT GLASS \(page 1-86\)](#)



When using the document glass to scan multiple original pages, change the original and tap the [B/W Start] or [Colour Start] key.

2

Tap the [N-Up] key

- ▶ [COPY MODE \(page 2-3\)](#)



Tap the [Original] key and specify the orientation of the original to have the orientation be correctly recognized.

- ▶ [Specifying the orientation of the original \(page 2-33\)](#)



3

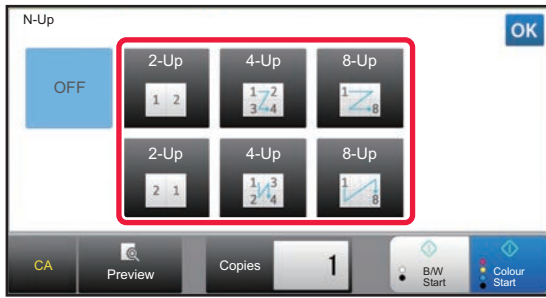

Tap the number of originals you want to copy collectively, and select the layout key.

If needed, the images will be rotated.
If you have finished selecting settings, go to step 7.

4

To select more detailed settings, tap the [Detail] key to switch to normal mode.

► [Changing mode from each mode \(page 2-5\)](#)

5

Tap the [Others] key, and tap the [N-Up] key.

6

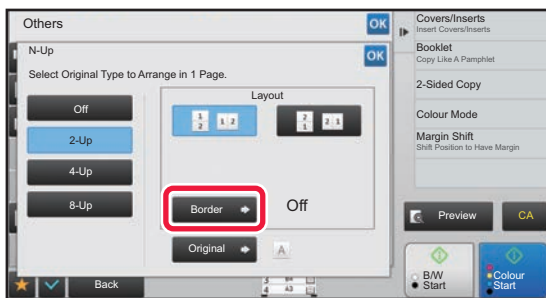

Tap [Border], and select the border.

A line can be inserted between pages arranged on a sheet.
After the settings are completed, tap **OK** twice, and [Back] keys in sequence.



- **To cancel the N-Up setting:**
Tap the [Off] key.
- **To cancel all settings:**
Tap the [CA] key.

7

Tap the [Colour Start] or [B/W Start] key to start copying.



COPYING EACH FACING PAGE OF A BOUND DOCUMENT (DUAL PAGE COPY)

This function copies the left and right half of an original successively. This function is useful when making copies of the facing pages of a book or other bound document.

Copying the facing pages of a book or bound document

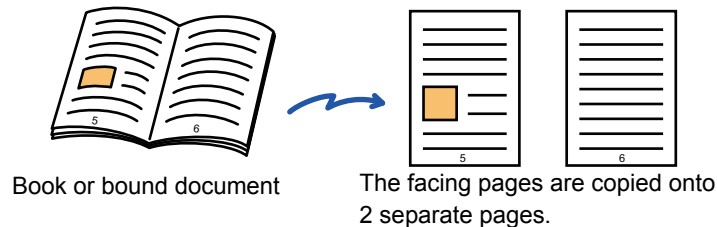

- Specify dual page copy before scanning the original.
- To erase shadows caused by the binding of a book or other bound document, use the erase function. This function cannot be used in combination with Centre Erase.
- This function cannot be used in combination with 2-sided Original and Image Orientation: Horizontal.

1

Tap the [Detail] key to change to normal mode.

- [Changing mode from each mode \(page 2-5\)](#)

2

Tap the [Others] key, and tap the [Dual Page Copy] key.

A checkmark appears on the icon.
After the settings are completed, tap the [Back] key.



When dual page copy is selected, A4 or B5 size paper is automatically selected.
If you want to use paper in another tray, tap the [Paper Select] key and select the tray containing the desired paper from the paper tray selection screen that appears.

- [SELECTING THE PAPER TRAY FOR COPYING \(page 2-13\)](#)



To cancel the dual page copy setting:

Tap the [Dual Page Copy] key to uncheck it.



3

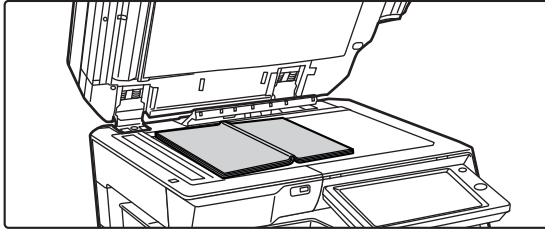

Place the original on the document glass.

► [DOCUMENT GLASS \(page 1-86\)](#)

Align the centre of the original with the appropriate size mark

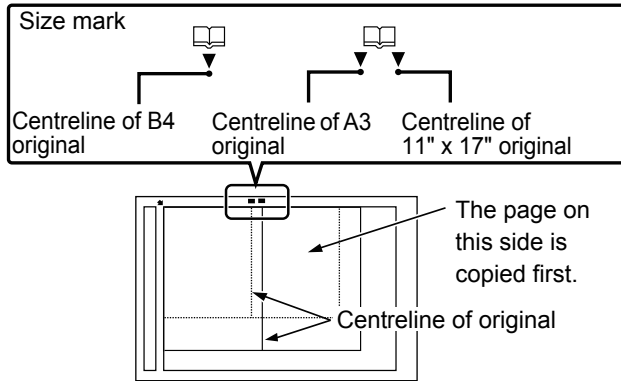

To cancel all settings:
Tap the [CA] key.

4

Tap the [Colour Start] or [B/W Start] key to start copying.



COPYING BOTH SIDES OF A CARD AS A SINGLE PAGE (CARD SHOT)

This function copies the front and reverse sides of a card on one sheet, not on separate sheets. This function is convenient for making copies for identification purposes and helps save paper.

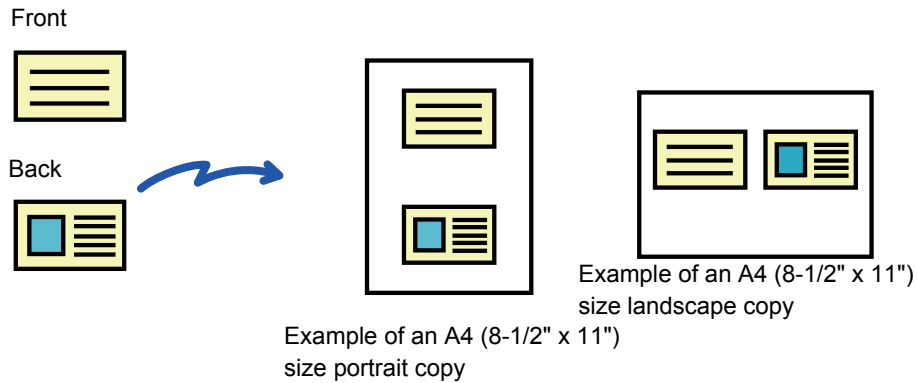

To change the default original size during Card Shot:

In "Settings (administrator)", select [System Settings] → [Copy Settings] → [Condition Settings] → [Card Shot Settings].

1

Tap the [Detail] key to change to normal mode.

► [Changing mode from each mode \(page 2-5\)](#)

2

Select the paper to be used for card shot.

Set a paper by referring to the "[SELECTING THE PAPER TRAY FOR COPYING \(page 2-13\)](#)".

3

Tap the [Others] key, and tap the [Card Shot] key.

4

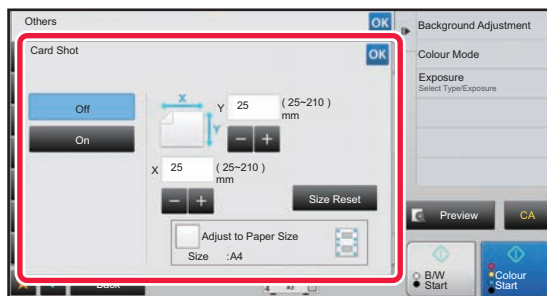

Tap the [On] key, and specify the original size as required.

After the settings are completed, tap **OK** and [Back] keys in sequence.



- Tap the areas displaying width and height sizes respectively, and enter the sizes using the numeric keys.
- To quickly set the size, first specify a value close to the desired ratio value by the numeric keys, then adjust it by tapping **-** **+**.
- When you set the [Adjust to Paper Size] checkbox to , the original is enlarged or reduced with the ratio appropriate to the original size.



To cancel the Card Shot settings:

Tap the [Off] key.

5

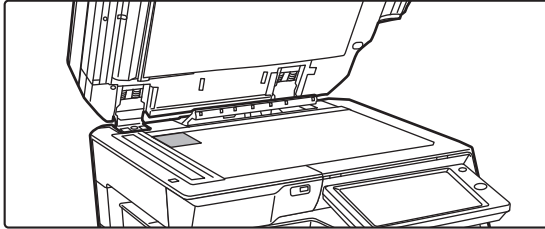

Place a card face down on the document glass, and tap the [Colour Start] or [B/W Start] key.

► [DOCUMENT GLASS \(page 1-86\)](#)

6

Place a card face up on the document glass, and tap the [Colour Start] or [B/W Start] key to scan the reverse side.



- Copy settings cannot be changed when scanning additional pages.
- **To cancel all settings:**
Tap the [CA] key.

7

Tap the [Read-End] key to start copying.



REPEATING THE SAME IMAGE ON ONE SHEET (REPEAT LAYOUT)

This function copies multiple same original images on one sheet.
You can set any of the following three types of repeat copy.

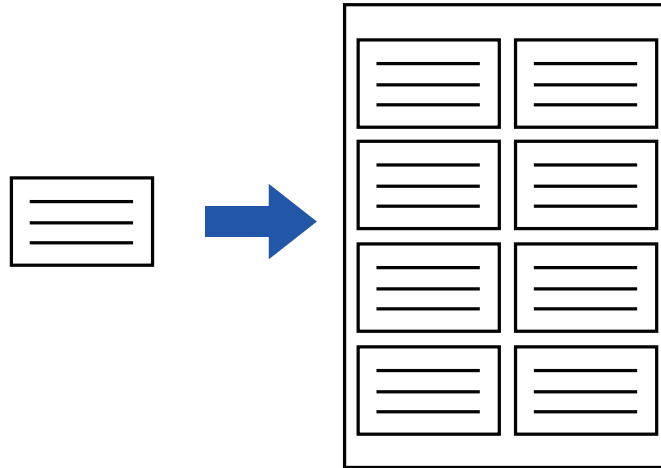

Repeat method	Description
Auto Repeat	The maximum repeat count to copy images on a sheet is calculated automatically according to the original size, paper size, and copy ratio being selected from the base screen.
Fixed Repeat	When you select a repeat count, original size, and paper size to copy images on a sheet, the copy ratio is calculated automatically and the original is copied.
Photo Repeat	This function repeatedly copies on A4 (8-1/2" x 11") or A3 (11" x 17") papers without changing the copy ratio of the photo size original. You can select any of the following five types of original size: <ul style="list-style-type: none"> • E/L Size, Postcard (Up to 148 mm x 105 mm (3" x 5")) • Up to 100 mm x 150 mm (5" x 7") • Card (Up to 70 mm x 100 mm (2-1/2" x 4")) • ID Photo (Up to 65 mm x 70 mm (2-1/2" x 2-1/2")) • Card (Up to 57 mm x 100 mm (2-1/8" x 2-5/8"))



- Repeat Layout must be specified before scanning the original.
- If the copy ratio automatically obtained in [Fixed Repeat] exceeds 25 to 400% (using document glass) or 25 to 200% (using automatic document feeder), it will result in an error. Select the number of faces to repeat again.
- Always place an original on the document glass for photo repeating.
- Repeat Layout can be combined with Staple / Punch or Saddle Stitch.



- This function cannot be combined with Mixed Size Original or 2-Sided Copy.
- Photo Repeat cannot be combined with Image Orientation.



Copy by automatically calculating the repeat count (Auto Repeat)

1

Place the original.

Place the original in the document feeder tray of the automatic document feeder, or on the document glass.

- ▶ [AUTOMATIC DOCUMENT FEEDER \(page 1-84\)](#)
- ▶ [DOCUMENT GLASS \(page 1-86\)](#)

2

Tap the [Detail] key to change to normal mode.

- ▶ [Changing mode from each mode \(page 2-5\)](#)

3

Tap the [Others] key, and then tap the [Repeat Layout] key.

4

Tap the [Auto Repeat] key.

5

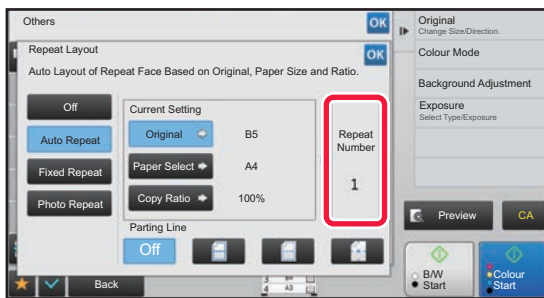

Check the repeat faces which have been calculated automatically.

Change the original size, paper size, or copy ratio by tapping the respective [Original], [Paper Select], or [Copy Ratio] key when necessary.

- ▶ [SELECTING THE ORIENTATION AND SIZE OF THE ORIGINAL \(page 2-33\)](#)
- ▶ [MANUAL RATIO SELECTION \(page 2-27\)](#)
- ▶ [SELECTING THE PAPER TRAY FOR COPYING \(page 2-13\)](#)



Set so that there are one or more repeat faces.

6

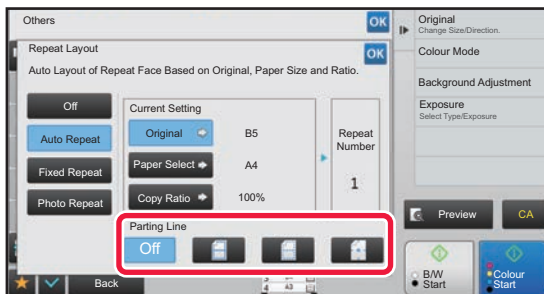

Specify the repeat partition line.

After the settings are completed, tap **OK** and [Back] keys in sequence.



- To cancel the Auto Repeat setting:
Tap the [Off] key.
- To cancel all settings:
Tap the [CA] key.



7 Tap the [Colour Start] or [B/W Start] key to start copying.

Copy by specifying a repeat count (Fixed Repeat)

1

Place the original.

Place the original in the document feeder tray of the automatic document feeder, or on the document glass.

- ▶ [AUTOMATIC DOCUMENT FEEDER \(page 1-84\)](#)
 - ▶ [DOCUMENT GLASS \(page 1-86\)](#)
-

2

Tap the [Detail] key to change to normal mode.

- ▶ [Changing mode from each mode \(page 2-5\)](#)
-

3

Tap the [Others] key, and then tap the [Repeat Layout] key.

4

Tap the [Fixed Repeat] key.

5

Tap the [Original] and [Paper Select] keys to select an original size and a paper size, respectively.

- ▶ [SELECTING THE ORIENTATION AND SIZE OF THE ORIGINAL \(page 2-33\)](#)
- ▶ [SELECTING THE PAPER TRAY FOR COPYING \(page 2-13\)](#)



6

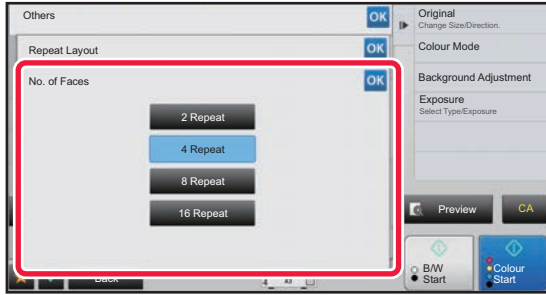

Tap [No. of Faces] to set a repeat count.

After the settings are completed, tap **OK**.
The automatic calculation result is shown as the copy ratio.



If the calculated copy ratio exceeds the range from 25% to 400% (using document glass) or 25 to 200% (using automatic document feeder), an error occurs.

7

Specify the repeat partition line.

After the settings are completed, tap **OK** and [Back] keys in sequence.



- **To cancel the fixed repeat setting:**
Tap the [Off] key.
- **To cancel all settings:**
Tap the [CA] key.

8

Tap the [Colour Start] or [B/W Start] key to start copying.

Repeat a photo size original in actual size (Photo Repeat)

1

Tap the [Detail] key to change to normal mode.

► [Changing mode from each mode \(page 2-5\)](#)

2

Tap the [Others] key, and then tap the [Repeat Layout] key.

3

Tap the [Photo Repeat] key.

4

Place the original on the document glass.



5

Tap the [Original] key and select an original size.

When you tap the original size key, the original direction is indicated in the "How To Set". Place the original to meet the displayed orientation.

After the settings are completed, tap **OK**.

6

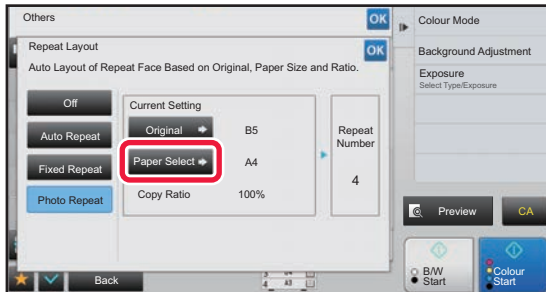

Tap the [Paper Select] key and select a paper size.

After the settings are completed, tap **OK** and [Back] keys in sequence.

The automatic calculation result is shown as the copy ratio.



When you tap the [*Up to 57x100mm(Card) *~ 2 1/8 x 2 5/8"] key on the [Original] screen, you can select the A4 paper size only.



- **To cancel the photo repeat setting:**
Tap the [Off] key.
- **To cancel all settings:**
Tap the [CA] key.

7

Tap the [Colour Start] or [B/W Start] key to start copying.



OTHER FUNCTIONS

Other functions are set from the base screen of normal mode.

▶ [SELECTING COPY MODE \(page 2-4\)](#)



Other functions cannot be selected in easy mode.

OUTPUT AND LAYOUT EDITING FUNCTIONS

MAKING COPIES IN PAMPHLET FORMAT (BOOKLET)

Copies made by "Booklet" can be folded at the centre to create a booklet.
This function is convenient for arranging copies into an attractive booklet or pamphlet.

Booklet copy using 8 original pages

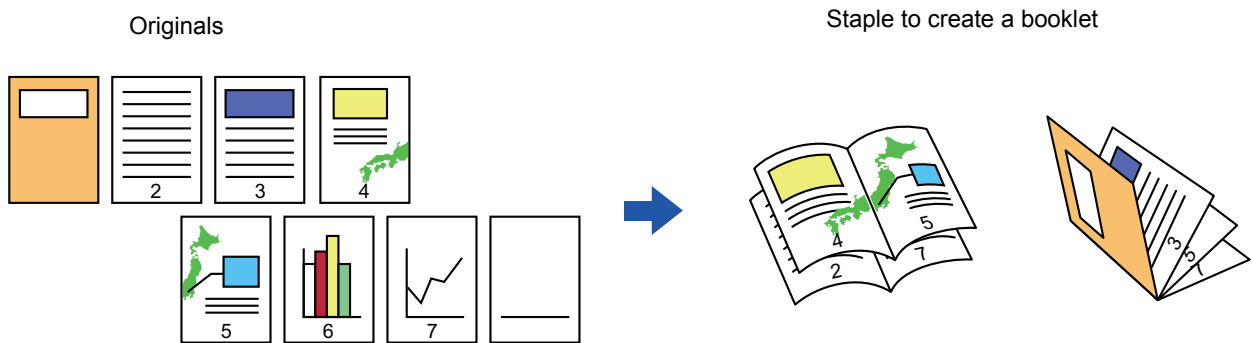

Binding side

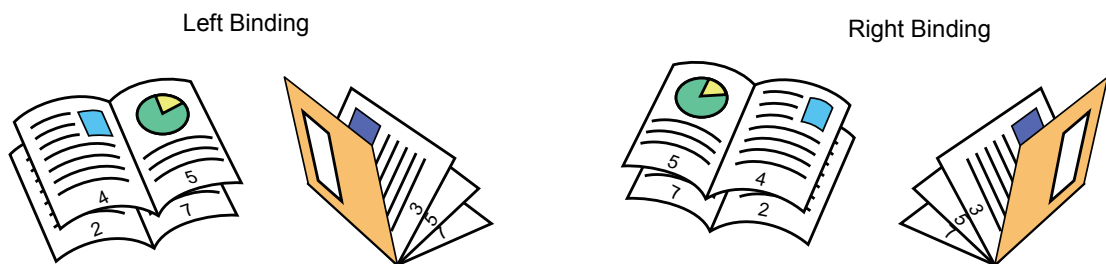



- To make Booklet copies of a book or other bound original, use the book copy function.
 - ▶ [COPYING A PAMPHLET \(BOOK COPY\) \(page 2-67\)](#)
- When Booklet is selected, 2-sided copying mode is automatically selected. When settings are selected that prevent 2-sided copying, the booklet function cannot be used.
- Scan the originals in order from the first page to the last page. The order of copying will be automatically adjusted by the machine. Four original pages will be copied onto each sheet of paper. Blank pages will be automatically produced at the end of pamphlet copies if the number of original pages is not a multiple of four.
- When a saddle stitch finisher is installed, you can select [Staple Sort] and set the Saddle Stitch (Staple each set of copies at two positions in the centre of paper).
 - ▶ [STAPLE SETTINGS \(page 2-42\)](#)



To staple copies automatically when Booklet is enabled:

From the "Settings (administrator)", select [System Settings] → [Common Settings] → [Device Control] → [Automatic Saddle Stitch].

This is used to activate Saddle Stitch automatically when Booklet is enabled when a saddle stitch finisher is installed. To make pamphlet copies without stapling when the [Automatic Saddle Stitch] option is ON, tap the [Staple Sort] key. Then, select [Booklet] and tap the [Off] key on the saddle stitch screen.

1

Place the original.

Place the original in the document feeder tray of the automatic document feeder, or on the document glass.

- ▶ [AUTOMATIC DOCUMENT FEEDER \(page 1-84\)](#)
- ▶ [DOCUMENT GLASS \(page 1-86\)](#)



If the originals are 2-sided, place them in the document feeder tray.

2

Tap the [Others] key and then the [Booklet] key, or tap the [Staple Sort] key and then the [Saddle Stitch] key.

3

Select the binding edge.



To cancel the booklet setting:

Tap the [Off] key.

4

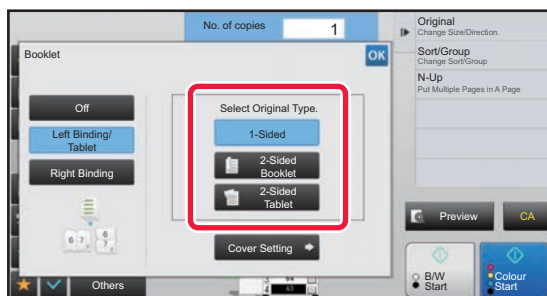

Tap the [1-Sided], [2-Sided Booklet] or [2-Sided Tablet] key as appropriate for the original.

When not inserting a cover, go to step 6.



5

When inserting a cover, tap the [Cover Setting] key, and tap the [On] key.

After the settings are completed, tap  and [Back] keys in sequence.



To change the cover input tray:

Tap the [Paper Tray] key to display the tray selection screen.

Tap the cover input tray on the tray selection screen.

For more information, see "[SELECTING THE PAPER TRAY FOR COPYING \(page 2-13\)](#)".



- If the cover will be copied on, label sheets, transparency film, and tab paper cannot be used.

To cancel all settings:

Tap the [CA] key.

6

Tap the [Colour Start] or [B/W Start] key to start copying.



COPYING MULTIPLE ORIGINALS ON EACH BOOKLET PAGE (BOOKLET 2-Up/4-Up)

This function copies two or four original pages equally on one page of pamphlet copy paper.

This function is convenient for arranging minimum number of copies into an attractive booklet or pamphlet format.

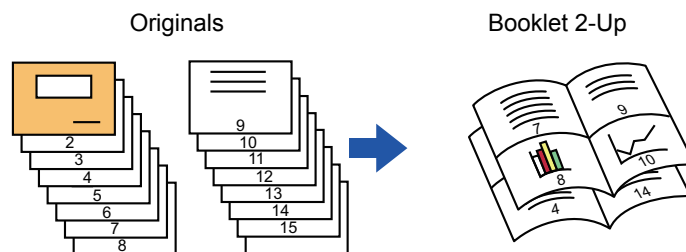

- The following paper sizes and number of sheets are available for booklet 2-Up or 4-Up.

Paper size: A3W, A3, B4, A4R, B5R, 12"x 18", 11"x 17", 8-1/2"x 14", 8-1/2"x 11"R

Number of stapled sheets: Max. 15 sheets

- Scan the originals in order from the first page to the last page. The order of copying will be automatically adjusted by the machine.

Eight or 16 original pages will be copied onto each sheet of paper. Blank pages will be automatically produced at the end if the number of original pages is not a multiple of eight.

1

Place the original.

Place the original in the document feeder tray of the automatic document feeder, or on the document glass.

► [AUTOMATIC DOCUMENT FEEDER \(page 1-84\)](#)

► [DOCUMENT GLASS \(page 1-86\)](#)



If the originals are 2-sided, place them in the document feeder tray.

2

Tap the [Staple Sort] key, and tap the [Saddle Stitch] key.

3

Select the binding edge.



To cancel the booklet setting:

Tap the [Off] key.



4

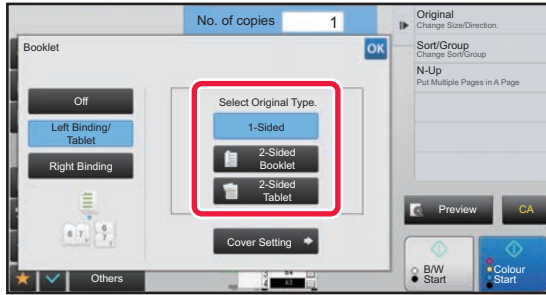

Tap the [1-Sided], [2-Sided Booklet] or [2-Sided Tablet] key as appropriate for the original.

When not inserting a cover, go to step 6.

5

When inserting a cover, tap the [Cover Setting] key, and tap the [On] key.



- To change the cover input tray:
Tap the [Paper Tray] key to display the tray selection screen.
Tap the cover input tray on the tray selection screen.
For more information, see "[SELECTING THE PAPER TRAY FOR COPYING \(page 2-13\)](#)".
- To make a copy on a cover sheet, check the [Make Copy on Cover (Duplex)] box so that appears.



- If the cover will be copied on, label sheets, transparency film, and tab paper cannot be used.
- To cancel all settings:
Tap the [CA] key.

6

Tap [N-Up] on the action panel.

7

Tap the key of the N-Up sheets you wish to use.

If needed, the images will be rotated.



- To cancel the N-Up setting
Tap the [Off] key.

8

Select the layout.



9

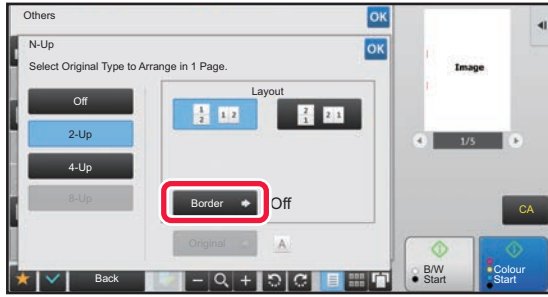

Tap [Border], and select the border.

A line can be inserted between pages arranged on a sheet. After the settings are completed, tap **OK** twice, and [Back] keys in sequence.



To cancel all settings:
Tap the [CA] key.

10

Tap the [Colour Start] or [B/W Start] key to start copying.



COPYING A PAMPHLET (BOOK COPY)

This function makes a copy of the two facing pages of an open book or other bound document. Copies made with this function can be folded at the centre to create a booklet. This function is convenient for arranging copies into an attractive booklet or pamphlet.

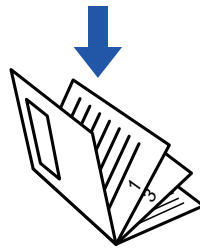
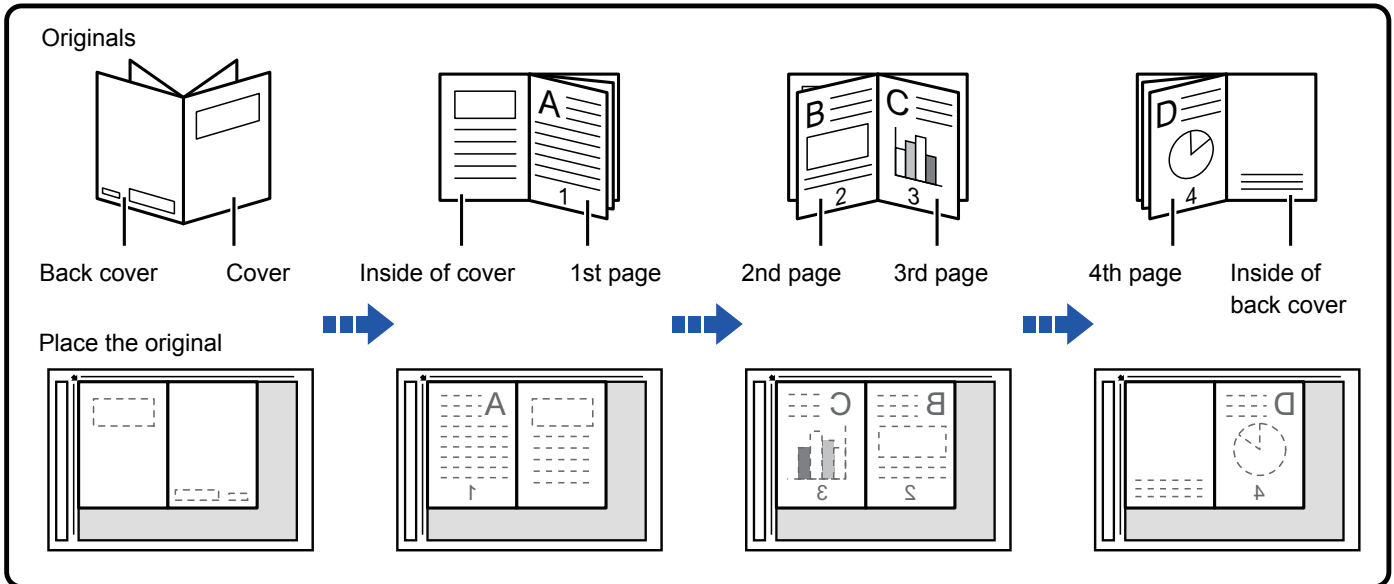

- Book Copy must be specified before scanning the original.
- Four original pages will be copied onto each sheet of paper. Blank pages will be automatically added at the end if the total number of original pages is not a multiple of four.
- This function can be combined with saddle stitch or fold if a saddle stitch finisher is installed.
- When the book copy function is selected, 2-sided copying mode is automatically selected. When settings are selected that prevent 2-sided copying, the book copy function cannot be used.

1

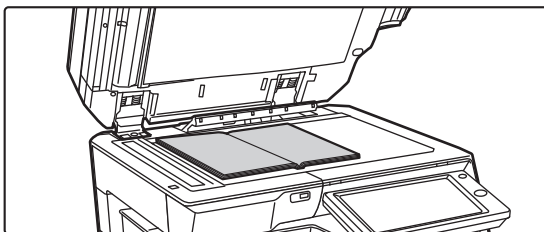

Place the original on the document glass.

Place the opened pages of the "front and last sheets".
 ► [DOCUMENT GLASS \(page 1-86\)](#)

2

Tap the [Others] key, and tap the [Book Copy] key.



3

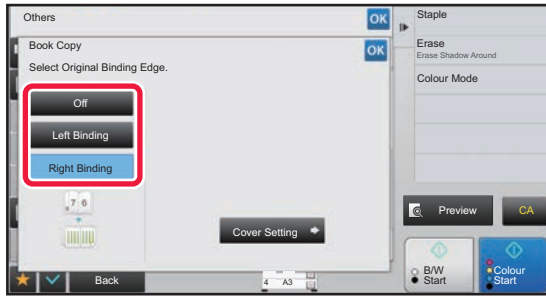

Select a binding position.

When not inserting a cover, tap the **OK** and [Back] keys in sequence. Then, go to step 5.



To cancel the book copy setting:
Tap the [Off] key.

4

When inserting a cover, tap the [Cover Setting] key, and tap the [On] key.

To make a copy on the inserted cover sheet, check the [Make Copy on Cover (Duplex)] box so that appears. After the settings are completed, tap **OK** and [Back] keys in sequence.



To change the cover input tray:

Tap the [Paper Tray] key to display the tray selection screen. Tap the cover input tray on the tray selection screen. For more information, see "[SELECTING THE PAPER TRAY FOR COPYING \(page 2-13\)](#)".



- If the cover will be copied on, label sheets, transparency film, and tab paper cannot be used.
- This setting is not available when the covers/inserts function is disabled in the setting mode.

5

Tap the [Colour Start] or [B/W Start] key to scan the first original page.

Scanning of the original starts.

6

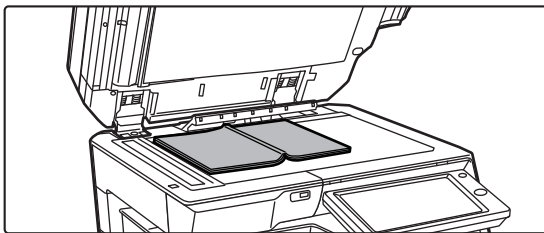

Place the next opened original pages, and tap the [Colour Start] or [B/W Start] key.

Tap the same key you tapped in step 5.
Repeat this step until all original pages have been scanned.
Scan the remaining original pages in the following order:
Inside of the front cover and the 1st page (facing pages)
The 2nd and 3rd pages (facing pages)
⋮
The last page and inside of back cover (facing pages)



- Copy settings cannot be changed when scanning additional pages.
- **To cancel all settings:**
Tap the [CA] key.

7

Tap the [Read-End] key to start copying.



SPLITTING A PAMPHLET ORIGINAL BY PAGE (BOOK DIVIDE)

This function splits a saddle-stitch original such as a catalogue or a pamphlet page by page, and copies in sequence.

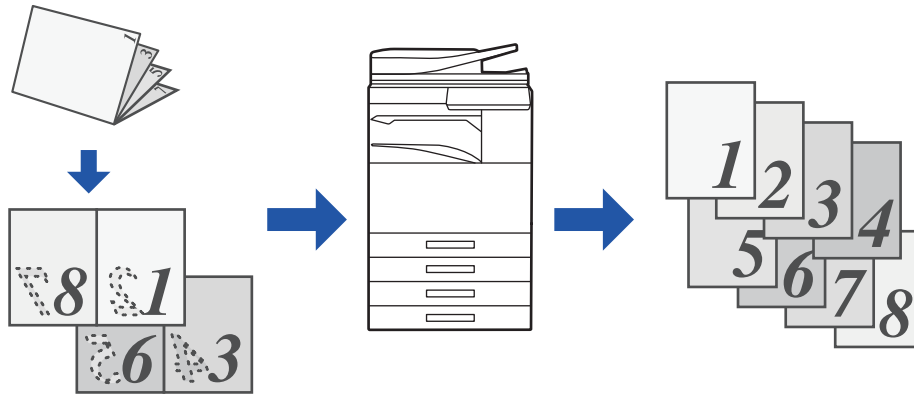

- Book Divide must be specified before scanning the original.
- This function supports three original binding edges: left binding, right binding, and top open.
- The scanned original is split in the centre.



The document glass is not available for this function.

1

Tap the [Others] key, and tap the [Book Divide] key.

2

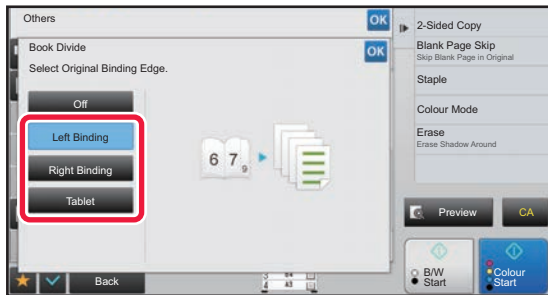

Select the binding edge of the pamphlet original.



Check the preview image displayed in the screen, and make sure that the binding edge is correct.



- **To cancel the Book Divide setting:**
Tap the [Off] key.
- **To cancel all settings:**
Tap the [CA] key.

3

Tap the [Colour Start] or [B/W Start] key to start copying.



PAPER, AND TIME SAVING FUNCTIONS

SKIPPING BLANK PAGES IN AN ORIGINAL (BLANK PAGE SKIP)

If the scanned original contains blank pages, this function skips them to copy only non-blank pages. The machine detects blank pages, enabling you to skip useless copies without checking an original.

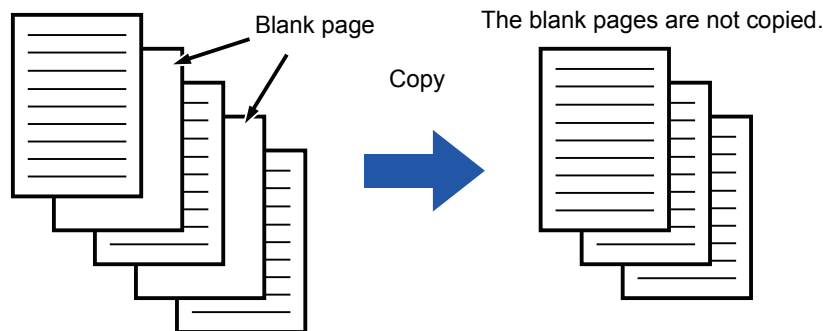

- If an original of which one side is blank is scanned, blank pages are skipped for 2-sided copying.
- Depending on the original, some pages that are not blank may be detected as blank pages and thus not being copied, and some pages that are blank may not be detected as blank and thus copied.

1

Place the original.

Place the original in the document feeder tray of the automatic document feeder, or on the document glass.

- ▶ [AUTOMATIC DOCUMENT FEEDER \(page 1-84\)](#)
- ▶ [DOCUMENT GLASS \(page 1-86\)](#)

2

Tap the [Others] key, and tap the [Blank Page Skip] key.



3

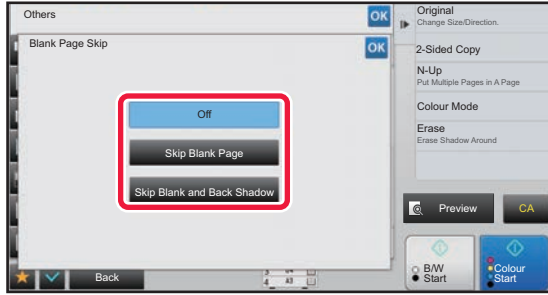

Tap the **[Skip Blank Page]** or **[Skip Blank and Back Shadow]** key.

After the settings are completed, tap **OK** and **[Back]** keys in sequence.



To cancel all settings:

Tap the **[CA]** key.

4

Tap the **[Colour Start]** or **[B/W Start]** key.

5

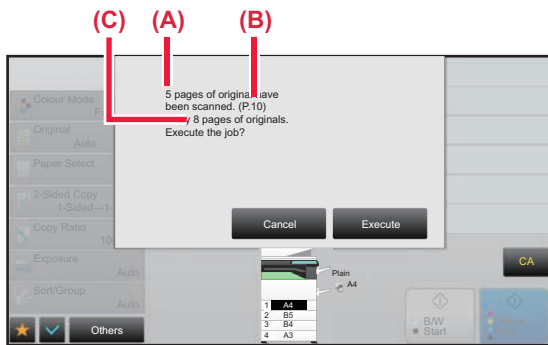

Check the confirmation message, and tap the [Execute] key to start copying.

On the confirmation screen, the number of scanned original sheets appears in (A), the number of scanned sides in (B), and the number of copies excluding blank pages in (C).

For example, if five original sheets that include two blank pages are scanned by duplex scanning, (A) will show "5", (B) will show "10", and (C) will show "8".



ADJUSTING THE BACKGROUND BY MAKING LIGHT AREAS OF THE ORIGINAL DARKER OR LIGHTER (BACKGROUND ADJUSTMENT)

You can adjust the background by making light areas of the original darker or lighter.

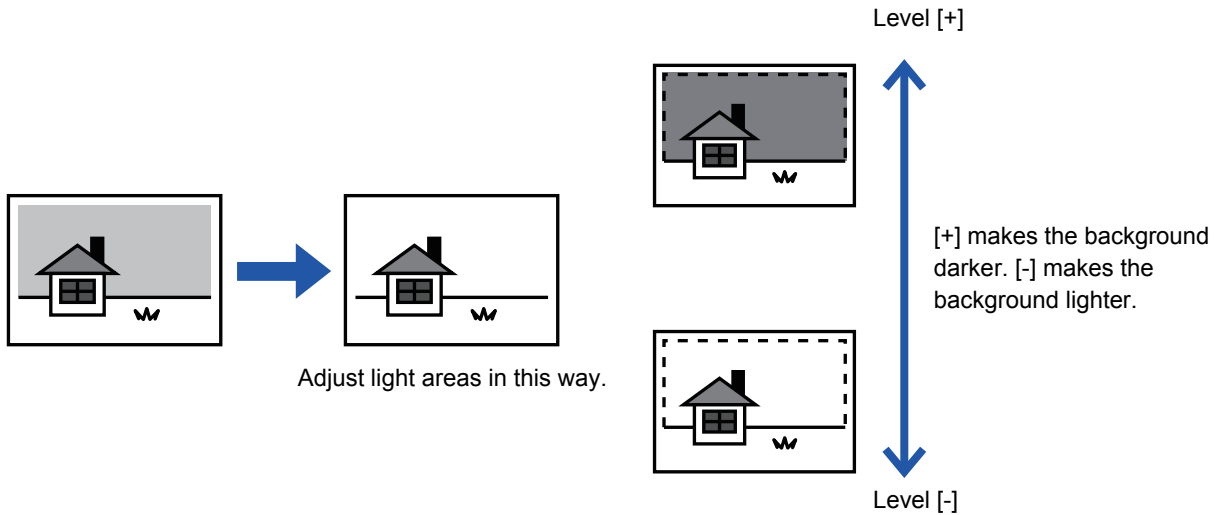

You must select Background Adjustment before scanning the original.

1

Tap the [Others] key, and tap the [Background Adjustment] key.

2

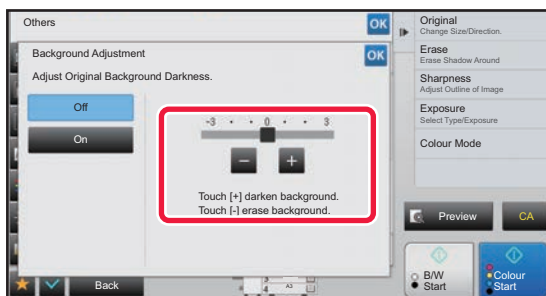

Tap **- +** or move the slider to set the value.

After the settings are completed, tap **OK** and [Back] keys in sequence.



To cancel the Background Adjustment setting:
Tap the [Off] key.



3

Place the original.

Place the original in the document feeder tray of the automatic document feeder, or on the document glass.

- ▶ [AUTOMATIC DOCUMENT FEEDER \(page 1-84\)](#)
- ▶ [DOCUMENT GLASS \(page 1-86\)](#)



To cancel all settings:

Tap the [CA] key.

4

Tap the [Colour Start] or [B/W Start] key to start copying.



MAKING A PROOF COPY (PROOF COPY)

This function makes a proof copy before printing the specified number of copies. Check the preview image with a proof copy. If necessary, change the settings. Using this function stores the scanned original in the machine, saving you the trouble of re-scanning the original in the changed setting.

Proof copy flow

Select "Proof Copy" and set 5 sets of copies

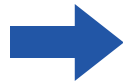
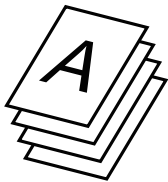

One set of copies is printed for you to check

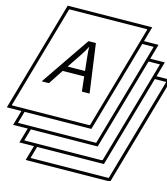

The remaining 4 sets are printed

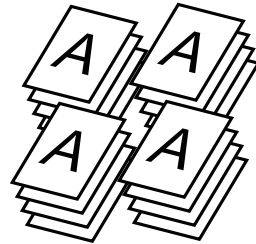

Adjust the settings

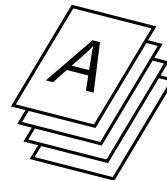

If OK

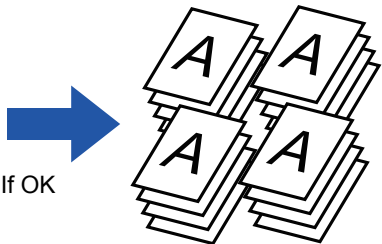

After adjustment, one set is printed for you to check

The remaining 4 sets are printed



- Proof Copy must be specified before scanning the original.
- If Proof Copy is executed while the machine is printing another job, the job in progress is interrupted, and a proof copy is printed preferentially. The interrupted job will resume after proof copying has been completed. However, if proof copy is executed during printing of a job for which both 2-sided printing and staple function are enabled, the proof copy will be printed after the job in progress is finished. If the [Start Print] key is tapped to execute printing of the remaining sets while the machine is printing another job, the remaining sets will be printed after all previously reserved jobs are completed.

1

Tap the [Others] key, and tap the [Proof Copy] key.

A checkmark appears on the icon.

After the settings are completed, tap the [Back] key.



To cancel the Proof copy setting:

Tap the [Proof Copy] key to uncheck it.

2

As necessary, specify the required functions such as "Exposure" and "Copy Ratio".



3

Place the original.

Place the original in the document feeder tray of the automatic document feeder, or on the document glass.

- ▶ [AUTOMATIC DOCUMENT FEEDER \(page 1-84\)](#)
- ▶ [DOCUMENT GLASS \(page 1-86\)](#)



To cancel all settings:

Tap the [CA] key.

4

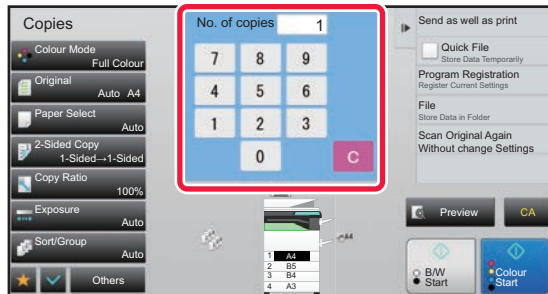

Set the number of copies (number of sets) using the numeric keys.



Up to 9999 copies (sets) can be set.



If an incorrect number of copies is set

Tap the [C] key, and enter the correct number.

5

Tap the [Colour Start] or [B/W Start] key.

Make only one set of copies.



6

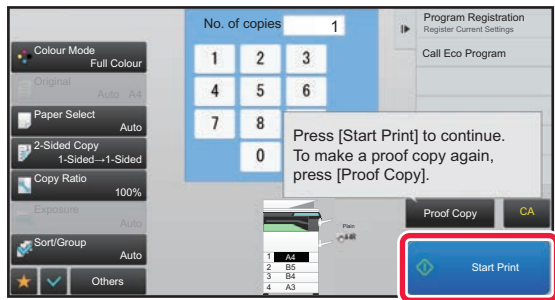

Check the copy result. If no problem is found, tap the [Start Print] key.

As necessary, change the settings and repeat proof copying until you are satisfied with the copy result.



You can also change the number of copies. To change the number of copies, use the numeric keys.



- In Proof Copy, unavailable function keys are not displayed.
- Some available functions may be restricted.
- **To cancel all settings:**
Tap the [CA] key.

7

Tap the [Colour Start] or [B/W Start] key.

CHECKING THE NUMBER OF SCANNED ORIGINAL SHEETS (ORIGINAL COUNT)

This function counts the number of scanned original sheets, and displays the result before making a copy.

By allowing you to check the number of original sheets that were scanned, this helps reduce the occurrence of copy mistakes.



- The count result is displayed with the number of scanned original sheets, not the number of scanned original pages. For example, when 2-sided copying is performed using one original, the number "1" will appear to indicate that one original sheet was scanned, not "2" to indicate the front-side page and the reverse side page.
- Original Count must be specified before scanning the original.

1

Tap the [Others] key, and tap the [Original Count] key.

A checkmark appears on the icon.

After the settings are completed, tap the [Back] key.



To cancel the Original Count setting:

Tap the [Original Count] key to uncheck it.

2

Place the original in the document feeder tray of the automatic document feeder.

- [AUTOMATIC DOCUMENT FEEDER \(page 1-84\)](#)



3 Tap the [Colour Start] or [B/W Start] key.

4

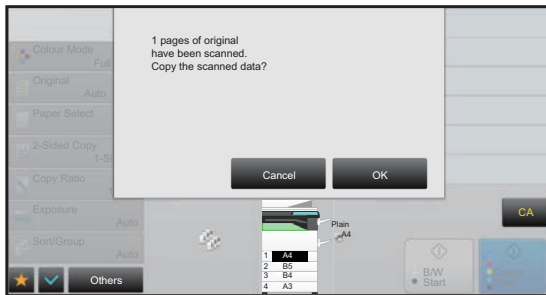

Check the number of original sheets.

The number that is displayed is the number of scanned original sheets, not the number of scanned original pages. For example, when 2-sided copying is performed using one original, the number "1" will appear to indicate that one original sheet was scanned, not "2" to indicate the front-side page and the reverse side page.



If the displayed number of original sheets is different from the actual number of sheets
Tap the [Cancel] key to stop the job.

5

Tap the [OK] key to start copying.



If this function is combined with [Job Build], the count result is displayed after the [Read-End] key has been tapped.



USING TWO MACHINES TO REDUCE THE COPY TIME (TANDEM COPY)

This function shares a copy job half-and-half between two machines connected to the network, enabling the reduction of the copy time.

Master machine and client machine

The master machine performs only scanning, and a client machine registered in the master machine performs only printing without scanning the original.

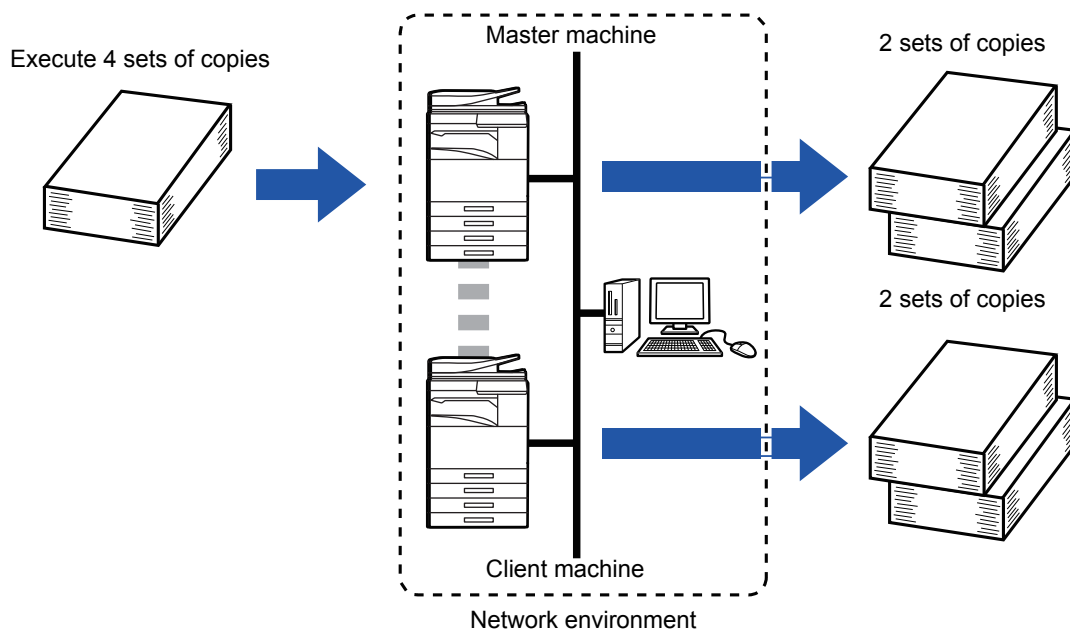

- To use this function, two machines must be connected to your network.
- Even if more machines are connected to the network, this function can only be used to have one other machine share a job.
- To configure the tandem connection setting, register IP address information of the client machine in the master machine. For the port number, it is best to use the initial setting (50001). Unless you experience difficulty with this setting, do not change the port number. The tandem setting should be configured by your network administrator. If the master machine and client machine will switch roles, configure the IP address of the master machine in the client machine. The same port number can be used for both machines.
- In this situation:
 - A saddle stitch finisher is installed in the master machine while not installed in a client machine.
 - Tandem Copy is enabled when specifying copies without stapling.
 - Tandem Copy is disabled when specifying copies with stapling.
 - As shown here, if Tandem Copy is enabled using a function provided in the master machine and not provided in a client machine, a message will appear.
- If a machine runs out of paper
 - If either the master machine or the client machine run out of paper, the machine that ran out of paper will hold the job while the machine that still has paper continues the job. When paper is added to the machine that ran out, the job resumes.
- If user authentication is specified
 - Tandem Copy is enabled when user authentication is specified in the master machine.
 - Tandem Copy is disabled when user authentication is specified in the client machine while it is not specified in the master machine.
- If an odd number of sets is being made, one more set is output to the master machine.



To use Tandem Copy:

In "Settings (administrator)", select [System Settings] → [Common Settings] → [Device Control] → [Tandem Connection Setting].



1

Place the original.

Place the original in the document feeder tray of the automatic document feeder, or on the document glass. When using the document glass to scan multiple original pages, change the original and tap the [B/W Start] or [Colour Start] key.

- ▶ [AUTOMATIC DOCUMENT FEEDER \(page 1-84\)](#)
- ▶ [DOCUMENT GLASS \(page 1-86\)](#)

2

Tap the [Others] key, and tap the [Tandem Copy] key.

A checkmark appears on the icon.
After the settings are completed, tap the [Back] key.



To cancel the Tandem Copy setting:
Tap the [Tandem Copy] key to uncheck it.

3

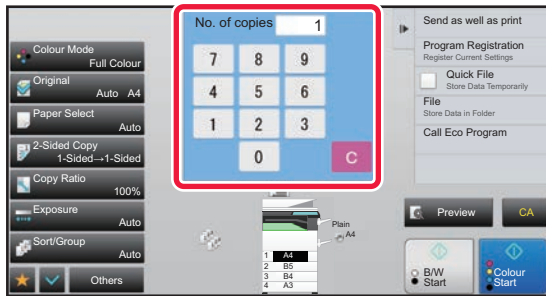

Tap the number of copies key to specify the number of copies.

Up to 9999 copies (sets) can be set. The specified number of copies are shared between the master and client machines. If the number of copies is odd, the master machine makes more copies than the client machine.



- **If an incorrect number of copies is set:**
Tap the [C] key and then enter the correct number.
- **To cancel all settings:**
Tap the [CA] key.

4

Tap the [Colour Start] or [B/W Start] key to start copying.



- **To cancel Tandem Copy:**
Tap the [Cancel Copy] keys on both the master and client machines.



DISPLAYING ECO RECOMMENDATION SETTINGS (ECO RECOMMENDATION FUNCTION DISPLAY)

When the base screen of normal mode is displayed, eco recommendation settings appear.



This function does not operate in easy mode.



To use the eco recommendation function display:

"Settings (administrator)" → [System Settings] → [Energy Save] → [Eco Setting] → [Eco Recommendation Function Display].

The displayed functions are as follows.

- 2-Sided Copy ► [page 2-17](#)
- N-Up ► [page 2-50](#)
- B/W Copy ► [page 2-20](#)
- Image Orientation ► [page 2-33](#)



SECURITY REINFORCEMENT FUNCTIONS

PADDING UNAUTHORIZED COPY PREVENTION DATA (HIDDEN PATTERN PRINT)

Characters to prevent unauthorized copying such as pre-set or customized text are placed as invisible characters in a background pattern.

When an output sheet with a pattern print is copied, the hidden characters will appear.

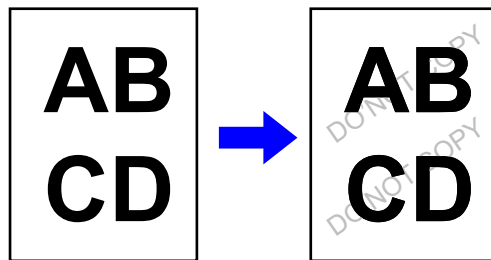

- "Hidden Pattern Print" is a function provided for the purpose of deterring unauthorized copying. It does not guarantee the prevention of information leakage.
- Text may not be completely hidden on an output sheet with a hidden pattern print under certain machine conditions. In such a case, adjust the contrast by selecting the [Hidden Pattern Print Setting] from the "Settings (administrator)".
- When copying an output sheet with a hidden pattern print, the hidden pattern may not emerge depending on settings other than "Hidden Pattern Print".
- The hidden pattern may not emerge on copies with certain types of devices or under certain setting conditions used to copy an output sheet with a hidden pattern print.



To set a Hidden Pattern Print:

In "Settings (administrator)", select [System Settings] → [Security Settings] → [Hidden Pattern Print Setting].

1

Place the original.

Place the original in the document feeder tray of the automatic document feeder, or on the document glass.

- ▶ [AUTOMATIC DOCUMENT FEEDER \(page 1-84\)](#)
- ▶ [DOCUMENT GLASS \(page 1-86\)](#)

2

Tap the [Others] key, and tap the [Hidden Pattern Print] key.



3

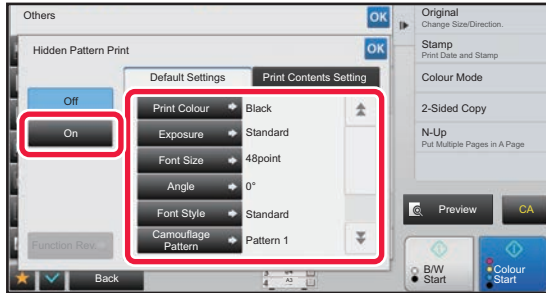

Tap the [On] key, and specify each item in the [Default Settings] tab as required.



- We recommend you to select the [Positive] option for the "Method".
- The black background pattern is printed in the following cases even when you set the [Print Colour] to "Magenta" or "Cyan":
If the colour mode is set to "B/W"
If the black and white mode is determined automatically

4

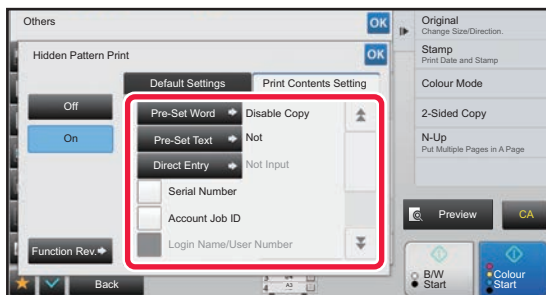

Specify each item in the [Print Contents Setting] tab as required.

To specify print settings, you can select the required one from pre-set text or use the soft keyboard. You can also print serial number and account job ID. After the settings are completed, tap [OK] and [Back] keys in sequence.



- **To cancel the Hidden Pattern Print setting:**
Tap the [Off] key.
- Tapping the [Function Rev.] key displays the settings of the [Print Contents Setting] tab.
- The hidden pattern print preview may slightly differ from the actual pattern and exposure as the preview is used for simple pattern colour checking.
- **To cancel all settings:**
Tap the [CA] key.

5

Tap the [Colour Start] or [B/W Start] key to start copying.



FORCIBLY PRINTING TRACEABLE INFORMATION (TRACKING INFORMATION PRINT)

This function forcibly prints the pre-specified traceable information to prevent an unauthorized copy.

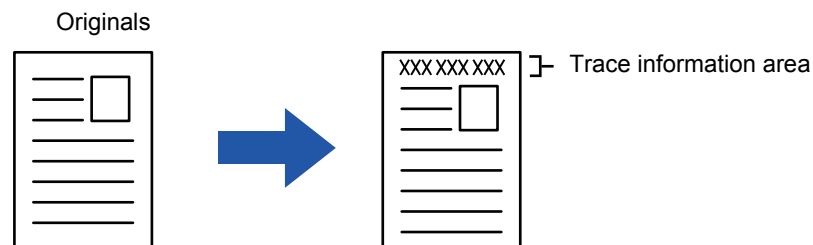

- If this function is specified together with another image compositing function, trace information is printed at the top.
- Trace information is printed at the top or bottom outside an image frame.
- The information added at printing or the preview image of the account job ID and date/time are displayed as shown below.
Account job ID: 00000
Date/time: DD/MM/YYYY hh:mm



To configure print settings:

In "Settings (administrator)", select [System Settings] → [Security Settings] → [Tracking Information Print] → [Tracking Information Print Setting].



OUTPUT POSITION AND MARGIN ADJUSTMENT FUNCTIONS

ADDING MARGINS (MARGIN SHIFT)

This function shifts the copy image right, left or down to adjust the margin.

This is convenient when you wish to bind the copies with a string or in a binder.

Shifting the image to the right so the copies can be bound at the left edge

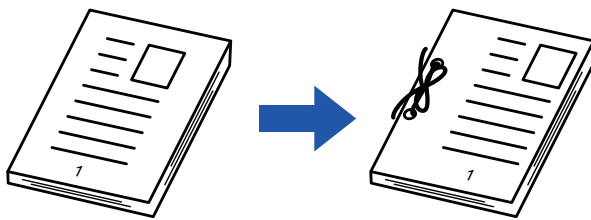

Not using the Margin Shift	Using the Margin Shift
The punch holes cut off part of the image	The image is moved to allow space for the holes so the image is not cut off.

Margin Shift

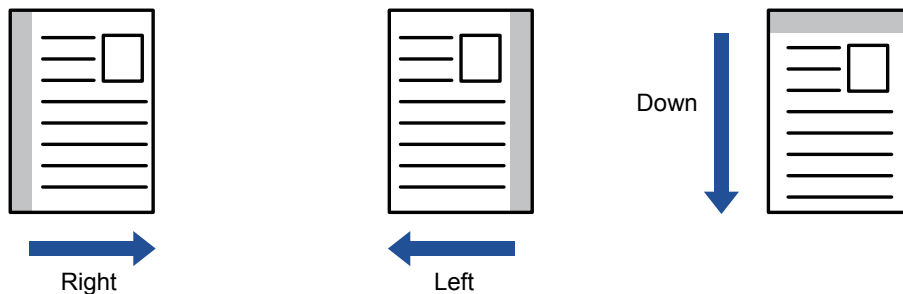

Rotation copy cannot be used in combination with the margin shift function.



To change the default margin shift setting:

In "Settings (administrator)", select [System Settings] → [Copy Settings] → [Condition Settings] → [Initial Margin Shift Setting].

1

Place the original.

Place the original in the document feeder tray of the automatic document feeder, or on the document glass.

- ▶ [AUTOMATIC DOCUMENT FEEDER \(page 1-84\)](#)
- ▶ [DOCUMENT GLASS \(page 1-86\)](#)

2

Tap the [Others] key, and tap the [Margin Shift] key.



3

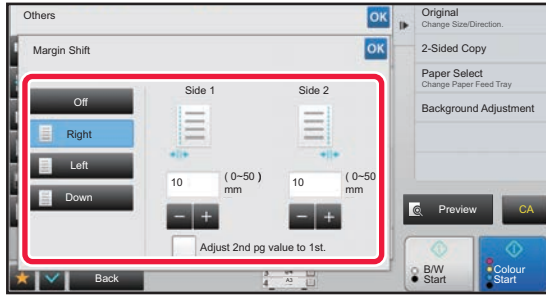

Tap the image shift direction.

4

Sets a margin shift width.

Tap the numeric value display indicating the margin shift area on the front side or reverse side, and enter the area using the numeric keys.

After the settings are completed, tap **OK** and [Back] keys in sequence.



If you set the [Adjust 2nd pg value to 1st.] checkbox to ,  goes out and you can set sides 1 and 2 separately.



- **To cancel the margin shift setting:**

Tap the [Off] key.

- **To cancel all settings:**

Tap the [CA] key.

5

Tap the [Colour Start] or [B/W Start] key to start copying.



ERASING PERIPHERAL SHADOWS FOR COPYING (ERASE)

The erase function is used to erase shadows around the edges of copies that occur when copying thick originals or books.

When a thick book is copied

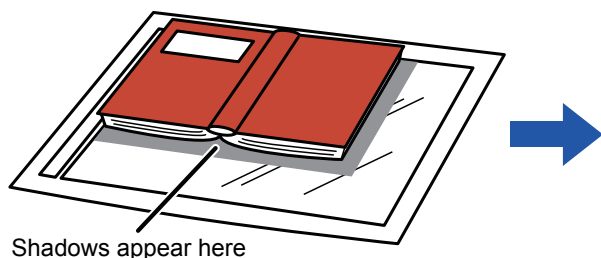

Not using the Erase	Using the Erase
Shadows appear on the copy	Shadows do not appear on the copy

Erase modes

Outer Frame Erase

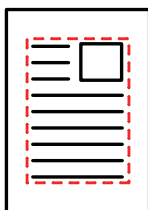

Centre Erase

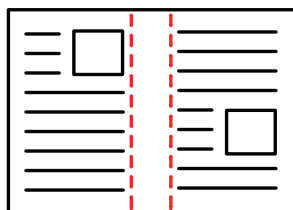

Edge + Centre Erase

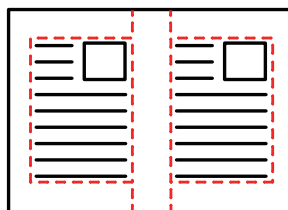

Side Erase



- If a ratio setting is used in combination with an erase setting, the erase width will change according to the selected ratio. If the erase width setting is 20 mm (1") and the image is reduced to 50%, the erase width will be 10 mm (1/2").
- This function erases the parts of the image where shadows tend to form, but does not detect shadows and erase only the shadows.
- When Erase is selected, the orientation of the original is automatically set to portrait.



To change the default erase width setting:

In "Settings (administrator)", select [System Settings] → [Copy Settings] → [Condition Settings] → [Erase Width Adjustment]. The factory default setting is 10 mm (1/2"). The changed setting is also applied to the Setting mode selection of [System Settings] → [Image Send Settings] → [Common Settings] → [Condition Settings] → [Erase Width Adjustment].

1

Place the original.

Place the original in the document feeder tray of the automatic document feeder, or on the document glass.

► [AUTOMATIC DOCUMENT FEEDER \(page 1-84\)](#)

► [DOCUMENT GLASS \(page 1-86\)](#)

2

Tap the [Others] key, and tap the [Erase] key.



3

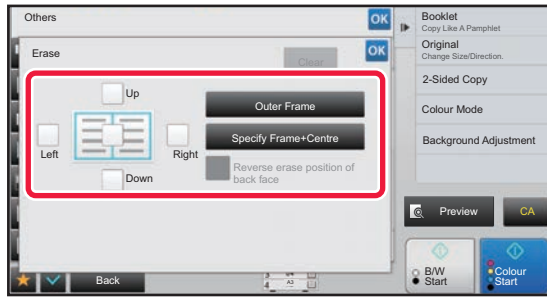

Tap the checkbox of the edge that you wish to erase, and specify the erase position.

Check that the tapped checkbox is set to .

If the [Outer Frame] key is tapped, the [Up], [Down], [Left], and [Right] checkboxes are set to .

If the [Specify Frame+Centre] key is tapped, all the checkboxes are set to .



Specify the erase edge on the reverse side when erasing edges of one to three sides of Up, Down, Left, and Right on the front side to scan a 2-sided original.

- If the [Reverse erase position of back face] checkbox is set to , the edge in the position opposite to the erased edge on the front side will be erased.
- If the [Reverse erase position of back face] checkbox is set to , the edge in the same position as on the front side will be erased.

4

Specify the erase width.

Tap the numeric value display indicating the margin shift area on the front side or reverse side, and enter the area using the numeric keys.

After the settings are completed, tap **OK** and [Back] keys in sequence.



To quickly set the area, first specify a value close to the desired value by the numeric keys, then adjust it with **-** **+**.



- **To cancel the erase setting:**

Tap the [Clear] key.

- **To cancel all settings:**

Tap the [CA] key.

5

Tap the [Colour Start] or [B/W Start] key to start copying.



COPYING ORIGINALS WITH NO EDGE CUT-OFF (FULL BLEED COPY)

This feature lets you copy an entire original to paper larger than the original size with no image cut-off at the edges.

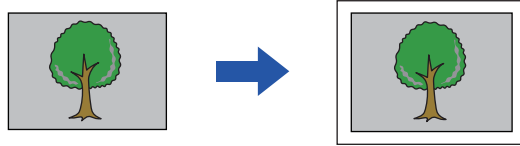

The punch function cannot be used.

1

Tap the [Others] key, and tap the [Full Bleed Copy] key.

"Select larger paper size than output image size of original." is displayed on the page.

Tap [OK].

When you have finished selecting other settings, tap the [Back] key.



To cancel the full bleed copy setting:

Tap the [Full Bleed Copy] key to uncheck it.

2

Place the original.

► [AUTOMATIC DOCUMENT FEEDER \(page 1-84\)](#)

► [DOCUMENT GLASS \(page 1-86\)](#)

3

Select paper larger than the output image

► [SELECTING THE PAPER TRAY FOR COPYING \(page 2-13\)](#)

► [SPECIFYING A TYPE AND SIZE OF PAPER LOADED ON BYPASS TRAY \(page 2-40\)](#)



To cancel all settings:

Tap the [CA] key.

4



Tap the [Colour Start] or [B/W Start] key to start copying.



COPYING IN THE CENTRE OF THE PAPER (CENTRING)

This function centres the copied image on the paper.

This lets you place the image in the centre of the paper when the original size is smaller than the paper size or when the image is reduced.

Not using the centring function	Using the centring function
	



Centring must be specified before scanning the original.



- When the original size or the paper size is displayed as a special size, this function cannot be used.
- This function cannot be used in combination with an enlargement setting. If enlargement of 101% or more is selected, the enlargement is automatically returned to 100%.

1

Tap the [Others] key, and tap the [Centring] key.

A checkmark appears on the icon.

After the settings are completed, tap the [Back] key.



- **To cancel the centring setting:**
Tap the [Centring] key to clear the checkmark.
- **To cancel all settings:**
Tap the [CA] key.

2

Tap the [Colour Start] or [B/W Start] key to start copying.



SPECIFYING A PAPER POSITION (POSITION IMAGE)

This function moves the scanned original to a specified position to make a copy. You can make a copy in any desired position as you can fine adjust the position. We recommend that you specify the top as the starting side of the original.

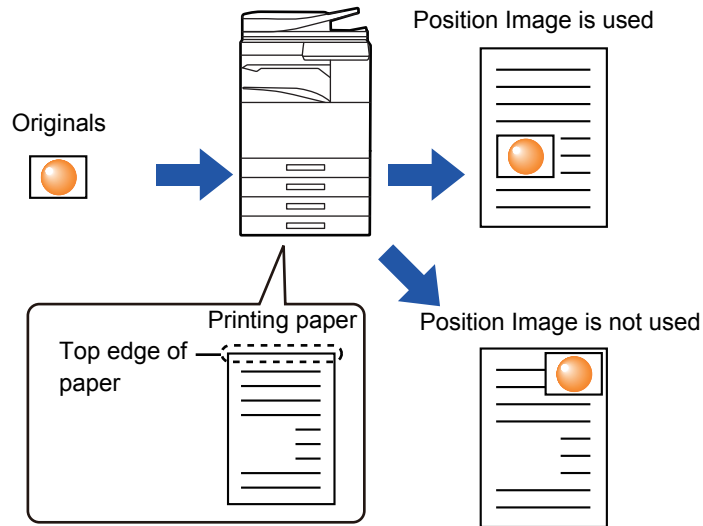
**1**

Copy the original that you want to use for Move Copy.

Copying is performed without using move copy.

2

Measure the movement amount with the top as the starting side of the output copy.

3

Tap the [Others] key, and tap the [Position Image] key.



Tap the [Original] key and specify the orientation of the original to have the orientation be correctly recognized.

► [Specifying the orientation of the original \(page 2-33\)](#)



4

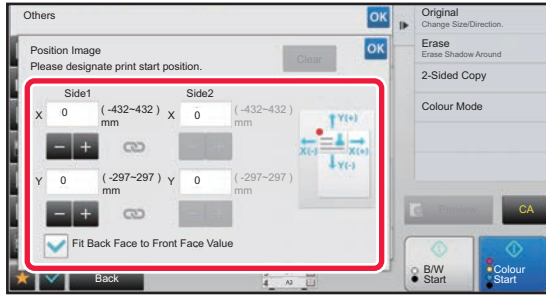

Sets a movement distance.

Tap the area indicating the movement distance on the front or reverse side, and enter the distance using numeric keys. After the settings are completed, tap **OK** and [Back] keys in sequence.



- To quickly set the area, first specify a value close to the desired value by the numeric keys, then adjust it with **-** **+**.
- If you set the [Adjust 2nd pg value to 1st.] checkbox to ,  goes out and you can set sides 1 and 2 separately.
- If you want to copy in the horizontal orientation, specify "Left" as the starting side of the original. Even if you copied in the horizontal orientation, setting the starting side of the original to the top enables measurement of the movement distance in the same way as in the vertical orientation.



To cancel the Position Image setting:

Tap the [Clear] key.

5

Place the original.

Place the original in the document feeder tray of the automatic document feeder, or on the document glass.

- ▶ [AUTOMATIC DOCUMENT FEEDER \(page 1-84\)](#)
- ▶ [DOCUMENT GLASS \(page 1-86\)](#)



To cancel all settings:

Tap the [CA] key.

6

Tap the [Colour Start] or [B/W Start] key to start copying.



SCANNING FUNCTIONS

COLLECTIVELY SCANNING A LARGE NUMBER OF ORIGINALS (JOB BUILD)

This function divides the originals into sets and feeds each set through the automatic document feeder one set at a time when copying a very large number of originals. This saves you the trouble of sorting the copies.

When scanning originals that are separated into sets, scan the set that has the first page first.

The individual copy settings can be configured for each set of originals to be scanned separately.

Up to 100 sets of originals can be scanned for one job.

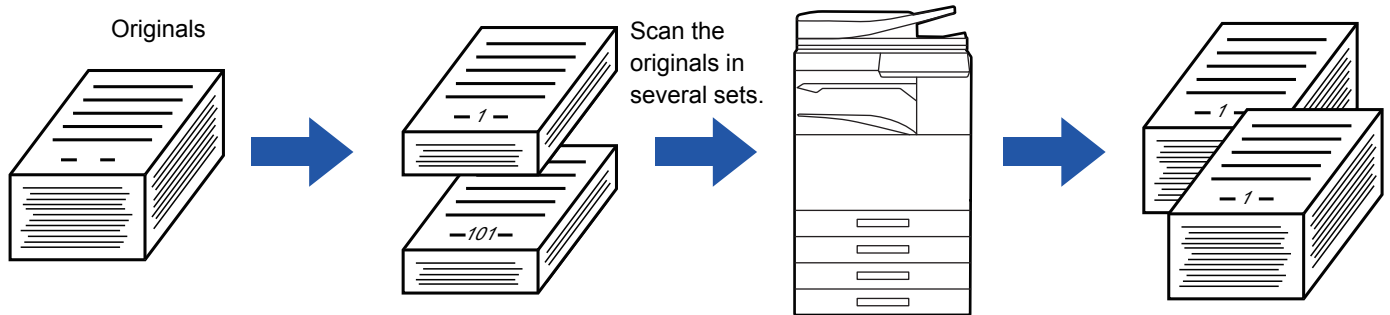

- You must select Job Build mode before scanning the original.
- If you needed to change all original settings, change before scanning the original.
- If the Quick File Folder of document filing mode is full, copying in job build mode will be impeded. Delete unnecessary files from the Quick File Folder.



The Job Build mode cannot be combined with other functions.

- Dual Page Copy
- Book Copy
- Card shot
- Multi-Page Enlargement
- Full Bleed Copy
- Repeat Layout

Copying in job build mode

1

Tap the [Others] key, and tap the [Job Build] key.

A checkmark appears on the icon.

After the settings are completed, tap the [Back] key.



To cancel the job build setting

Tap the [Job Build] key to uncheck it.



2

Change settings as needed.

3

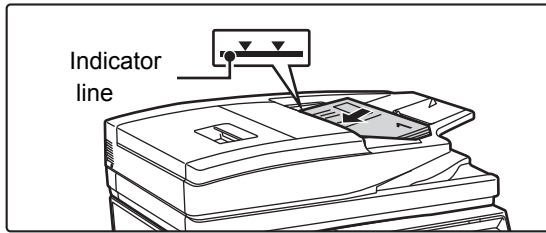

Place the original in the document feeder tray of the automatic document feeder, and tap the [Start] key to scan the first original.

Insert the originals all the way into the document feeder tray. Originals can be stacked up to the indicator line.

► [AUTOMATIC DOCUMENT FEEDER \(page 1-84\)](#)

4

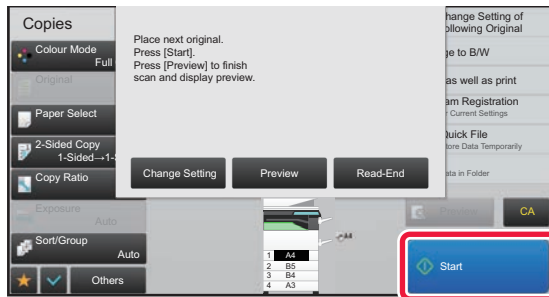

Place the next set of originals and tap the [Start] key.

Repeat this step until all originals have been scanned.



- To change copy settings for each set of originals, tap the [Change Setting] key. For more information, see "[Changing the copy settings for each set of originals \(page 2-94\)](#)".
- If you tap the [Preview] key, you cannot scan additional pages.

5

Repeat until all pages have been scanned and check the preview image in the preview screen.



To cancel all settings:
Tap the [CA] key.

6

Tap the [Read-End] key to start copying.



Changing the copy settings for each set of originals

As necessary, change copy settings for each set of originals.

Perform the steps below before scanning the next set of originals in step 4 of "[Copying in job build mode \(page 2-92\)](#)".



A [Separator Page] setting cannot be changed for the second and later sets.

1

Tap the [Change Setting] key.

2

Change copy settings.

3

Place the next set of originals and tap the [Start] key.

Repeat this step until all originals have been scanned.



SCANNING ORIGINALS OF DIFFERENT SIZES (MIXED SIZE ORIGINAL)

This feature copies originals in different sizes at the same time even when B4 (8-1/2" x 14") size originals are mixed with A3 (11" x 17") size originals.

When scanning the originals, the machine automatically detects the size of each original and uses paper appropriate for that size.

When mixed size original is combined with auto ratio selection, the ratio is adjusted individually for each original according to the selected paper size, enabling printing on a uniform paper size.

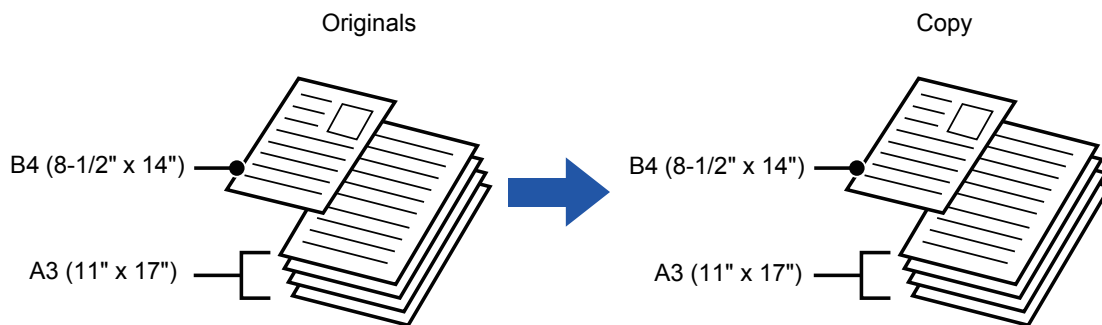

When mixed size original is combined with auto ratio selection

(Auto ratio selection and A3 (11" x 17") are selected)

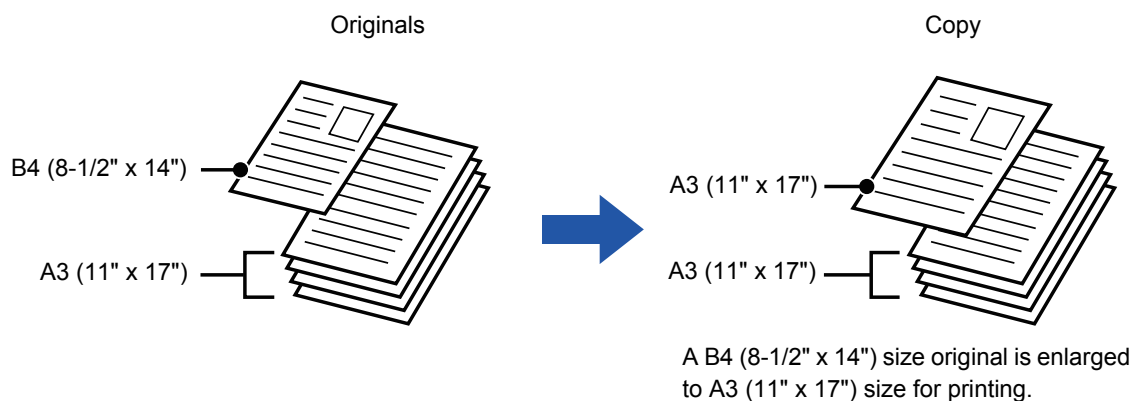

There are two settings for mixed size originals.

Same Width	<p>Use this setting for originals that are different sizes but have sides that are the same length. The originals are inserted in the document feeder tray with the sides that are the same length aligned together on the left.</p> <ul style="list-style-type: none"> • A3 and A4 • B4 and B5 • A4R and A5 • 11" x 17" and 8-1/2" x 11" • 8-1/2" x 14" and 8-1/2" x 11"R • 8-1/2" x 14" and 5-1/2" x 8-1/2" • 8-1/2" x 13" and 8-1/2" x 11"R • 8-1/2" x 13" and 5-1/2" x 8-1/2" • 8-1/2" x 11"R and 5-1/2" x 8-1/2"
Different Width	<p>Use this setting when the originals are different sizes and do not have sides that are the same length. This setting can only be used for the following combinations of sizes:</p> <ul style="list-style-type: none"> • A3 and B4 • A3 and B5 • B4 and A5 • A4 and B5 • B4 and A4R • B4 and A5 • B5 and A4R • B5 and A5 • 11"x17" and 8-1/2"x14" • 11"x17" and 8-1/2"x13" • 11"x17" and 5-1/2"x8-1/2"



Mixed Size Original must be specified before scanning the original.



- When [Different Width] is selected on the MX-2630N/MX-3050V/MX-3060V/MX-3550V/MX-3560V/MX-4050V/MX-4060V/MX-5050V/MX-6050V, automatic two-sided scanning cannot be used.
- When [Different Width] is selected, the staple function cannot be used.
- The mixed size original function cannot be used to copy originals that are the same size but are placed in different orientations (A4 and A4R (8-1/2" x 11" and 8-1/2" x 11"R), etc.).

To set the machine to always scan mixed originals

- In "Settings (administrator)", select [System Settings] → [Common Settings] → [Device Control] → [Original Feeding Mode].
- Output, N-Up, and other functions will have the same settings as the first page.

1

Tap the [Others] key, and tap the [Mixed Size Original] key.

2

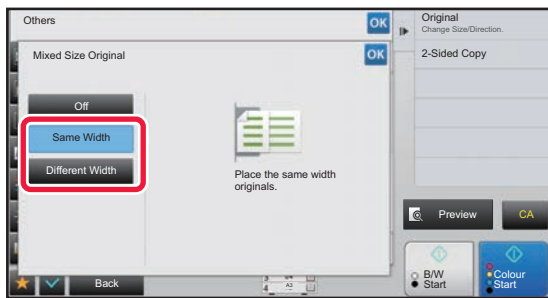

Tap the [Same Width] key or the [Different Width] key as appropriate for the originals.

After the settings are completed, tap **OK** and [Back] keys in sequence.



To cancel the mixed size original setting

Tap the [Off] key.

3

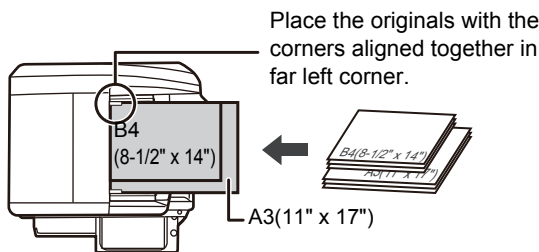

Place the original face up on the document glass.

Place the original as shown on the Mixed Size Original screen.



For mixed size originals, set "Original" to "Auto".



4

Tap the [Colour Start] or [B/W Start] key to start copying.



MX-2630N/MX-3050V/MX-3060V/MX-3550V/MX-3560V/MX-4050V/MX-4060V/MX-5050V/MX-6050V

If the printed image is skewed when using the mixed size original function for originals of mixed width, open the document feeder cover, change the switch position, and then scan the originals. Switch position A is used for normal scanning, and switch position B is used for mixed size original scanning. When you have finished using the mixed size original function, be sure to return the switch to position A.

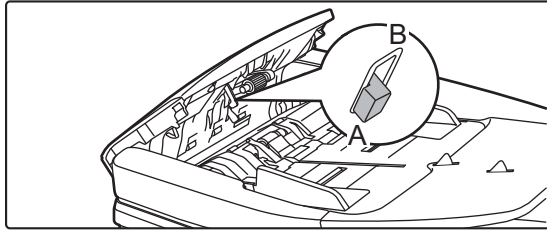



SCANNING THIN ORIGINALS (SLOW SCAN MODE)

When you wish to scan thin originals using the automatic document feeder, you can use this function, which helps prevent thin originals from misfeeding.

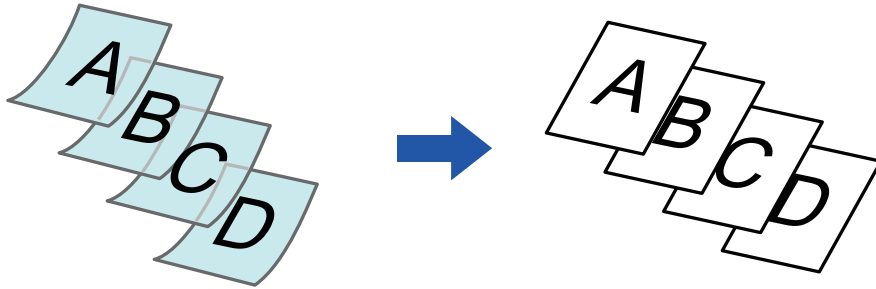

Slow Scan Mode must be specified before scanning the original.



The "2-Sided→2-Sided" and "2-Sided→1-Sided" modes of automatic 2-sided copying cannot be used.



To always scan the original in the slow scan mode:

In "Settings (administrator)", select [System Settings] → [Common Settings] → [Device Control] → [Original Feeding Mode].

1

Tap the [Others] key, and tap the [Slow Scan Mode] key.

A checkmark appears on the icon.

After the settings are completed, tap the [Back] key.



To cancel slow scan mode:

Tap the [Slow Scan Mode] key to clear the checkmark.

2

Place the original in the document feeder tray of the automatic document feeder.

► [AUTOMATIC DOCUMENT FEEDER \(page 1-84\)](#)



If the originals are inserted with too much force, they may crumple and misfeed.

3

Tap the [Colour Start] or [B/W Start] key to start copying.



ADJUSTING RESOLUTION WHEN SCANNING (RESOLUTION)

This function adjusts the resolution when scanning the original, enabling the high-quality output or speed-priority output according to the application.



- Resolution must be specified before scanning the original.
- The resolution setting is applied when making a full-size black & white copy.

1

Tap the [Others] key, and tap the [Scan Resolution] key.

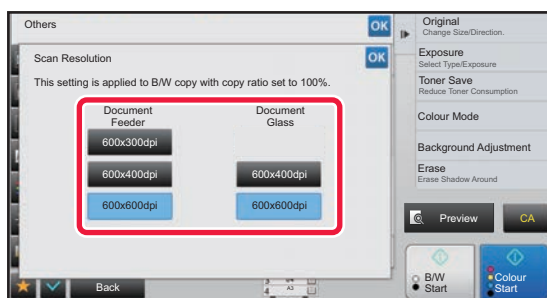
2

Select the resolution.

The resolution can be set to both the document feeder and document glass.

After the settings are completed, tap **OK** and [Back] keys in sequence.

3

Place the original.

Place the original in the document feeder tray of the automatic document feeder, or on the document glass.

- ▶ [AUTOMATIC DOCUMENT FEEDER \(page 1-84\)](#)
- ▶ [DOCUMENT GLASS \(page 1-86\)](#)

4

Tap the [B/W Start] key to start copying.



TEXT AND IMAGE ADDITION FUNCTIONS

PRINTING DATES, PAGE NUMBERS, AND WATERMARKS (STAMP)

This function prints information such as the "Date" or "Stamp", which is not shown on the original, on copies. You can print the following six types of information.

- Date
- Page No.
- Stamp
- Copies
- Text
- Watermark

For the stamp or watermark, you can print text such as "CONFIDENTIAL" or "PRIORITY". You can print pre-set text or any characters as the text.

Each of the items above can be printed on the header or footer of each sheet.

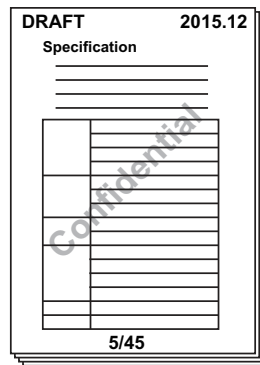

- If the selected stamp content of one position overlaps the stamp content of another position, priority will be given in the following order: watermark, right side, left side, centre. Content that is hidden due to overlapping will not be printed.
- Text will be printed at the preset size regardless of the copy ratio or paper size setting.
- Text will be printed at the preset exposure regardless of the exposure setting.
- Depending on the size of the paper, some printed content may be cut off or shifted out of position.

When [Stamp] is combined with other functions:

Combined function name	Print operation
Margin Shift	Together with the image, the stamp content is shifted the amount of the margin width.
Tab Copy Centring	Unlike a copy image that moves, the image will be printed in the position set in the stamp.
Dual Page Copy Book Divide Card Shot	Stamp items are printed for each copy sheet.
N-Up	Stamp items are printed for each original page.
Booklet Book Copy	Stamp items are printed for each page when compiling.
Covers/Inserts	Use the stamp settings to select whether or not the item is printed on inserted covers and inserts.



1

Place the original.

Place the original in the document feeder tray of the automatic document feeder, or on the document glass.

- ▶ [AUTOMATIC DOCUMENT FEEDER \(page 1-84\)](#)
- ▶ [DOCUMENT GLASS \(page 1-86\)](#)

2

Tap the [Others] key, and tap the [Stamp] key.

3

Tap a tab to be printed, and tap the format.

The format of the [Text] tab can be entered using pre-set text or soft keyboard.

- ▶ [Setting using the \[Text\] tab \(page 2-102\)](#)



When you tap the  tab, the display tab is switched.

4

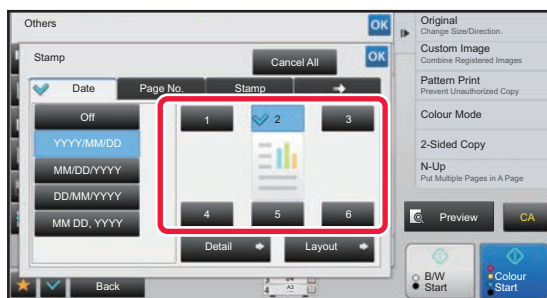

Tap a key of the desired print position.

Tap any of [1] to [6] keys.



- Tapping the [Detail] key allows you to configure setting for each tab such as a print colour.
- Tapping the [Layout] key allows you to check the printing position or detailed settings.



- To cancel the text settings:
Tap the [Cancel All] key.
- To cancel all settings:
Tap the [CA] key.

5

Tap the [Colour Start] or [B/W Start] key to start copying.



- If you select colour printing, tap the [Colour Start] key. Tapping the [B/W Start] key will print the stamp items in black and white even if colour printing is specified.
- If colour printing is specified for the original in black and white, it is counted as a full colour copy.



Setting using the [Text] tab

Tap the [Direct Entry] key in the [Text] tab to display the soft keyboard.
Use the soft keyboard to enter any characters.



Selecting the format from pre-set text

Tapping the [Pre-Set Text] key allows you to select the required one of the registered formats for printing.
Tapping the [Store/Delete] key allows you to edit, delete, or store pre-set text.

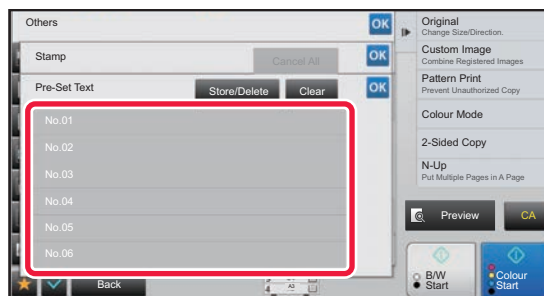



ADDING A REGISTERED IMAGE TO AN ORIGINAL (CUSTOM IMAGE)

This function adds an image registered in the machine to an original to make a copy. Following are two types of custom images.

- Custom stamp (Full-colour stamp image)

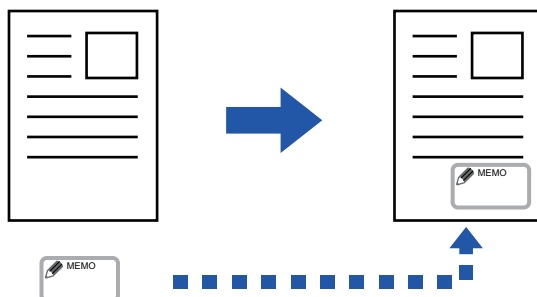

- Custom watermark (Stamp image with grey-scale watermark)

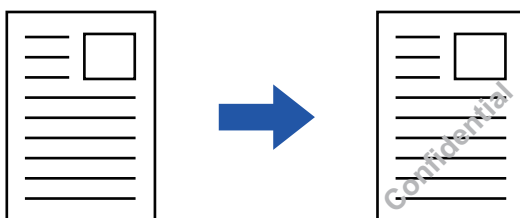

The combination with other functions is described in the table below.

Combined function	Custom image operations
Margin Shift	Shifts in the same way as for an original image.
Erase	Makes a stamp copy as normal.
Dual Page Copy	Makes a stamp copy by sheet.
Booklet	Makes a stamp copy as normal.
Job Build	Makes a stamp copy as normal.
Tandem Copy	Based on the tandem copy.
Covers/Inserts	Based on the custom image setting.
Separator Page	Printing does not take place on separator pages.
Transparency Inserts	Makes a stamp copy as normal.
N-Up	Makes a stamp copy by sheet.
Book Copy	Makes a stamp copy as normal.
Tab Copy	Makes a stamp copy as normal regardless of image shift setting.
Card Shot	Makes a stamp copy by sheet.
Mirror Image	Makes a stamp copy as normal without mirror image reverse.
B/W Reverse	Prints an image as normal without B/W reverse. However, the following condition is set when printed on a dark background. Custom stamp: Printed in white Custom watermark: Printed without being whitened



Combined function	Custom image operations
Full Bleed Copy	Makes a stamp copy as normal.
Centring	Makes a stamp copy as normal without centring.
Colour Adjustments	Makes a stamp copy using the registered data.
Stamp	Makes a stamp copy on the Stamp menu.
Photo Repeat	Cannot be combined.
Multi-Page Enlargement	Cannot be combined.
Hidden Pattern Print	Makes a stamp copy under a pattern print.
Tracking Information Print	Makes a stamp copy under a tracking information print.
Repeat Layout	Cannot be combined.
Position Image	Prints an image at the original position regardless of the Position Image setting.
Book Divide	Makes a stamp copy by sheet.



- An image must be registered in advance from the printer driver to the machine.
 - ▶ [REGISTERING A CUSTOM IMAGE \(page 3-51\)](#)
- A custom stamp image is copied by sheet, not by original. If N-Up is enabled, user stamps are copied for each set of pages.
- A custom stamp image is copied with the registered size. The size remains unchanged even when the copy ratio is enlarged or reduced.
- A different custom image cannot be specified for each page.
- When you tap the [B/W Start] key, a monochrome copy is made even if you have selected a custom stamp.
- If an image runs off of the specified paper depending on the registered size or position, the excess will not be copied.
- Custom Image can be combined with Tandem Copy.
Stamp copy is performed when a custom image with the same file name is registered in both the master and client machines.
If it is not registered, a copy will be made without a custom image.

1**Place the original.**

Place the original in the document feeder tray of the automatic document feeder, or on the document glass.

- ▶ [AUTOMATIC DOCUMENT FEEDER \(page 1-84\)](#)
- ▶ [DOCUMENT GLASS \(page 1-86\)](#)

2**Tap the [Others] key, and tap the [Custom Image] key.****3****Tap the [Custom Stamp] or [Custom Watermark] key.****4****Tap the [Image] key to select an image.**

Select the required thumbnail image(s) from the available selection.



5

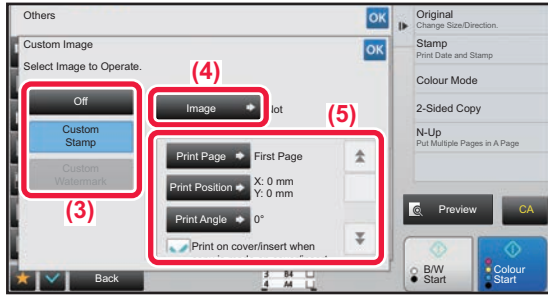

Set [Print Page] or [Print Position].

After the settings are completed, tap **OK** and [Back] keys in sequence.



- **To cancel the custom image setting:**
Tap the [Off] key.
- **To cancel all settings:**
Tap the [CA] key.

6

Tap the [Colour Start] or [B/W Start] key to start copying.

For settings related to custom stamp and custom water mark, see the following table.

For custom stamp

Print Page	Specify a page(s) for stamp copy. First Page or All Pages
Print Position	Specify a position for stamp copy.
Print Angle	Specify the corner of the image. 0 degrees, -90 degrees, 90 degrees, or 180 degrees

For custom watermark

Print Colour	Specify the image watermark colour. Black, red, green, blue, cyan, magenta or yellow.
Print Pattern	Specify the image watermark print pattern. Transparent: Makes an original image transparent for stamp copy. Overlap: Hides a watermark added to an original image for stamp copy.
Exposure	Select the exposure of a watermark from nine levels.
Print Page	Specify a page(s) for stamp copy. First Page or All Pages
Print Position	Specify a position for stamp copy.
Print Angle	Specify the corner of the image. 0 degrees, -90 degrees, 90 degrees, or 180 degrees



INSERTING COVERS IN COPIES (COVERS/INSERTS)

This function inserts a different type of paper into the pages corresponding to the front and back covers of a copy job. It is helpful when you want to change cover paper to make resources look better. Configure insertion sheet settings if needed.



- To insert insertion sheets, see "[INSERTING INSERTION SHEETS IN COPIES \(COVERS/INSERTS\) \(page 2-114\)](#)".
- For N-Up, the layout is based on the first page and excludes covers.

Copying on a front cover and inserting together with a back cover

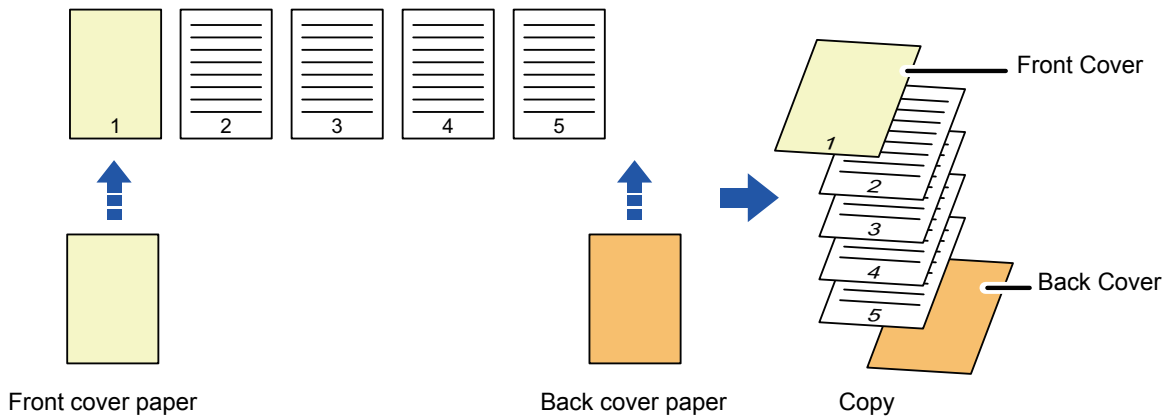

Cover inserting examples

The following shows the copy results when front and back covers are inserted into six 1-sided original pages or three 2-sided original pages in the four copy modes below.

1-sided copying of 1-sided originals

Setting conditions for each cover		Resulting copies
Front Cover	Back Cover	
Not copied	Not copied	<p>Inserts cover sheets at the beginning and end of copies.</p>
1-sided copy	Not copied	<p>Makes a 1-sided copy on the first original page for front cover, and inserts a back cover at the end of copies.</p>
2-sided copy	Not copied	<p>Makes a 2-sided copy on the first and second original pages for front cover, and inserts a back cover at the end of copies.</p>



Setting conditions for each cover		Resulting copies
Front Cover	Back Cover	
Not copied	1-sided copy	<p>Inserts a front cover at the beginning of copies, and makes a 1-sided copy on the sixth original page for back cover.</p>
Not copied	2-sided copy	<p>Inserts a front cover at the beginning of copies, and makes a 2-sided copy on the fifth and sixth original pages for back cover.</p>
1-sided copy	1-sided copy	<p>Makes a 1-sided copy on the first original page for front cover, and also makes a 1-sided copy on the sixth original page for back cover.</p>
1-sided copy	2-sided copy	<p>Makes a 1-sided copy on the first original page for front cover, and also makes a 2-sided copy on the fifth and sixth original pages for back cover.</p>
2-sided copy	1-sided copy	<p>Makes a 2-sided copy on the first and second original pages for front cover, and also makes a 1-sided copy on the sixth original page for back cover.</p>
2-sided copy	2-sided copy	<p>Makes a 2-sided copy on the first and second original pages for front cover, and also makes a 2-sided copy on the fifth and sixth original pages for back cover.</p>

2-sided copying of 1-sided originals

Setting conditions for each cover		Resulting copies
Front Cover	Back Cover	
Not copied	Not copied	<p>Inserts cover sheets at the beginning and end of copies.</p>



Setting conditions for each cover		Resulting copies
Front Cover	Back Cover	
1-sided copy	Not copied	<p>Makes a 1-sided copy on the first original page for front cover, and also makes a 1-sided copy on the sixth original page. Inserts cover sheets at the end of copies.</p>
2-sided copy	Not copied	<p>Makes a 2-sided copy on the first and second original pages for front cover, and inserts a back cover at the end of copies.</p>
Not copied	1-sided copy	<p>Inserts a front cover at the beginning of copies, and makes a 1-sided copy on the sixth original page for back cover. A 1-sided copy is made on the fifth original page.</p>
Not copied	2-sided copy	<p>Inserts a front cover at the beginning of copies, and makes a 2-sided copy on the fifth and sixth original pages for back cover.</p>
1-sided copy	1-sided copy	<p>Makes a 1-sided copy on the first original page for front cover, and also makes a 1-sided copy on the sixth original page for back cover.</p>
1-sided copy	2-sided copy	<p>Makes a 1-sided copy on the first original page for front cover, and also makes a 2-sided copy on the fifth and sixth original pages for back cover.</p>
2-sided copy	1-sided copy	<p>Makes a 2-sided copy on the first and second original pages for front cover, and also makes a 1-sided copy on the sixth original page for back cover. A 1-sided copy is made on the fifth original page.</p>

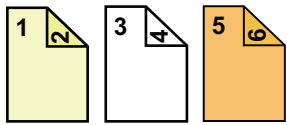

Setting conditions for each cover		Resulting copies
Front Cover	Back Cover	
2-sided copy	2-sided copy	 <p>Makes a 2-sided copy on the first and second original pages for front cover, and also makes a 2-sided copy on the fifth and sixth original pages for back cover.</p>

1-sided copying of 2-sided originals

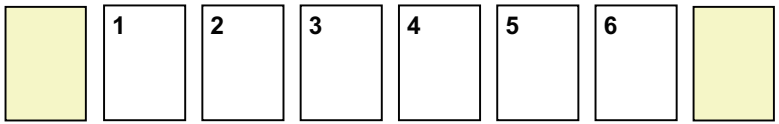
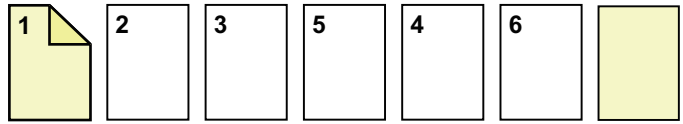
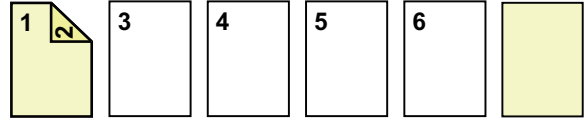
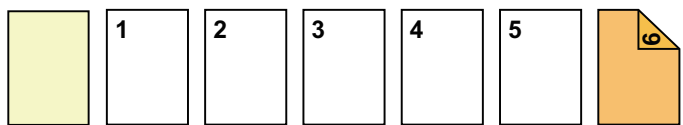
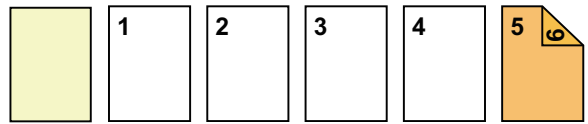
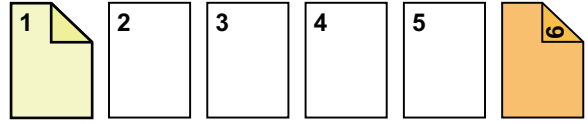
Setting conditions for each cover		Resulting copies
Front Cover	Back Cover	
Not copied	Not copied	 <p>Inserts cover sheets at the beginning and end of copies.</p>
1-sided copy	Not copied	 <p>Makes a 1-sided copy on the first original page for front cover, and inserts a back cover at the end of copies.</p>
2-sided copy	Not copied	 <p>Makes a 2-sided copy on the first and second original pages for front cover, and inserts a back cover at the end of copies.</p>
Not copied	1-sided copy	 <p>Inserts a front cover at the beginning of copies, and makes a 1-sided copy on the sixth original page for back cover.</p>
Not copied	2-sided copy	 <p>Inserts a front cover at the beginning of copies, and makes a 2-sided copy on the fifth and sixth original pages for back cover.</p>
1-sided copy	1-sided copy	 <p>Makes a 1-sided copy on the first original page for front cover, and also makes a 1-sided copy on the sixth original page for back cover.</p>

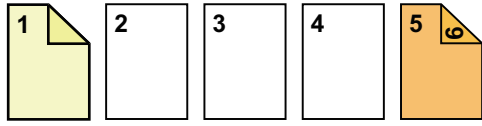
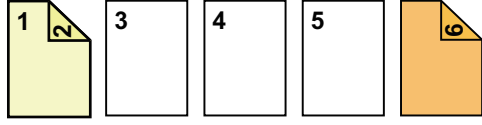
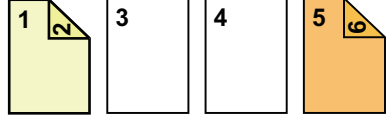

Setting conditions for each cover		Resulting copies
Front Cover	Back Cover	
1-sided copy	2-sided copy	 <p>Makes a 1-sided copy on the first original page for front cover, and also makes a 2-sided copy on the sixth original page for back cover.</p>
2-sided copy	1-sided copy	 <p>Makes a 2-sided copy on the first and second original pages for front cover, and also makes a 1-sided copy on the sixth original page for back cover.</p>
2-sided copy	2-sided copy	 <p>Makes a 2-sided copy on the first and second original pages for front cover, and also makes a 2-sided copy on the fifth and sixth original pages for back cover.</p>

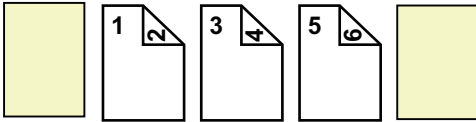
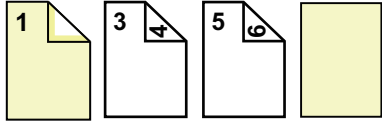
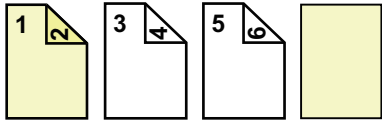
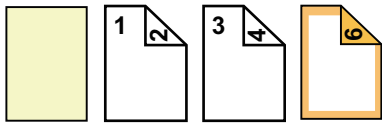
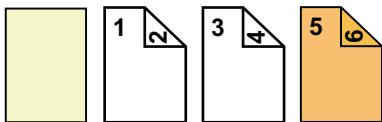
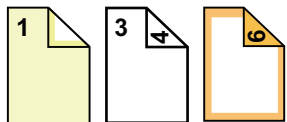
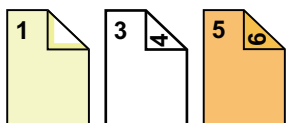

2-sided copying of 2-sided originals

Setting conditions for each cover		Resulting copies
Front Cover	Back Cover	
Not copied	Not copied	 <p>Inserts cover sheets at the beginning and end of copies.</p>
1-sided copy	Not copied	 <p>Makes a 1-sided copy on the first original page for front cover, and inserts a back cover at the end of copies. * The second original page is not copied.</p>
2-sided copy	Not copied	 <p>Makes a 2-sided copy on the first and second original pages for front cover, and inserts a back cover at the end of copies.</p>
Not copied	1-sided copy	 <p>Inserts a front cover at the beginning of copies, and makes a 1-sided copy on the sixth original page for back cover. * The fifth original page is not copied.</p>
Not copied	2-sided copy	 <p>Inserts a front cover at the beginning of copies, and makes a 2-sided copy on the fifth and sixth original pages for back cover.</p>
1-sided copy	1-sided copy	 <p>Makes a 1-sided copy on the first original page for front cover, and also makes a 1-sided copy on the sixth original page for back cover. The second and the fifth original pages are not copied.</p>
1-sided copy	2-sided copy	 <p>Makes a 1-sided copy on the first original page for front cover, and also makes a 2-sided copy on the fifth and sixth original pages for back cover. * The second original page is not copied.</p>



Setting conditions for each cover		Resulting copies
Front Cover	Back Cover	
2-sided copy	1-sided copy	<p>Makes a 2-sided copy on the first and second original pages for front cover, and also makes a 1-sided copy on the sixth original page for back cover. * The fifth original page is not copied.</p>
2-sided copy	2-sided copy	<p>Makes a 2-sided copy on the first and second original pages for front cover, and also makes a 2-sided copy on the fifth and sixth original pages for back cover.</p>



- Before using the covers/inserts function, load insertion sheets in the tray.
- When selecting the covers/inserts function, place the originals in the document feeder tray, select 1-sided or 2-sided copying, and select the number of copies and any other desired copy settings. When these settings have been completed, perform the procedure to select covers/inserts.
- One sheet can be inserted for each of front and back covers.



- When performing 2-sided copying of 2-sided originals, an insertion sheet cannot be inserted between the front and reverse sides of an original.
- This function cannot be used in combination with the saddle stitch function.
- This setting is not available when the "Covers/Inserts" is disabled in "Settings".

1

Place the original in the document feeder tray of the automatic document feeder.

► [AUTOMATIC DOCUMENT FEEDER \(page 1-84\)](#)

2

Tap the [Others] key, and then tap the [Covers/Inserts] key.

3

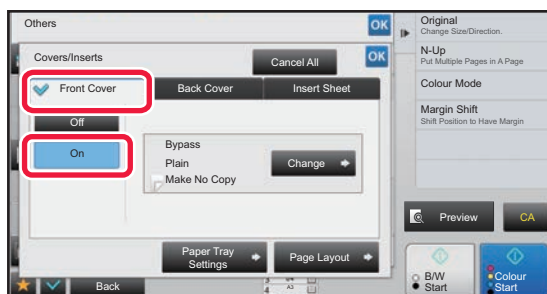

Tap the [Front Cover] key, and then tap the [On] key.

When inserting a back cover, tap the [Back Cover] tab, and then tap the [On] key.



4

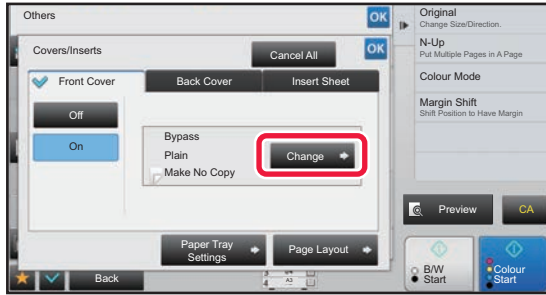

Tap the [Change] key.

5

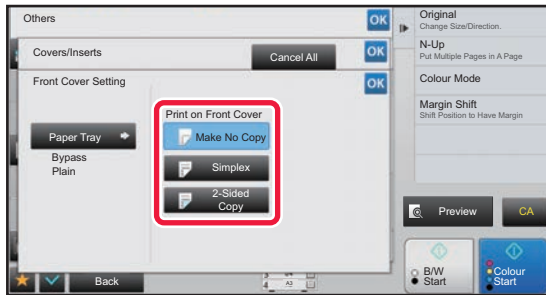

Configure copy setting of a front cover sheet.

When only inserting a cover, tap the [Make No Copy] key. If you selected the [2-Sided Copy] key, tap the [Book] or [Tablet] key for the front cover binding. After the settings are completed, tap **OK** and [Back] keys in sequence.



To change the cover input tray:

Tap the [Paper Tray Settings] key to display the input tray setting screen. On the input tray setting screen, tap the [Paper Tray] key of [Front Cover] or [Back Cover].
For more information, see "[SELECTING THE PAPER TRAY FOR COPYING \(page 2-13\)](#)".



- If the cover will be copied on, label sheets, transparency film, and tab paper cannot be used. If not copied on, tab paper can be inserted.
- **To cancel cover sheet insertion:**
Tap the [Off] key.
- **To cancel the front cover, back cover, and insertion sheet settings at the same time:**
Tap the [Cancel All] key.
- **To cancel all settings:**
Tap the [CA] key.

6

Tap the [Colour Start] or [B/W Start] key to start copying.



INSERTING INSERTION SHEETS IN COPIES (COVERS/INSERTS)

This function inserts a sheet of paper into a specific page as an insertion sheet. There are two types of insertion sheets. Insertion positions can be specified. Insert covers if needed.



When inserting covers, see "[INSERTING COVERS IN COPIES \(COVERS/INSERTS\) \(page 2-106\)](#)".

Example: Insert A after page 3 and insert B after page 5.

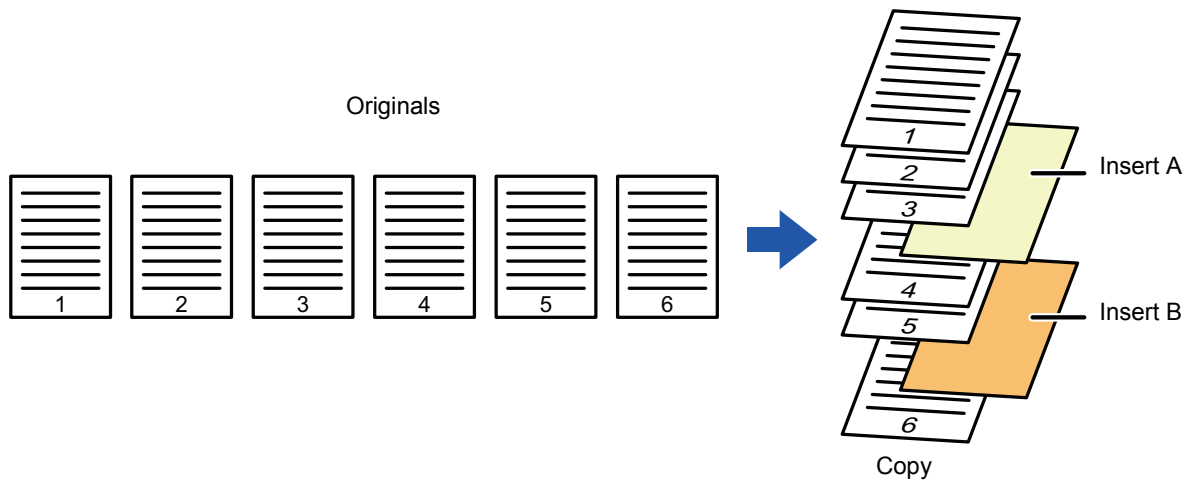

Sheet inserting examples

The following examples show the copy results when insertion sheets are inserted into six 1-sided originals or three 2-sided originals using two copy modes.

1-sided original copying

Insertion sheet setting conditions	Resulting copies	
	Insert an insertion sheet in 1-sided copy mode.	Insert an insertion sheet in 2-sided copy mode.
Not copied	<p>Inserts an insertion sheet between the second and third pages of copies.</p>	
1-sided copy	<p>Makes a 1-sided copy of the third original page on an insertion sheet.</p>	

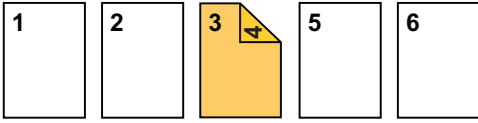
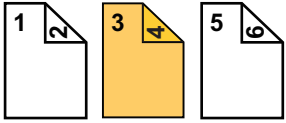

Insertion sheet setting conditions	Resulting copies	
	Insert an insertion sheet in 1-sided copy mode.	Insert an insertion sheet in 2-sided copy mode.
2-sided copy	 <p>Makes a 2-sided copy of the third and fourth original pages on an insertion sheet.</p>	

2-sided original copying

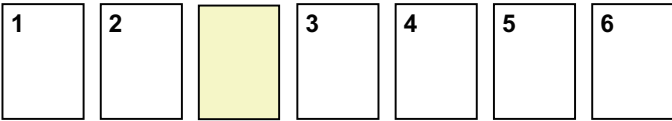
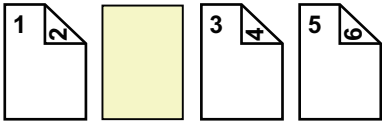
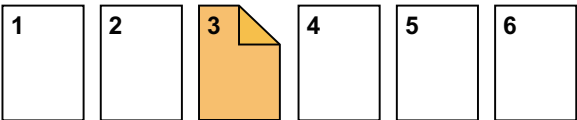
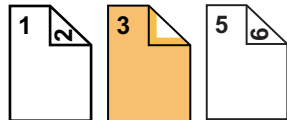
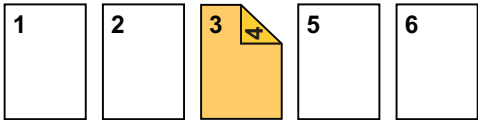
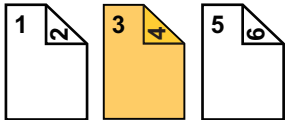
Insertion sheet setting conditions	Resulting copies	
	Insert an insertion sheet in 1-sided copy mode.	Insert an insertion sheet in 2-sided copy mode.
Not copied	 <p>Inserts an insertion sheet between the second and third pages of copies.</p>	
1-sided copy	 <p>Makes a 1-sided copy of the third original page on an insertion sheet.</p>	 <p>* The fourth original page is not copied.</p>
2-sided copy	 <p>Makes a 2-sided copy of the third and fourth original pages on an insertion sheet.</p>	



- Before using the covers/inserts function, load insertion sheets in the tray.
- When selecting the covers/inserts function, place the originals in the document feeder tray, select 1-sided or 2-sided copying, and select the number of copies and any other desired copy settings. When these settings have been completed, perform the procedure to select covers/inserts.
- The insertion sheet size must be the same as the copy size.
- Up to 100 insertion sheets can be inserted.



- The document glass is not available for this function.
- Take care that two insertion sheets cannot be inserted into the same page.
- When performing 2-sided copying of 2-sided originals, an insertion sheet cannot be inserted between the front and reverse sides of an original.
- This function cannot be used in combination with the saddle stitch function.
- This setting is not available when the covers/inserts function is disabled in "Settings (administrator)".



1

Place the original in the document feeder tray of the automatic document feeder.

► [AUTOMATIC DOCUMENT FEEDER \(page 1-84\)](#)

2

Tap the [Others] key, and then tap the [Covers/Inserts] key.

3

Tap the [Insertion Sheet] tab.

4

Tap the [Insertion Type A] key, and tap the insert page display key.

The Insertion Type B to Type H settings are the same as the Insertion Type A settings.

5

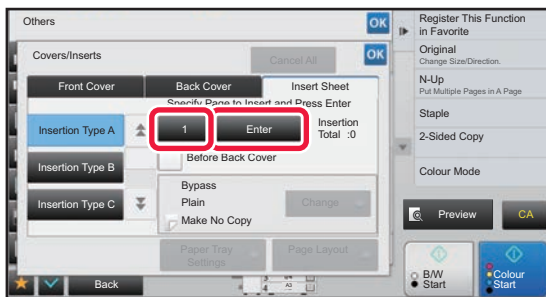

Enter the number of the page you want to insert a sheet into using numeric keys, and then tap the [Enter] key.

The total number of insertion sheets is displayed at the side of [Enter] key. Repeat these steps for the number of insertion sheets.

After the settings are completed, tap **OK** and [Back] keys in sequence.



• If you have entered an incorrect insert page number:

Tap the [Page Layout] key and change the page.

► [CHECKING, EDITING, AND DELETING THE PAGE LAYOUT OF COVERS AND INSERTION SHEETS \(PAGE LAYOUT\) \(page 2-118\)](#)

• To cancel insertion sheets:

Tap the [Cancel All] key.

6

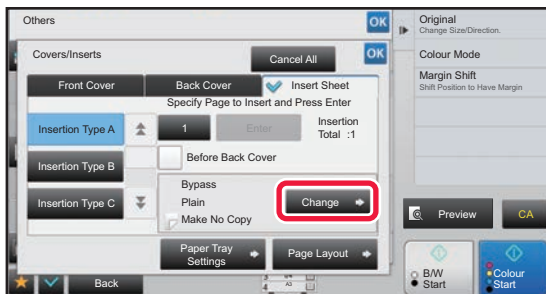

Tap the [Change] key.



7

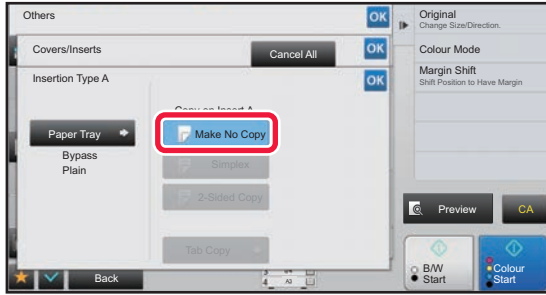

When only inserting insertion sheet A, tap the [Make No Copy] key.

When making a copy on insertion sheet A, tap the [Simplex] or [2-Sided Copy] key.

If you selected [2-Sided Copy], tap the [Book] key or [Tablet] key for the insert sheet binding.

After the settings are completed, tap **OK**.



To change an insertion sheet:

Tap the [Paper Tray] key, and select the tray with insertion sheets loaded.

To copy on tab paper, tap the [Tab Copy] key.

► [COPYING CAPTIONS ONTO TAB PAPER \(TAB COPY\) \(page 2-121\)](#)



When copying on both sides of an insertion sheet, you cannot use label sheets, transparency films, or tab paper for insertion. If not copied on, tab paper can be inserted.

To cancel all settings:

Tap the [CA] key.

8

Tap the [Colour Start] or [B/W Start] key to start copying.



CHECKING, EDITING, AND DELETING THE PAGE LAYOUT OF COVERS AND INSERTION SHEETS (PAGE LAYOUT)



The editing contents are different between the registered covers and insertion sheets as shown below.

- For the "Cover Sheet", you can change settings such as the paper type, copy/do not copy, 1-Sided, and 2-Sided.
- For "Insert Sheet", you can change only the page number you want to insert an insert sheet into.

1

Tap the [Others] key, and then tap the [Covers/Inserts] key.

2

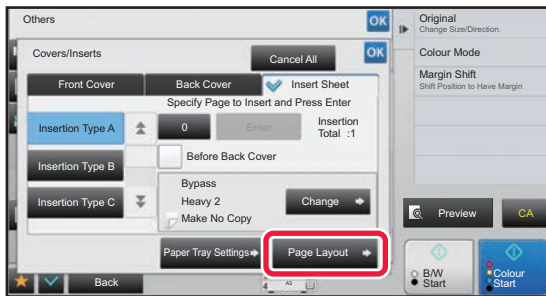

Tap the [Page Layout] key.



If the settings for the covers or insertion sheets are not configured, the [Page Layout] key is disabled.

3

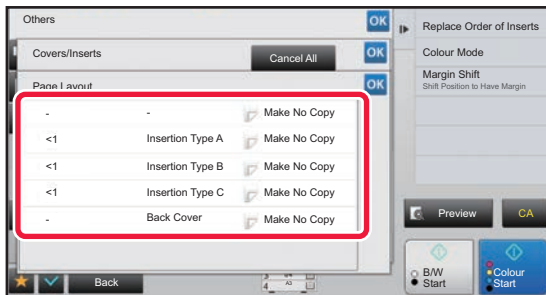

Check the page layout.

To exit this job after checking the page layout, tap the **OK** key.

To edit or delete, tap the required key. When deleting, tap the [Delete] key. When editing, tap the [Amend] key.

When setting consecutive insertion of different types of inserts at the same page, you can tap [Replace Order of Inserts] on the action panel to change the order.

4

Change cover or insertion sheet settings.

For the cover, you can change the copy mode.

You can change the page number you want to insert an insert sheet into.

After the settings are completed, tap the **OK** key multiple times to return to the [Others] screen. Then, tap the [Back] key.



INSERTING INSERTION SHEETS IN BETWEEN TRANSPARENCY FILMS (TRANSPARENCY INSERTS)

When copying on transparency film, the sheets may stick together due to static electricity.

The transparency inserts function can be used to automatically insert a sheet of paper between each sheet of transparency film, making the sheets easy to handle.

It is also possible to copy on insertion sheets.

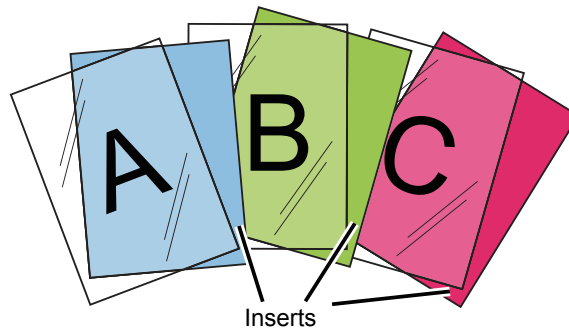

When performing 2-sided copying, only "2-Sided→1-Sided" mode can be used.

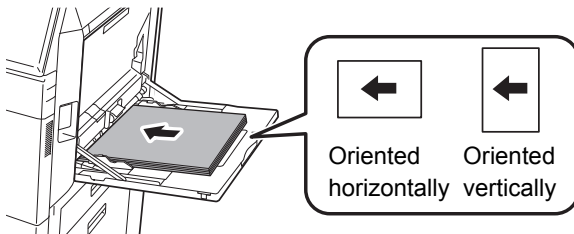

- The number of copies cannot be selected in this mode.
- Transparency film must be loaded in the bypass tray.

1

Place the transparency film face down in the bypass tray, and load transparency film sheets.

After loading the transparency film, configure the bypass tray settings.

- ▶ [MAKING COPIES USING THE BYPASS TRAY \(page 2-39\)](#)

2

Place the original.

Place the original in the document feeder tray of the automatic document feeder, or on the document glass.

- ▶ [AUTOMATIC DOCUMENT FEEDER \(page 1-84\)](#)
- ▶ [DOCUMENT GLASS \(page 1-86\)](#)

3

Tap the [Others] key, and then tap the [Transparency Inserts] key.



4



Tap the [On] key.

When making a copy on insertion sheets, tap the [Also Make Copy on Inserts] checkbox to set to . After the settings are completed, tap and [Back] keys in sequence.



- **To cancel the transparency inserts setting:**
Tap the [Off] key.
- **To cancel all settings:**
Tap the [CA] key.

5

Tap the [Colour Start] or [B/W Start] key to start copying.



FUNCTIONS FOR SPECIFIC USES

COPYING CAPTIONS ONTO TAB PAPER (TAB COPY)

Load a tab sheet in the bypass tray, and make a copy on a tab.
Prepare appropriate originals for tab captions.

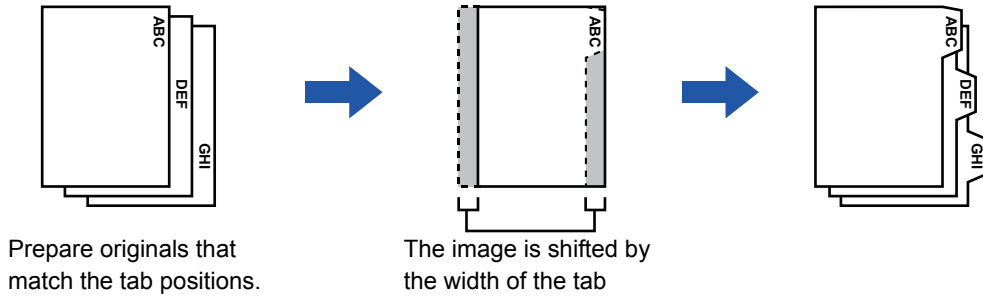

Relation between the originals and the tab paper

Tab copying with a left binding

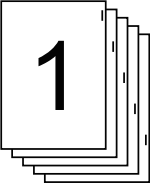
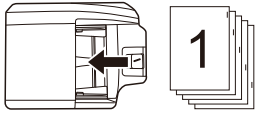
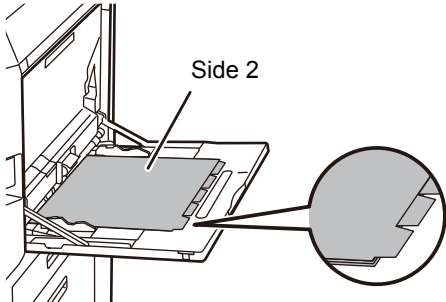
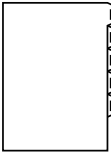
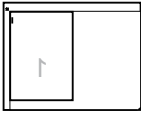
Originals	Placing the originals	Loading tab paper
<p>Originals</p> 	<p>Document feeder tray</p>  <p>Insert the originals so that the side with no tab text enters first.</p>	 <p>Side 2</p> <p>Load the tab paper so that the tab on the first sheet is toward you.</p>
<p>Final image</p> 	<p>Document glass</p>  <p>Place so that the side with the tab text is on the left.</p>	

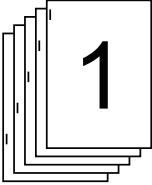
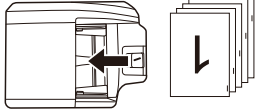
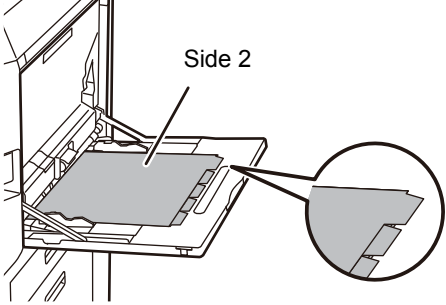
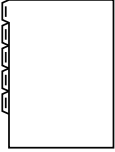
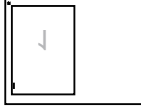

Tab copying with a right binding

Originals	Placing the originals	Loading tab paper
<p>Originals</p> 	<p>Document feeder tray</p>  <p>Insert the originals so that the side with no tab text enters first.</p>	 <p>Load the tab paper so that the tab on the first sheet is away from you.</p>
<p>Final image</p> 	<p>Document glass</p>  <p>Place so that the side with the tab text is on the left.</p>	



Tab Copy must be specified before scanning the original.



To change the default image shift width for tab copying:

In "Settings (administrator)", select [System Settings] → [Copy Settings] → [Condition Settings] → [Initial Tab Copy Setting]. The factory default setting is 10 mm (1/2").

1

Tap the [Others] key, and tap the [Tab Copy] key.

2

Tap the [On] key.



3

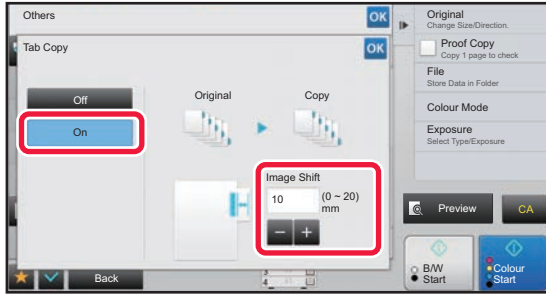

Sets an image shift width (tab width).

- Tap the numeric value display indicating the image shift width, and enter a shift width using numeric keys.
- After the settings are completed, tap **OK** and [Back] keys in sequence.



To cancel the tab copy setting:
Tap the [Off] key.

4

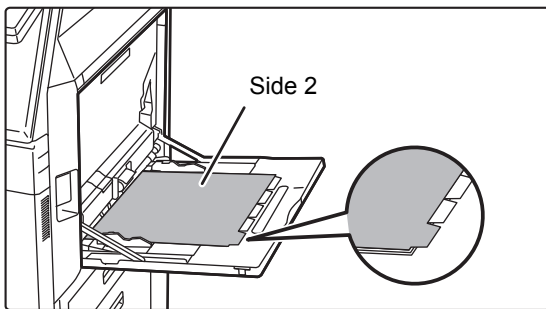

Load the tab paper.

When using the bypass tray, place the paper with the print side down.
Place the paper so that the sides with the tabs enter the machine last.
After loading tab paper into the bypass tray, configure the bypass tray settings as explained in "[MAKING COPIES USING THE BYPASS TRAY \(page 2-39\)](#)".



The width of the tab paper can be as wide as A4 width (210 mm) plus 20 mm (or 8-1/2" x 11" paper (8-1/2") plus 5/8").

5

Place the original and tap the [Preview] key.

Place the original in the document feeder tray of the automatic document feeder, or on the document glass.

- ▶ [AUTOMATIC DOCUMENT FEEDER \(page 1-84\)](#)
- ▶ [DOCUMENT GLASS \(page 1-86\)](#)



To cancel all settings:
Tap the [CA] key.

6

Tap the [Colour Start] or [B/W Start] key to start copying.



MAKING A POSTER-SIZED COPY (MULTI-PAGE ENLARGEMENT)

This function separately copies an enlarged original image on multiple sheets.

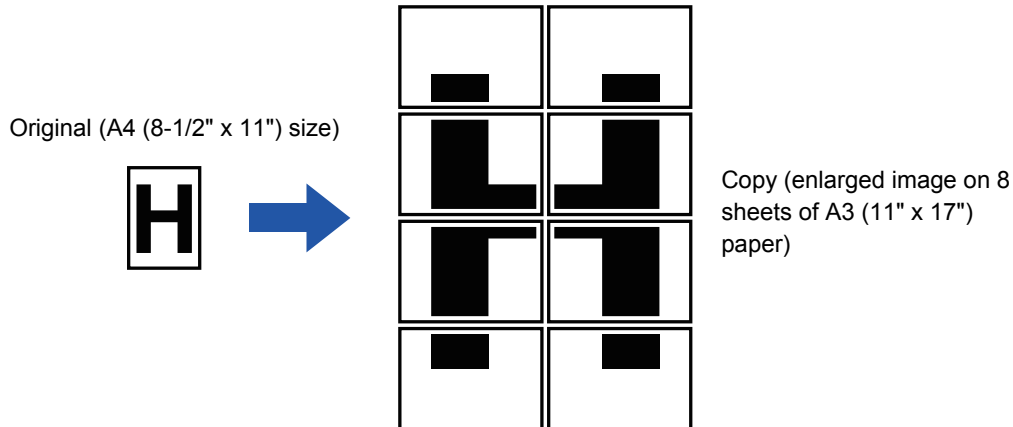

- You must select Multi-Page Enlargement before scanning the original.
- Place an original on the document glass.
- When Multi-Page Enlargement is selected, the image orientation is changed to vertical.
- Overlap of sections of image
 - There will be a margin around the edges of each copy.
 - Areas for overlapping the copies will be created at the leading and trailing edges of each copy.
- The paper size, number of sheets required for the enlarged image, and the ratio are automatically selected based on the selected original size and enlargement size. (The paper size and ratio cannot be selected manually.)

1

Tap the [Others] key, and tap the [Multi-Page Enlargement] key.

2

Select the [AB] or [Inch] tab to meet the original size for multi-page enlargement, and tap the key that meets the original size.

Tapping the key of the original size displays the keys that show the available enlargement size, copy paper size, and number of sheets.



3

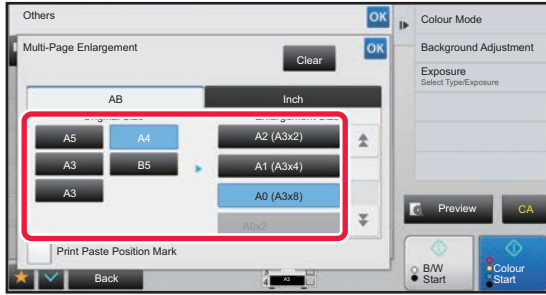

Tap the key of the size you want to enlarge the original to.

The image orientation appears.

After the settings are completed, tap **OK** and [Back] keys in sequence.



When printing the copy image and margin border, set the [Print Paste Position Mark] checkbox to .



• **To cancel Multi-Page Enlargement setting:**

Tap the [Clear] key.

Even when the multi-page enlargement setting is cancelled, the automatically selected ratio is retained.

• **To return the ratio to 100%:**

Tap the [Copy Ratio] key on the base screen to display the ratio menu, and then tap the [100%] key.

4

Place the original on the document glass based on the orientation displayed on the screen.

5

Tap the [Colour Start] or [B/W Start] key to start copying.



COPYING WITH MIRROR IMAGE (MIRROR IMAGE)

This function makes copies by inverting the original into a mirror image.

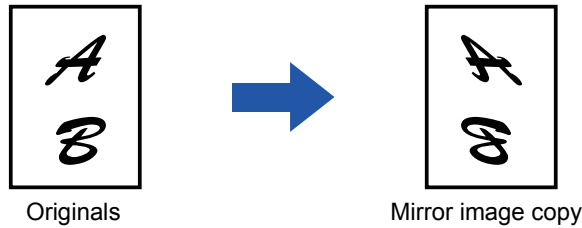

Specify the Mirror Image before scanning an original.

1

Tap the [Others] key, and tap the [Mirror Image] key.

A checkmark appears on the icon.

After the settings are completed, tap the [Back] key.



To cancel the mirror image setting:

Tap the [Mirror Image] key to uncheck it.

2

Place the original.

Place the original in the document feeder tray of the automatic document feeder, or on the document glass.

► [AUTOMATIC DOCUMENT FEEDER \(page 1-84\)](#)

► [DOCUMENT GLASS \(page 1-86\)](#)

3

Tap the [Colour Start] or [B/W Start] key to start copying.



OUTPUT AND DENSITY ADJUSTMENT FUNCTIONS

REVERSING WHITE AND BLACK IN A COPY (B/W REVERSE)

This function reverses black and white in a copy to create a negative image. This function can only be used for black and white copying.

Originals with large black areas (which use a large amount of toner) can be copied using Black/White Reverse to reduce toner consumption.



Originals

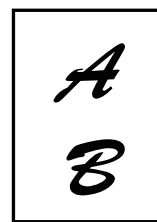
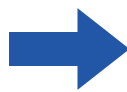

B/W reverse copy



- B/W Reverse must be specified before scanning the original.
- When this function is selected, the "Exposure/Original Type" setting for exposure adjustment automatically changes to "Text".
- This function is not available in some countries and regions.



When this function is selected, you cannot use the [Colour Start] key.

1

Tap the [Others] key, and tap the [B/W Reverse] key.

A checkmark appears on the icon.
After the settings are completed, tap the [Back] key.



To cancel the B/W reverse setting:
Tap the [B/W Reverse] key to uncheck it.

2

Place the original.

Place the original in the document feeder tray of the automatic document feeder, or on the document glass.

- ▶ [AUTOMATIC DOCUMENT FEEDER \(page 1-84\)](#)
- ▶ [DOCUMENT GLASS \(page 1-86\)](#)



To cancel all settings:
Tap the [CA] key.

3

Tap the [B/W Start] key to start copying.



EASY ADJUSTMENT OF THE IMAGE QUALITY (QUICK IMAGE QUALITY ADJUSTMENT)

You can easily adjust the colour and outlines of images and text.



You must select Quick Image Quality Adjustment before scanning the original.

1

Tap the [Others] key, and tap the [Quick Image Quality Adjustment] key.

2

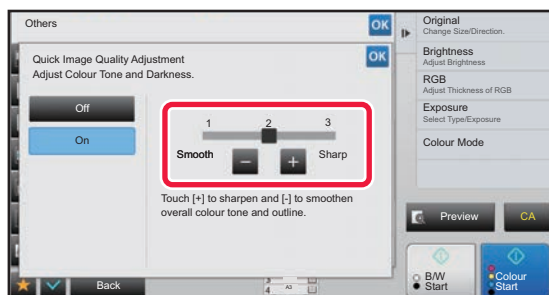

Tap **– +** or slide the slider to adjust the image quality.

After the settings are completed, tap **OK** and [Back] keys in sequence.



To cancel the quick image quality adjustment setting:

Tap the [Off] key.

3

Place the original.

Place the original in the document feeder tray of the automatic document feeder, or on the document glass.

► [AUTOMATIC DOCUMENT FEEDER \(page 1-84\)](#)

► [DOCUMENT GLASS \(page 1-86\)](#)



To cancel all settings:

Tap the [CA] key.

4

Tap the [Colour Start] or [B/W Start] key to start copying.



ADJUSTING RED/GREEN/BLUE IN COPIES (RGB ADJUST)

This function heightens or lightens any one of the three colour components R (red), G (green), and B (blue).

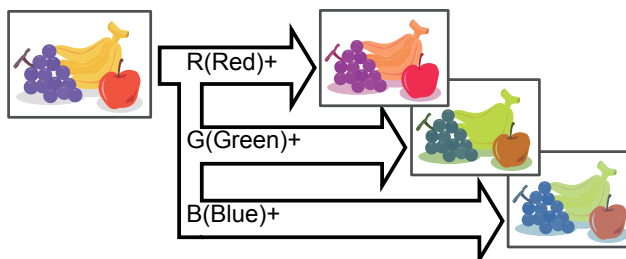

RGB must be specified before scanning the original.

1

Tap the [Others] key, and tap the [RGB Adjust] key.

2

Tap the key of the colour you want to adjust.

3

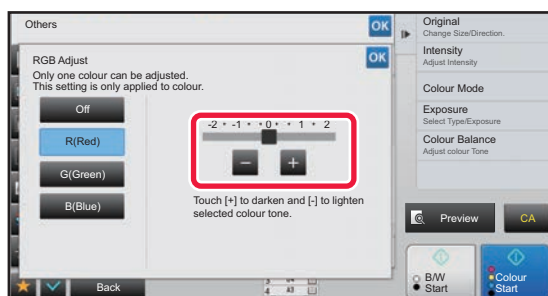

Tap **− +** or slide the slider to adjust the colouring.

After the settings are completed, tap **OK** and [Back] keys in sequence.



- Only one colour can be adjusted. (If you adjust one colour and then tap another colour, the adjustment of the first colour is cancelled.)
- **To cancel the RGB adjust setting:**
Tap the [Off] key.

4

Place the original.

Place the original in the document feeder tray of the automatic document feeder, or on the document glass.

- [AUTOMATIC DOCUMENT FEEDER \(page 1-84\)](#)
- [DOCUMENT GLASS \(page 1-86\)](#)



To cancel all settings:
Tap the [CA] key.

5

Tap the [Colour Start] key to start copying.



ADJUSTING THE SHARPNESS OF AN IMAGE (SHARPNESS)

This function adjusts the sharpness to make a sharper or softer image.

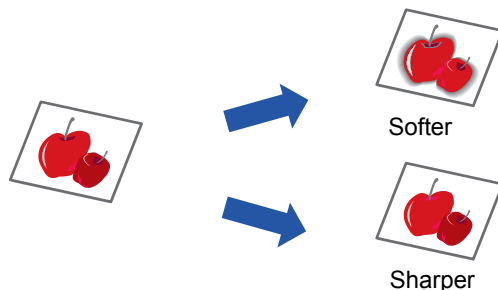

Sharpness must be specified before scanning the original.

1

Tap the [Others] key, and tap the [Sharpness] key.

2

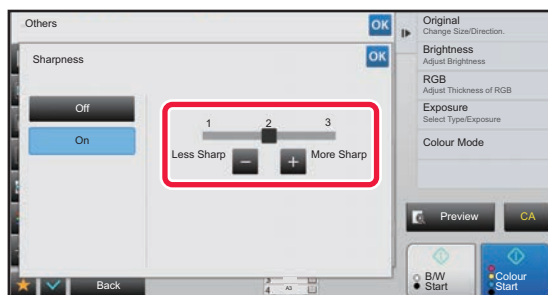

Tap **−** **+** or slide the slider to adjust the sharpness.

Select [More Sharp] for sharper outlines, or [Less Sharp] for softer outlines.

After the settings are completed, tap **OK** and [Back] keys in sequence.



To cancel the sharpness setting:

Tap the [Off] key.

3

Place the original.

Place the original in the document feeder tray of the automatic document feeder, or on the document glass.

► [AUTOMATIC DOCUMENT FEEDER \(page 1-84\)](#)

► [DOCUMENT GLASS \(page 1-86\)](#)



To cancel all settings:

Tap the [CA] key.

4

Tap the [Colour Start] or [B/W Start] key to start copying.



ADJUSTING THE COLOUR (COLOUR BALANCE)

You can adjust the colour, tone, and density of copies.

Use the [Colour] tab for colour copy settings, or the [B/W] tab for black & white copy settings.

If you select the [Colour] tab, the densities of the colours yellow, magenta, cyan, and black are divided into three ranges, and you can adjust the density of each range.

If needed, you can also adjust all three density ranges at once.

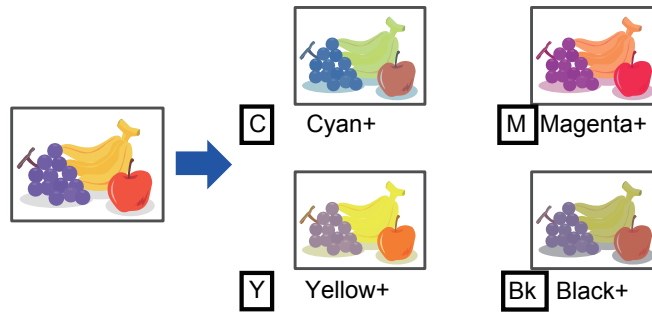

Colour Balance must be specified before scanning the original.



To change the default colour balance setting:

Change the setting in "Settings (administrator)" → [System Settings] → [Image Quality Adjustment] → [Copy Image Quality] → [Colour Balance (Colour)] or [Colour Balance (Black & White)].

1

Tap the [Others] key, and tap the [Colour Balance] key.

2

Tap the tab of the mode you want to adjust.



3

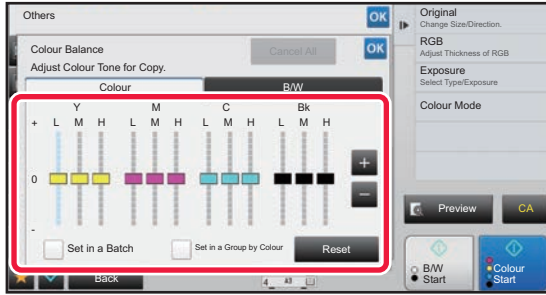

Tap the **- +** key or slide the slider to adjust the colour balance.

- If you want to adjust each colour individually on the [Colour] tab, set the [Set in a Batch] checkmark to . If you want to further adjust each range of each colour individually, set the [Set in a Group by Colour] checkbox to .
- To adjust each range on the [B/W] tab, set the [Set in a Batch] checkbox to .
- To adjust a slider individually with the **- +** keys, tap the slider you want to adjust and tap the **- +** keys.



• **To return the colour balance of the current tab to the default balance:**

Tap the [Reset] key.

The values of all gradations currently being adjusted will return to their default colour balance values.

• **To return all colour balances to defaults:**

Tap the [Cancel All] key.

The default settings are the values set in "Settings (administrator)" → [System Settings] → [Image Quality Adjustment] → [Copy Image Quality] → [Colour Balance (Colour)] or [Colour Balance (Black & White)].

4

Place the original.

Place the original in the document feeder tray of the automatic document feeder, or on the document glass.

- ▶ [AUTOMATIC DOCUMENT FEEDER \(page 1-84\)](#)
- ▶ [DOCUMENT GLASS \(page 1-86\)](#)

5

Tap the [Colour Start] or [B/W Start] key to start copying.



ADJUSTING THE BRIGHTNESS OF A COPY (BRIGHTNESS)

This function adjusts the brightness of a colour copy image.

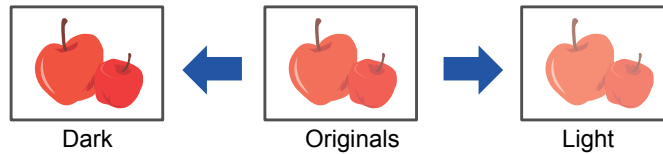

Brightness must be specified before scanning the original.

1

Tap the [Others] key, and tap the [Brightness] key.

2

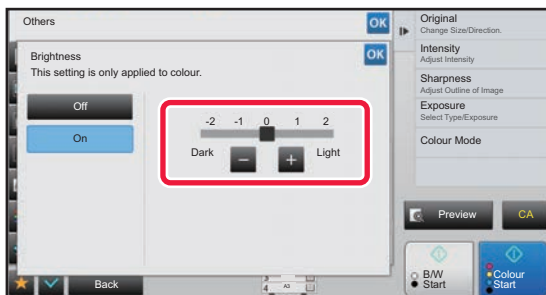

Tap the **- +** key or slide the slider to adjust the brightness.

After the settings are completed, tap **OK** and [Back] keys in sequence.



To cancel the brightness setting:

Tap the [Off] key.

3

Place the original.

Place the original in the document feeder tray of the automatic document feeder, or on the document glass.

► [AUTOMATIC DOCUMENT FEEDER \(page 1-84\)](#)

► [DOCUMENT GLASS \(page 1-86\)](#)



To cancel all settings:

Tap the [CA] key.

4

Tap the [Colour Start] key to start copying.



ADJUSTING THE INTENSITY OF A COPY (INTENSITY)

This function adjusts the intensity (saturation) of a colour copy image.

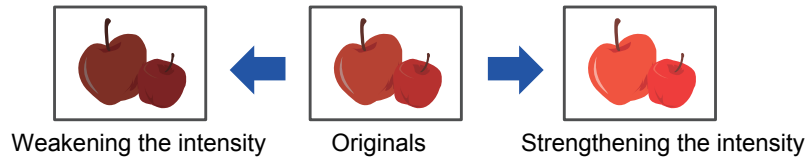

You must set the intensity before scanning the original.



This function cannot be combined with [Copy of Copy] or [Colour Tone Enhancement] in Exposure.

1

Tap the [Others] key, and tap the [Intensity] key.

2

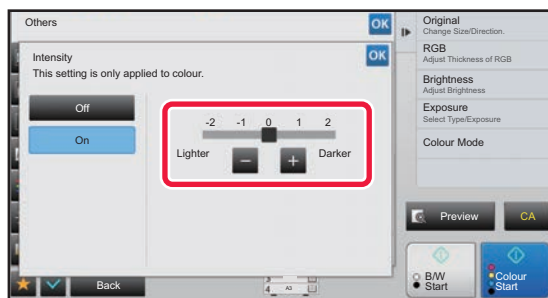

Tap **- +** the key or slide the slider to adjust the intensity.

After the settings are completed, tap **OK** and [Back] keys in sequence.



To cancel the Intensity setting:

Tap the [Off] key.

3

Place the original.

Place the original in the document feeder tray of the automatic document feeder, or on the document glass.

► [AUTOMATIC DOCUMENT FEEDER \(page 1-84\)](#)

► [DOCUMENT GLASS \(page 1-86\)](#)



To cancel all settings:

Tap the [CA] key.

4

Tap the [Colour Start] key to start copying.



CONVENIENT COPY FUNCTIONS

INTERRUPT COPY

This function suspends a job in progress, and preferentially prints the original specified with interrupt copy. When you need to make an urgent copy and the machine is busy with a long copy run or other job, use interrupt copy.

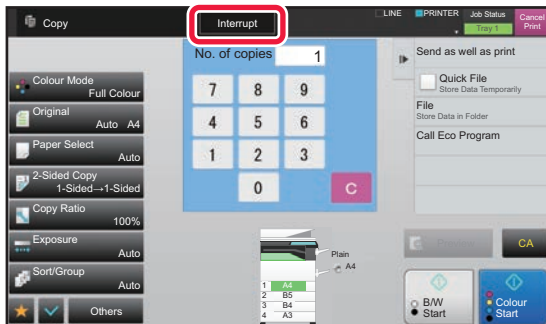

- The [Interrupt] key does not appear while an original is being scanned.
- Depending on the settings of the job in progress, the [Interrupt] key may not appear.
- Interrupt copy cannot be used in combination with the following functions: Job Build, Tandem Copy, Book Copy, Card Shot, Multi-Page Enlargement, Original Count, Proof Copy, Preview Setting, and Book Divide.
- If you use the document glass for interrupt copy, you cannot select the booklet, covers/inserts function, or N-Up setting. If any of these functions are necessary, use the automatic document feeder.

1**Tap the [Interrupt] key.**

The interrupt mode screen appears.

**If user authentication is specified:**

Tap the [Interrupt] key to display the user authentication screen. Enter the login name and password to perform user authentication.

2**Place the original.**

Place the original in the document feeder tray of the automatic document feeder, or on the document glass.

- ▶ [AUTOMATIC DOCUMENT FEEDER \(page 1-84\)](#)
- ▶ [DOCUMENT GLASS \(page 1-86\)](#)

3**Configure copy settings.**

To cancel interrupt copy, tap the [Cancel] key.



4

Tap the [Colour Start] or [B/W Start] key to start interrupt copying.

When the interrupt copy job is completed, the interrupted job will resume.



The interrupt copy function does not display the preview of the scanned original.



SEND DATA WHILE COPYING

This function allows you to send a fax while making a copy, send an e-mail with an image attached, or save data in the network folder.



You need to store the destination in the address book in advance.

► [ADDRESS BOOK \(page 1-98\)](#)

The fax and image send transmission starts after the copy, and the settings same as the copy are used for transmission. However, the same results as the copy may not be provided by some functions.

1

Tap the [Detail] key to change to normal mode.

► [Changing mode from each mode \(page 2-5\)](#)

2



Tap [Send as well as print] on the action panel.

3

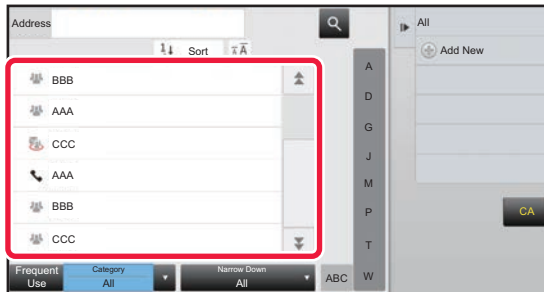

Select a recipient from the address book.

► [ADDRESS BOOK SCREEN \(page 1-99\)](#)

After you have selected the recipient, tap the [Enter Address] key.



• You cannot use the soft keyboard to enter an address. If you cannot find the recipient in the address book, enter it in the address book.

• An Internet Fax address cannot be selected.

4

Place the original.

Place the original in the document feeder tray of the automatic document feeder, or on the document glass.

► [AUTOMATIC DOCUMENT FEEDER \(page 1-84\)](#)

► [DOCUMENT GLASS \(page 1-86\)](#)



5

Set each copy item as required.

These copy settings are used for fax transmission. However, some settings may be unavailable depending on the function.



You can preview the scanned original by tapping the [Preview] key.

6

Tap the [Colour Start] or [B/W Start] key to start copying.

After the copy, the transmission starts.



After the copy, you cannot preview the settings before transmission.



COPY JOBS

When you tap the job status display, jobs are displayed in a list. To check the status of a copy job, tap the [Print] tab. When you wish to stop or delete jobs or to perform priority processing, read the following items:

- ▶ [STOPPING/DELETING A JOB IN PROGRESS OR RESERVED \(page 1-90\)](#)
- ▶ [PRIORITY PROCESSING OF A RESERVED JOB \(page 1-91\)](#)
- ▶ [CHECKING A RESERVED JOB OR THE JOB IN PROGRESS \(page 1-93\)](#)
- ▶ [CHECKING COMPLETED JOBS \(page 1-94\)](#)





PROGRAMS

Programs are set from the base screen of normal mode.

► [SELECTING COPY MODE \(page 2-4\)](#)



Programs cannot be stored in easy mode.

STORING A PROGRAM

This function collectively stores copy settings as one program. The stored program can be retrieved using an easy operation.

For information about how to retrieve a program, see "[RETRIEVING A PROGRAM \(page 2-142\)](#)".

For example, suppose A3 (11" x 17") size CAD drawings are copied once a month for archive purposes using the following settings:

- The A3 (11" x 17") size CAD drawings are reduced to A4 (8-1/2" x 11") size.
- To reduce paper use by half, 2-sided copying is used.
- Margin shift is used to allow a margin to punch holes for filing.

A3 (11" x 17") size CAD drawings

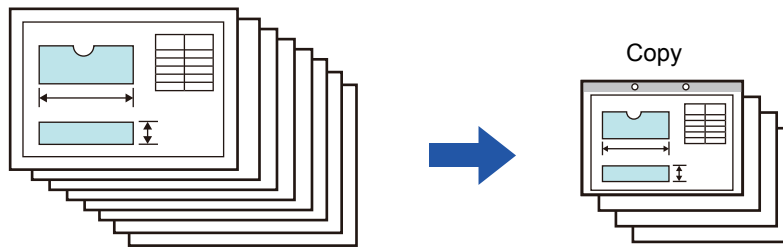

When a job program is not stored	When a job program is stored
<p>Set reduction from A3 (11" x 17") to A4 (8-1/2" x 11")</p> <p style="text-align: center;">↓</p> <p>Change the exposure setting.</p> <p style="text-align: center;">↓</p> <p>Set 2-sided copying.</p> <p style="text-align: center;">↓</p> <p>Set margins.</p> <p style="text-align: center;">↓</p> <p>Set punch hole settings.</p> <p style="text-align: center;">↓</p> <p>Tap the [Colour Start] or [B/W Start] key.</p>	<p>Retrieve the stored program.</p> <p style="text-align: center;">↓</p> <p>Tap the [Colour Start] or [B/W Start] key.</p>
<p>Considerable time is required to copy the drawings each month because the above settings must be selected. In addition, mistakes are occasionally made when selecting the settings, so some copies must be redone.</p>	<p>The settings are stored in a program, so they can be selected by the touch of a key. This is simple and takes no time. In addition, the settings are all stored so there are no chances for mistakes, and thus no need to redo copies due to setting mistakes.</p>



- Up to 48 programs can be stored.
- Program settings remains registered even when the main power has been turned off.
- A program can also be stored in the home screen or favourite as a shortcut; therefore, it is helpful when retrieving it.

1

Specify the copy function to be stored.



In the base screen, display [Program Registration] on the action panel.

2

Tap [Program Registration] on the action panel.

3

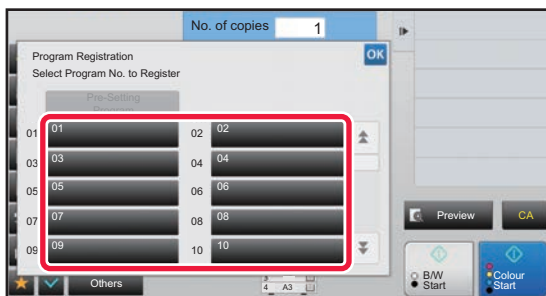

Tap an unused key.

A key with a program stored is displayed in colour. Tap a key with no program stored.



If you do not set a name for the program, a serial number will be automatically assigned as the name.

4

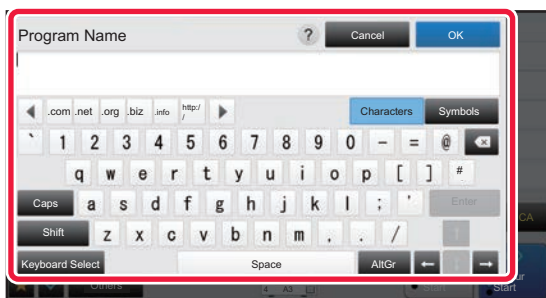

Set a name for the program and tap the [OK] key.

A registration completion message appears.



5

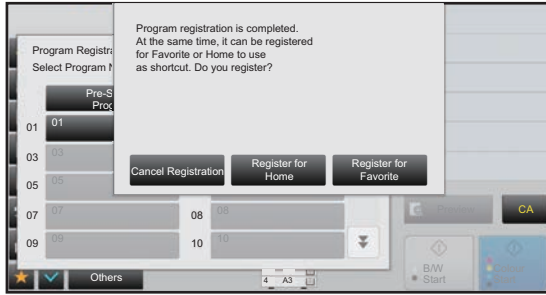

Select whether or not the program will be added to the home screen or the favourites.

To specify print settings, you can select the required one from pre-set text or use the soft keyboard. You can also print serial number and account job ID.

When you have completed the settings, tap **OK** and the [Back] keys in sequence.



- If user authentication is enabled, the shortcut key for the program is registered in the user's home screen or favourite.
- If user authentication is disabled, the administrator password entry screen appears. When the administrator password is entered, the registration is completed.



The number of copies cannot be stored.

RETRIEVING A PROGRAM

1

Tap [Call Program] on the action panel.

2

Tap the key of the program you want to retrieve.



You can select a program key and tap [Register in Favorite] or [Register for Home] on the action panel to register a shortcut key for the selected program in the favourite or home screen.

DELETING AND RENAMING A PROGRAM

This section explains how to delete copy settings in a program and rename a program.



- A program that is already stored cannot be deleted.
- When "Settings (administrator)" - [System Settings] → [Common Settings] → [Enable/Disable Settings] → [Disabling of Registration/Deletion of Program] is selected, a registered program cannot be deleted or renamed.

Deleting a program

1

Tap [Call Program] on the action panel.



2

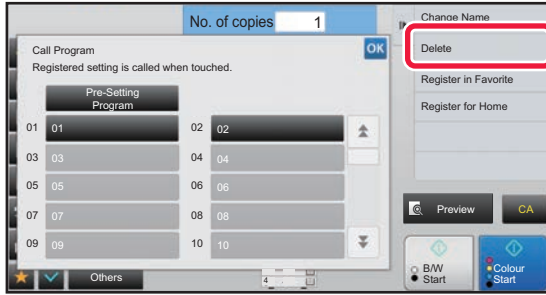

Tap [Delete] on the action panel.

3

Tap the key of the program you want to delete, and tap [Delete].

Renaming a program

1

Tap [Call Program] on the action panel.

2

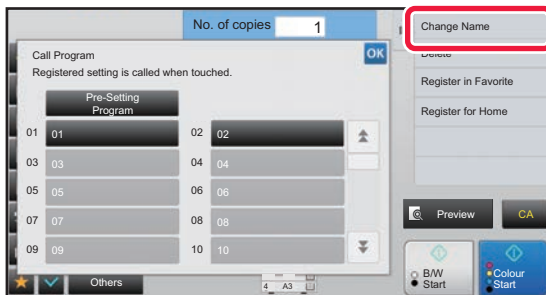

Tap [Change Name] on the action panel.

3



Tap the key of the required program, and rename the program. Then tap the [OK] key.

After the settings are completed, tap **OK**.



PRINTER

Icons

-  Eco-friendly functions
-  Functions for printing on special media

The explanations in this chapter are based on American English and the North American version of the software. Software for other countries and regions may vary slightly from the North American version.

PRINTER FUNCTION OF THE MACHINE





PRINTING IN A WINDOWS ENVIRONMENT

BASIC PRINTING PROCEDURE	3-4
• PRINTER DRIVER SETTINGS SCREEN / REFERRING TO HELP	3-6
• SELECTING THE PAPER	3-7
 • PRINTING ON ENVELOPES	3-8
PRINTING WHEN THE USER AUTHENTICATION FUNCTION IS ENABLED	3-9
FREQUENTLY USED FUNCTIONS	3-11
• SAVING SETTINGS AT THE TIME OF PRINTING	3-11
• USING SAVED SETTINGS	3-12
• CHANGING THE PRINTER DRIVER DEFAULT SETTINGS	3-12

PRINTING IN A Mac OS ENVIRONMENT

BASIC PRINTING PROCEDURE	3-14
• SELECTING THE PAPER	3-15
 • PRINTING ON ENVELOPES	3-16
PRINTING WHEN THE USER AUTHENTICATION FUNCTION IS ENABLED	3-17

FREQUENTLY USED FUNCTIONS

 SELECTING THE COLOR MODE	3-19
SELECTING THE RESOLUTION	3-21
 2-SIDED PRINTING	3-22
FITTING THE PRINT IMAGE TO THE PAPER	3-23
 PRINTING MULTIPLE PAGES ON ONE PAGE ...	3-25
 PRINTING WHILE SKIPPING BLANK PAGES	3-27
STAPLING OUTPUT/PUNCHING HOLES IN OUTPUT	3-28

CONVENIENT PRINTING FUNCTIONS

CONVENIENT FUNCTIONS FOR CREATING PAMPHLETS AND POSTERS	3-30
• CREATE A PAMPHLET (BOOKLET/SADDLE STITCH)	3-30
• PRINTING WITH MARGIN SHIFT SETTING (MARGIN)	3-32
• CREATE A LARGE POSTER (POSTER PRINTING)	3-34
FUNCTIONS TO ADJUST THE SIZE AND ORIENTATION OF THE IMAGE	3-35
• ADJUST PRINT POSITION ON ODD AND EVEN PAGES SEPARATELY (PRINT POSITION)	3-35
• ROTATING THE PRINT IMAGE 180 DEGREES (ROTATE 180 DEGREES)	3-36
• ENLARGING/REDUCING THE PRINT IMAGE (ZOOM SETTING/ENLARGE OR REDUCE) ...	3-37
• ADJUST THE LINE THICKNESS (WIDTH) ...	3-39
• PRINT A MIRROR-IMAGE (MIRROR-IMAGE REVERSE/VISUAL EFFECTS)	3-41
COLOR MODE ADJUSTING FUNCTION	3-42
• ADJUST THE BRIGHTNESS AND CONTRAST OF THE IMAGE (COLOR ADJUSTMENT/RGB ADJUSTMENT)	3-42
• PRINTING FAINT TEXT AND LINES IN BLACK (TEXT TO BLACK/VECTOR TO BLACK) ...	3-44
• SELECTING COLOR SETTINGS TO MATCH THE IMAGE TYPE (ADVANCED COLOR SETTINGS)	3-45
FUNCTIONS TO COMBINE TEXT AND IMAGES ...	3-48
• ADDING A WATERMARK TO PRINTED PAGES (WATERMARK)	3-48
• PRINTING AN IMAGE OVER THE PRINT DATA (IMAGE STAMP)	3-50
• REGISTERING A CUSTOM IMAGE	3-51
• OVERLAY A FIXED FORM ON THE PRINT DATA (OVERLAYS)	3-52
• ADDING THE NUMBER OF COPIES (COPIES STAMP)	3-54





PRINT FUNCTIONS FOR SPECIAL PURPOSES. . . 3-55



- PRINTING SPECIFIC PAGES ON DIFFERENT PAPER (DIFFERENT PAPER) 3-55
- ADDING INSERTS WHEN PRINTING ON TRANSPARENCY FILM (TRANSPARENCY INSERTS) 3-57
- INSERTING SEPARATOR PAGES BETWEEN JOBS OR COPIES 3-59
- PRINTING A CARBON COPY (CARBON COPY) 3-60
- PRINTING TEXT ON TABS OF TAB PAPER (TAB SHIFT/TAB PAPER PRINT) 3-61
- TWO-SIDED PRINTING WITH SPECIFIC PAGES PRINTED ON THE FRONT SIDE (CHAPTER INSERTS) 3-64
- FOLDING PRINTED PAPER IN HALF (FOLD) 3-65
- INSERT PRESET DATA BEFORE OR AFTER EACH PAGE (PAGE INTERLEAVE) 3-67
- PRINT THE SAME IMAGE IN TILE PATTERN (REPEAT PRINT) 3-68
- PRINTING PATTERN DATA (HIDDEN PATTERN PRINT) 3-69
- CHANGING THE RENDERING METHOD AND PRINTING JPEG IMAGES (USE DRIVER TO RENDER JPEGS) 3-71
- MAXIMIZING THE PRINT AREA ON THE PAPER (PRINT AREA) 3-72
- PRINTING AT AN ENHANCED RESOLUTION (SMOOTHING) 3-73

CONVENIENT PRINTER FUNCTIONS 3-74

- USING TWO MACHINES TO PRINT A LARGE PRINT JOB (TANDEM PRINT) 3-74
- SAVING AND USING PRINT FILES (DOCUMENT FILING) 3-76
- AUTOMATICALLY PRINT ALL STORED DATA 3-78
- PRINTING AND SENDING SIMULTANEOUSLY 3-79

PRINTER JOBS

- CHECKING THE PRINT STATUS 3-88**
- PRINTING AN ENCRYPTED PDF FILE 3-88**
- CHANGING TO ANOTHER PAPER SIZE AND PRINTING WHEN PAPER RUNS OUT 3-89**

APPENDIX

- PRINTER DRIVER SPECIFICATIONS LIST 3-90**
- SPECIFYING A BILLING CODE USING THE PRINTER DRIVER 3-93**
- AUTHENTICATION BY SINGLE SIGN-ON 3-95**
- PRINTING BY GOOGLE CLOUD PRINT 3-96**

PRINTING WITHOUT THE PRINTER DRIVER

- EXTENSION OF PRINTABLE FILES 3-80**
- DIRECTLY PRINTING A FILE ON AN FTP SERVER 3-80**
- DIRECTLY PRINTING A FILE IN USB MEMORY 3-82**
- DIRECTLY PRINTING A FILE IN A NETWORK FOLDER 3-83**
- DIRECTLY PRINTING FROM A COMPUTER 3-86**
 - SUBMIT PRINT JOB 3-86
 - FTP PRINT 3-86
 - E-MAIL PRINT 3-86



PRINTER FUNCTION OF THE MACHINE

The machine is equipped with a full color printing function as standard. To enable printing from your computer, a printer driver must be installed.

See the table below to determine which printer driver to use in your environment.

Windows environment

Printer driver type
PCL6 The machine support the Hewlett-Packard PCL6 printer control languages.
PS <ul style="list-style-type: none">• This printer driver supports the PostScript® 3™ page description language developed by Adobe Systems Incorporated.• If it is desired to use the Windows standard PS printer driver, the PPD driver must be used.



- To install the printer driver and configure settings in a Windows environment, see the Software Setup Guide.
- The User's Manual mainly uses PCL6 printer driver screens to explain how to print in a Windows environment. The printer driver screens may differ slightly depending on the printer driver you are using.

Mac OS Environment

Printer driver type
PS PS This printer driver supports the PostScript® 3™ page description language developed by Adobe Systems Incorporated and uses a PPD file.



- To install the printer driver and configure settings in a Mac OS environment, see the Software Setup Guide.



PRINTING IN A WINDOWS ENVIRONMENT

BASIC PRINTING PROCEDURE

The following example explains how to print a document from "WordPad", which is a standard accessory application in Windows.



- The menu used to execute printing may vary depending on the application.
- The button that is used to open the printer driver properties window (usually [Property] or [Preferences]) may vary depending on the application.
- The machine name that normally appears in the [Printer] menu is [MX-xxxx]. ("xxxx" is a sequence of characters that varies depending on the machine model.)

1

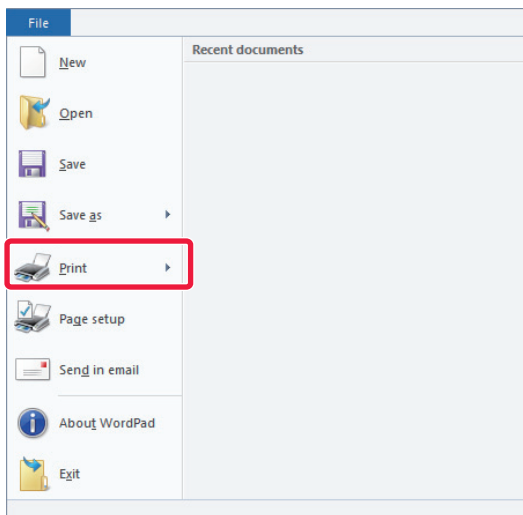

Select [Print] from the [File] menu of WordPad.

2

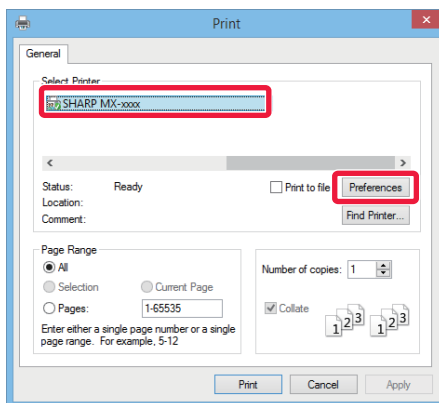

Select the printer driver for the machine and click the [Preferences] button.

The button that is used to open the printer driver properties window (usually [Property] or [Preferences]) may vary depending on the application.



3

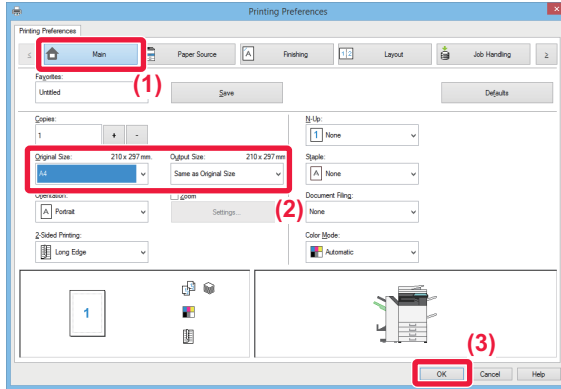

Select print settings.

(1) Click the [Main] tab.

(2) Select the original size.

- You can register up to seven user-defined sizes in the menu. To store an original size, select [Custom Paper] or one of [User1] to [User7] from the menu, and click the [OK] button.
- To select settings on other tabs, click the desired tab and then select the settings.
 - ▶ [PRINTER DRIVER SETTINGS SCREEN / REFERRING TO HELP \(page 3-6\)](#)
- If an original size larger than the largest paper size that the machine supports is set, select the paper size for printing in "Output Size".
- If an "Output Size" different from the "Original Size" is selected, the print image will be adjusted to match the selected paper size.

(3) Click the [OK] button.

4

Click the [Print] button.

Printing begins.



PRINTER DRIVER SETTINGS SCREEN / REFERRING TO HELP

The printer driver settings screen consists of 9 tabs. Click a tab to select the settings on that tab.

You can check information on each of the settings in the Help screen. Click the [Help] button at the bottom right of the screen.

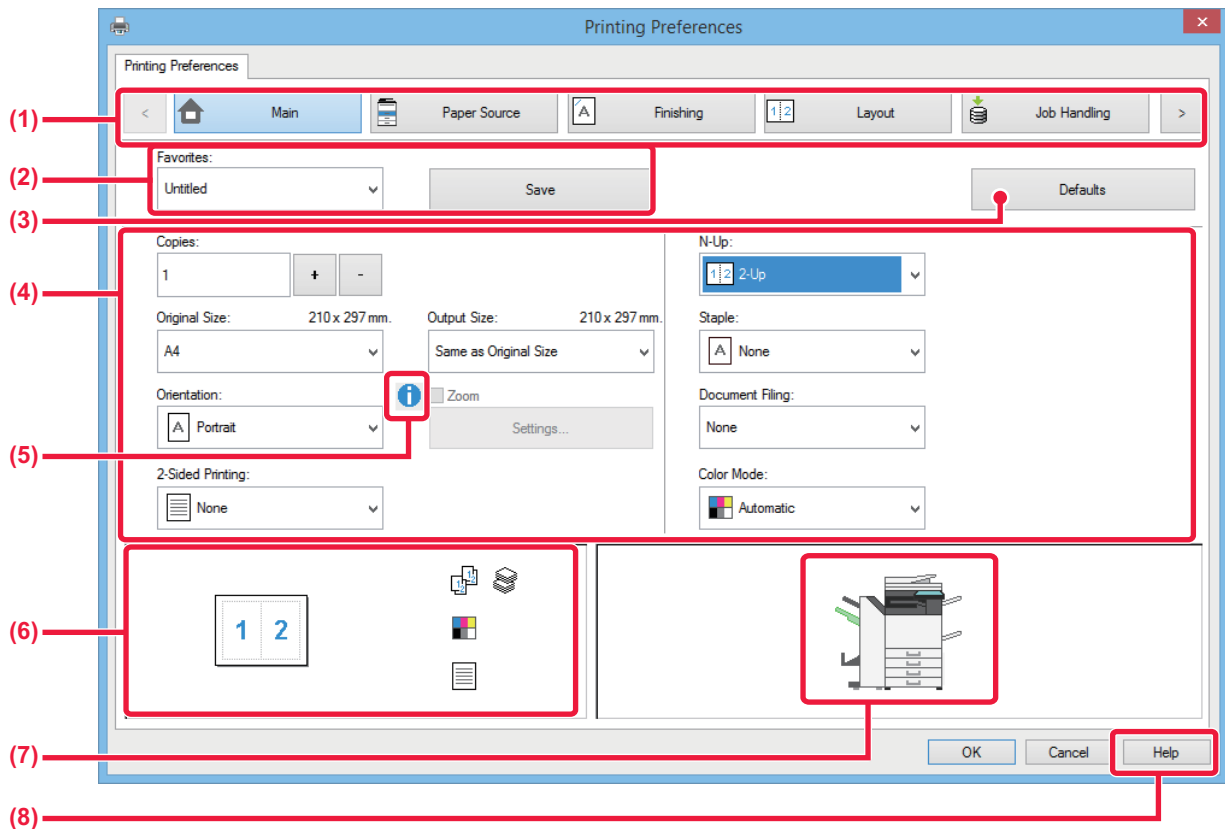

(1) Tabs: Click to change the tabs shown.

- [Main]: Frequently used functions are grouped on this tab. The settings are also on other tabs, and each setting on this tab is linked to the corresponding setting on the other tab.
- [Paper Source]: Set the size and type of paper used for printing, and the paper tray.
- [Finishing]: Select a finishing function such as stapling, punch, or folding, and set the output tray.
- [Layout]: Select functions related to the layout such as two-sided printing and booklet.
- [Job Handling]: Set Document Filing and user authentication.
- [Inserts]: Select insertion functions such as covers, inserts, and tab paper.
- [Stamp]: Select the watermark or stamp function.
- [Image Quality]: Select various image quality settings.
- [Detailed Settings]: Select tandem print and other detailed print settings.

(2) Favorites

Settings configured on each tab at the time of printing can be saved as Favorite.

▶ [FREQUENTLY USED FUNCTIONS \(page 3-11\)](#)

(3) [Defaults]

Return the settings on the currently selected tab to their default state.

(4) Setup Items

Displays the settings on each tab.

(5) Information icon ()

Some restrictions exist on the combinations of settings that can be selected in the printer driver properties window. When a restriction exists on a selected setting, an information icon () will appear next to the setting. Click the icon to view an explanation of the restriction.



(6) Print image

This lets you visually check how the current settings affect the print image. Finishing settings and the color mode are indicated by icons.

(7) Machine image

This shows the options that are installed on the machine, and the paper trays and output trays that are used.

(8) [Help] button

Displays the Help window of the printer driver.



- Help can be displayed for a setting by clicking the setting and pressing the [F1] key.
- You can click the  button in the upper right corner of the settings screen and then click a setting to show Help for that setting in a sub-window.

SELECTING THE PAPER

Before printing, check the paper sizes, paper types, and paper remaining in the machine's trays. To check the most recent tray information, click the [Tray Status] button in the [Paper Source] tab.

The "Output Size" setting and the "Paper Tray" setting are related as follows:

• **When "Paper Tray" is set to [Auto Select]**

The tray that contains paper of the size and type selected in "Output Size" and "Paper Type" is automatically selected.

• **When "Paper Tray" is set to any setting other than [Auto Select]**

The specified tray is used for printing regardless of the "Output Size" setting.

When you have set "Paper Type" to [Bypass Tray], be sure to select "Paper Type". Check the paper type that is set for the bypass tray of the machine, check that paper of that type is actually loaded into the bypass tray, and then select the appropriate paper type.

• **When "Paper Type" is set to [Auto Select]**

A tray with plain paper or recycled paper of the size specified in "Output Size" is automatically selected. (The factory default setting is plain paper only.)

• **When "Paper Type" is set to anything other than [Auto Select]**

A tray with the specified type of paper and the size specified in "Output Size" is used for printing.



Special media such as envelopes can also be placed in the bypass tray.

For the procedure for loading paper in the bypass tray, see "[LOADING PAPER INTO THE BYPASS TRAY \(page 1-78\)](#)".



When [Enable Detected Paper Size in Bypass Tray] (disabled by factory default) or [Enable Selected Paper Type in Bypass Tray] (disabled by factory default), which you can reach by selecting [System Settings] in "Settings (administrator)" → [Printer Settings] → [Condition Settings] → [Bypass Tray Settings] is enabled, printing will not take place if the paper size or paper type specified in the printer driver is different from the paper size or paper type specified in the settings of the bypass tray.



To exclude the bypass tray from the trays that can be selected when [Auto Select] is selected:

In "Settings (administrator)", select [System Settings] → [Printer Settings] → [Condition Settings] → [Bypass Tray Settings] → [Exclude Bypass-Tray from Auto Paper Select].

If special media are frequently loaded in the bypass tray, it is recommended that this setting be enabled.



PRINTING ON ENVELOPES

The bypass tray can be used for envelope printing.



- For the types of paper that can be used in the bypass tray, see "[APPLICABLE PAPER TYPES \(page 1-68\)](#)".
- For the procedure for loading paper in the bypass tray, see "[LOADING PAPER INTO THE BYPASS TRAY \(page 1-78\)](#)".
- For more information on the procedure for loading paper, see "[SELECTING THE PAPER \(page 3-7\)](#)".
- It is recommended that you carry out a test print to check the print result before using an envelope.
- When using media such as envelopes that can be loaded only in a specific orientation, you can rotate the image 180 degrees. For more information, see "[ROTATING THE PRINT IMAGE 180 DEGREES \(ROTATE 180 DEGREES\) \(page 3-36\)](#)".

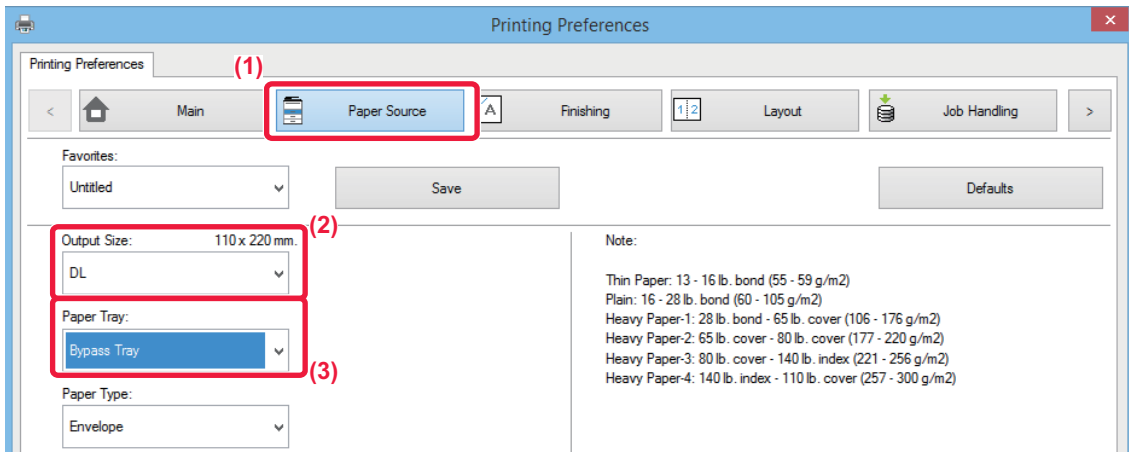

(1) Click the [Paper Source] tab.

(2) Select the envelope size from the "Output Size" menu.

When [Output Size] is set to envelope, [Paper Type] is automatically set to [Envelope].

When "Original Size" is set to envelope on the [Main] tab and "Output Size" is set to [Same as Original Size], "Paper Type" is automatically set to [Envelope].

(3) Select [Bypass Tray] in "Paper Tray".

When [Enable Selected Paper Type in Bypass Tray] (disabled by factory default) is enabled in "Settings (administrator)", set the paper type of the bypass tray to [Envelope].



PRINTING WHEN THE USER AUTHENTICATION FUNCTION IS ENABLED

The user information (such as login name and password) that must be entered varies depending on the authentication method being used, so check with the administrator of the machine before printing.



- If you have configured "Printing Policy" on the [Configuration] tab so that user authentication is always performed, users are required to be authenticated for each print job. This is done by entering authentication information in a dialog box that appears each time printing is performed.
- The machine's user authentication function cannot be used when the PPD driver* is installed and the Windows standard PS printer driver is used.
For this reason, the machine can be configured to prohibit users from executing printing unless their user information is stored in the machine.
* The PPD driver enables the machine to print using the Windows standard PS printer driver.



To prohibit printing by users whose user information is not stored in the machine:
In "Settings (administrator)", select [User Control] → [Default Settings] → [Disable Printing by Invalid User].

1

In the printer driver properties window of the application, select the printer driver of the machine and click the [Preferences] button.

The button that is used to open the printer driver properties window (usually [Property] or [Preferences]) may vary depending on the application.



2

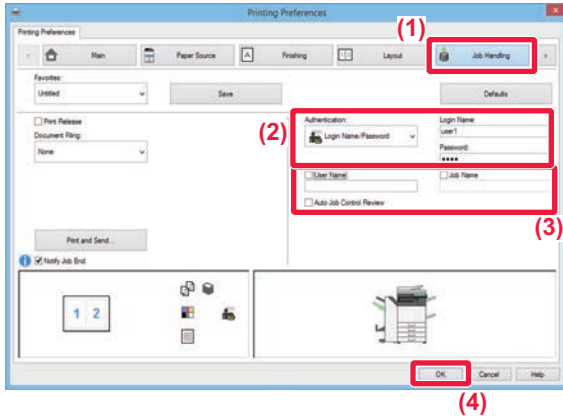

Enter your user information.

(1) Click the [Job Handling] tab.

(2) Enter your user information.

- When authentication is performed by login name, select [Login Name] and enter your login name.
- When authentication is performed by login name/password, click [Login Name/Password] and enter your login name and password. Enter the password using 1 to 32 characters
- When the machine's authentication destination is Active Directory, [Single Sign-on] can be selected. For information on single sign-on, refer to ["AUTHENTICATION BY SINGLE SIGN-ON \(page 3-95\)"](#).
- When authentication is performed by user number, select [User Number] and enter your 5 to 8 digit user number.

(3) Enter the user name and job name as necessary.

- Click the [User Name] checkbox, and enter your user name using up to 32 characters. The entered user name will appear on the touch panel of the machine. If you do not enter a user name, your PC login name will appear.
- Click the [Job Name] checkbox, and enter a job name using up to 30 characters. The entered job name will appear as a file name on the touch panel of the machine. If you do not enter a job name, the file name set in the application will appear.
- To have a confirmation window appear before printing starts, select the [Auto Job Control Review] checkbox.

(4) Click the [OK] button to execute printing.



Authentication by Single Sign-on requires that Active Directory authentication be performed on the machine and your computer. This can only be used when your computer is running Windows.



FREQUENTLY USED FUNCTIONS

SAVING SETTINGS AT THE TIME OF PRINTING

Settings configured on each of the tabs at the time of printing can be saved as Favorite. Saving frequently used settings or complex color settings under an assigned name makes it easy to select those settings the next time you need to use them.

Settings can be saved from any tab of the printer driver properties window. Settings configured on each tab are listed at the time of saving, allowing you to check the settings as you save them.



Deleting saved settings

In step 2 of "[USING SAVED SETTINGS \(page 3-12\)](#)", select the user settings that you want to delete and click the [Delete] button.

1

Select the machine's printer driver from the print window of the application, and click the [Preferences] button.



The button that is used to open the printer driver properties window (usually [Property] or [Preferences]) may vary depending on the application.

2

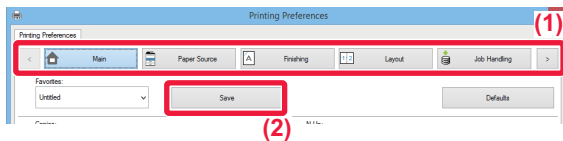

Register Print Settings.

- (1) Configure the print settings on each tab.
- (2) Click the [Save] button.

3

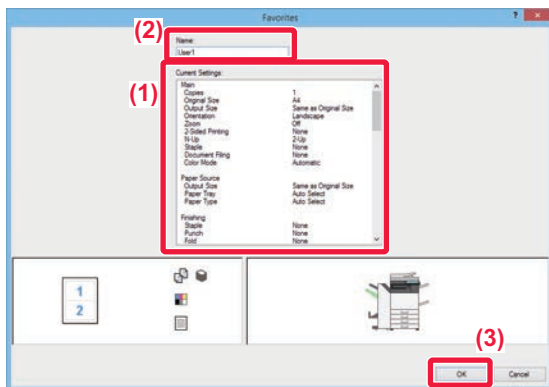

Check and save the settings.

- (1) Check the displayed settings.
- (2) Enter a name for the settings using up to 20 characters.
- (3) Click the [OK] button.



USING SAVED SETTINGS

You can specify the saved favorites through just one click to apply frequently used settings or complicated color settings to your printing.

- 1 Select the machine's printer driver from the print window of the application, and click the [Preferences] button.**



The button that is used to open the printer driver properties window (usually [Property] or [Preferences]) may vary depending on the application.

2

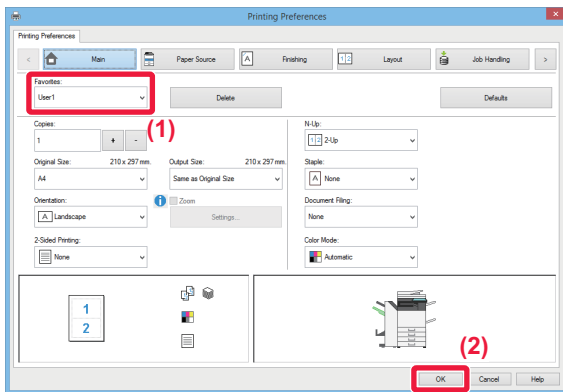

Select favorite settings.

- (1) Select the favorite settings you want to use.**
- (2) Click the [OK] button.**

3

Start printing.

CHANGING THE PRINTER DRIVER DEFAULT SETTINGS

You can change the default settings of the printer driver.

Changes you have made in the printer driver properties window when you execute printing from the application are returned to the default settings specified here when you exit the application.

1

Right-click the [Start] button and select [Control Panel].



In Windows 7, click the [Start] button, select [Devices and Printers], right-click the printer driver icon of the machine, and click [Printer Properties].

2

Click [View devices and printers] in [Hardware and Sound].



3

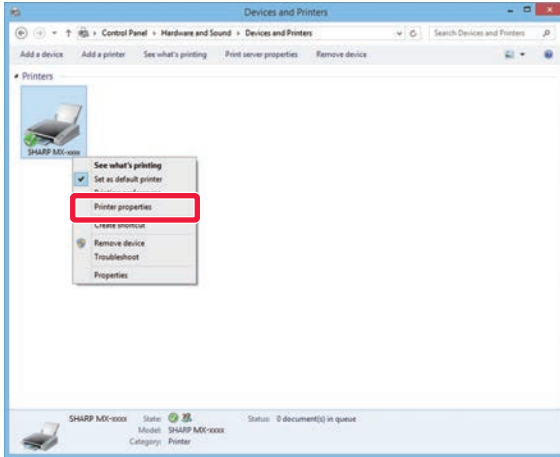

Right-click the printer driver icon of the machine and select [Printer Properties].

4

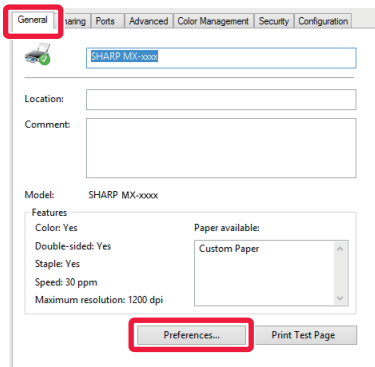

Click the [Preferences] button on the [General] tab.

5

Configure the settings and click the [OK] button.

For explanations of the settings, see printer driver Help.



PRINTING IN A Mac OS ENVIRONMENT

BASIC PRINTING PROCEDURE

The following example explains how to print a document from the standard accessory application "TextEdit" in Mac OS X.



- To install the printer driver and configure settings in a Mac OS environment, see the Software Setup Guide.
- The menu used to execute printing may vary depending on the application.
- On the MX-2630N/MX-3050V/MX-3550V/MX-4050V/MX-5050V/MX-6050V, the PS3 expansion kit is required to use the machine as a printer in a Mac OS environment.

1

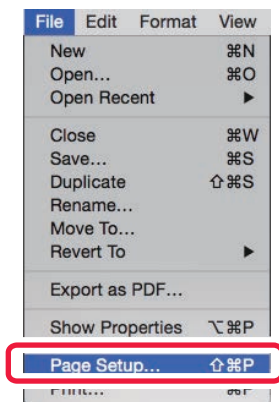

Select [Page Setup] from the [File] menu and select the printer.

If the printer drivers appear as a list, select the name of the printer driver to be used from the list.

2

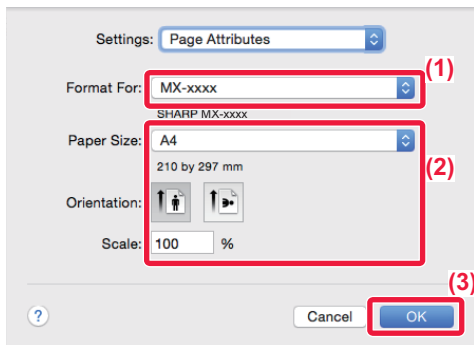

Select paper settings.

(1) Make sure that the correct printer is selected.

(2) Select paper settings.

Paper size, paper orientation, and enlarge/reduce settings can be selected.

(3) Click the [OK] button.

3

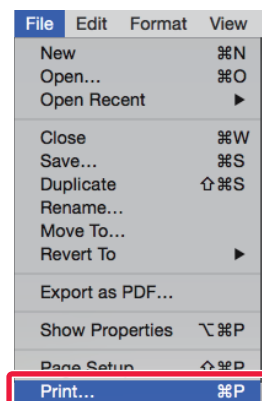

Select [Print] from the [File] menu.



4

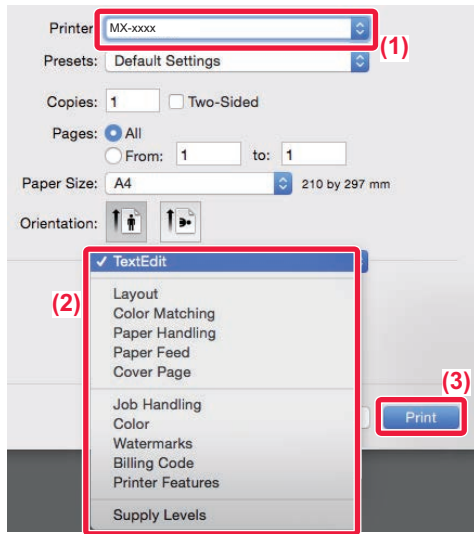

Select print settings.

- (1) Make sure that the correct printer is selected.
- (2) Select an item from the menu and configure the settings as needed.
- (3) Click the [Print] button.

SELECTING THE PAPER

This section explains the [Paper Feed] settings in the print settings window.

• **When [Auto Select] is selected:**

A tray that is set for plain or recycled paper (only plain paper in the factory default setting) of the size specified in "Paper Size" on the page setup screen is automatically selected.

• **When a paper tray is specified:**

The specified tray is used for printing regardless of the "Paper Size" setting on the page setup screen.

For the bypass tray, also specify the paper type. Check that the paper type that is set for the bypass tray of the machine, check that paper of that type is actually loaded into the bypass tray, and then select the appropriate bypass tray (paper type).

• **When a paper type is specified:**

A tray with the specified type of paper and the size specified in "Paper Size" on the page setup screen is used for printing.



Special media such as envelopes can also be placed in the bypass tray.

For the procedure for loading paper in the bypass tray, see "[LOADING PAPER INTO THE BYPASS TRAY \(page 1-78\)](#)".



When [Enable Detected Paper Size in Bypass Tray] (disabled by factory default) or [Enable Selected Paper Type in Bypass Tray] (disabled by factory default), which you can reach by selecting [System Settings] in "Settings (administrator)" → [Printer Settings] → [Condition Settings] → [Bypass Tray Settings] is enabled, printing will not take place if the paper size or paper type specified in the printer driver is different from the paper size or paper type specified in the settings of the bypass tray.



To exclude the bypass tray from the trays that can be selected when [Auto Select] is selected:

In "Settings (administrator)", select [System Settings] → [Printer Settings] → [Condition Settings] → [Bypass Tray Settings] → [Exclude Bypass-Tray from Auto Paper Select].



PRINTING ON ENVELOPES

The bypass tray can be used for envelope printing.



- For the types of paper that can be used in the bypass tray, see "[APPLICABLE PAPER TYPES \(page 1-68\)](#)".
- For the procedure for loading paper in the bypass tray, see "[LOADING PAPER INTO THE BYPASS TRAY \(page 1-78\)](#)".
- For more information on the procedure for loading paper, see "[SELECTING THE PAPER \(page 3-15\)](#)".
- When using media such as envelopes that can be loaded only in a specific orientation, you can rotate the image 180 degrees. For more information, see "[ROTATING THE PRINT IMAGE 180 DEGREES \(ROTATE 180 DEGREES\) \(page 3-36\)](#)".
- It is recommended that you carry out a test print to check the print result before using an envelope.

Select the envelope size in the settings of the application ("Page Setup" in many applications) and then perform the following steps.

1

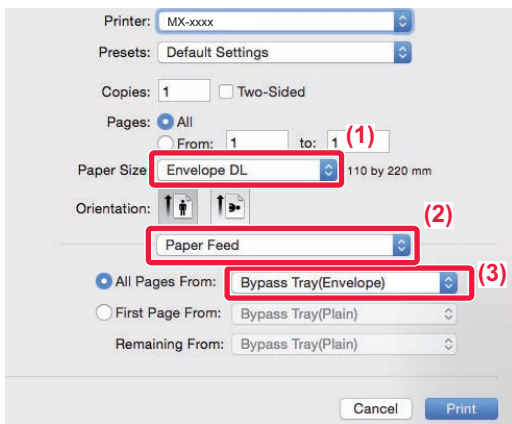

Select print settings.

- (1) Select the envelope size from the "Paper Size" menu.
- (2) Select [Paper Feed].
- (3) Select the [Bypass Tray (Envelope)] from the "All Pages From" menu.



When [Enable Selected Paper Type in Bypass Tray] (disabled by factory default) is enabled in "Settings (administrator)", set the paper type of the bypass tray to [Envelope].



PRINTING WHEN THE USER AUTHENTICATION FUNCTION IS ENABLED

The user information (such as login name and password) that must be entered varies depending on the authentication method being used, so check with the administrator of the machine before printing.



The menu used to execute printing may vary depending on the application.



To prohibit printing by users whose user information is not stored in the machine:
In "Settings (administrator)", select [User Control] → [Default Settings] → [Disable Printing by Invalid User].

1

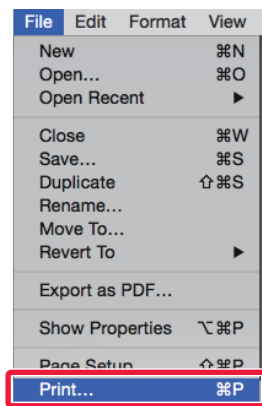

In the application, select [Print] from the [File] menu.



2

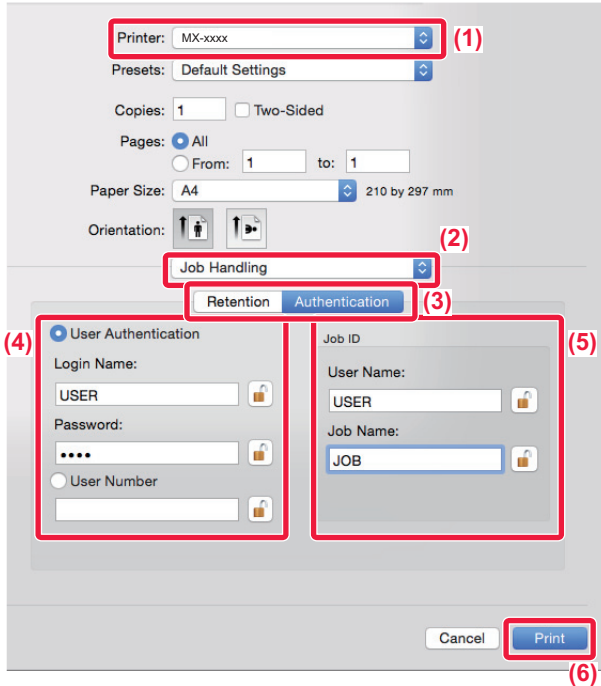

Enter your user information.

(1) **Make sure that the machine's printer name is selected.**

(2) **Select [Job Handling].**

(3) **Click the [Authentication] tab.**

(4) **Enter your user information.**

- When authentication is carried out using the login name/password, enter your login name in "Login Name" and your password (1 to 32 characters) in "Password".
- When authentication is carried out using the user number, enter your user number (5 to 8 digits) in "User Number".

(5) **Enter the user name and job name as necessary.**

- **User Name**
Enter your user name using up to 32 characters. The entered user name will appear on the touch panel of the machine. If you do not enter a user name, your PC login name will appear.
- **Job Name**
Enter a job name using up to 32 characters. The entered job name will appear as a file name on the touch panel of the machine. If you do not enter a job name, the file name set in the application will appear.

(6) **Click the [Print] button.**



You can click the  button after entering your login name and password, or user number, to simplify operation the next time you wish to print based on the same user authentication.



FREQUENTLY USED FUNCTIONS

SELECTING THE COLOR MODE

The following three selections are available for the "Color Mode" (a set of colors used for printing):

Automatic	The machine automatically determines whether each page is color or black and white and prints the page accordingly. Pages with colors other than black and white are printed using Y (Yellow), M (Magenta), C (Cyan) and Bk (Black) toner. Pages that are only black and white are printed using Bk (Black) toner only. This is convenient when printing a document that has both color and black and white pages, however, the printing speed is slower.
Color	All pages are printed in color. Both color data and black and white data are printed using Y (Yellow), M (Magenta), C (Cyan) and Bk (Black) toner.
Black and White	All pages are printed in black and white. Color data such as images or materials for a presentation is printed using black toner only. This mode helps conserve color toner when you do not need to print in color, such as when proofreading or checking the layout of a document.



When "Color Mode" is set to [Automatic]:

Even if the print result is black and white, the following types of print jobs will be counted as 4-color (Y (Yellow), M (Magenta), C (Cyan), and Bk (Black)) print jobs.

When you want such jobs to be counted as black and white jobs, select [Black and White].

- When the data is created as color data.
- When the application treats the data as color data even though the data is black and white.
- When an image is hidden under a black and white image.

Windows

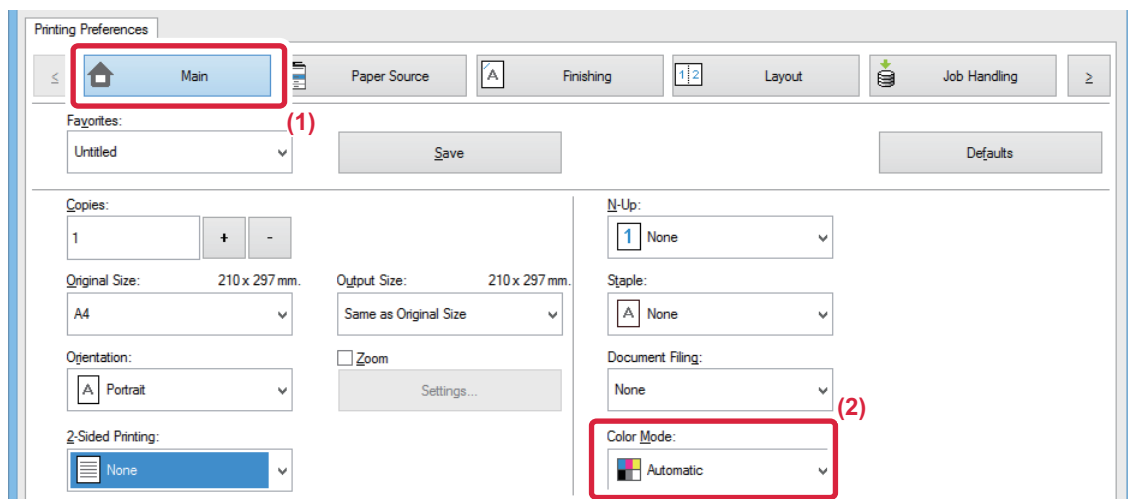

(1) Click the [Main] tab.

(2) Select "Color Mode".



In addition to the [Main] tab, [Color Mode] can also be set on the [Image Quality] tab.



Mac OS

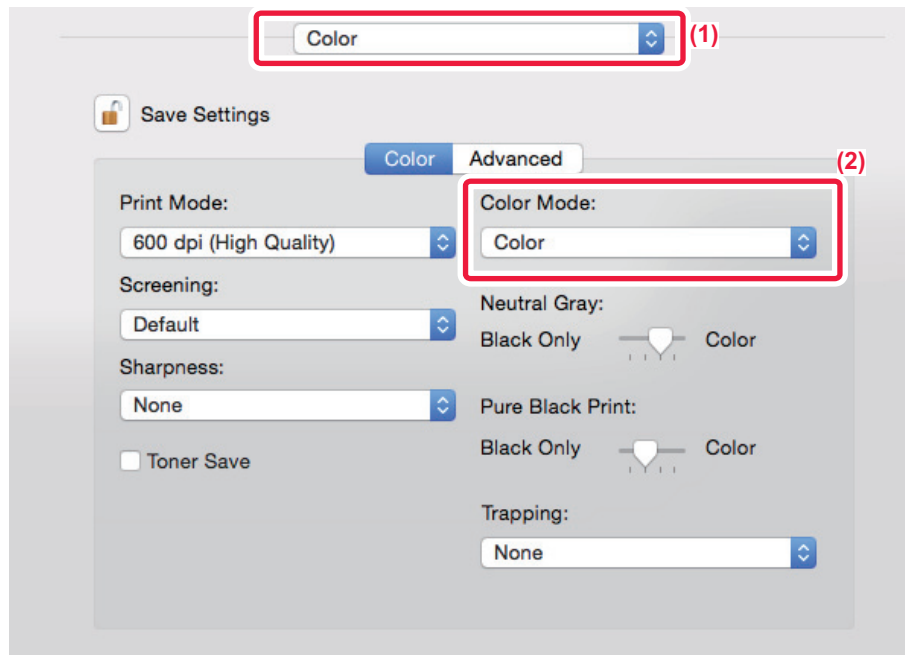

(1) Select [Color].

(2) Select "Color Mode".



SELECTING THE RESOLUTION

The following three selections are available for "Print Mode" (resolution):

600 dpi	This mode is suitable for printing data such as regular text or a table.
600 dpi (High Quality)	The print quality of color photos and text are high.
1200 dpi*	Select this mode to print color photos with higher definition, and to print fine lines clearly.

* This item cannot be used in MX-2630N/MX-3050V/MX-3550V/MX-4050V/MX-5050V/MX-6050V.

Windows

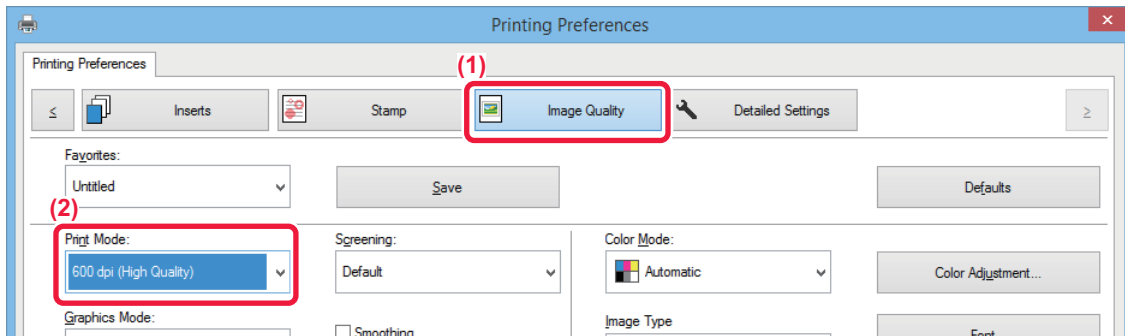

- (1) Click the [Image Quality] tab.
- (2) Select "Print Mode".

Mac OS

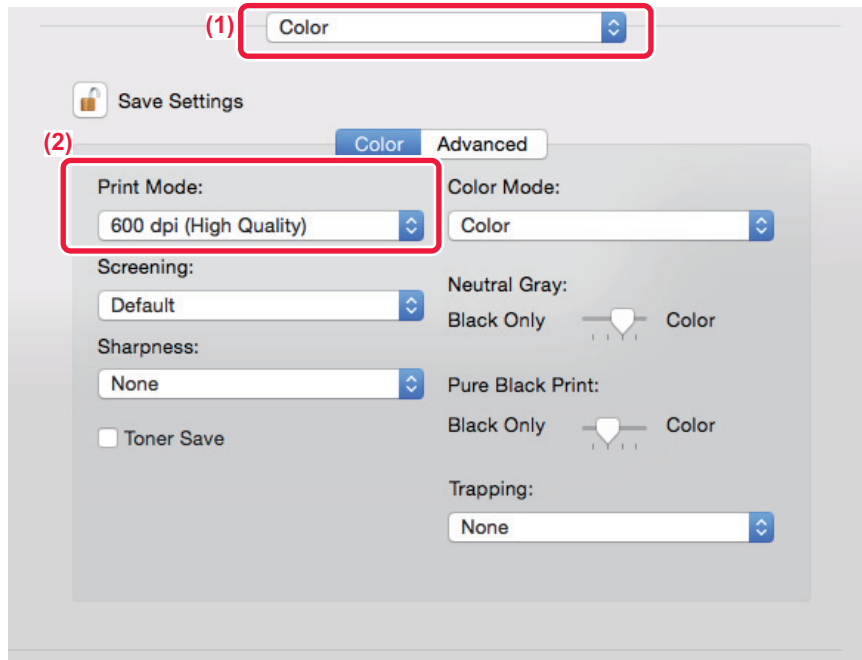





- (1) Select [Color].
- (2) Select "Print Mode".



2-SIDED PRINTING

The machine can print on both sides of the paper. This function is useful for many purposes, and is particularly convenient when you want to create a simple pamphlet. 2-sided printing also helps conserve paper.

Paper orientation	Print results	
Portrait	Long Edge 	Short Edge 
	Short Edge 	Long Edge 
	The pages are printed so that they can be bound at the left or right side.	The pages are printed so that they can be bound at the top.

Windows

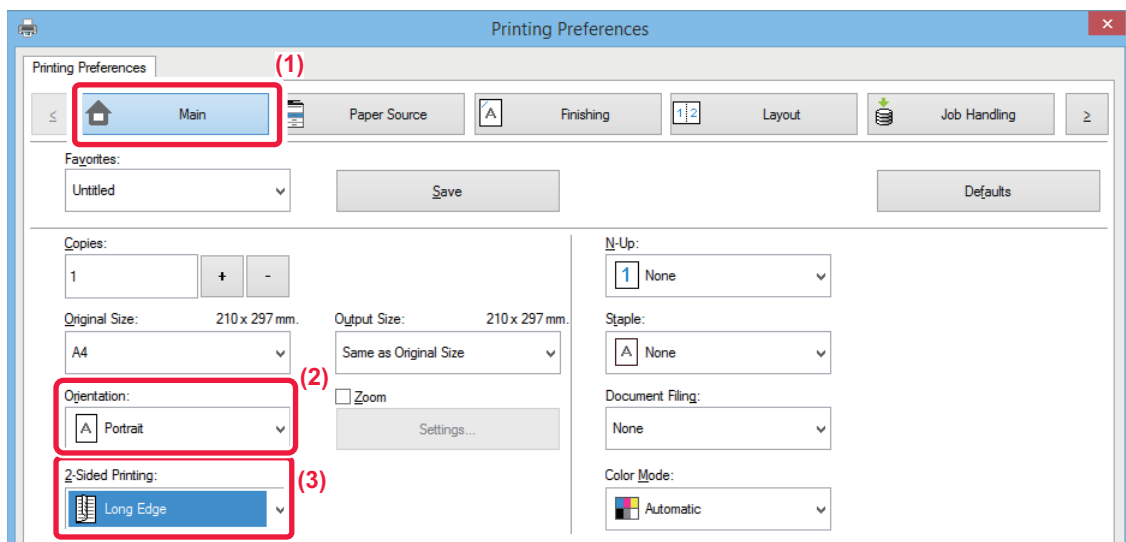

- (1) Click the [Main] tab.
- (2) Select the paper orientation.
- (3) Select [Long Edge] or [Short Edge].



If necessary, you can select the method of implementing 2-sided printing. Click the [Other Settings] button on the [Detailed Settings] tab, and select the mode from "Duplex Style".



Mac OS

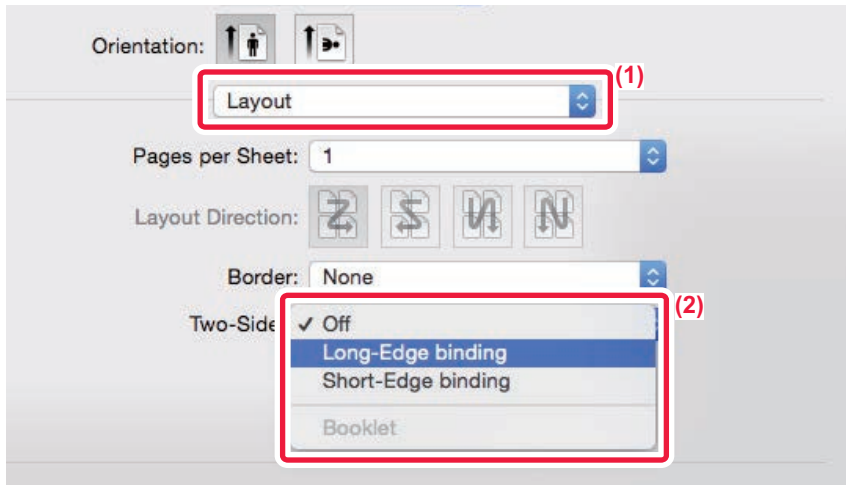

- (1) Select [Layout].
- (2) Select [Long-Edge binding] or [Short-Edge binding].

FITTING THE PRINT IMAGE TO THE PAPER

This function automatically enlarges or reduces the print image to match the size of the paper loaded in the machine. This function is convenient when enlarging a letter or A4 size document to ledger or A3 size to make it easier to view, or when printing a document on paper that is different in size from the original document.

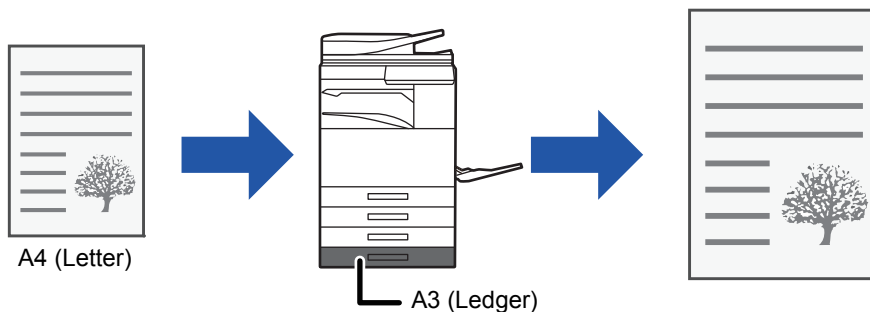

If A0, A1, or A2 size is selected in "Original Size", A4 (or Letter) is automatically selected in "Output Size".

The following example explains how to print a A4 (or letter) size document on ledger (or A3) size paper.



Windows

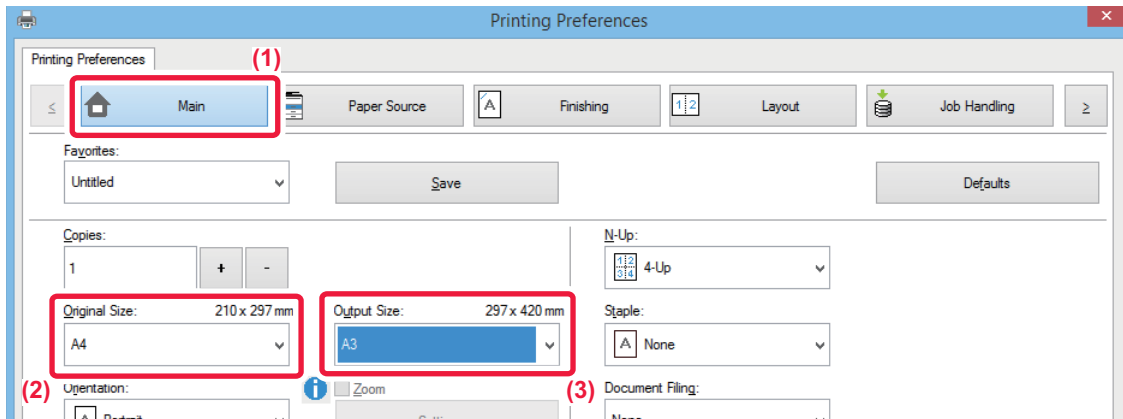

- (1) Click the [Main] tab.
- (2) Select the original size from [Original Size] (for example: A4).
- (3) Select the actual paper size to be used for printing from [Output Size] (for example: A3).
If the output size is larger than the original size, the printed image will be automatically enlarged.

Mac OS

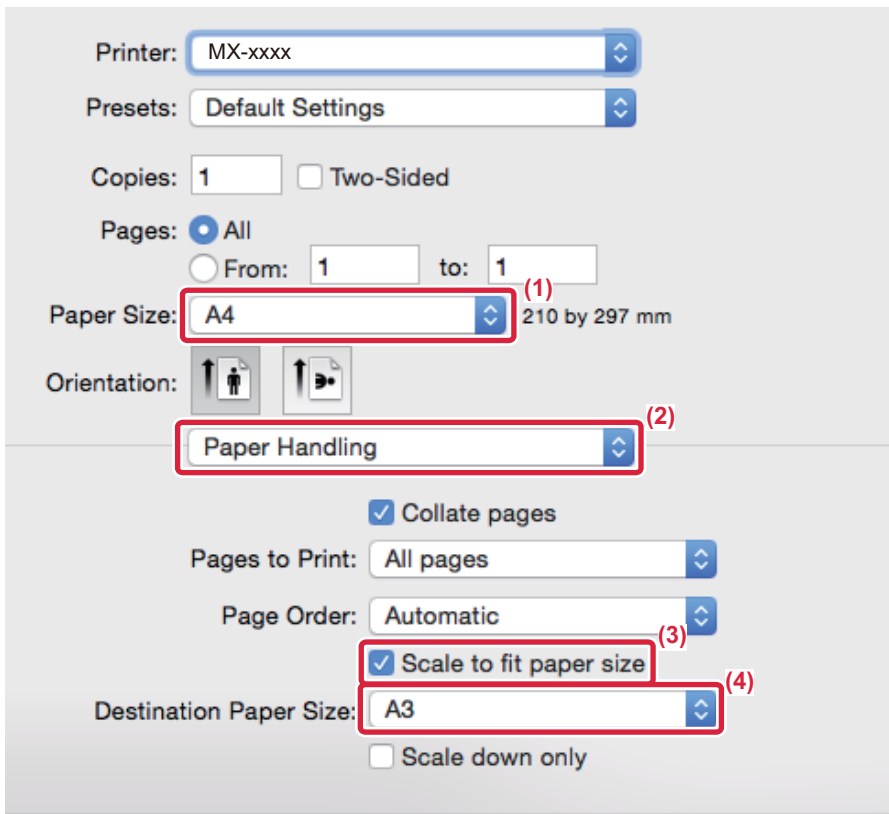

- (1) Check the paper size for the print image (for example: A4).
- (2) Select [Paper Handling].
- (3) Select [Scale to fit paper size].
- (4) Select the actual paper size to be used for printing (for example: A3).



PRINTING MULTIPLE PAGES ON ONE PAGE

This function reduces the print image and prints multiple pages on a single sheet of paper. You can print only the first page in the original size and print multiple reduced pages on the subsequent sheets.

For example, when [2-Up] (2 pages per sheet) or [4-Up] (4 pages per sheet) is selected, the following print results will be obtained, depending on the selected page order.

This is convenient when you want to print multiple images such as photos on a single sheet of paper, and when you want to conserve paper. When used in combination with 2-sided printing, this function saves more paper.

N-Up (Pages per sheet)	Print results		
	Left to Right	Right to Left	Top To Bottom (When the print orientation is landscape)
2-Up (2 pages per sheet)			

N-Up (Pages per sheet)	Right, and Down	Down, and Right	Left, and Down	Down, and Left
4-Up (4 pages per sheet)				



- [N-Up] that can be set on the [Layout] tab can also be set on the [Main] tab. ("Order" can only be set in the [Layout] tab.)
- Note the following when printing multiple pages on one sheet:
 - The page orders for 6-Up, 8-Up, 9-Up, and 16-Up are the same as for 4-Up.
 - In a Windows environment, the page order can be viewed in the print image in the printer driver properties window.
 - In a Mac OS environment, the page orders are displayed as selections.
 - In a Mac OS environment, the number of pages that can be printed on a single sheet is 2, 4, 6, 9, or 16. Printing 8 pages on one sheet is not supported.
- For information on the "Repeat" function, see "[PRINT THE SAME IMAGE IN TILE PATTERN \(REPEAT PRINT\)](#) (page 3-68)".



The function for printing only the first page normally can only be used in the PCL6 printer driver.



Windows

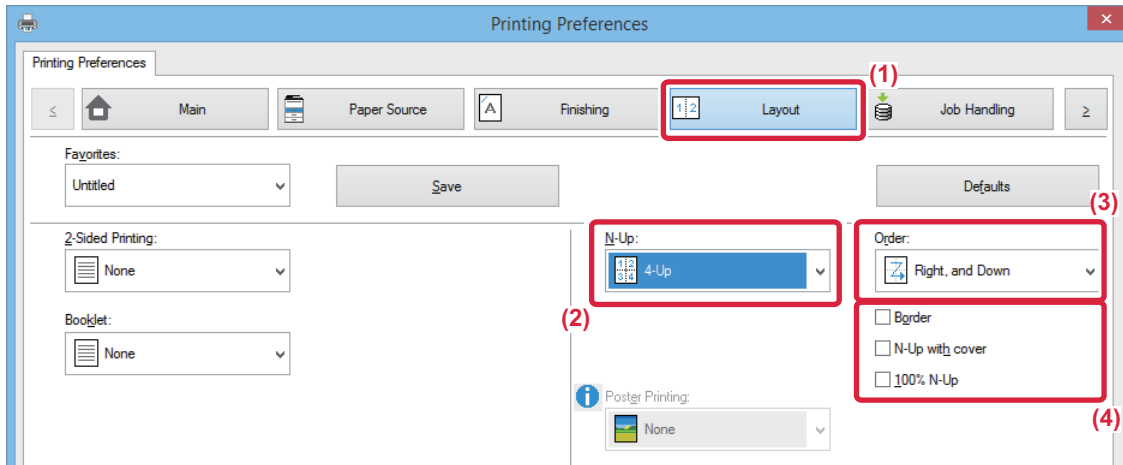

- (1) Click the [Layout] tab.
- (2) Select the number of pages per sheet.
- (3) Select the order of the pages.
- (4) If you wish to print borderlines, click the [Border] checkbox so that the checkmark appears.
 - To print the first page normally (as a cover), select the [N-Up with cover] checkbox (). (PCL6 only)
 - When [100% N-Up] is selected () for jobs such as N-Up copying of two A4 size pages onto one A3 sheet, the pages will be printed at the full size of the original. If you select [Border] at this time, only the border will be printed.

Mac OS

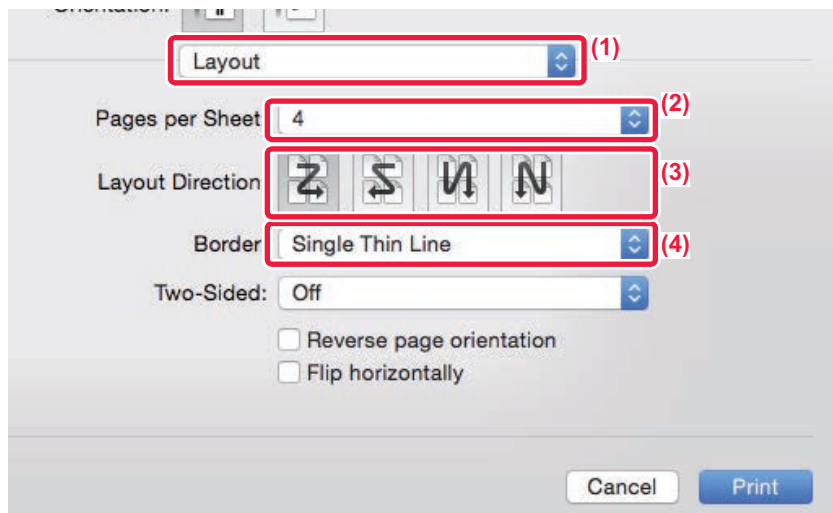

- (1) Select [Layout].
- (2) Select the number of pages per sheet.
- (3) Select the order of the pages.
- (4) If you wish to print borderlines, select the desired type of borderline.



PRINTING WHILE SKIPPING BLANK PAGES

If the scanned original contains blank pages, the blank pages are skipped during printing. The machine detects blank pages and does not print them. This eliminates unnecessary printing without you having to check for blank pages before printing.

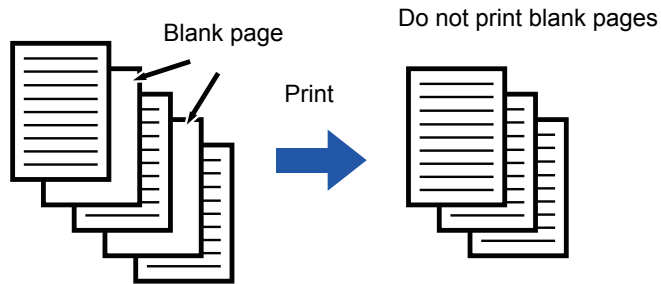

This function is available in a Windows environment.



- Depending on the state of the original, some pages that are not blank may be detected as blank pages and thus not being printed, or some pages that are blank may not be detected as blank and thus printed.
- In N-Up Print, blank pages are not excluded and are printed.

Windows

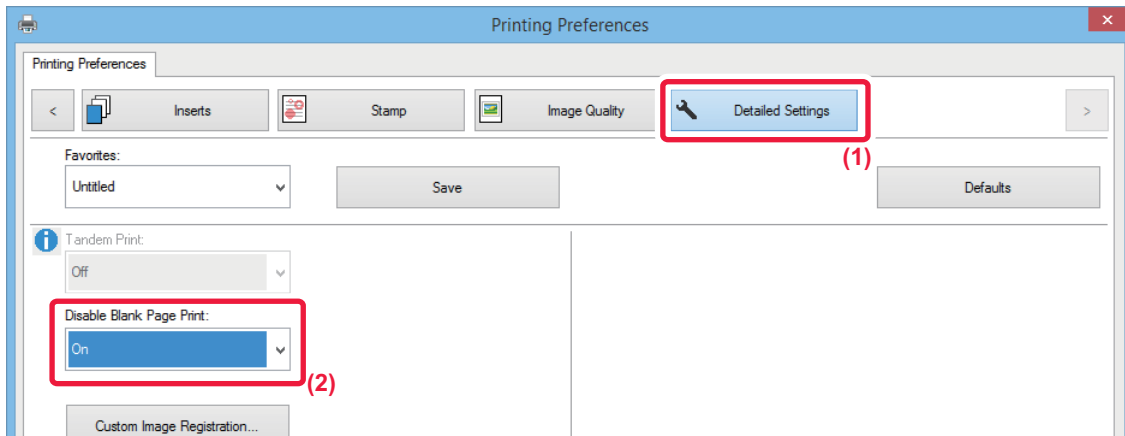

- (1) Click the [Detailed Settings] tab.
- (2) Select [On] in [Disable Blank Page Print].



STAPLING OUTPUT/PUNCHING HOLES IN OUTPUT

Staple function

The staple function staples the output. To create materials with more sophisticated appearance, the staple function can be used in combination with 2-sided printing.

This function saves considerable time when preparing handouts for a meeting or other stapled materials.

The stapling positions and the number of staples can be selected to obtain the following stapling results.

Staple	Left	Right	Top
1 Staple*			
2 Staples			
Stapleless			

* The staple orientation (" | " or " — ") varies depending on the size and orientation of the paper.

Punch function

The punch function punches holes in the output. The punch hole positions are set by selecting the binding edge.

Left	Right	Top



- An inner finisher, finisher, finisher (large stacker), saddle stitch finisher or saddle stitch finisher (large stacker) is required to use the staple function.
- An inner finisher, finisher (large stacker) or saddle stitch finisher (large stacker) is required to use the stapleless staple function.
- To use the punch function, installing a punch module in the inner finisher, finisher, finisher (large stacker), saddle stitch finisher or saddle stitch finisher (large stacker).
- The number of holes that can be punched and the spacing between the holes varies depending on the installed punch module.
- For the maximum number of sheets that can be stapled, see "SPECIFICATIONS" in the Start Guide.
- The maximum number of sheets that can be stapled at once includes any covers and/or inserts that are inserted.
- For information on the saddle stitch function, see "[CREATE A PAMPHLET \(BOOKLET/SADDLE STITCH\) \(page 3-30\)](#)".



- The staple and offset (shifting the position of the paper that is output for each job) functions cannot be used simultaneously.
- When the finisher is disabled in the machine's settings, the staple function and punch function cannot be used.
- When the staple function or the punch function is disabled in the machine's settings, stapling or punching is not possible.



Windows

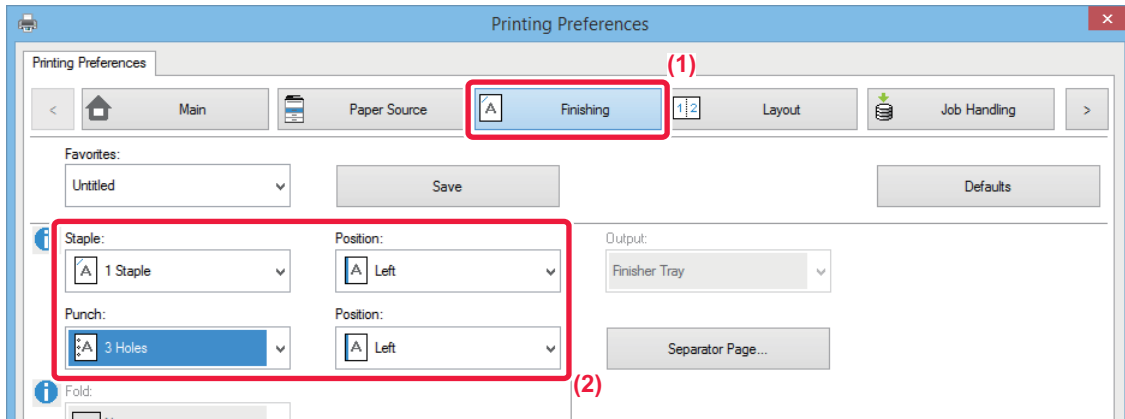

(1) Click the [Finishing] tab.

(2) Select the staple function or the punch function.

- For the staple function, select the number of staples in the "Staple" menu and the staple position in the "Position" menu.
- For the punch function, select the type of punch in the "Punch" menu and the punch position in the "Position" menu.



In addition to the [Finishing] tab, [Staple] can also be set on the [Main] tab.

Mac OS

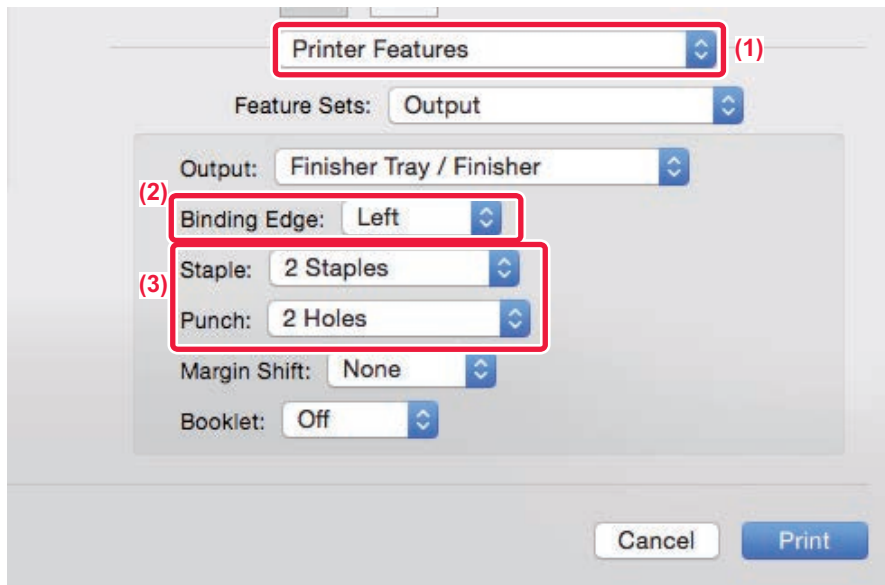

(1) Select [Printer Features].

(2) Select "Binding Edge".

(3) Select the staple function or the punch function.

- For the staple function, select the number of staples in the "Staple" menu.
- For the punch function, select the type of punch in the "Punch" menu.



CONVENIENT PRINTING FUNCTIONS

CONVENIENT FUNCTIONS FOR CREATING PAMPHLETS AND POSTERS

CREATE A PAMPHLET (BOOKLET/SADDLE STITCH)

The pamphlet function prints on the front and back of each sheet of paper so that the sheets can be folded and bound to create a pamphlet.

If a saddle finisher is installed and if "Booklet" and "Staple" are selected, this function automatically folds and outputs the copies. This is convenient when you wish to compile printed output into a pamphlet.

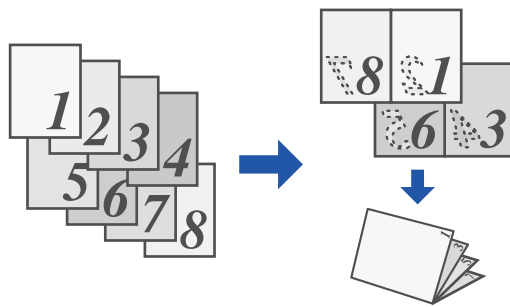

Windows

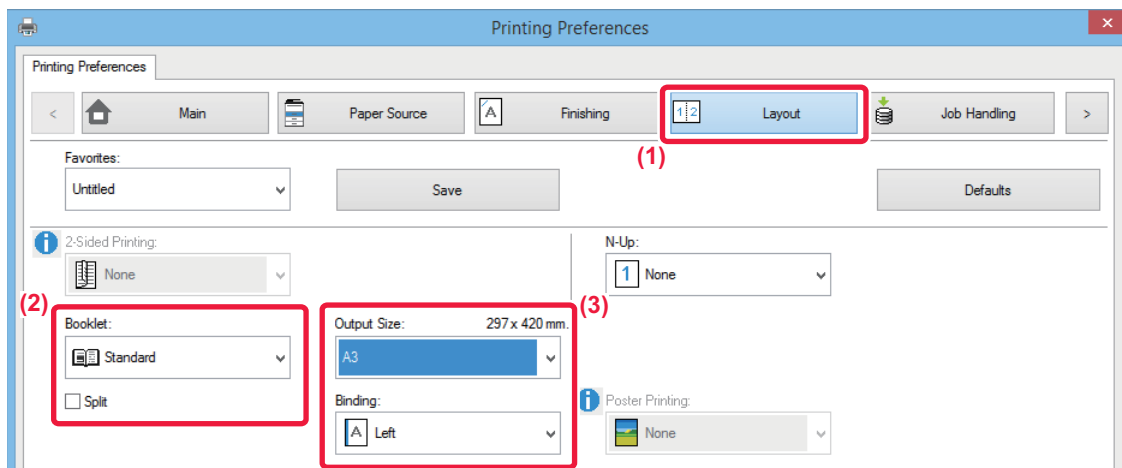

- (1) Click the [Layout] tab.
- (2) Select [Standard] or [Full Image] in "Booklet".
 - When [Standard] is selected, the printed image will be enlarged or reduced to fit the paper selected in "Output Size".
 - When [Full Image] is selected, the printed image will be enlarged or reduced to fit the size selected in "Fit To Paper Size". By selecting a paper size that is larger than the print image, you can cut off the edges of the paper after making the booklet to create a booklet with no margins.
 - When the number of output pages will exceed the number of sheets that can be stapled, you can select the [Split] checkbox () to divide the output into multiple sub-booklets that can each be stapled. When stacked, the sub-booklets will have the same page order as the original pages.
- (3) Select the specified output size and the binding edge.
 - When [Standard] is selected, select the output paper size.
 - When [Full Image] is selected, select the size to which you want to enlarge or reduce the print image in [Fit To Paper Size], and select the paper size you want to use for printing in "Output Size".



If a saddle stitch finisher is installed

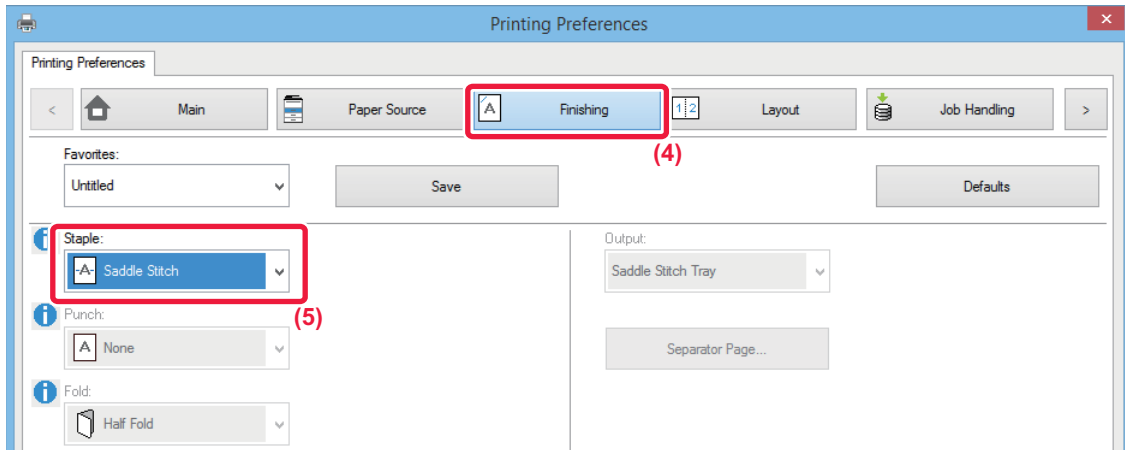

- (4) Click the [Finishing] tab.
- (5) Select [Saddle Stitch] from "Staple".



When a saddle finisher (large capacity) is installed and the job is not output correctly with [Saddle Stitch], select [Saddle Stitch (Reverse)].

Mac OS

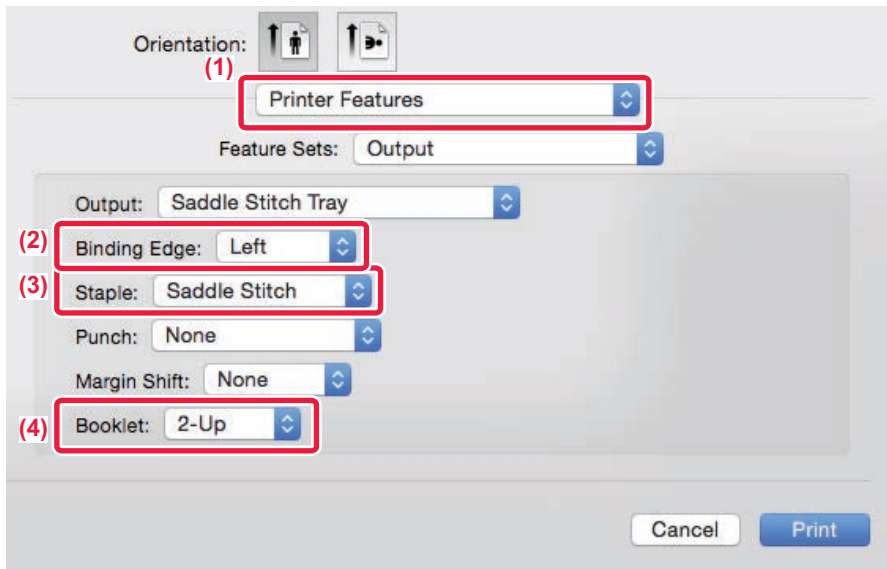

- (1) Select [Printer Features].
- (2) Select "Binding Edge".
- (3) Select [Saddle Stitch].
- (4) Select [Booklet] or [2-Up].



PRINTING WITH MARGIN SHIFT SETTING (MARGIN)

This function shifts the print image to increase the margin at the left, the right, or the top of the paper. If a finisher or saddle finisher is installed, the staple and punch functions of the machine can also be used together. This is convenient when you wish to staple or punch the output but the binding area overlaps the text.

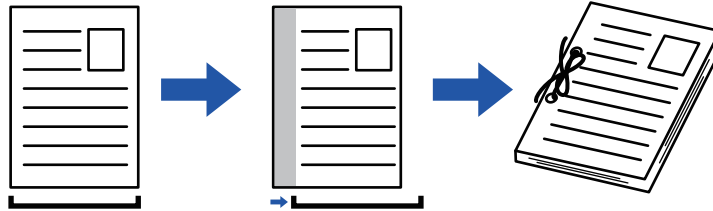

By shifting the image, the part of the image that is outside the print area will not be printed.

Windows

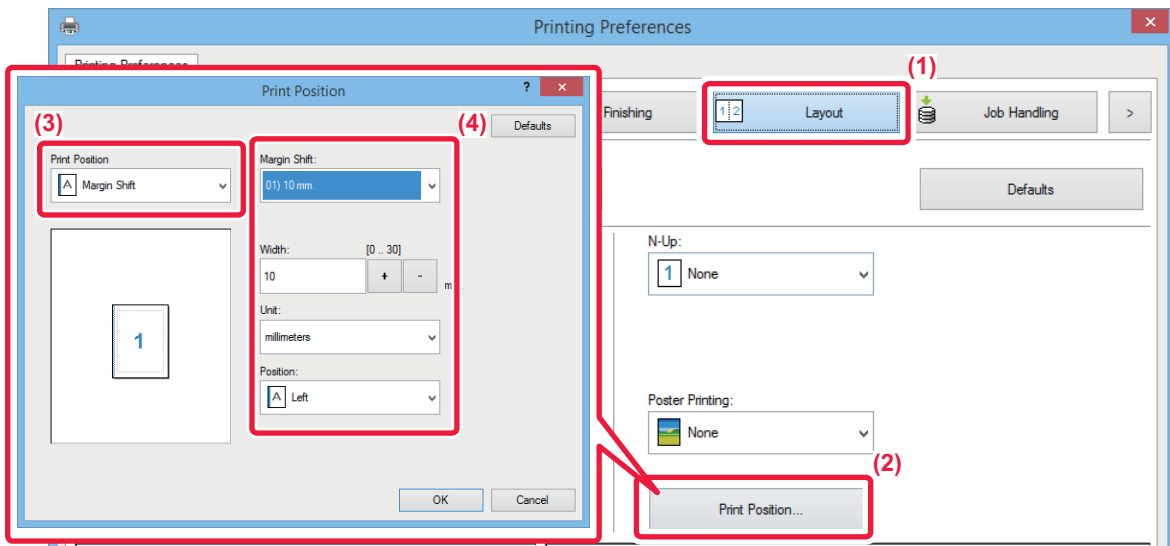

- (1) Click the [Layout] tab.
- (2) Click the [Print Position] button.
- (3) Select [Margin Shift].
- (4) Select the shift width.

Select from the "Margin Shift" menu. If you wish to configure another numeric setting, select the setting and click buttons or directly enter the number.



Mac OS

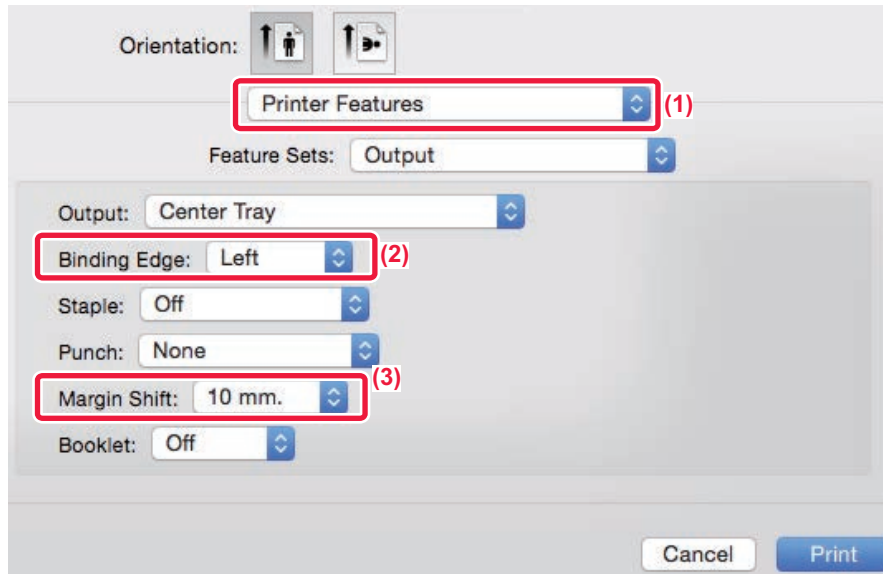

- (1) Select [Printer Features].
- (2) Select "Binding Edge".
- (3) Select "Margin Shift".



CREATE A LARGE POSTER (POSTER PRINTING)

One page of print data is enlarged and printed using multiple sheets of paper (4 sheets (2 x 2), 9 sheets (3 x 3) or 16 sheets (4 x 4)). The sheets can then be attached together to create a large poster.

To enable precise alignment of the edges of the sheets during attachment, borderlines can be printed or overlapping edges can be created (overlap function).

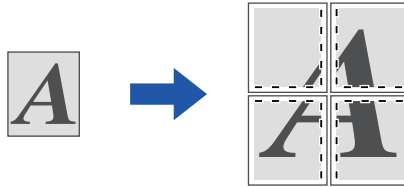

This function is available in a Windows environment.

Windows

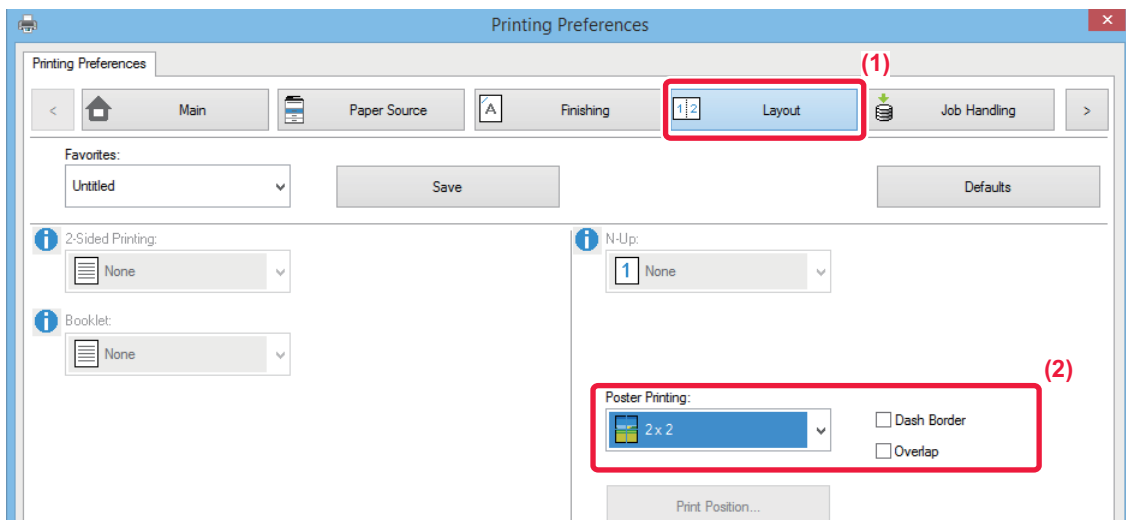

(1) Click the [Layout] tab.

(2) Select the number of sheets to be used in "Poster Printing".

If you wish to print borderlines and/or use the overlap function, click the corresponding checkboxes so that the appears.



FUNCTIONS TO ADJUST THE SIZE AND ORIENTATION OF THE IMAGE

ADJUST PRINT POSITION ON ODD AND EVEN PAGES SEPARATELY (PRINT POSITION)

This function sets different print positions (margins) separately for odd and even pages and prints the pages.



This function is available in a Windows environment.

Windows

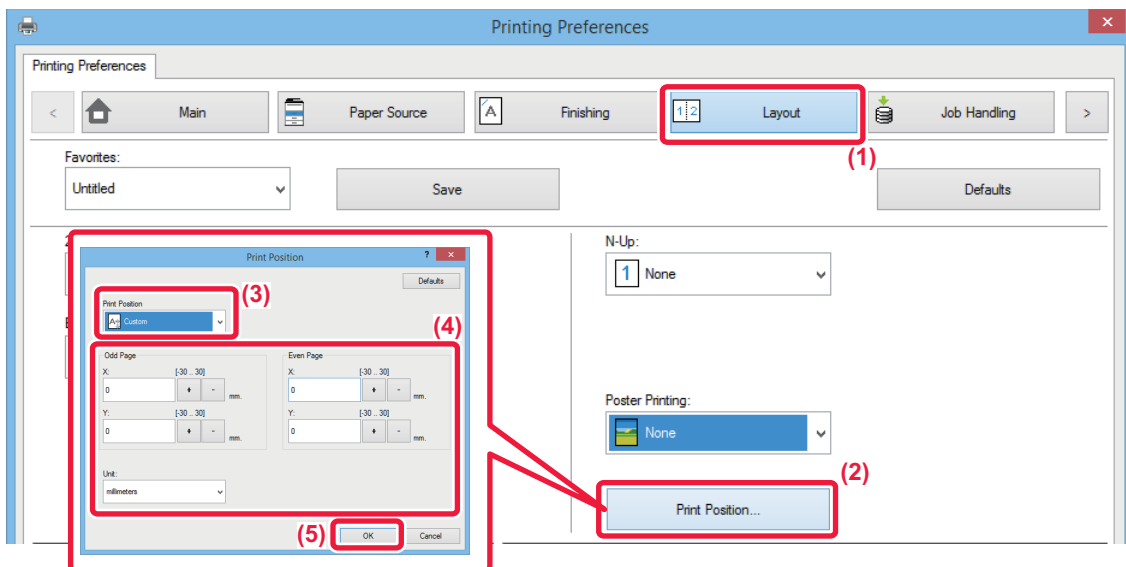

- (1) Click the [Layout] tab.
- (2) Click the [Print Position] button.
- (3) Select [Custom].
- (4) Set the amount of shifting of the print position for odd-numbered pages and even-numbered pages.
- (5) Click the [OK] button.



ROTATING THE PRINT IMAGE 180 DEGREES (ROTATE 180 DEGREES)

This feature rotates the image 180 degrees so that it can be printed correctly on paper that can be loaded in only one orientation (such as envelopes or paper with punch holes).

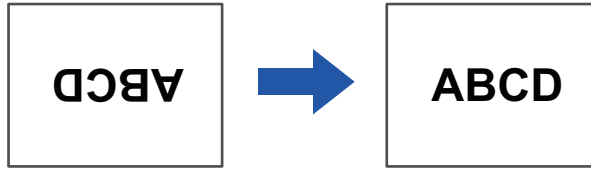

Windows

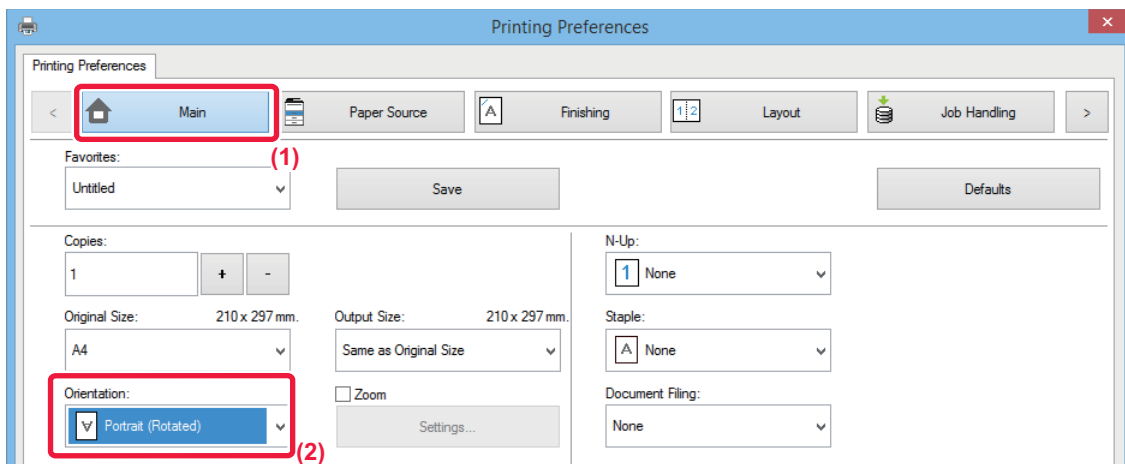

- (1) Click the [Main] tab.
- (2) Select [Portrait (Rotated)] or [Landscape (Rotated)] in "Orientation".

Mac OS

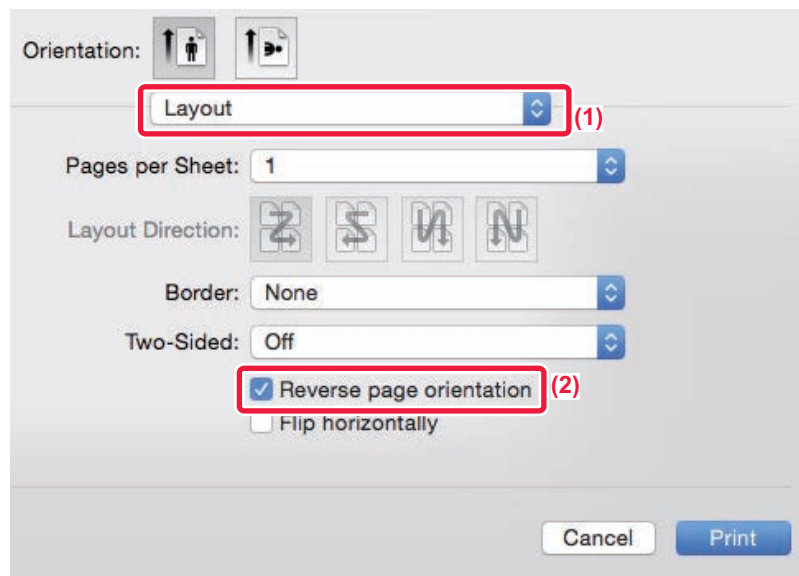

- (1) Select [Layout]
- (2) Select the [Reverse page orientation] checkbox so that appears.



ENLARGING/REDUCING THE PRINT IMAGE (ZOOM SETTING/ENLARGE OR REDUCE)

This function enlarges or reduces the image to a selected percentage.

This allows you to enlarge a small image or add margins to the paper by slightly reducing an image.

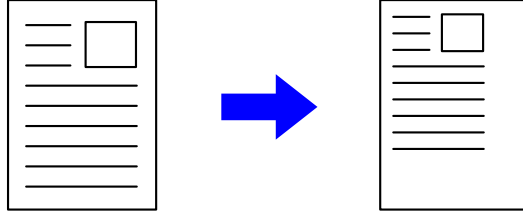

When using the PS printer driver (Windows), you can set the width and length percentages separately to change the proportions of the image.

Windows

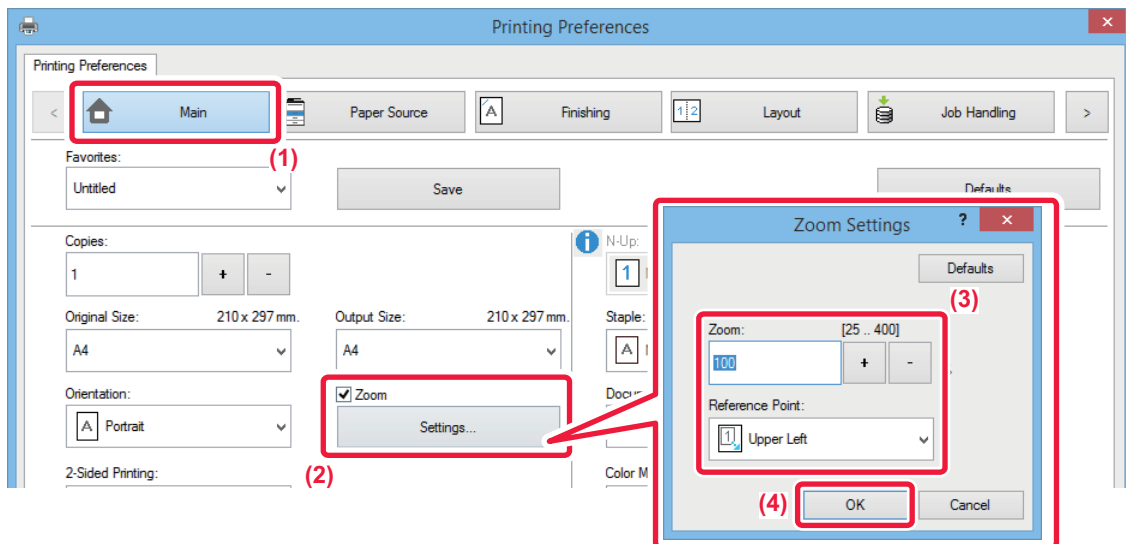

(1) Click the [Main] tab.

(2) Click the [Zoom] checkbox so that appears, and click the [Settings] button.

(3) Enter the percentage.

By clicking the button, you can specify the value in increments of 1%. In addition, select [Upper Left] or [Center] for the base point on the paper.

(4) Click the [OK] button.



Mac OS

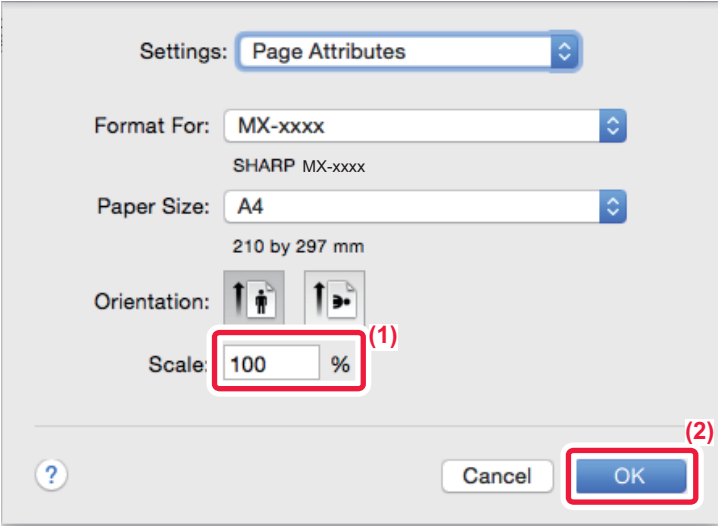

- (1) Select [Page Setup] from the [File] menu and enter the ratio (%).
- (2) Click the [OK] button.



ADJUST THE LINE THICKNESS (WIDTH)

Adjusting line widths used in data such as CAD

This function increases the thickness of the entire line when the print lines are not clear in CAD or other special applications.

When the data includes lines of varying widths, you can print all lines at the minimum width as necessary.

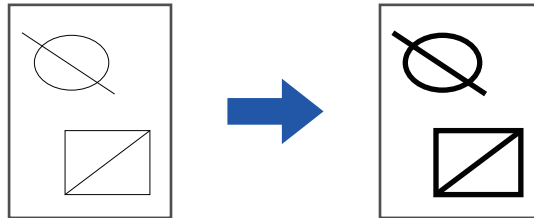

- This function is available in a Windows environment.
- This function can be used when the PCL6 printer driver is used.
- When printing from an application that processes lines as raster graphics, line widths cannot be adjusted.

Windows

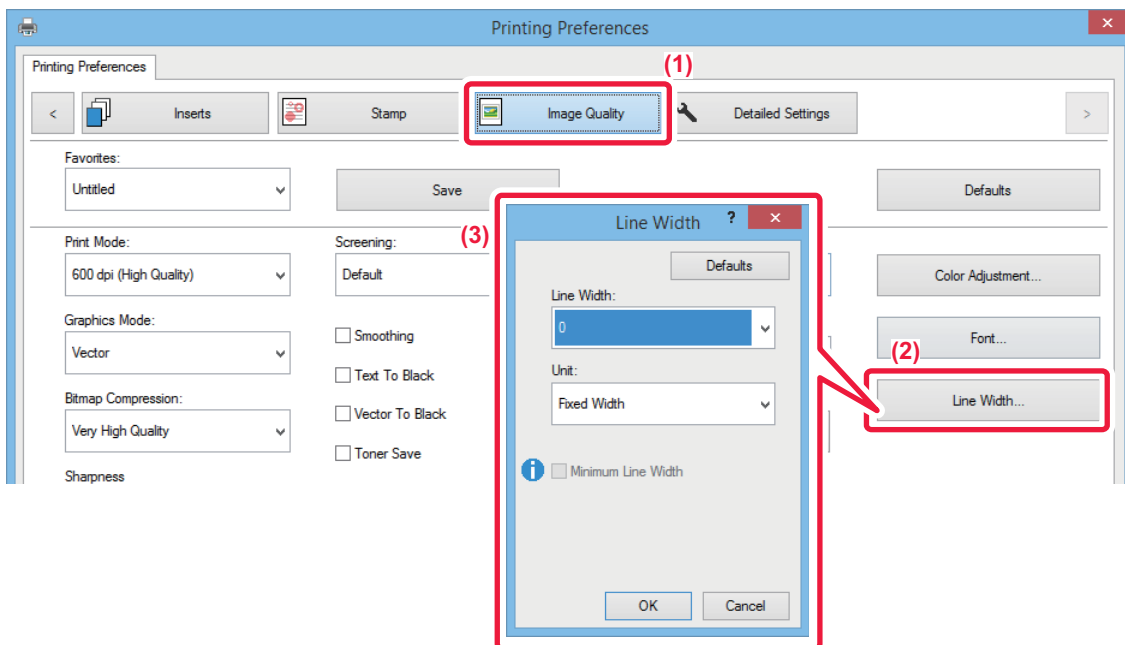

- (1) Click the [Image Quality] tab.
- (2) Click the [Line Width] button.
- (3) Set the line thickness and click the [OK] button.



- The units of line-width adjustment can be set to "Fixed Width" or "Ratio". Select from the "Unit" menu.
- To print all line data in the minimum line width, click the [Minimum Line Width] checkbox.



Thickening fine lines in Excel

When fine border lines in Excel do not print correctly, you can make the lines thicker.



- This function is available in a Windows environment.
- This function can be used when the PCL6 printer driver is used.
- Normally this setting is not necessary.

Windows

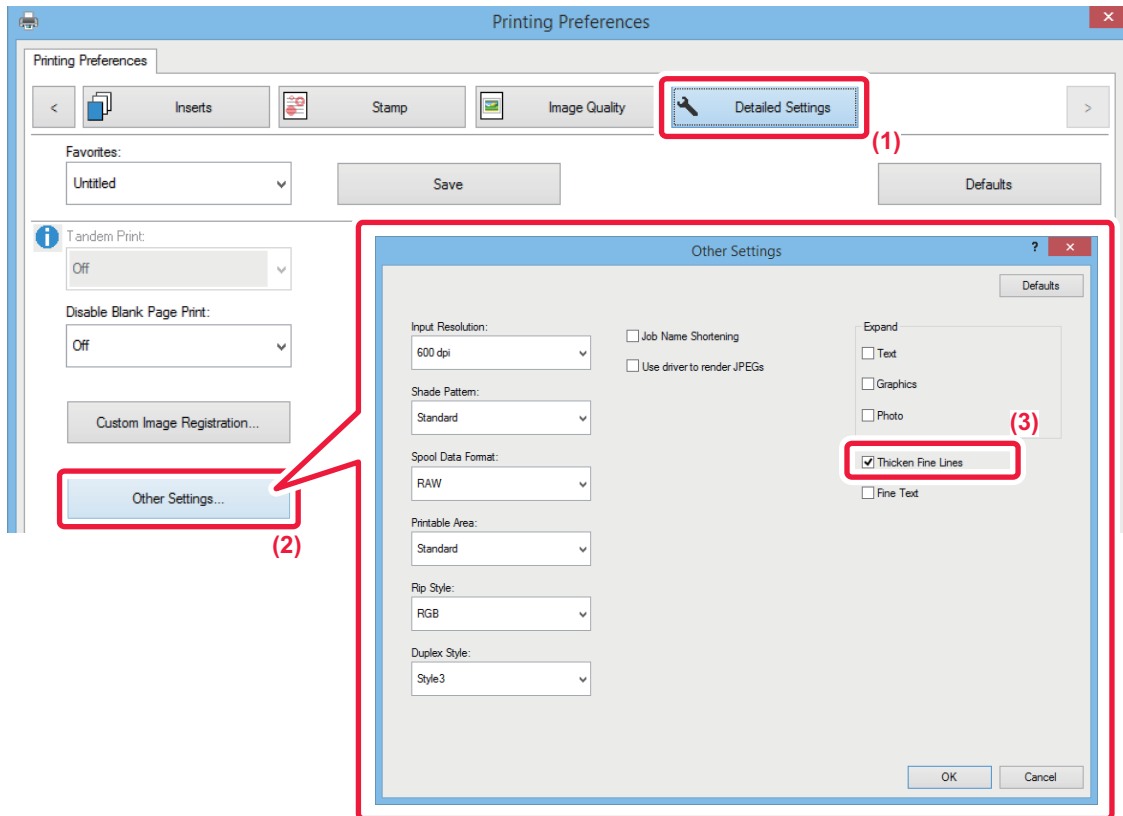

- (1) Click the [Detailed Settings] tab.
- (2) Click the [Other Settings] button.
- (3) Select the [Thicken Fine Lines] checkbox ().



PRINT A MIRROR-IMAGE (MIRROR-IMAGE REVERSE/VISUAL EFFECTS)

The image is reversed to create a mirror image. This function is conveniently used to print a design for a woodblock print or other printing medium.

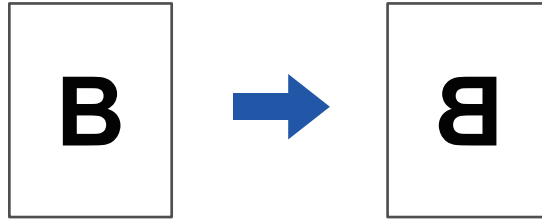

In a Windows environment, this function is only available when using the PS printer driver.

Windows

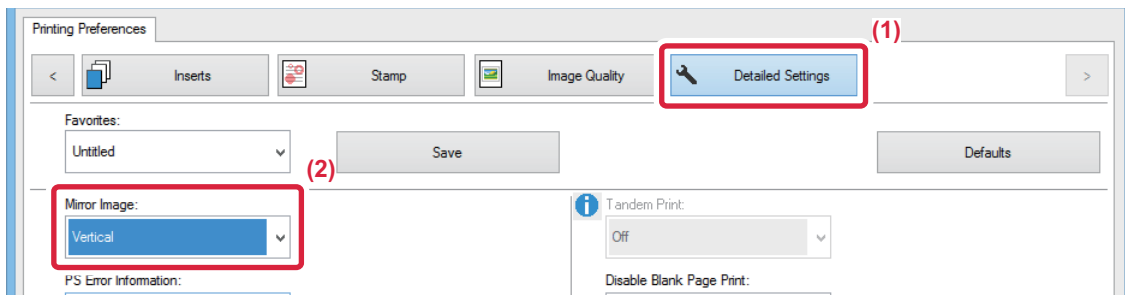

- (1) Click the [Detailed Settings] tab.
- (2) If you wish to reverse the image horizontally, select [Horizontal]. If you wish to reverse the image vertically, select [Vertical].

Mac OS

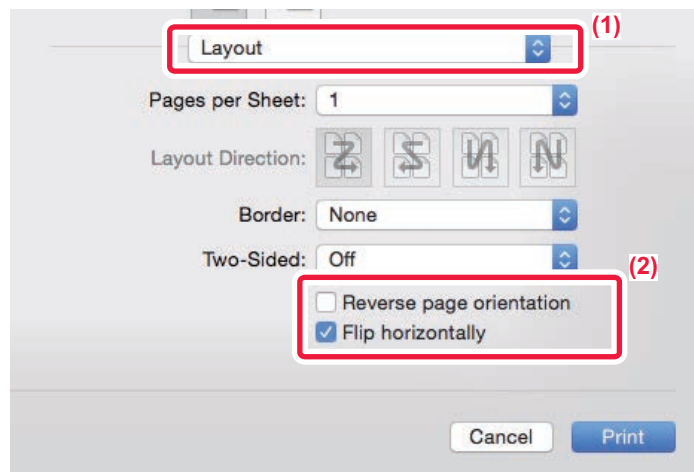

- (1) Select [Layout].
- (2) Select the [Flip horizontally] checkbox ().



COLOR MODE ADJUSTING FUNCTION

ADJUST THE BRIGHTNESS AND CONTRAST OF THE IMAGE (COLOR ADJUSTMENT/RGB ADJUSTMENT)

This function adjusts the brightness and contrast in the print settings when a photo or other image is printed. This function makes simple corrections even if image editing software is not installed on your computer.

Windows

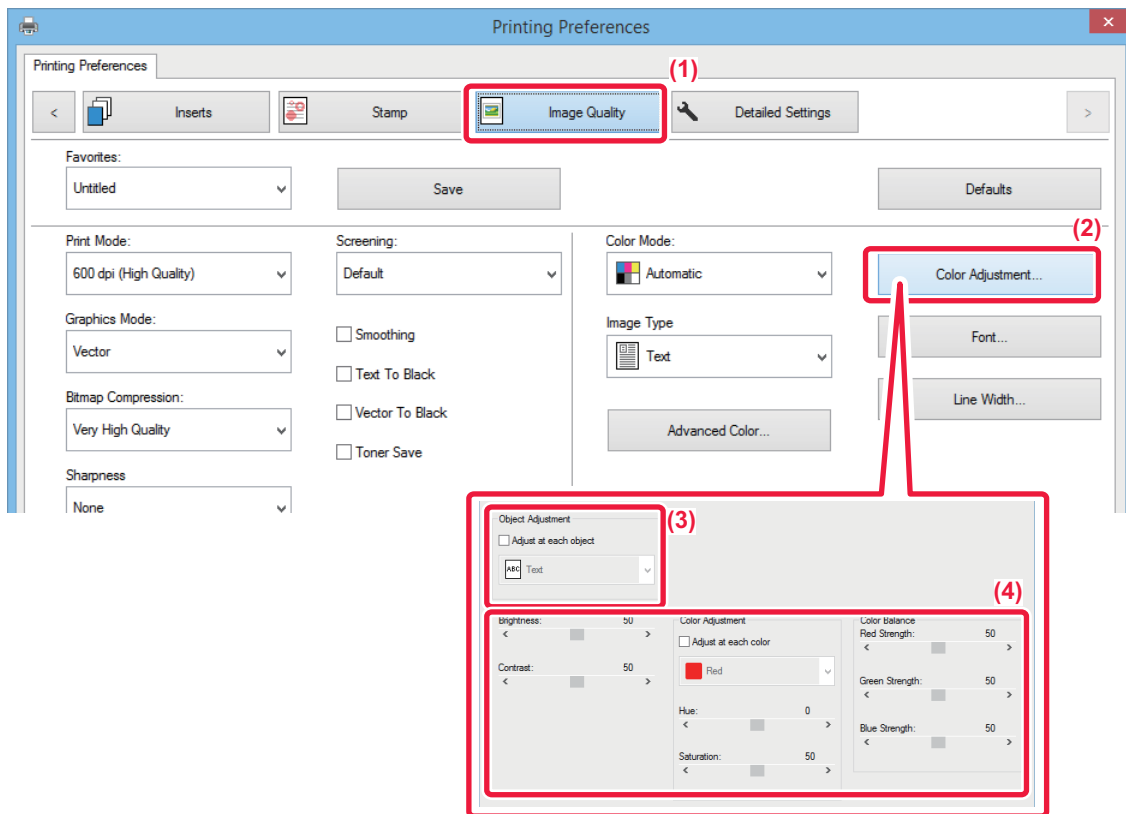

- (1) Click the [Image Quality] tab.
- (2) Click the [Color Adjustment] button.
When using the PS printer driver, click the [RGB Adjustment] button. Proceed to step (4).
- (3) To adjust objects (text, graphics, photos) individually, select the [Adjust at each object] checkbox () and select the object.
- (4) Drag the slide bar or click buttons to adjust the image.



Mac OS

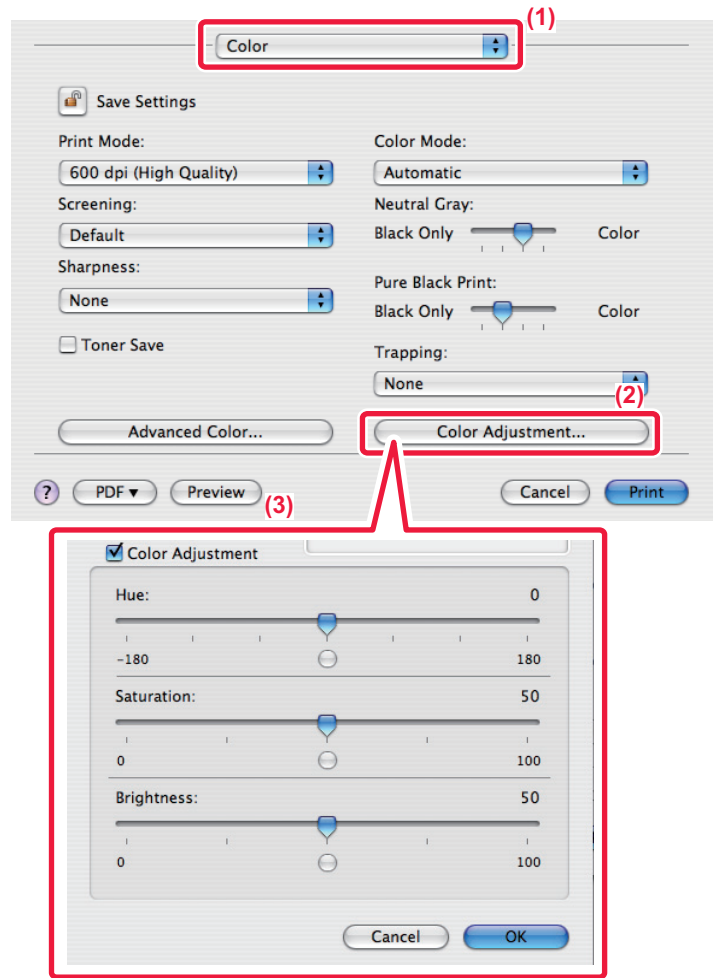

- (1) Select [Color].
- (2) Click the [Color Adjustment] button.
- (3) Select the [Color Adjustment] checkbox () and adjust the color settings.
Adjust each setting value by dragging the slide bar  .



PRINTING FAINT TEXT AND LINES IN BLACK (TEXT TO BLACK/VECTOR TO BLACK)

When printing a color image in grayscale, text and lines that are drawn in faint colors are printed in black. This function allows you to bring out color text and lines that are faint and difficult to see when printed in grayscale.

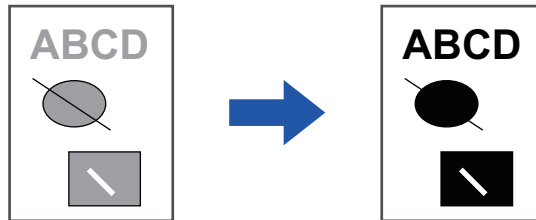

- Raster data such as bitmap images cannot be adjusted.
- This function is available in a Windows environment.

Windows

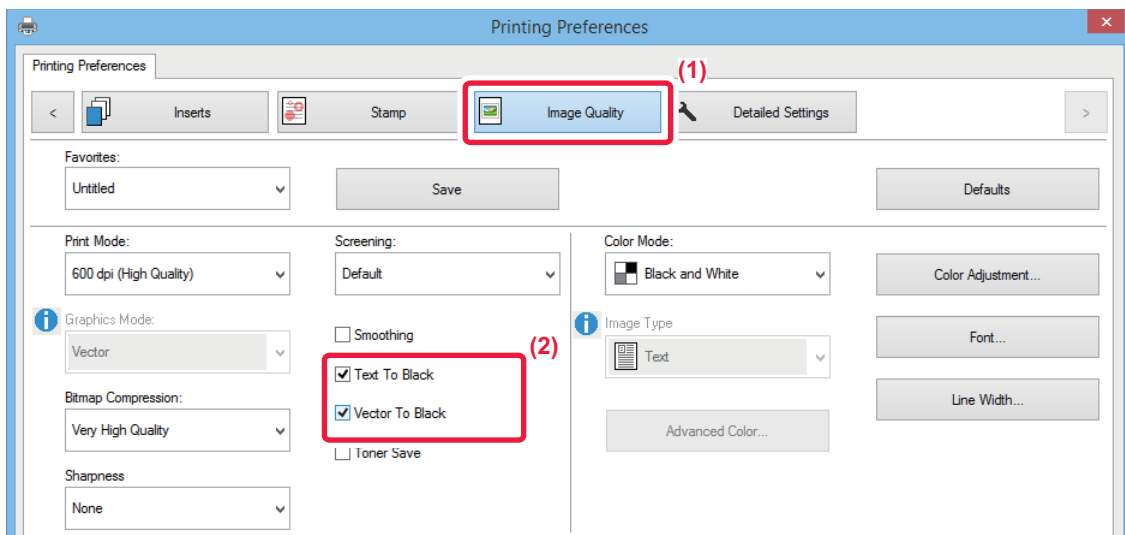

- (1) Click the [Image Quality] tab.
- (2) Select the [Text To Black] checkbox and/or the [Vector To Black] checkbox so that appears.
 - When [Text To Black] is selected, all text other than white text is printed in black.
 - When [Vector To Black] is selected, all vector graphics other than white lines and areas are printed in black.



SELECTING COLOR SETTINGS TO MATCH THE IMAGE TYPE (ADVANCED COLOR SETTINGS)

Preset color settings are available in the machine's printer driver for various uses. These enable printing using the most suitable color settings for the color image type.

Advanced color settings, such as the color management settings and the screening setting for adjusting the color tone expression, are also available for meeting the needs of color image printing.

The following color management settings are available.

Windows ICM	Color management method in a Windows environment
ColorSync	Color management method in a Mac OS environment
Source Profile	Select a source color profile of color matching.
Rendering Intent	The selections below provide the ability to modify color image processing to suit specific preferences. (Color matching method: Method of color converting RGB colors on the display, etc. into CMYK colors in the printer)
Output Profile	Select a color profile for the image to be printed
CMYK Correction*1	Correct the image to obtain the optimum printing result when printing a CMYK image.
Screening	Select the screening to modify the image to suit specific preferences, according to the appropriate image processing method.
Neutral Gray	Select a creating method of neutral gray.
Pure Black Print	Select whether you want to print black data area with only black toner.
Trapping	Select to prevent void area which may be generated around edge of colors.
Sharpness	This is used to sharpen an image or make it softer.
Black Overprint*2	Prevents whitening of the outline of black text.
CMYK Simulation*2	Adjusts the colors to simulate printing that would be obtained with the process colors used in printing presses.
Simulation Profile*2	Select the simulation target.

*1 Can only be used when using the PCL6 printer driver.

*2 Can only be used when using the PS printer driver (Windows/Mac OS).



Windows

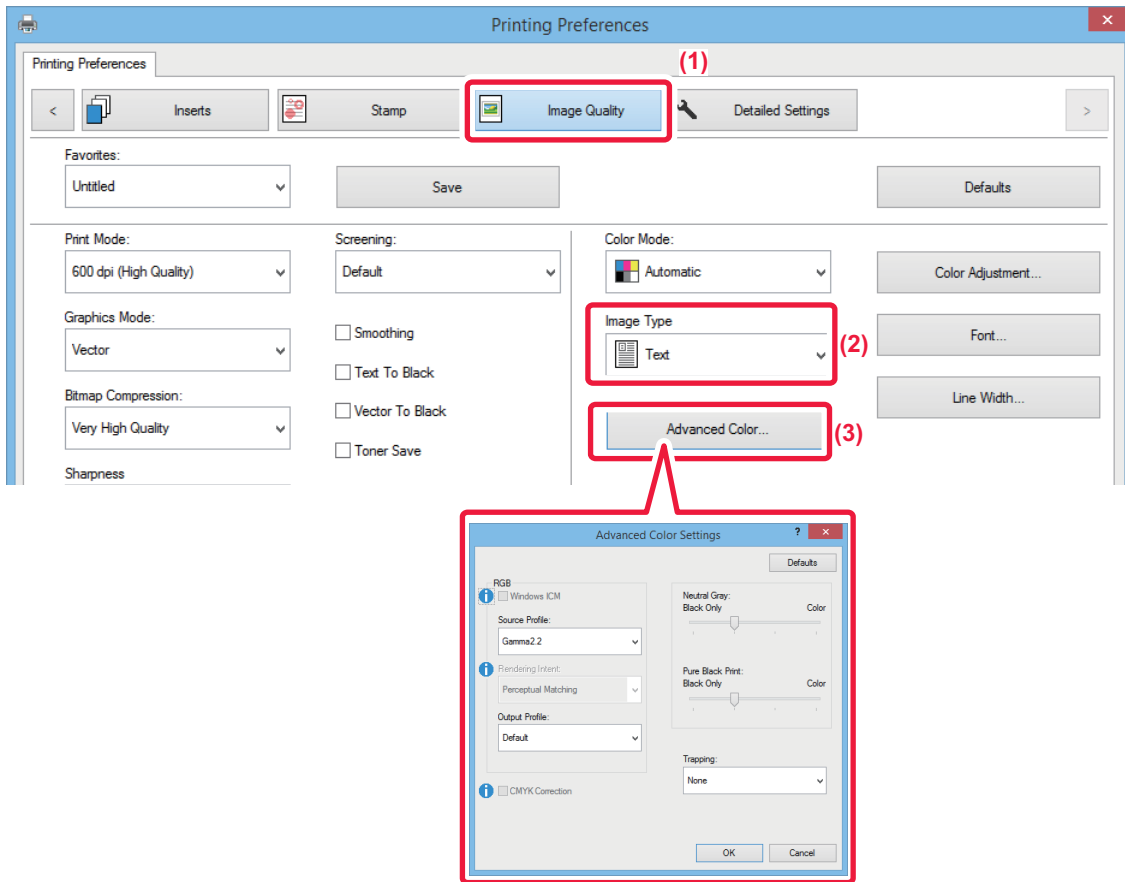

(1) Click the [Image Quality] tab.

(2) Select [Image Type].

- Text: Data consisting mostly of text
- Presentation: Data with many photos or illustrations
- Photo: Photo data or data that uses photos
- CAD: Engineering drawing data
- Scan: Data scanned by a scanner
- Colorimetric: Data to be printed in colors as viewed on the screen
- Custom: Data to be printed with special settings

(3) Click the [Advanced Color] button and specify the settings.

To configure color management using the Windows OS ICM, set "Image Type" to [Custom] in step (2). Then, click the [Windows ICM] checkbox so that the checkmark appears.

To configure "Source Profile" and other detailed color management tasks, select the desired settings from the menus.



Mac OS

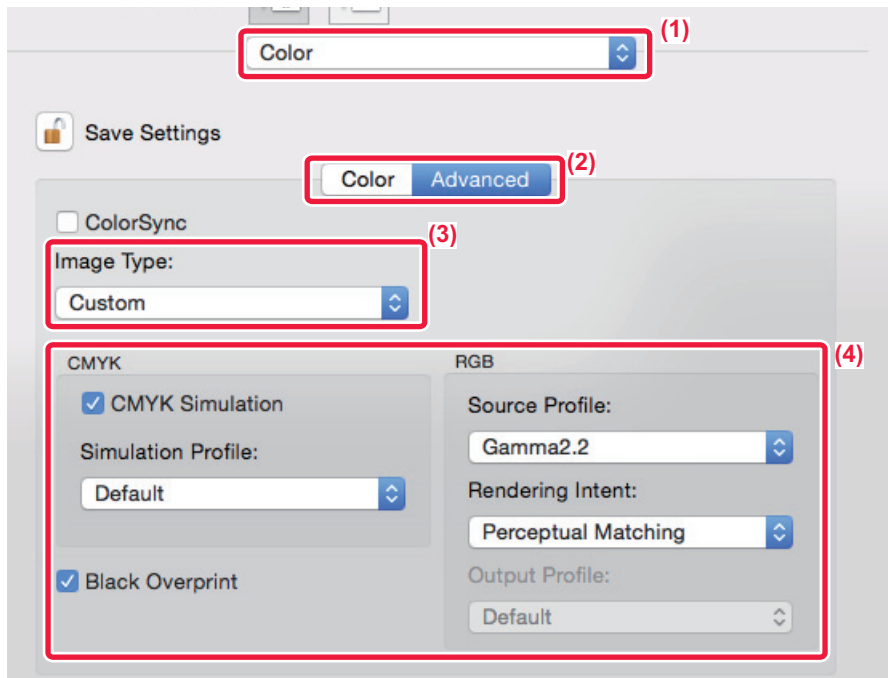

(1) Select [Color].

(2) Click the [Advanced] tab.

To use the Mac OS color management function, select the [ColorSync] checkbox so that the checkmark appears. In this case, you cannot select "Image Type".

(3) Select [Image Type].

To configure color management settings, select the desired settings from the menus. To select a "CMYK Simulation" setting, select [Custom] in "Image Type", select the [CMYK Simulation] checkbox (), and then select the desired setting.

- Text: Data consisting mostly of text
- Presentation: Data with many photos or illustrations
- Photo: Photo data or data that uses photos
- CAD: Engineering drawing data
- Scan: Data scanned by a scanner
- Colorimetric: Data to be printed in colors as viewed on the screen
- Custom: Data to be printed with special settings

(4) Specify the settings.



FUNCTIONS TO COMBINE TEXT AND IMAGES

ADDING A WATERMARK TO PRINTED PAGES (WATERMARK)

This function adds faint shadow-like text as a watermark in the background of the printed image. The size and angle of the watermark text can be adjusted.

The watermark text can be selected from the previously registered text in the list. When necessary, you can enter text to create an original watermark.

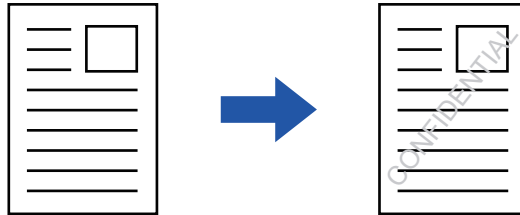

Windows

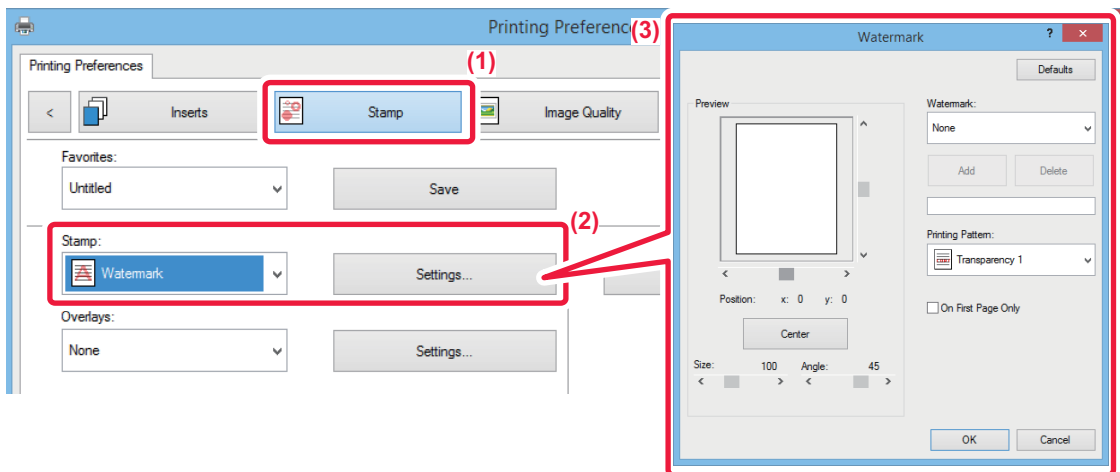

- (1) Click the [Stamp] tab.
- (2) Select [Watermark] from "Stamp" and click the [Settings] button.
- (3) Select the watermark to be used and click the [OK] button.



If you want to create a new watermark, enter the text of the watermark in the text box and click the [Add] button.



Mac OS

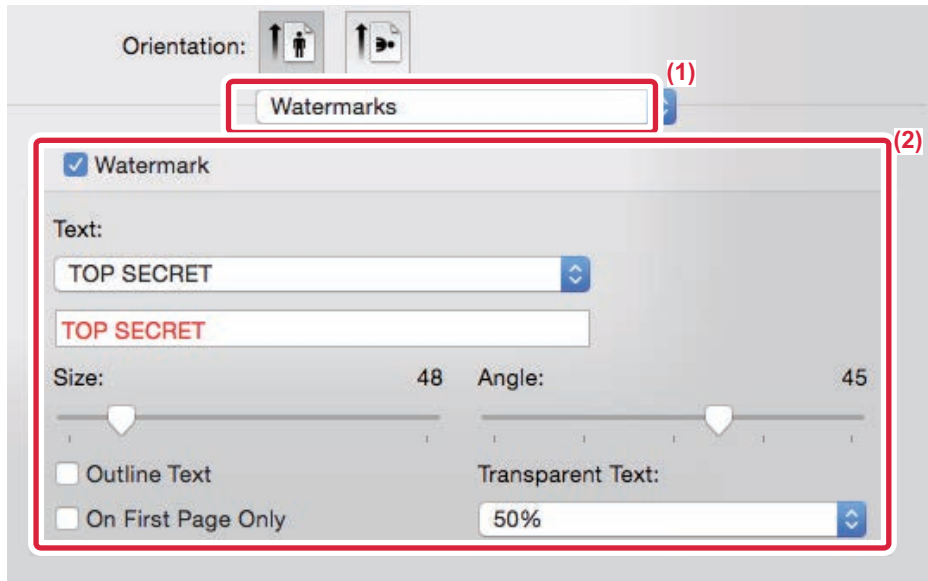

- (1) Select [Watermarks].
- (2) Click the [Watermark] checkbox and configure watermark settings.
 - Configure detailed watermark settings such as selection of the text.
 - Adjust the size and angle of the text by dragging the slide bar .



PRINTING AN IMAGE OVER THE PRINT DATA (IMAGE STAMP)

This function prints a bitmap or JPEG image stored on your PC over the print data.

This function prints a frequently used image or an icon of your own creation as if it is stamped on the print data. The size, position, and angle of the image can be adjusted.

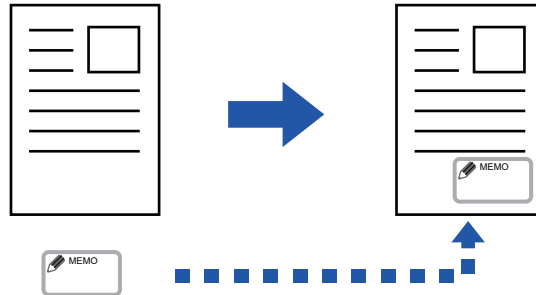

This function is available in a Windows environment.

Windows

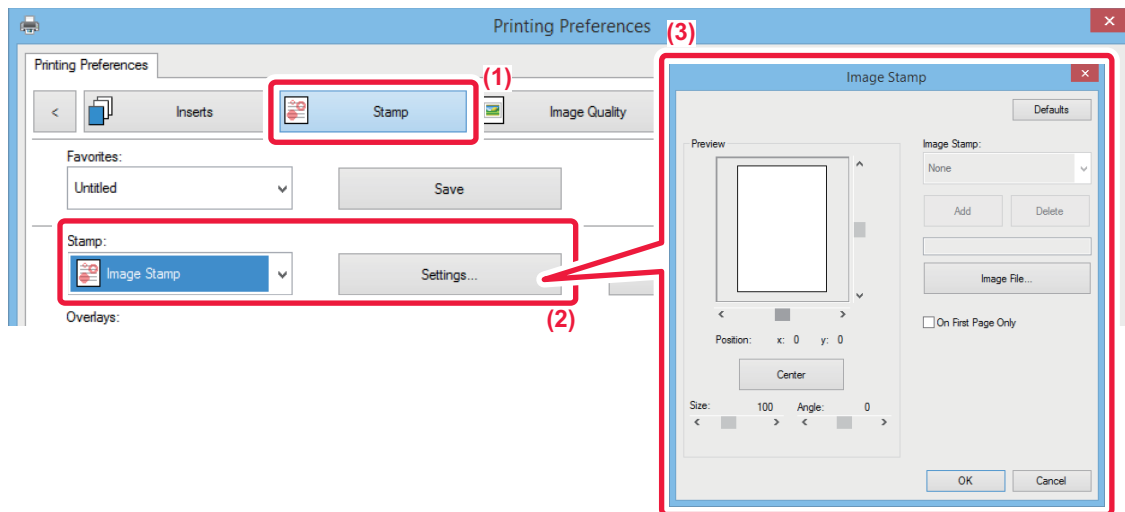

(1) Click the [Stamp] tab.

(2) Select [Image Stamp] from "Stamp" and click the [Settings] button.

(3) Select the image stamp to be used, and click the [OK] button.

- If an image stamp has already been stored, it can be selected from the menu.
- If you have not stored an image stamp, click the [Image File], select the file you wish to use for the image stamp, and click the [Add] button.



REGISTERING A CUSTOM IMAGE

This function registers images used as custom images from the printer driver to the machine.



- This function is available in a Windows environment.
- This function can be used when the PCL6 printer driver is used.



To prohibit the registration of custom images:

In "Settings (administrator)", select [System Settings] → [Common Settings] → [Enable/Disable Settings] → [Disabling Registration of Custom Image] and configure the setting.

Windows

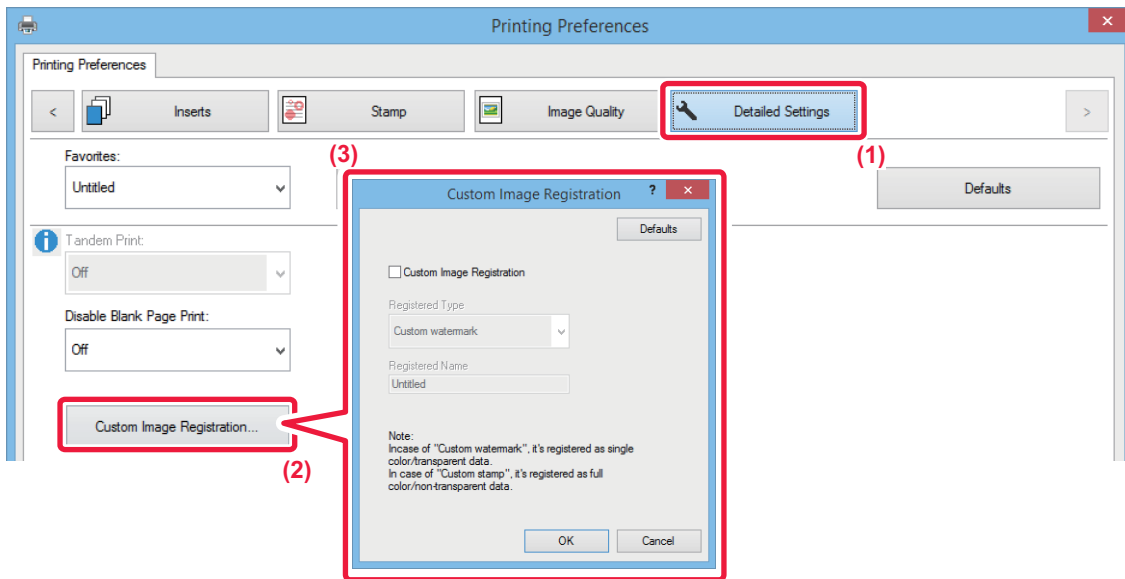

(1) Click the [Detailed Settings] tab.

(2) Click the [Custom Image Registration] button.

(3) Select the registration type and name of the custom image.

When [Custom stamp] is selected in "Registered Type", a full-color, non-transparent stamp image is registered. When [Custom watermark] is selected, a single-color, transparent watermark image is registered.



If you have attempted to store multiple pages of data, only the first page will be stored.



OVERLAY A FIXED FORM ON THE PRINT DATA (OVERLAYS)

This function overlays data on a fixed form you have prepared.

By creating table rulings or a decorative frame in an application different from that of the text file and registering the data as an overlay file, an attractive print result can be easily obtained without the need for complex manipulations.

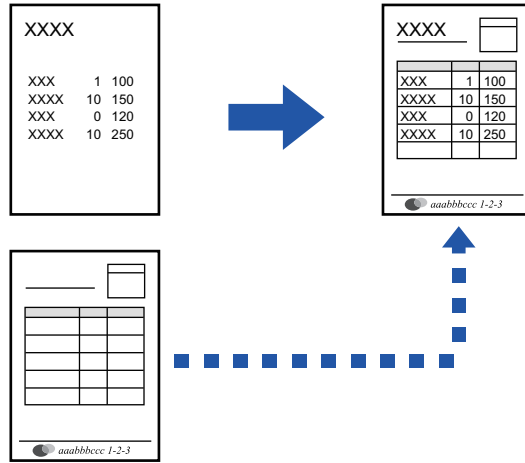

This function is available in a Windows environment.

Windows

Creating an overlay file

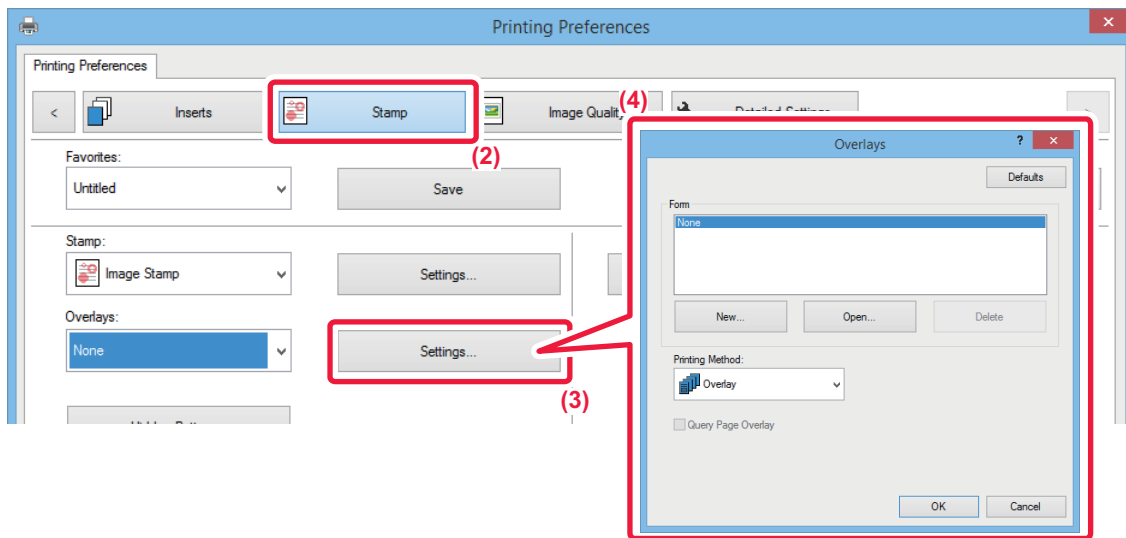

- (1) Open the driver properties window from the application that is used for creating overlay data.
- (2) Click the [Stamp] tab.
- (3) Click the [Settings] button.
- (4) Click the [New] button and specify the name and folder to be used for the overlay file that you wish to create.

The file will be created when the settings are completed and printing is started.



- When printing is started, a confirmation message will appear. The overlay file will not be created until the [Yes] button is clicked.
- When you click the [Open] button, the existing overlay file is registered.

Printing with an overlay file

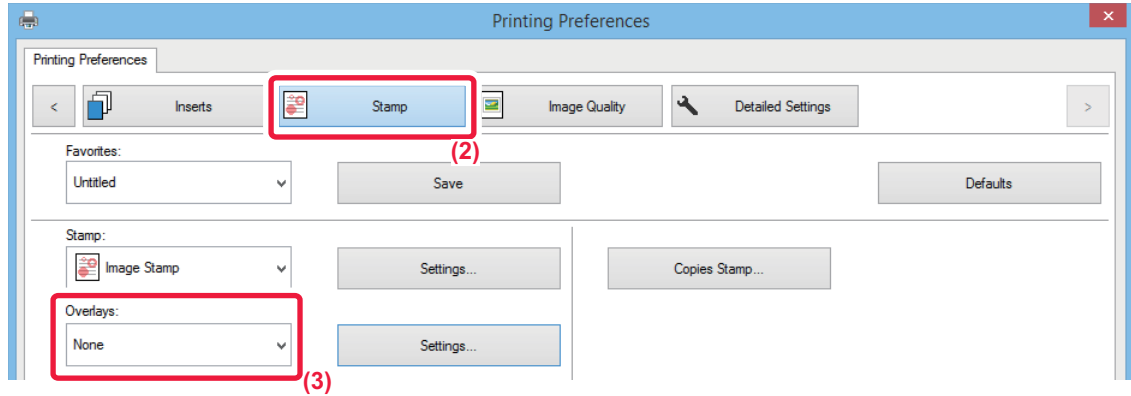

- (1) Open the driver properties window from the application that is used for printing with an overlay file.
- (2) Click the [Stamp] tab.
- (3) Select an overlay file.
A previously created or stored overlay file can be selected from the menu.



ADDING THE NUMBER OF COPIES (COPIES STAMP)

You can add the number of copies to the header or footer of the print data. You can also set a copies number and print position.



This function is available in a Windows environment.

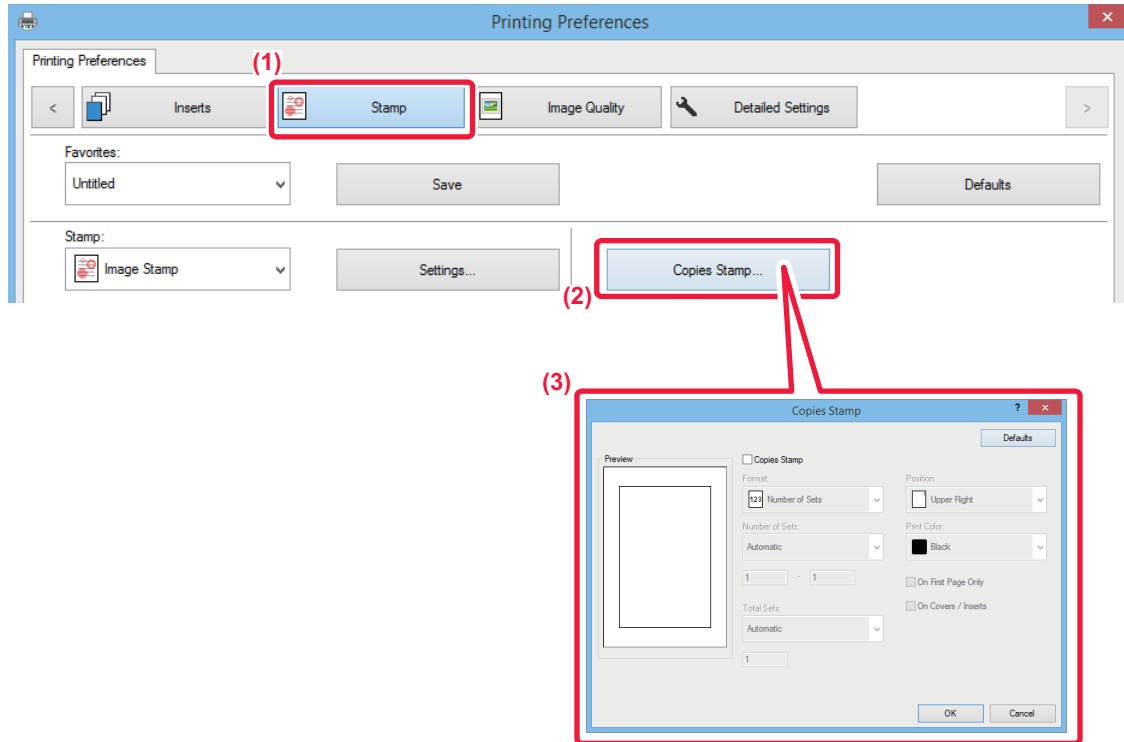

- (1) Click the [Stamp] tab.
- (2) Click the [Copies Stamp] button.
- (3) Select the settings, and click the [OK] button.



PRINT FUNCTIONS FOR SPECIAL PURPOSES

PRINTING SPECIFIC PAGES ON DIFFERENT PAPER (DIFFERENT PAPER)

In a Windows environment

The front and back covers and specified pages of a document are printed on paper that is different from the other pages. Use this function when you wish to print the front and back covers on heavy paper, or insert colored paper or a different paper type at specified pages.

As necessary, paper can be inserted as insertion sheets where nothing is printed.

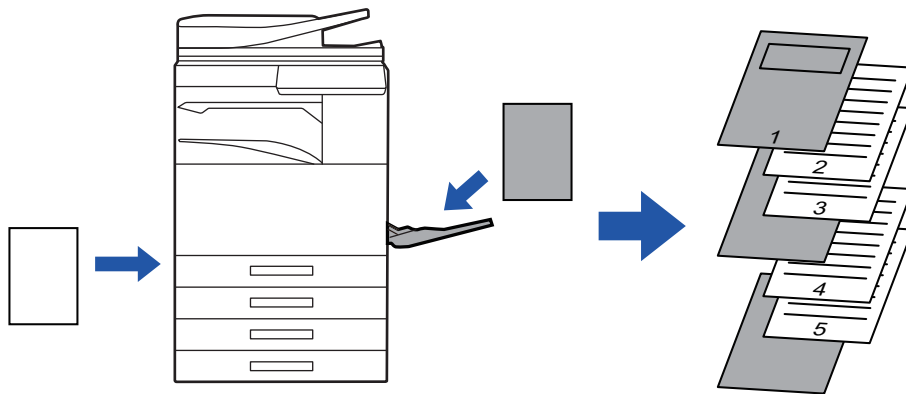

In a Mac OS environment

The front and back covers are printed using paper that is different from the other pages. This function can be used, for example, when you want to print only the front cover and last page on thick paper.

Windows

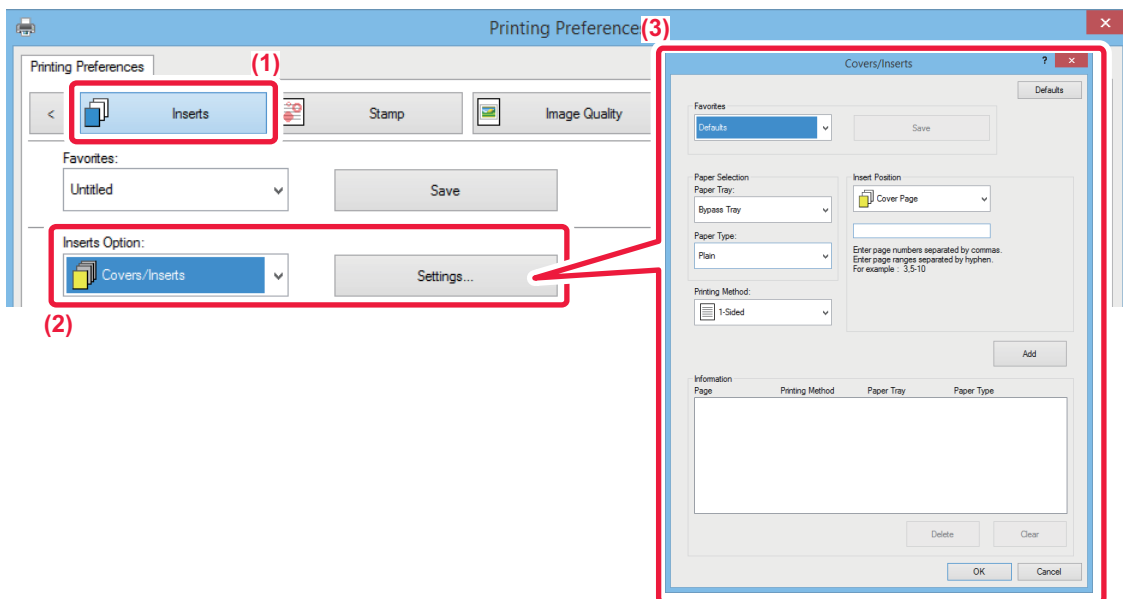

- (1) Click the [Inserts] tab.
- (2) Select [Covers/Inserts] from [Inserts Option], and click the [Settings] button.
- (3) Select the paper insertion settings.
 - Select the insertion position, paper source, and printing method from the corresponding menus.



- Click the [Add] button and your settings will appear in "Information".
- When you have finished selecting settings, click the [Save] button in "Favorites" to save the settings.



- When [Bypass Tray] is selected in "Paper Tray", be sure to select the "Paper Type" and load that type of paper in the bypass tray.
- When [Other Page] is selected for "Insert Position", specify the insert position by directly entering a page number. When "Printing Method" is set to [2-Sided Printing], the specified page and the next page after it will be printed on the front and reverse side of the paper, and thus an insert setting at a page printed on the reverse side will not be effective.

Mac OS

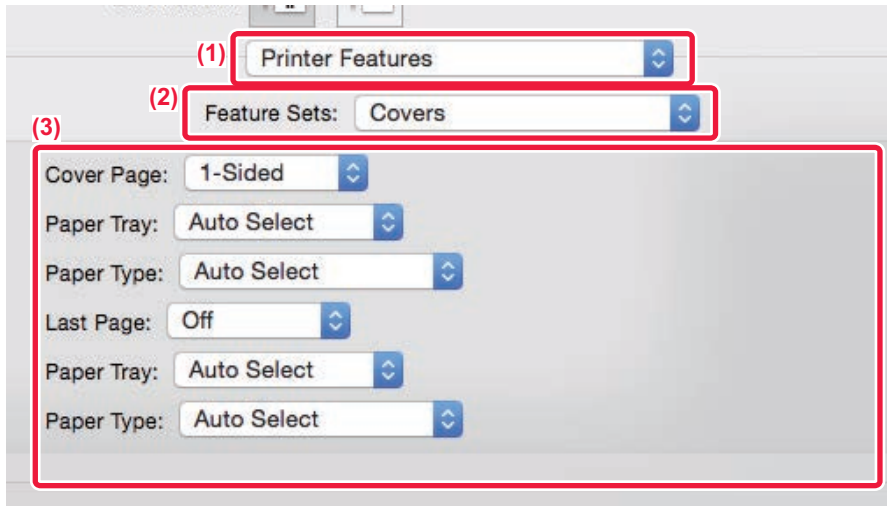

(1) Select [Printer Features].

(2) Select [Covers].

(3) Select the cover insertion settings.

Select the print setting, paper tray, and paper type for the front and back covers.



ADDING INSERTS WHEN PRINTING ON TRANSPARENCY FILM (TRANSPARENCY INSERTS)

When transparency film is used for printing, this function prevents the sheets of transparency film from sticking together by inserting a sheet of paper between each sheet of film. As necessary, the same content as that printed on each sheet of transparency film is also printed on the corresponding sheet of inserted paper.

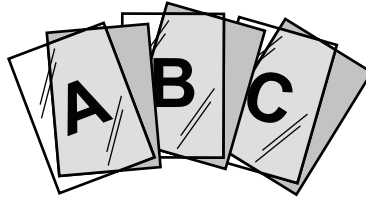

This function is available in a Windows environment.

Windows

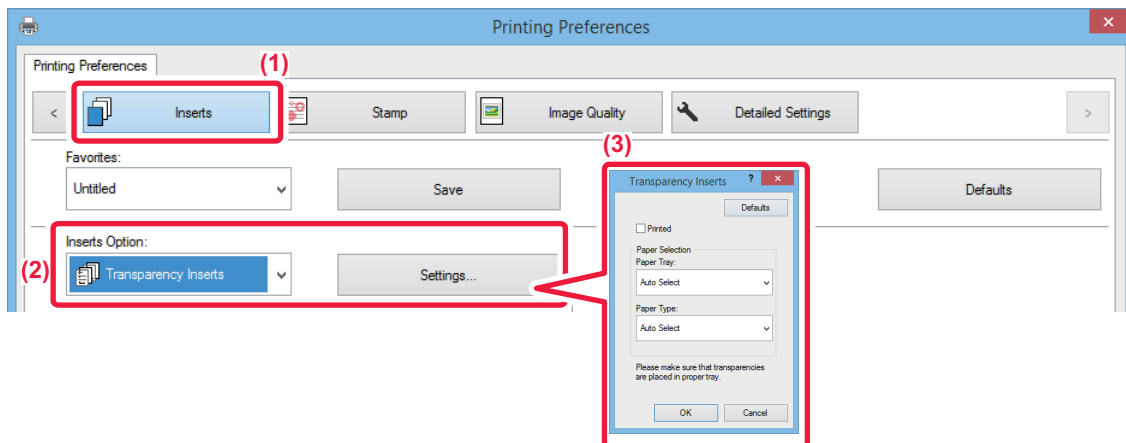

(1) Click the [Inserts] tab.

(2) Select [Transparency Inserts] and click the [Settings] button.

Select the print setting, paper tray, and paper type for the front and back covers.

(3) Select the transparency insert settings.

When the [Printed] checkbox is selected to set to , the same content as that printed on the transparency film is also printed on the insert. Select the paper source and type if needed.



Set the paper type of the bypass tray to [Transparency] and load transparency film into the bypass tray.



Mac OS

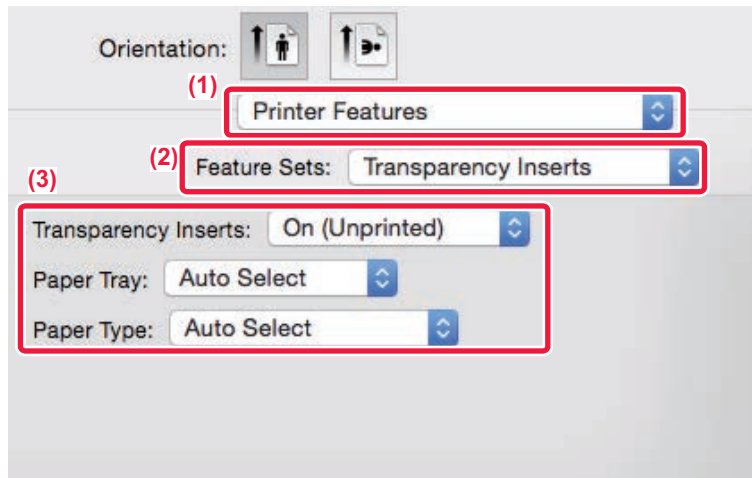

- (1) Select [Printer Features].
- (2) Select [Transparency Inserts] in "Feature Sets".
- (3) Select the transparency insert settings.

When [On (Printed)] is selected from "Transparency Inserts", the same content as that printed on the transparency film is also printed on the insert. Select the paper source and type if needed.



Set the paper type of the bypass tray to [Transparency] and load transparency film into the bypass tray.



INSERTING SEPARATOR PAGES BETWEEN JOBS OR COPIES

You can insert separator pages between jobs or the specified number of copies.

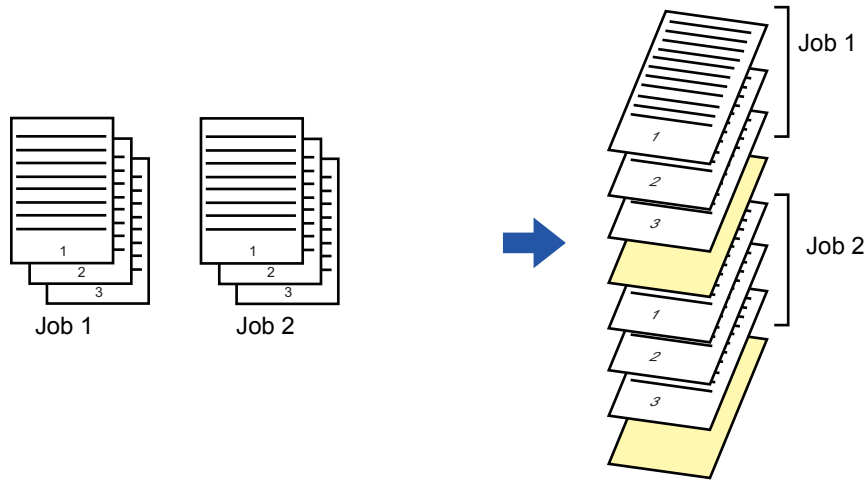

This function is available in a Windows environment.

Windows

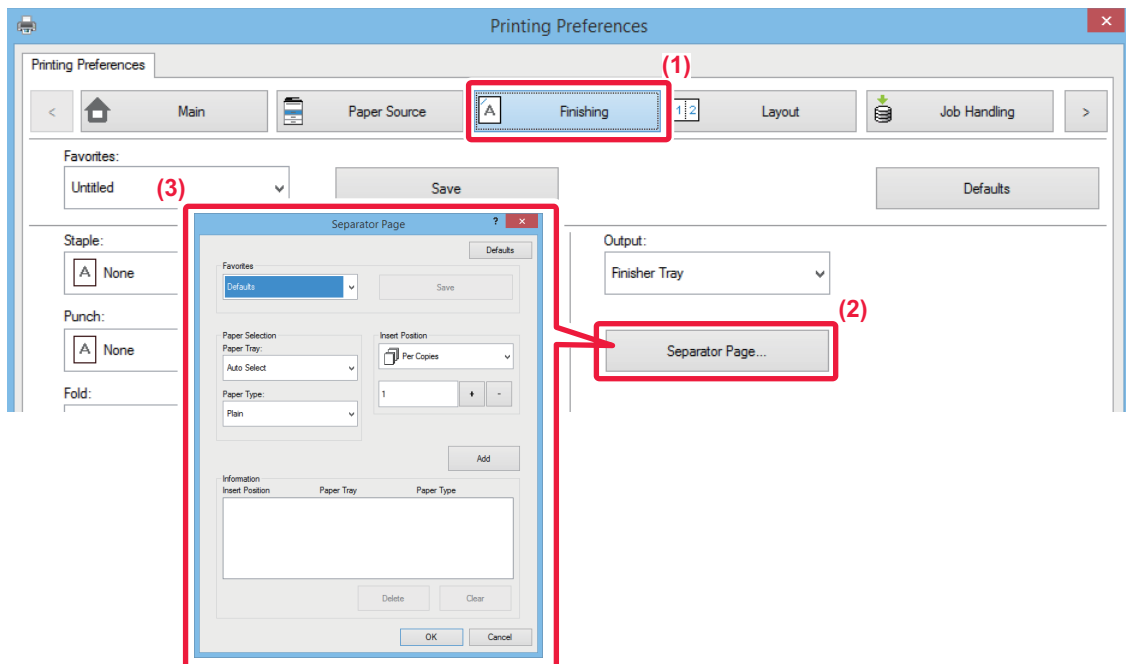

- (1) Click the [Finishing] tab.
- (2) Click the [Separator Page] button.
- (3) Changing the settings
 - Select the paper tray and paper type from "Paper Selection", and specify the separator page position in "Insert Position".
 - To add a separator page each time printing of the set number of copies is completed, select [Per Copies] in "Insert Position".
 - For example, if you are printing 10 copies and you select "5", a separator page will be added after the 5th copy and after the 10th copy.



When the bypass tray is selected, be sure to select the "Paper Type".



PRINTING A CARBON COPY (CARBON COPY)

This function prints an additional copy of the print image on paper that is of the same size but from a different paper tray. For example, if carbon copy print is selected when plain paper is loaded into tray 1 and colored paper is loaded into tray 2, a print result similar to a carbon copy slip is obtained with a single selection of the print command. If plain paper is loaded into tray 1 and recycled paper is loaded into tray 2 as necessary, selecting Carbon Copy simultaneously prints one copy for presentation and one copy as a duplicate.

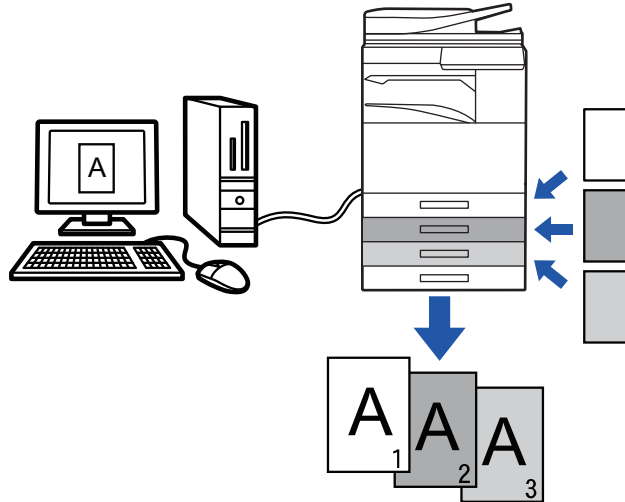

This function is available in a Windows environment.

Windows

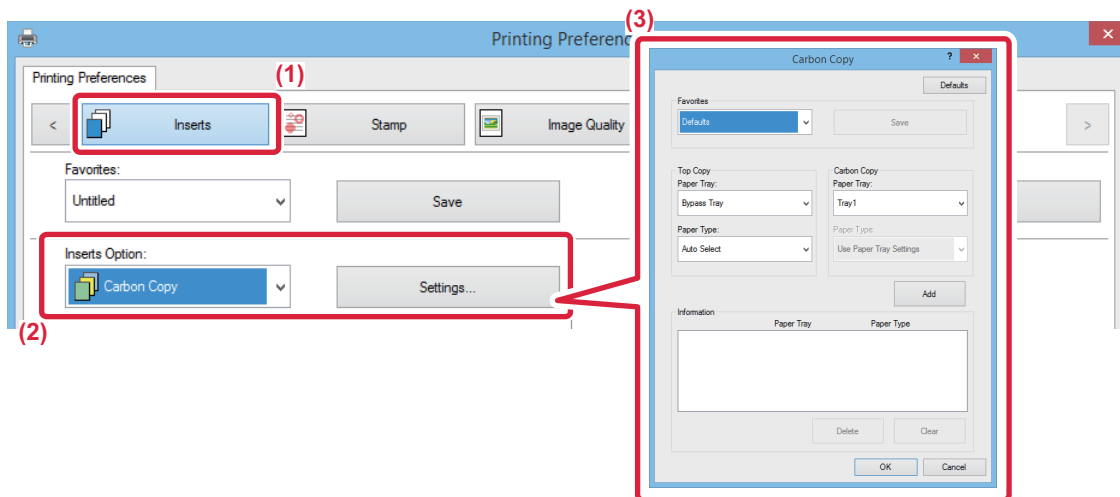

- (1) Click the [Inserts] tab.
- (2) Select [Carbon Copy] from "Inserts Option" and click the [Settings] button.
- (3) Select the tray for the first copy from "Top Copy", and then select the tray for the carbon copy from "Carbon Copy".



When the bypass tray is selected, be sure to select the "Paper Type".



PRINTING TEXT ON TABS OF TAB PAPER (TAB SHIFT/TAB PAPER PRINT)

There are two methods of printing on the tabs of tab paper: "Tab Shift" and "Tab Paper Print".

Tab Shift

Create the text to be printed on tab paper in an application, and set the text shifting distance in [Print Position] on the [Layout] tab of the printer driver property window. The text will be printed on the tabs.

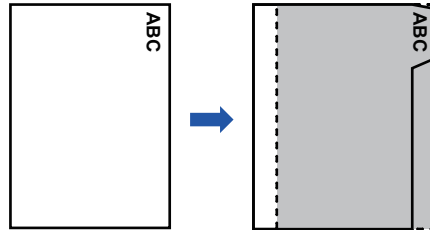

Tab Paper Print (for PCL6 only)

Tab sheets are printed while they are inserted between the desired pages.

Select [Tab Paper] in [Inserts Option] on the [Inserts] tab of the printer driver properties window, and enter the text that you want to print on the tabs. Specify the detailed settings such as the size of the tabs, the starting position, the distance between tabs, and the page numbers where tab sheets will be inserted.

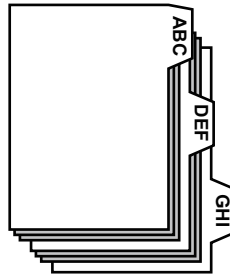

- These functions are available in a Windows environment.
- Tab paper must be loaded into the bypass tray.



Windows

Tab Shift

When you have finished preparing the data to be printed on tab papers in an application, take the following steps:

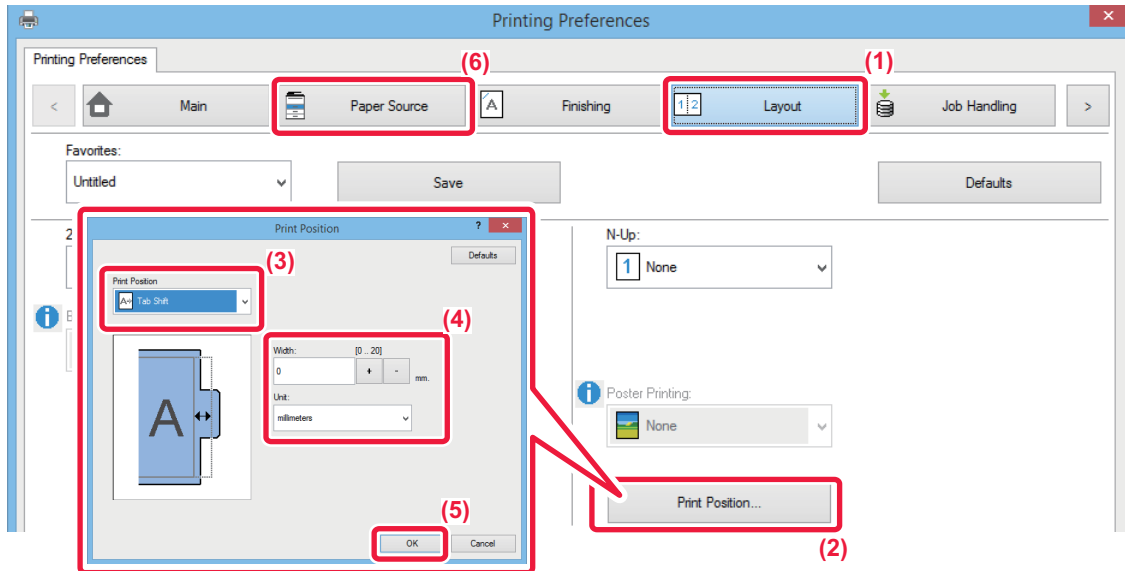

- (1) Click the [Layout] tab.
- (2) Click the [Print Position] button.
- (3) Select [Tab Shift].
- (4) Specify the distance of shifting the image by directly entering a value or by clicking the button.
- (5) Click the [OK] button.
- (6) Select the paper source and type.
Click the [Paper Source] tab, and select [Bypass Tray] in "Paper Tray" and [Tab Paper] in "Paper Type".



Set the paper type of the bypass tray to [Tab Paper] and load tab papers into the bypass tray.



Tab Paper Print (for PCL6 only)

Open the data into which you wish to insert tab paper, and then select the settings.

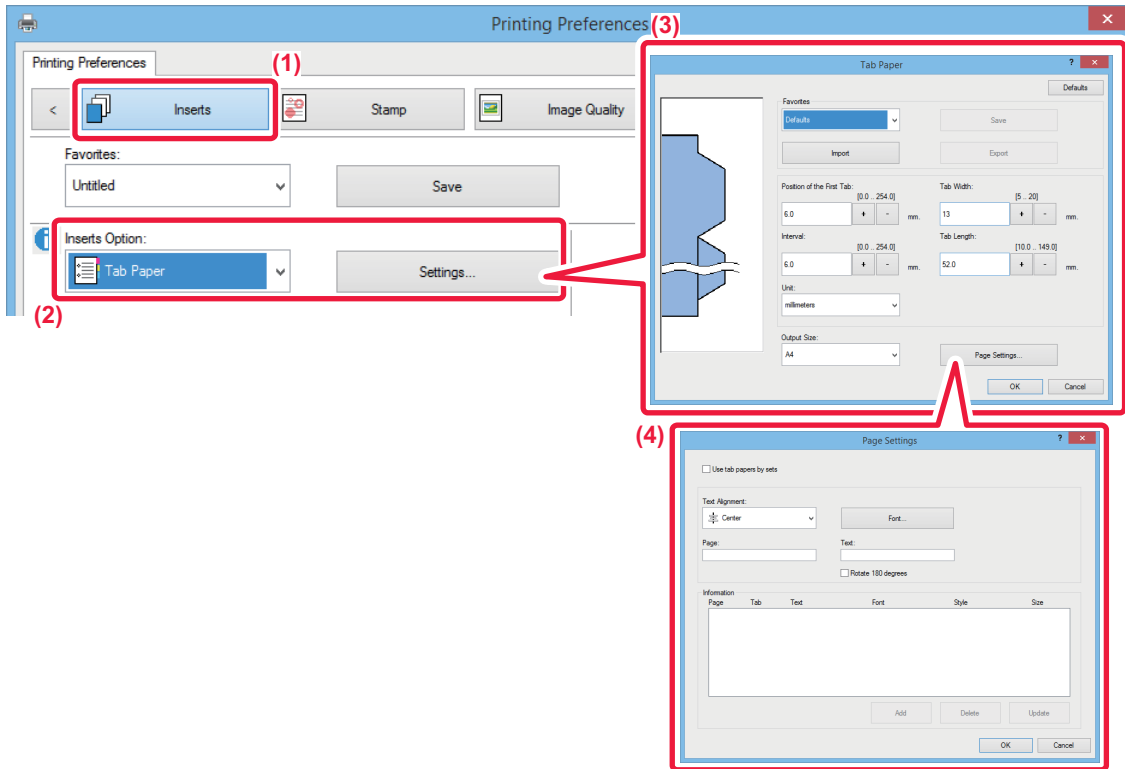

(1) Click the [Inserts] tab.

(2) Select [Tab Paper] from "Inserts Option", and click the [Settings] button.

(3) Select the tab position settings.

For commercially available tab paper, use the existing settings such as [A4-5tab-D] in "Favorites". For other types of tab paper, the position of the first tab, the distance between tabs, and the horizontal and vertical dimensions of the tab can be directly entered or changed using the button. In addition, select the size of the tab paper from "Output Size".

(4) Select the page settings.

Specify the pages where you wish to insert tab paper and enter the text that you wish to print on the tabs. Also select the font and adjust the layout.



- Set the paper type of the bypass tray to [Tab Paper] and load tab papers into the bypass tray.
- The tab paper settings can be stored and a stored file can be opened from "Favorites".



TWO-SIDED PRINTING WITH SPECIFIC PAGES PRINTED ON THE FRONT SIDE (CHAPTER INSERTS)

This function prints specific pages on the front side of the paper.

When you specify a page (such as a chapter cover page) to be printed on the front side of the paper, it is printed on the front side of the next sheet even if it would normally be printed on the reverse side of the paper.



Example: When pages 4 and 8 are specified as page settings.
(Back is blank)



- This function is available in a Windows environment.
- This function can be used when the PCL6 printer driver is used.

Windows

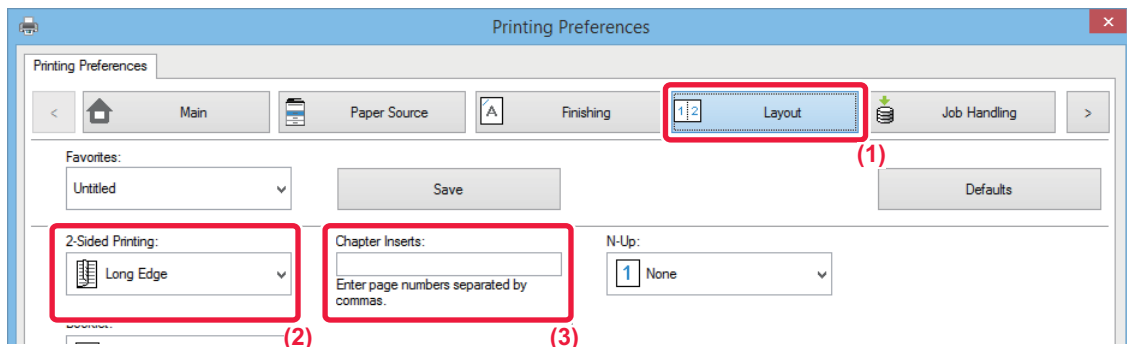

- (1) Click the [Layout] tab.
- (2) Select the 2-Sided Printing.
For information on the "2-Sided Printing" setting, see "[2-SIDED PRINTING \(page 3-22\)](#)".
- (3) Enter the page numbers of the initial pages of the chapters, separating the numbers with commas.



FOLDING PRINTED PAPER IN HALF (FOLD)

This function folds printed paper in half when a saddle finisher is installed on the machine. You can choose whether the output is folded inward or outward.

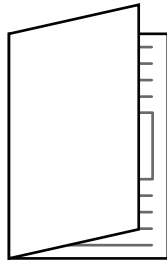

Fold Inside



Fold Outside



This function cannot be used when [Common Settings] in "Settings (administrator)" → [Device Control] → [Disabling of Duplex] is selected.



When printing data in a pamphlet layout, the "Booklet" function can be used to conveniently fold and staple printed output to create a pamphlet. See "[CREATE A PAMPHLET \(BOOKLET/SADDLE STITCH\)](#) (page 3-30)".

Windows

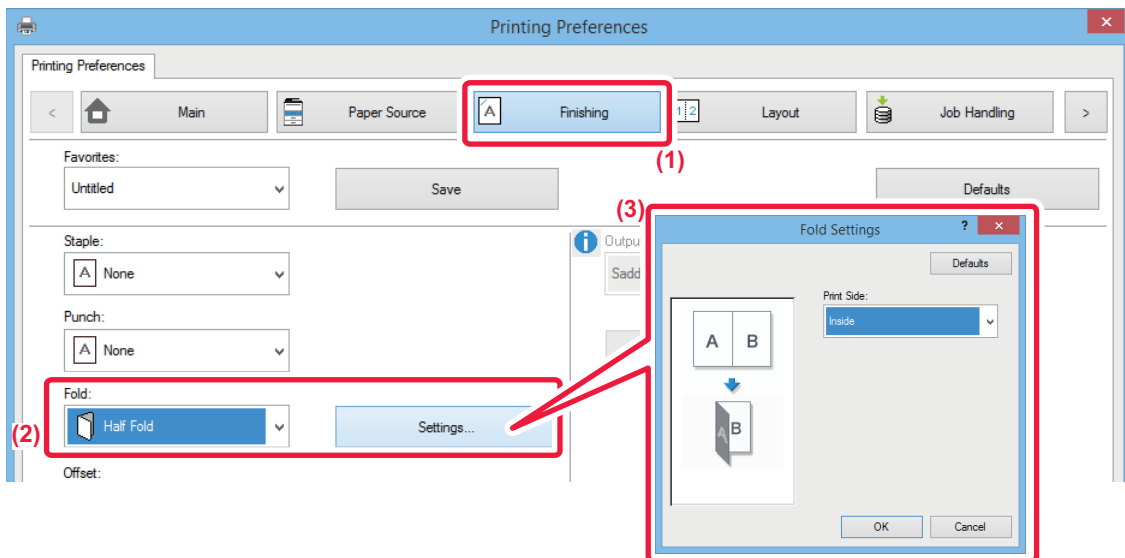

- (1) Click the [Finishing] tab.
- (2) Select [Half Fold] in "Fold", and click the [Settings] button.
- (3) Select the desired folding method.



Mac OS

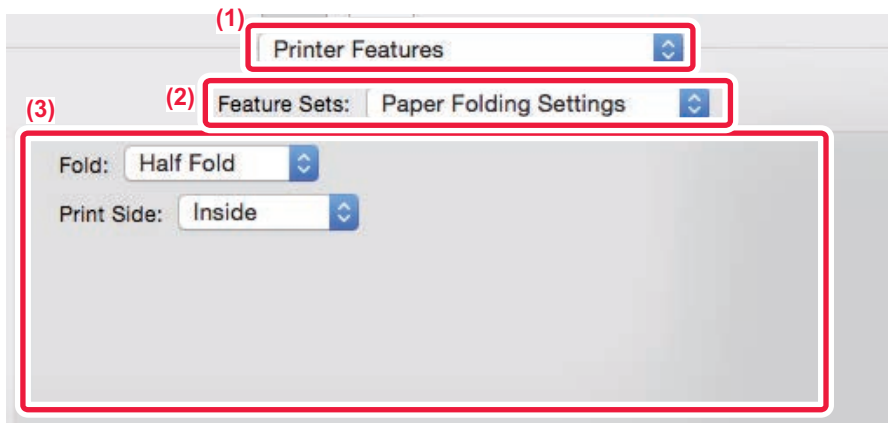

- (1) Select [Printer Features].
- (2) Select [Paper Folding Settings].
- (3) Select the desired folding method.



INSERT PRESET DATA BEFORE OR AFTER EACH PAGE (PAGE INTERLEAVE)

This function inserts a preset data item into every page during printing.

You can easily create documents with opened page spread that is made up of text on the left-hand page and a memo space on the right-hand page.

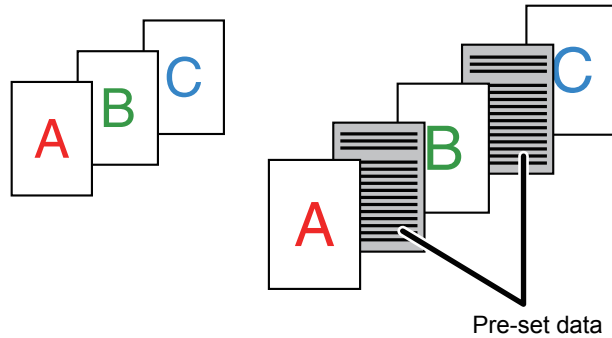

- This function is available in a Windows environment.
- This function can be used when the PCL6 printer driver is used.

Windows



You have to create page data to be inserted in advance.

For the procedure for creating page data, see "[Creating an overlay file \(page 3-52\)](#)" in "[OVERLAY A FIXED FORM ON THE PRINT DATA \(OVERLAYS\) \(page 3-52\)](#)".

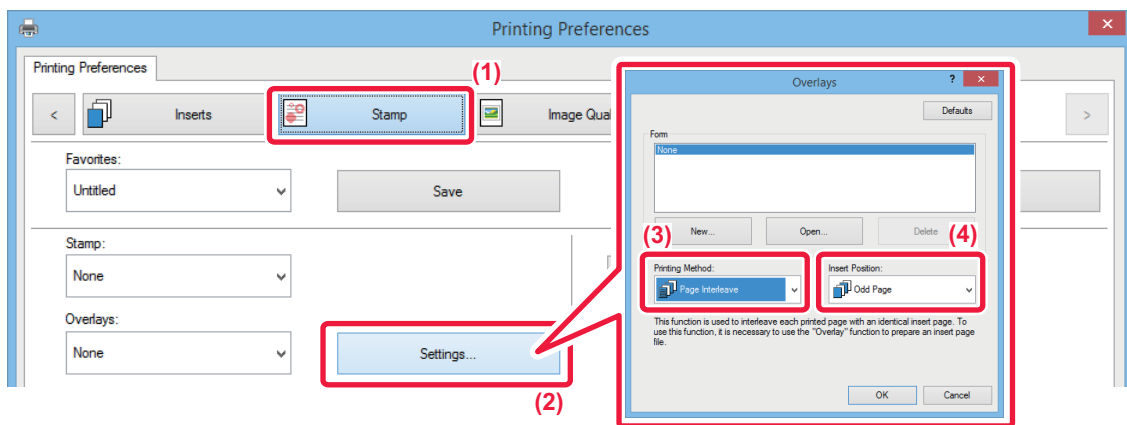

- (1) Click the [Stamp] tab.
- (2) Click the [Settings] button.
- (3) Select [Page Interleave] from the "Printing Method".
- (4) Set the overlay data to be inserted and set its insertion position.



PRINT THE SAME IMAGE IN TILE PATTERN (REPEAT PRINT)

This function prints the same image in tile pattern on a sheet. This is useful for producing name cards and stickers.

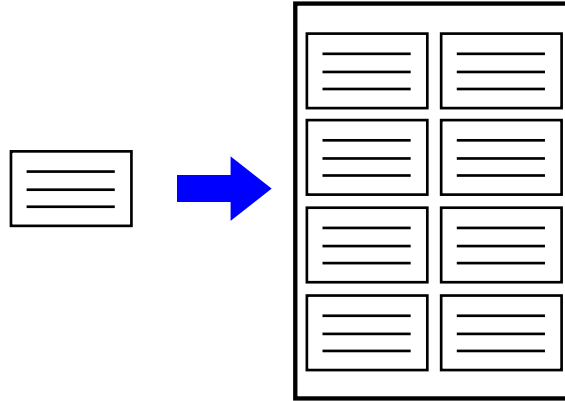

- This function is available in a Windows environment.
- This function can be used when the PCL6 printer driver is used.

Windows

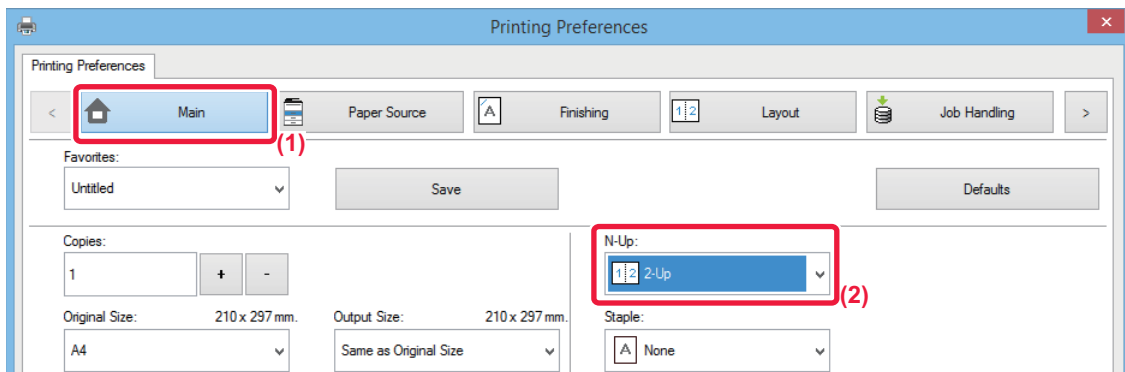

- (1) Click the [Main] tab.
- (2) Select the repeat count in "N-Up".



PRINTING PATTERN DATA (HIDDEN PATTERN PRINT)

This function prints pattern data such as "DO NOT COPY" behind the print data.

If paper with pattern data is duplicated, the pattern data emerges in the background, which will help to prevent information from being leaked through unauthorized document copying.

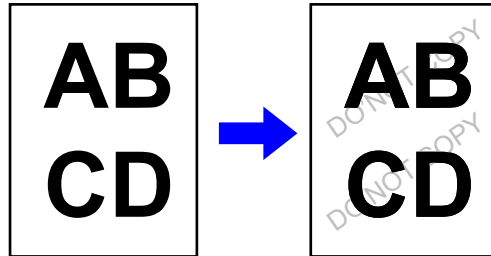

- This function is available in a Windows environment.
- This function can be used when the PCL6 printer driver is used.

Windows

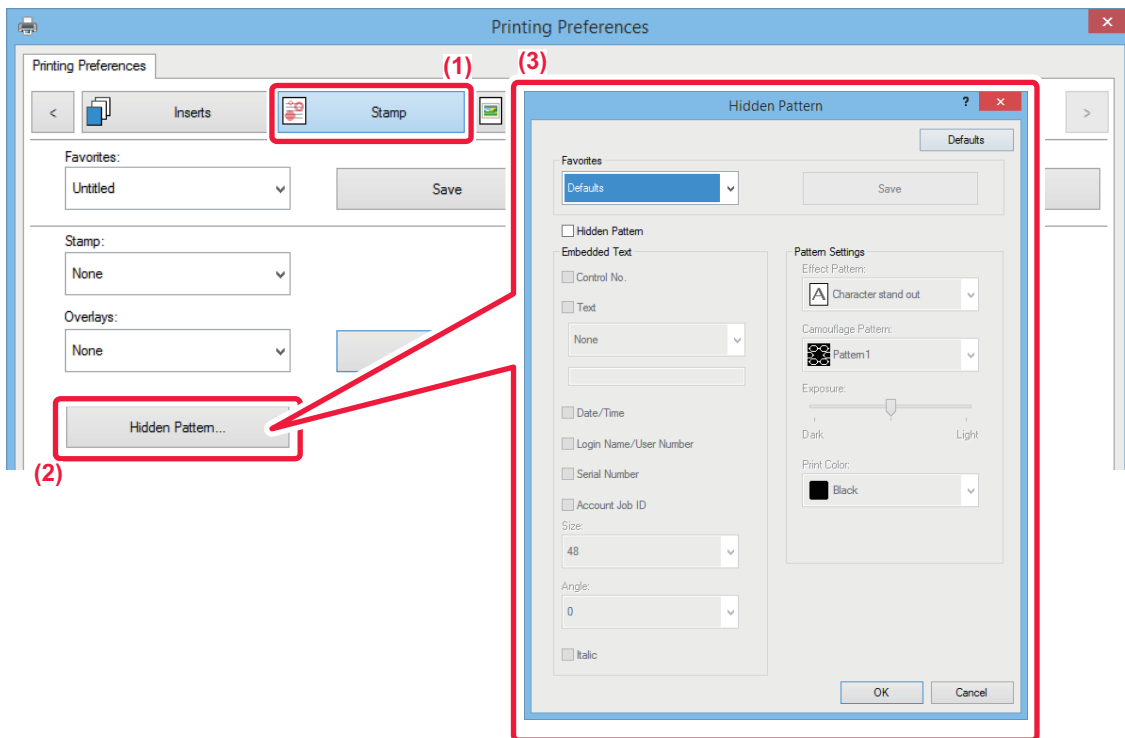

- (1) Click the [Stamp] tab.
- (2) Click the [Hidden Pattern] button.
- (3) Configure the settings for hidden pattern printing and click the [OK] button.



The hidden pattern printing function cannot be used when "Print Mode" is set to [1200 dpi].



- "Hidden Pattern" is a function provided for the purpose of deterring unauthorized printing. It does not guarantee the prevention of information leakage.
- Text may not be completely hidden on an output sheet with a pattern print under certain machine conditions. In "Settings (administrator)", select [Security Settings] → [Hidden Pattern Print Setting] → [Contrast] if this is the case.
- The hidden pattern may not emerge on copies with certain types of devices or under certain setting conditions used to copy an output sheet with a pattern print.
- When the color mode is set to [Black and White] or when it is set to [Automatic] and the original is recognized as black and white, a black background pattern is printed even if a cyan or magenta pattern is selected.



CHANGING THE RENDERING METHOD AND PRINTING JPEG IMAGES (USE DRIVER TO RENDER JPEGS)

In some situations, a document containing a JPEG image may not be printed correctly. This can be solved by changing the way the JPEG image is rendered.

When you print an original containing JPEG images, this function allows you to select whether the images are rendered in the printer driver or the machine.



- This function is available in a Windows environment.
- When images are rendered in the printer driver, it may take time until the printing is completed.

Windows

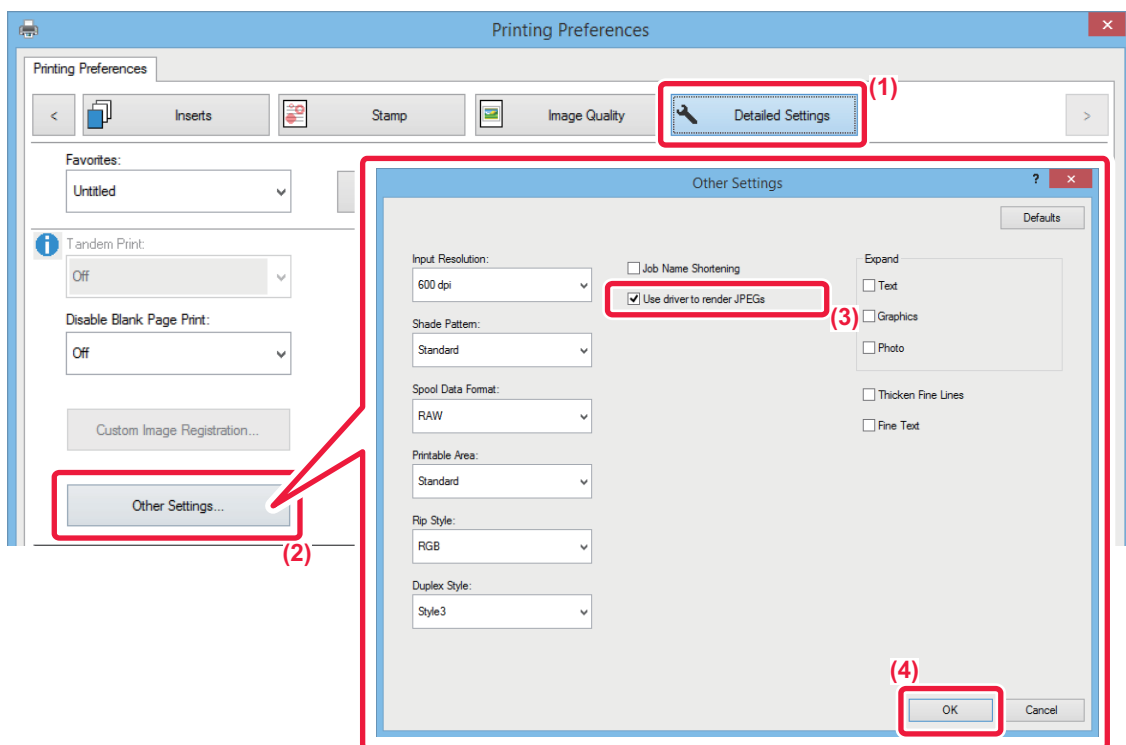

- (1) Click the [Detailed Settings] tab.
- (2) Click the [Other Settings] button.
- (3) Click the [Use driver to render JPEGs] checkbox so that appears.
- (4) Click the [OK] button.



MAXIMIZING THE PRINT AREA ON THE PAPER (PRINT AREA)

By maximizing the print area, you can print on the full paper size.



This function is available in a Windows environment.



Even when the print area is maximized, edges may be cut off.

Windows

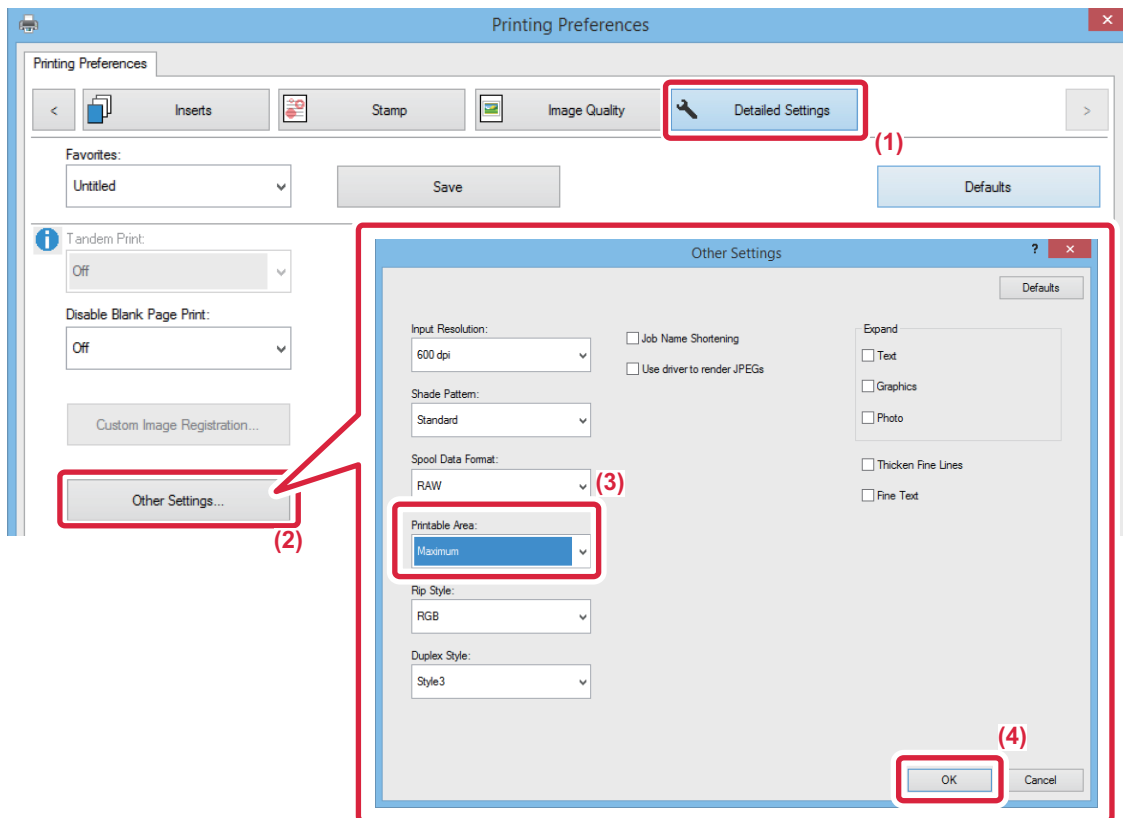

- (1) Click the [Detailed Settings] tab.
- (2) Click the [Other Settings] button.
- (3) Select [Maximum] from the "Printable Area".
- (4) Click the [OK] button.



PRINTING AT AN ENHANCED RESOLUTION (SMOOTHING)

Resolution enhancement techniques (RETs) are used to smoothen the outlines of images. The images are printed at a digitally enhanced resolution.



This function is available in a Windows environment.

Windows

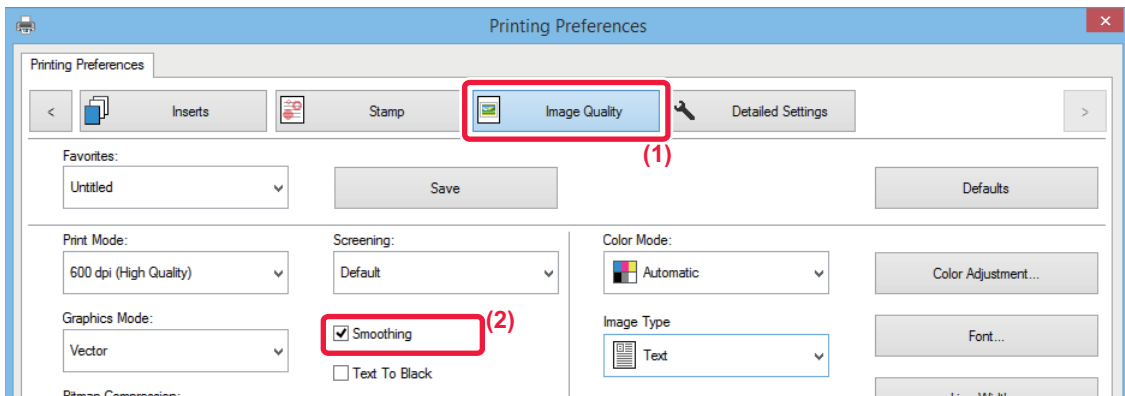

- (1) Click the [Image Quality] tab.
- (2) Select the [Smoothing] checkbox so that appears.



CONVENIENT PRINTER FUNCTIONS

USING TWO MACHINES TO PRINT A LARGE PRINT JOB (TANDEM PRINT)

To use this function, two machines that can perform tandem printing are required.

Two machines connected to the same network are used to run a large print job in parallel. This function reduces the printing time when you handle a large number of prints.

Example: Printing four sets of copies

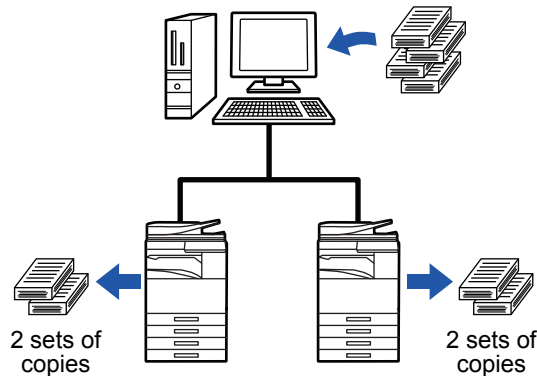

To use the tandem print function, the IP address of the client machine must be registered in the printer driver.

- In a Windows environment, this is accomplished automatically by clicking the [Auto Configuration] button on the [Configuration] tab of the printer driver.
- In Mac OS 10.6 to 10.8, this is accomplished automatically by clicking the [Update] button (or [Tandem Settings] button) on the "Tandem Print" screen. In Mac OS 10.9, enter the IP address of the client machine.



This function cannot be used in Mac OS X 10.10 or later.



Windows

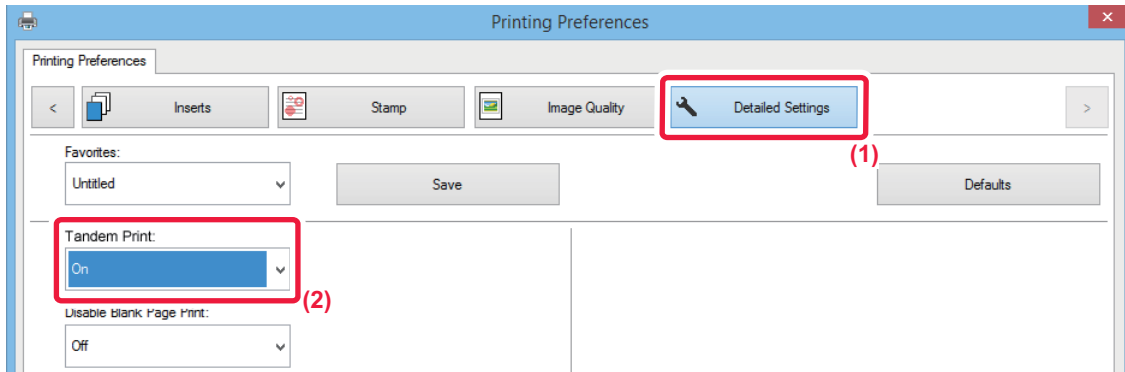

- (1) Click the [Detailed Settings] tab.
- (2) Select [On] in "Tandem Print".



The tandem print function can be used only when the printer driver has been installed using "Custom Installation" with [LPR Direct Print (Specify Address/Auto Search)] selected and with the [Yes] checkbox selected for "Do you want to use Tandem Print function?".

Mac OS

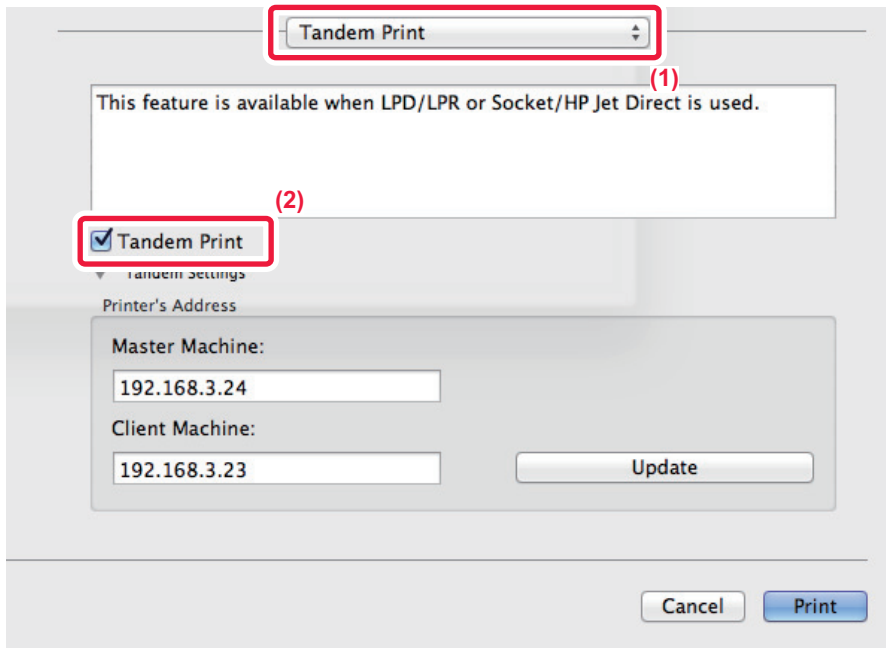

- (1) Select [Tandem Print].
- (2) Click the [Tandem Print] checkbox so that appears.



To use the tandem print function, you must select the protocol to be used as instructed in the message that appears when you add the printer driver in the "Printer Setup Utility".



SAVING AND USING PRINT FILES (DOCUMENT FILING)

This function stores a print job as a file on the machine's hard drive, allowing the job to be printed from the touch panel when needed. The location for storing a file can be selected to prevent the file from being mixed together with files of other users.

- **Hold Only**

This setting is used to hold a print job on the machine's hard drive without printing it.

- **Hold After Print**

This setting is used to hold a print job on the machine's hard drive after it is printed.

- **Sample Print**

When a print job is sent to the machine, only the first set of copies is printed. After checking the contents of the first set of copies, you can print the remaining sets from the operation panel of the machine. This prevents the occurrence of excessive misprints.

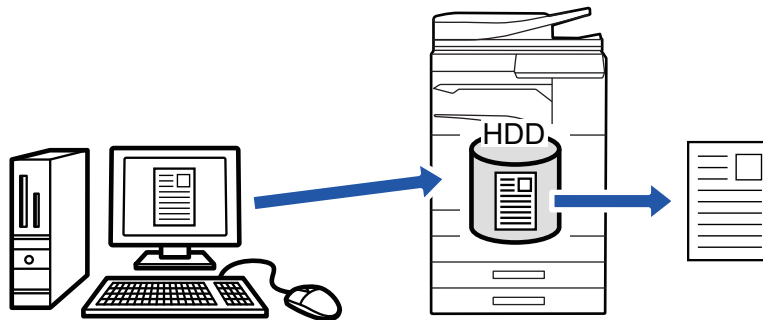

- For the procedure for printing files stored on the machine's hard drive, see "[FILE PRINTING \(page 6-22\)](#)" in "Document Filing".
- When printing from a PC, you can set a password (5 to 8 digits) to maintain the confidentiality of information in a stored file. When a password is set, the password must be entered to print data.
- [Document Filing] that can be set on the [Job Handling] tab can also be set on the [Main] tab.

Windows

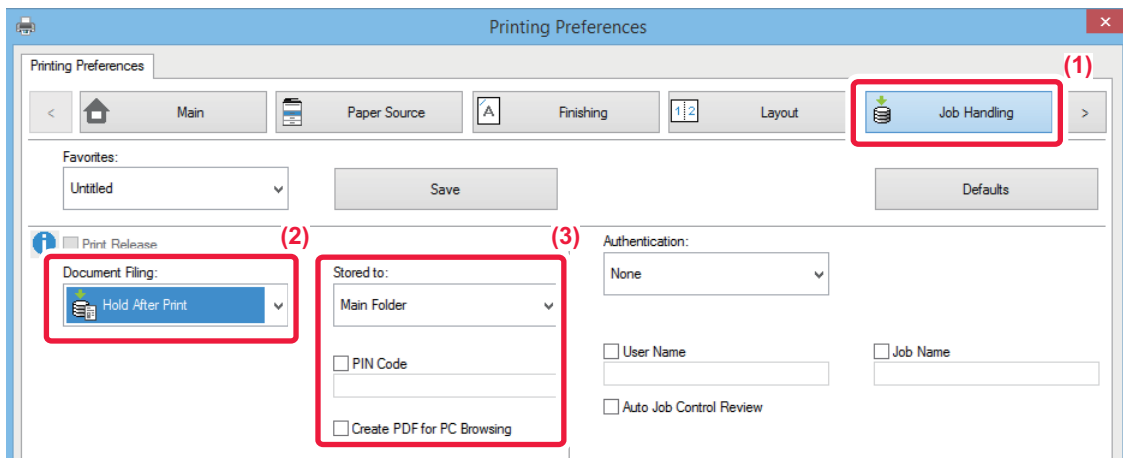

- (1) Click the [Job Handling] tab.
- (2) Select the function from the "Document Filing".
- (3) Select the folder for storing the file in "Stored to".

To enter a password (5 to 8 digit number), click the [PIN Code] checkbox so that the checkmark appears.
To create a public PDF for PC browsing, select the [Create PDF for PC Browsing] checkbox (.



- When [Quick File] is selected, "Document Filing" will be set to [Hold After Print].
- When [Quick File] is selected, the password entered in "Document Filing" is cleared.
- If necessary, you can select the data format from CMYK and RGB for data to be stored in the machine. Click the [Other Settings] button on the [Detailed Settings] tab and select the format from "Rip Style".
- To store a file in a custom folder, you must first create the custom folder using [Document Operations] in "Settings (administrator)" → [Document Filing]. If you have set a password for the custom folder, enter the password (5 to 8 digit number) in "PIN Code" on the stored to screen.



If you have configured to always use the force document filing function in "Printing Policy" on the [Configuration] tab, you cannot clear the [Document Filing] checkbox.

Mac OS

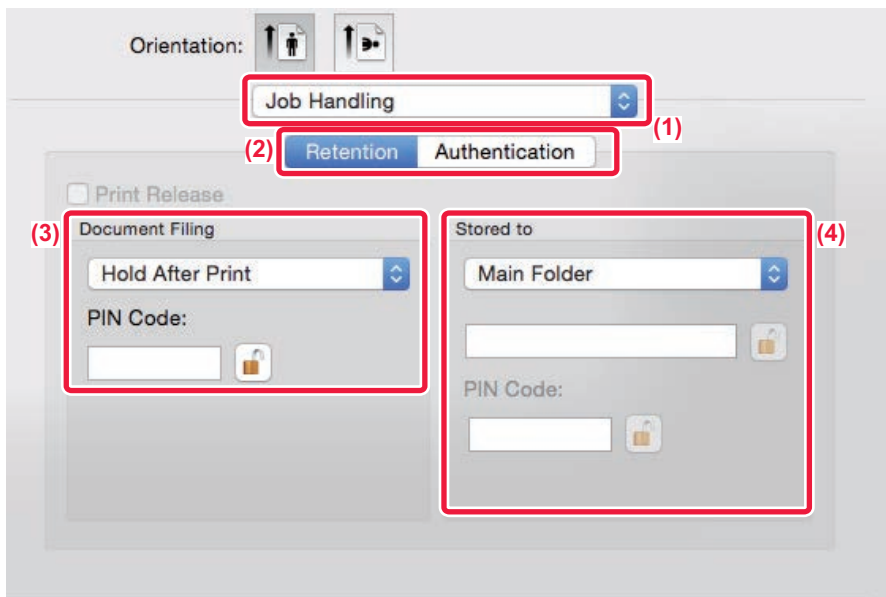

(1) Select [Job Handling].

(2) Select [Retention].

(3) Select how to save the print data in "Document Filing".

After you have entered a password (a 5 to 8-digit number), click the button to lock the password. This allows you to readily set the same password the next time you use it.

(4) Select the folder to store the file in "Stored To".

If you selected [Custom Folder], enter the name of the custom folder where you want to save the file.



- When [Quick File] is selected, "Document Filing" will be set to [Hold After Print].
- When [Quick File] is selected, the password entered in "Document Filing" is cleared.
- If necessary, you can select the data format from CMYK and RGB for data to be stored in the machine. Select [Advanced] in [Printer Features] and select the format from "Rip Style".
- To store a file in a custom folder, you must first create the custom folder using [Document Operations] in "Settings (administrator)" → [Document Filing]. If you have set a password for the custom folder, enter the password (5 to 8 digit number) in "PIN Code" on the folder selection screen.



AUTOMATICALLY PRINT ALL STORED DATA

When user authentication is enabled on the machine, all document filing (stored) print jobs of the user who logs in are automatically printed. After all jobs are printed, the stored jobs are deleted.



To use the Print All function, the following steps are necessary:

- In "Settings (administrator)", select [User Control] → [Default Settings] and enable [Automatically print stored jobs after login].
- When executing document filing print, in addition to the user authentication information, enter the user name stored in the machine in "User Name" of "Default Job ID" in the printer driver.
 - ▶ Using this function in a Windows environment: [PRINTING IN A WINDOWS ENVIRONMENT \(page 3-4\)](#)
 - ▶ Using this function in a Mac OS environment: [PRINTING IN A Mac OS ENVIRONMENT \(page 3-14\)](#)



Files with a password and files that are protected by the document filing function of the machine will not be printed. Files in a folder (excluding My Folder) that has a password will also not be printed.

(1) Select [Job Handling].

At the time of document filing print, in addition to the user authentication information, enter the user name stored in the machine in "User Name" in the printer driver.

(2) A confirmation prompt will appear. Tap the [OK] key.

The print files stored in the quick file folder, main folder, and custom folder will be printed automatically and then deleted.



PRINTING AND SENDING SIMULTANEOUSLY

This function prints data created in an application from the machine and simultaneously sends the data to the addresses stored in the machine.

This function allows you to complete two tasks, printing and sending, with one operation from the printer driver.



- Addresses must be stored in advance in the machine. For more information, see "[ADDRESS BOOK \(page 1-98\)](#)".
- You must complete the preparatory steps for using each sending function of the machine. For more information, see the explanation of each sending function.



- This function is available in a Windows environment.
- This function can be used when the PCL6 printer driver is used.
- You cannot print and send data simultaneously when [System Settings] in "Settings (administrator)" → [Printer Settings] → [Condition Settings] → [Disabling sending while printing] is selected.

Windows

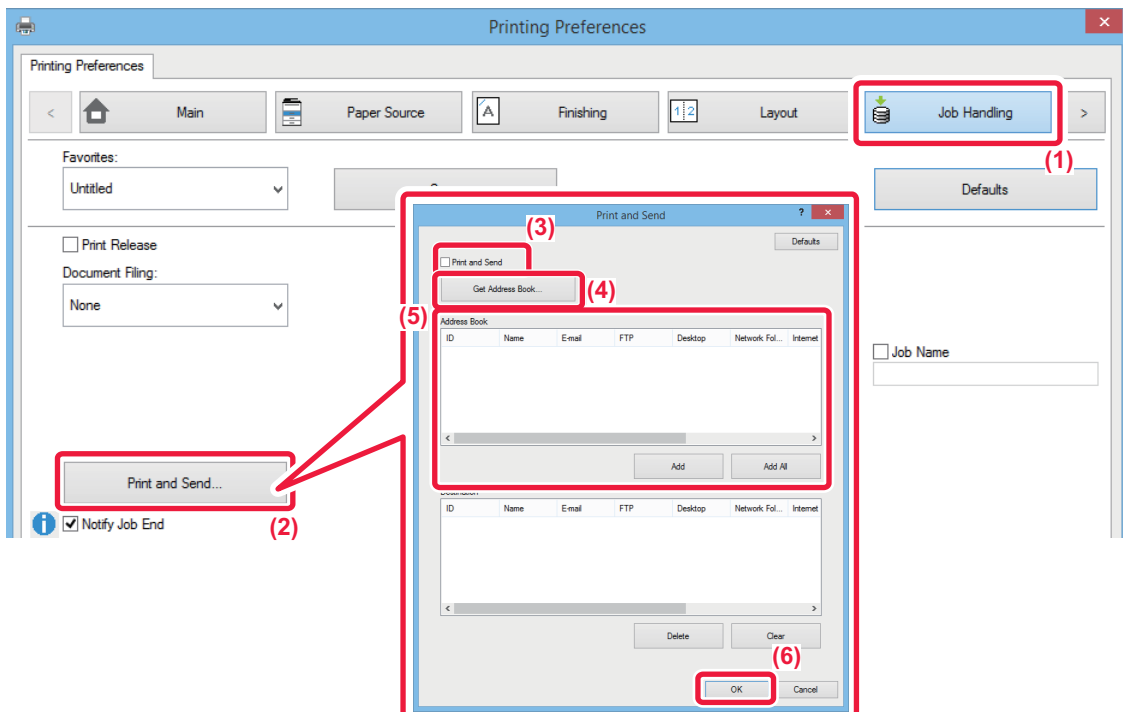

- (1) Click the [Job Handling] tab.
- (2) Click the [Print and Send] button.
- (3) Select the [Print and Send] checkbox so that appears.
- (4) Click the [Get Address Book] button.
- (5) From the "Address Book" list, select the address to which you wish to send the data, and click the [Add] button to add the address to the "Destination" list.
 - If you wish to send the data to all addresses, click the [Add All] button.
 - To delete an address from the "Destination" list, select the address and click the [Delete] button. If you wish to delete all addresses, click the [Delete All] button.



- Up to 50 destinations can be specified.
- Data cannot be sent to an Internet Fax address.

- (6) Click the [OK] button.

The printer driver settings are applied to sending settings.



PRINTING WITHOUT THE PRINTER DRIVER

EXTENSION OF PRINTABLE FILES

When you do not have the printer driver installed on your PC, or when the application used to open a file that you wish to print is not available, you can print directly to the machine without using the printer driver.

The file types (and corresponding extensions) that can be printed directly are shown below.

File Type	TIFF	JPEG	PNG	PCL	PS*1	PDF/ Encrypt PDF/ Compact PDF*1	DOCX, XLSX, PPTX*2
Extension	tiff, tif	jpeg, jpg, jpe, jfif	png	pcl, prn	ps, prn	pdf	docx, xlsx, pptx

*1 On the MX-2630N/MX-3050V/3550V/4050V/5050V/6050V, the PS3 expansion kit is required.

*2 On the MX-2630N/MX-3050V/3550V/4050V/5050V/6050V, the Direct print expansion kit is required.



- Even if the print result is black and white, the following types of print jobs will be counted as 4-color (Y (Yellow), M (Magenta), C (Cyan), and Bk (Black)) print jobs. When you want such jobs to be counted as black and white jobs, select the black and white printing option.
 - When the data is created as color data.
 - When the application treats the data as color data even though the data is black and white.
 - When an image is hidden under a black and white image.
- Some files may not print correctly even if shown in the above table.

DIRECTLY PRINTING A FILE ON AN FTP SERVER

When an FTP server is configured, you can directly select and print files on the FTP server from the touch panel of the machine. This function eliminates the need for downloading the files from the FTP server to your PC and sending print jobs from the PC to the machine.



To configure an FTP server:
In "Settings (administrator)", select [System Settings] → [Printer Settings] → [Direct Print Settings (FTP)]. (Administrator rights are required.) Up to 20 FTP servers can be configured.



When you select a PDF file that has a password, you must enter the password in the job status screen to begin printing.
▶ [PRINTING AN ENCRYPTED PDF FILE \(page 3-88\)](#)

1

Tap the [HDD File retrieve] key.



2

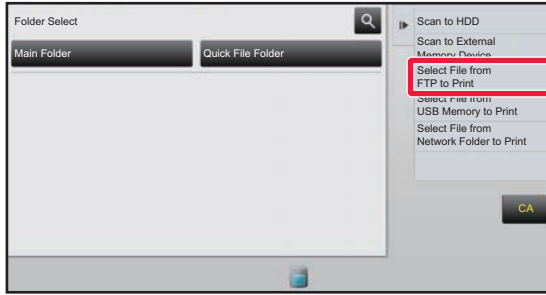

Tap the [Select File from FTP to Print] key on the action panel.



3

Tap the key of the FTP server that you wish to access.



When a server is selected, entry of a user name and password may be necessary. Enter your user name and password, and tap the [Enter] key.

4

Tap the key of the file that you wish to print, and tap the [Change Setting to Print] key on the action panel.

- When printing multiple files, tap the keys of the files you wish to print, and tap the [Print] key on the action panel.
- The  icon appears to the left of keys of files that can be printed.
- The  icon is displayed to the left of keys of folders on the FTP server. To display a folder or a file in a folder, tap this key.



- A total of 100 keys of files and folders can be displayed.
- Tap  to move up one folder level.
- When you move down a folder level by tapping a folder key,  appears. Tap this key to return to the file or folder name selection screen.
- Tap  to switch to thumbnails.
- Tap the [File or Folder Name] key to change the order of the files and folders displayed on the screen. Each time the key is tapped, the order changes between ascending and descending.

5

Select the print conditions.

- If you have selected multiple files in step 4, you can select only the number of prints.
- If you selected a PS or PCL file that includes print conditions in step 4, the print conditions in the file will be given priority.

6

Tap the [Start] key.

Printing begins after the selected file is downloaded.

“DirectOffice™ is a product of CSR Imaging US, LP.

DirectOffice™ is a trademark of CSR Imaging US, LP, registered in the United States and other countries, used with permission.”



DIRECTLY PRINTING A FILE IN USB MEMORY

Files in a USB memory device connected to the machine are printed from the operation panel of the machine without using the printer driver.

When the printer driver of the machine is not installed on your PC, you can copy a file into a commercially available USB memory device and connect the device to the machine to print the file directly.



- Use a FAT32 USB memory device with a capacity of no more than 32 GB.
- Printing from a USB memory device is not possible when [System Settings] in "Settings (administrator)" → [Printer Settings] → [Condition Settings] → [Disabling of USB Memory Direct Print] is selected.



When you select a PDF file that has a password, enter the password in the job status screen to begin printing.
▶ [PRINTING AN ENCRYPTED PDF FILE \(page 3-88\)](#)

1

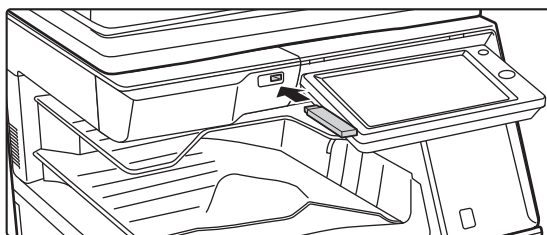

Connect the USB memory device to the machine.

2

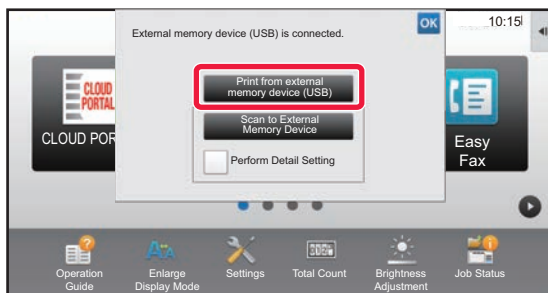

When the screen for selecting the action appears, tap [Print from external memory device (USB)].

If the screen does not appear, follow the steps below.

- (1) Tap the [HDD File retrieve] key.
- (2) Tap the [Select File from USB Memory to Print] key on the action panel.

3

Tap the key of the file that you wish to print, and tap the [Change Setting to Print] key on the action panel.

- When printing multiple files, tap the keys of the files you wish to print, and tap the [Print] key on the action panel.
- The icon appears to the left of keys of files that can be printed.
- The icon is displayed to the left of keys of folders in the USB memory device. To display a folder or a file in a folder, tap this key.



- A total of 100 keys of files and folders can be displayed.
- Tap to move up one folder level.
- When you move down a folder level by tapping a folder key, appears. Tap this key to return to the file or folder name selection screen.
- Tap to switch to thumbnails.
- Tap the [File or Folder Name] key to change the order of the files and folders displayed on the screen. Each time the key is tapped, the order changes between ascending and descending.



4

Select the print conditions.

- If you have selected multiple files in step 3, you can select only the number of prints.
- If you selected a PS or PCL file that includes print conditions in step 3, the print conditions in the file will be given priority.

5

Tap the [Start] key.

- Printing begins after the selected file is transferred.

6

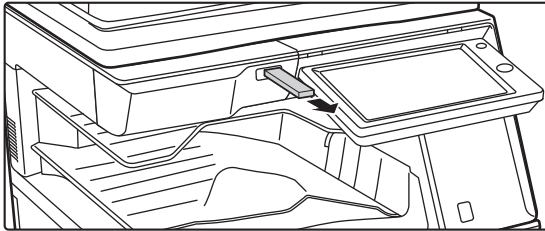

Remove the USB memory device from the machine.

DIRECTLY PRINTING A FILE IN A NETWORK FOLDER

You can specify and print a file in a network folder from the touch panel of the machine.

Even if the network folder is not registered, you can access the network folder by directly entering or referring to the path to the folder in the workgroup.



To register a network folder:

In "Settings (administrator)", select [System Settings] → [Printer Settings] → [Direct Print Settings (Network Folder)]. (Administrator rights are required.) Up to 20 network folders can be registered.



Printing from a network folder is not possible when [System Settings] in "Settings (administrator)" → [Printer Settings] → [Condition Settings] → [Disabling of Network Folder Direct Print] is selected.



When you select a PDF file that has a password, you must enter the password in the job status screen to begin printing.

► [PRINTING AN ENCRYPTED PDF FILE \(page 3-88\)](#)

Printing a file in the network folder you have configured in the machine's settings

1

Tap the [HDD File retrieve] key.

2

Tap the [Select File from Network Folder to Print] key on the action panel.



3

Tap the [Open Registered Network Folder.] key on the action panel and tap the network folder that you wish to access.



If a screen appears prompting you to enter a user name and password, check with your server administrator and enter the appropriate user name and password.





- When you tap the [Direct Input of Folder Path] key, a screen appears to allow direct input of the network folder path. For more information, see "[Entering the network folder path directly \(page 3-85\)](#)".
- When you select the workgroup, server, and network folder in sequence, you can access the network folder. For more information, see "[Referring to the network folder path \(page 3-85\)](#)".

4

Tap the key of the file that you wish to print, and tap the [Change Setting to Print] key on the action panel.

- When printing multiple files, tap the keys of the files you wish to print, and tap [Print] on the action panel.
- The  icon appears to the left of keys of files that can be printed.
- The  icon is displayed to the left of keys of folders in the network folder. To display a folder or a file in a folder, tap this key.



- A total of 100 keys of files and folders can be displayed.
- Tap  to move up one folder level.
- To return to the network folder selection screen, tap .
- Tap  to switch to thumbnails.
- Tap the [File or Folder Name] key to change the order of the files and folders displayed on the screen. Each time the key is tapped, the order changes between ascending and descending.

5

Select the print conditions.

- If you have selected multiple files in step 4, you can select only the number of prints.
- If you selected a PS or PCL file that includes print conditions in step 4, the print conditions in the file will be given priority.

6

Tap the [Start] key.

Printing begins after the selected file is transferred.



Entering the network folder path directly

1

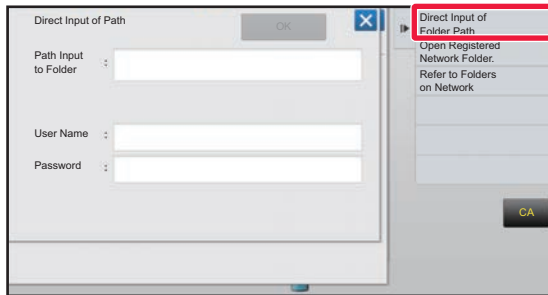

Tap [Direct Input of Folder Path] in step 3 of "[Printing a file in the network folder you have configured in the machine's settings \(page 3-83\)](#)".

2

Enter the path to the folder, user name and password.

Access the network folder.

For the procedure for printing, see steps 4 to 6 of "Printing a file in the network folder you have configured in the machine's settings".

Referring to the network folder path

1

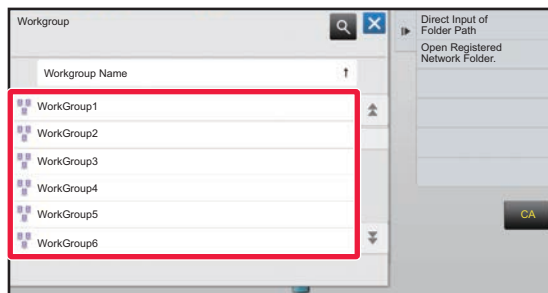

Tap the key of the workgroup that you wish to access in step 3 of "[Printing a file in the network folder you have configured in the machine's settings \(page 3-83\)](#)".

2

Tap the key of the server or computer that you wish to access.

If a screen appears prompting you to enter a user name and password, check with your server administrator and enter the appropriate user name and password.

3

Tap the key of the network folder that you wish to access.

Access the network folder.

For the procedure for printing, see steps 4 to 6 of "[Printing a file in the network folder you have configured in the machine's settings \(page 3-83\)](#)".



- Tap the icon and enter a keyword to search for a workgroup, server, or network folder. To enter text, see "[NAMES AND FUNCTIONS OF SOFT KEYBOARD KEYS \(page 1-165\)](#)".
- Up to 100 workgroups, 100 servers, and 100 network folders are displayed.
- Tap to move up one folder level.
- To return to the workgroup selection screen, tap .



DIRECTLY PRINTING FROM A COMPUTER

SUBMIT PRINT JOB

By selecting [Document Operations] → [Submit Print Job] from "Settings (Web version)" and specifying a file, you can directly print the file without using the printer driver.

In addition to a file on your PC, this procedure can be used to print any file that can be accessed from your PC, such as a file on another PC connected to the same network.

For the procedure for accessing the "Settings (Web version)", see "[SETTING MODE \(page 7-3\)](#)".



- If you selected a PS or PCL file that includes print conditions, the print conditions in the file will be given priority.
- When user authentication is enabled in the settings of the machine, the print function may be restricted. For more information, ask your administrator.

FTP PRINT

You can print a file from your PC by simply dragging and dropping the file onto the FTP server of the machine.



To perform FTP print:

In "Settings (administrator)", select [System Settings] → [Printer Settings] → [Print Setting from PC/Mobile Terminal], set [FTP Print] to [Enable], and then configure the port number. (Administrator rights are required.)

Performing FTP print

Type "ftp://" and then the IP address of the machine in the address bar of your PC's Web browser as shown below.

Example: ftp://192.168.1.28

Drag and drop the file that you wish to print onto the "lp" folder that appears in your Web browser. Printing of the file automatically begins.



- If you selected a PS or PCL file that includes print conditions, the print conditions in the file will be given priority.
- When user authentication is enabled in the settings of the machine, the print function may be restricted. For more information, ask your administrator.

E-MAIL PRINT

If you configure your e-mail account in the machine, the machine periodically checks your mail server and automatically prints received e-mail attachments without using the printer driver.



To perform e-mail print:

In "Settings (administrator)", select [System Settings] → [Printer Settings] → [E-mail Print Settings], and register your e-mail account. (Administrator rights are required.)



Performing e-mail print

Using your PC's e-mail software, specify the e-mail address of the machine in "Address" and send e-mail attached with a file to be printed.

Control commands can be entered in the message of the e-mail to specify the number of copies and print format. Commands are entered in the format "command name = value" as shown in the example to the right.

```
COPIES=2
DUPLEX=LEFT
ACCOUNTNUMBER=11111
PAPER=A4
B/W PRINT=ON
```

As an example, the control commands include the following:

Function	Command name	Values
Copies	COPIES	1 to 9999
Staple*1	STAPLEOPTION	NONE, ONE, TWO, SADDLE, STAPLELESS
Punch*2	PUNCH	OFF, ON
Collate	COLLATE	OFF, ON
2-sided Print	DUPLEX	TOP, LEFT, RIGHT, OFF
Account Number*3	ACCOUNTNUMBER	Number (5 to 8 digits)
File Format*4	LANGUAGE	PCL, PCLXL, POSTSCRIPT, PDF, TIFF, JPG, DOCX, XLSX, PPTX, PNG
Paper	PAPER	Paper that can be used (A4, LETTER, or others)
Fold	V-FOLD	OFF, INSIDE, OUTSIDE
Document Filing*5	FILE	OFF, ON
	FOLDERNAME	Up to 28 characters
Quick File*5	QUICKFILE	OFF, ON
Output	OUTTRAY	CENTER, RIGHT, FINISHER
B/W Print	B/W PRINT	OFF, ON
Fit Page	FITIMAGETOPAGE	OFF, ON
Print Glossy	MEDIATYPE	GLOSSY
Print Pages	PRINTPAGES	1-2,5,9-

*1 Enabled only when an inner finisher, finisher, finisher (large stacker), saddle stitch finisher or saddle stitch finisher (large stacker) is installed. "STAPLELESS" is only enabled when an inner finisher, finisher (large stacker) or saddle stitch finisher (large stacker) that allows stapling without staples is installed.

*2 Enabled only when a punch module is attached to the inner finisher, finisher, finisher (large stacker), saddle stitch finisher or saddle stitch finisher (large stacker).

*3 Can be omitted except when authentication is by user number.

*4 On the MX-2630N/MX-3050V/MX-3550V/MX-4050V/MX-5050V/MX-6050V, the Direct print expansion kit is required for DOCX, PPTX, and XLSX files.

*5 Only enabled when either "Document Filing" or "Quick File" is "ON". When both are "ON", this is disabled.



- The mail text must be in a text format. If entered in Rich Text format (HTML), the commands will have no effect.
- If you enter "Config" in the mail text, a list of control commands is returned.
- If nothing is entered in the body text (message) of the e-mail, printing will take place according to the settings configured in "Settings (administrator)." → [System Settings] → [Printer Settings] → [Initial Status Settings]. If you selected a PS or PCL file that includes print conditions, the print conditions in the file will be given priority.
- Enter a file type only when you wish to specify the page-description language. Normally there is no need to enter a file type.



PRINTER JOBS

CHECKING THE PRINT STATUS

When you tap the job status display, jobs are displayed in a list. To check the status of a printer job, tap the [Print] tab. When you wish to stop or delete jobs or to perform priority processing, read the following items:

- [STOPPING/DELETING A JOB IN PROGRESS OR RESERVED \(page 1-90\)](#)
- [PRIORITY PROCESSING OF A RESERVED JOB \(page 1-91\)](#)
- [CHECKING A RESERVED JOB OR THE JOB IN PROGRESS \(page 1-93\)](#)
- [CHECKING COMPLETED JOBS \(page 1-94\)](#)

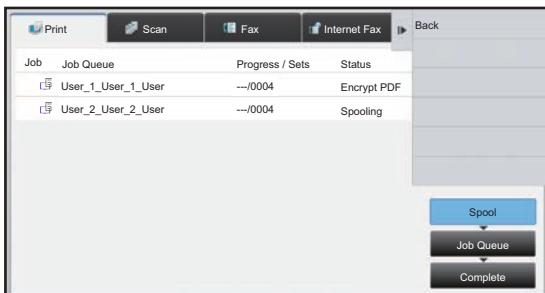

PRINTING AN ENCRYPTED PDF FILE

PDF encryption is used to protect a PDF file by requiring the entry of a password to print or edit the file. To directly print an encrypted PDF file on an FTP server or in a USB memory device, etc. connected to the machine, reset the password and begin printing.



- To print an encrypted PDF file using the printer driver, enter the password when opening the file on your PC.
- Printing is not possible if you do not know the password for the encrypted PDF file.
- Encrypted PDF versions that can be directly printed are 1.6 (Adobe® Acrobat® 7.0) and earlier.

(1) Tap the Job status display and tap the [Print] tab.

(2) Tap the [Spool] key.

When the list contains an encrypted PDF file, a message is displayed to indicate that an encrypted PDF file exists.

(3) Tap the print job key for the encrypted PDF file.



You cannot select multiple encrypted PDF files.

(4) Tap the [Enter Password for Encrypt PDF.] key on the action panel.

(5) Enter the password (32 characters or less) and tap the [Yes] key.



When both a master password and a user password (which is used to open the file) have been set, enter the master password.



CHANGING TO ANOTHER PAPER SIZE AND PRINTING WHEN PAPER RUNS OUT

If printing stops because the machine ran out of paper, or if the size of paper specified in the printer driver is not loaded in the machine, a message will appear in the touch panel.

Printing will begin automatically when paper is loaded in the machine. If paper of the desired size is not immediately available, you can use paper that is set in a different tray.



If you changed to a different paper size, printing may not take place correctly; for example part of the text or image may run off the paper.

- (1) Tap the job status display.
- (2) Tap the key of the job for which "Paper Empty" appeared.
- (3) Tap the [Reselect Paper] key on the action panel.
- (4) Tap the key for the tray containing the paper that you wish to use, and tap **OK** .



APPENDIX

PRINTER DRIVER SPECIFICATIONS LIST

For information on the setting items, refer to printer driver Help.

[PRINTER DRIVER SETTINGS SCREEN / REFERRING TO HELP \(page 3-6\)](#)

Function			PCL6	PS	Windows PPD*1	Mac OS PPD*1
Tab (Windows)	Item	Page				
Main	Copies	-	1 - 9999	1 - 9999	1 - 9999	1 - 9999
	Collate	-	Yes	Yes	Yes	Yes
	Original Size	3-4	Yes	Yes	Yes	Yes
	Output Size	3-4	Yes	Yes	Yes	Yes
	Orientation	3-36	Yes	Yes	Yes	Yes
	Adjust to Paper Size	3-23	Yes	Yes	No	Yes
	Zoom	3-37	Yes*2	Yes	Yes*2	Yes*2
	2-Sided	3-22	Yes	Yes	Yes	Yes
	N-Up	3-25	2, 4, 6, 8, 9, 16	2, 4, 6, 8, 9, 16	2, 4, 6, 9, 16	2, 4, 6, 9, 16
	Staple *3	3-28	Yes	Yes	Yes	Yes
	Document Filing	3-76	Yes	Yes	No	Yes
	Color Mode	3-19	Yes	Yes	Yes	Yes
Paper Source	Output Size	3-4	Yes	Yes	Yes	Yes
	Paper Tray	3-7	Yes	Yes	Yes	Yes
	Paper Type	3-7	Yes	Yes	Yes	Yes
	Tray Status	3-7	Yes	Yes	No	No
Finishing	Staple *3 Saddle Stitch *4	3-28	Yes	Yes	Yes	Yes
	Punch *3	3-28	Yes	Yes	Yes	Yes
	Fold *4	3-65	Half Fold	Half Fold	Half Fold	Half Fold
	Offset	-	Yes	Yes	Yes	Yes
	Output	-	Yes	Yes	Yes	Yes
	Separator Page	3-59	Yes	Yes	No	No



Function			PCL6	PS	Windows PPD*1	Mac OS PPD*1	
Tab (Windows)	Item	Page					
Layout	2-Sided		3-22	Yes	Yes	Yes	Yes
	Chapter Inserts		3-64	Yes	No	No	No
	Booklet		3-30	Yes	Yes	Yes	Yes
	N-Up	Page No.	3-25	2, 4, 6, 8, 9, 16	2, 4, 6, 8, 9, 16	2, 4, 6, 9, 16	2, 4, 6, 9, 16
		Repeat	3-68	Yes	No	No	No
		Order	3-25	Yes	Yes	No	Yes
		Border	3-25	Yes	Yes	No	Yes
		N-Up with cover	3-25	Yes	No	No	No
		100% N-Up	3-25	Yes	Yes	No	No
	Poster Printing		3-34	Yes	Yes	No	No
	Print Position	Margin Shift	3-32	10mm to 30mm (0 inch to 1.2 inch)	10mm to 30mm (0 inch to 1.2 inch)	Yes	Yes
Tab Shift		3-61	Yes	Yes	No	No	
Custom		3-35	Yes	Yes	No	No	
Job Handling	Print Release		-	Yes	Yes	No	Yes
	Document Filing		3-76	Yes	Yes	No	Yes
	Create PDF for PC Browsing		3-76	Yes	No	No	No
	Print and Send		3-79	Yes	No	No	No
	Notify Job End		-	Yes	Yes	No	No
	Authentication		3-9	Yes	Yes	No	Yes
Inserts	Covers/Inserts		3-55	Yes	Yes	Yes*5	Yes*5
	Transparency Inserts		3-57	Yes	Yes	No	Yes
	Carbon Copy		3-60	Yes	Yes	No	No
	Tab Paper		3-61	Yes	No	No	No
Stamp	Watermark		3-48	Yes	Yes	Yes	Yes
	Image Stamp		3-50	Yes	Yes	No	No
	Overlay		3-52	Yes	Yes	No	No
	Hidden Pattern		3-69	Yes	No	No	No
	Copies Stamp		3-54	Yes	No	No	No
Image Quality	Print Mode		3-21	Yes	Yes	Yes	Yes
	Graphics Mode		-	Yes	No	No	No
	Bitmap Compression		-	Yes	Yes	No	No
	Sharpness		3-45	Yes	Yes	Yes	Yes
	Screening		3-45	Yes	Yes	Yes	Yes
	Smoothing		3-73	Yes	Yes	No	Yes
	Text To Black		3-44	Yes	Yes	No	No



Function			PCL6	PS	Windows PPD*1	Mac OS PPD*1
Tab (Windows)	Item	Page				
Image Quality	Vector To Black	3-44	Yes	Yes	No	No
	Toner Save *6	-	Yes	Yes	Yes	Yes
	Color Mode	3-19	Yes	Yes	Yes	Yes
	Image Type	3-45	Yes	Yes	No	Yes
	Advanced Color	3-45	Yes	Yes	No	Yes
	Color Adjustment/ RGB Adjustment	3-42	Yes	Yes	No	No
	Font	-	Yes	Yes	No	No
	Line Width	3-39	Yes	No	No	No
Detailed Settings	Mirror Image	3-41	No	Yes	Yes	Yes
	PS Error Information	-	No	Yes	Yes	No
	PS Pass-Through	-	No	Yes	No	No
	Job Compression	-	No	Yes	No	No
	Tandem Print	3-74	Yes	Yes	No	Yes*7
	Disable Blank Page Print	3-27	Yes	Yes	No	No
	Custom Image Registration	3-51	Yes	No	No	No
	Other Settings					
	• Input Resolution	-	Yes	Yes	No	No
	• Shade Pattern	-	Yes	No	No	No
	• Spool Data Format	-	Yes	Yes	No	No
	• Printable Area	3-72	Yes	Yes	No	No
	• Rip Style	3-76	Yes	Yes	No	Yes
	• Duplex Style	3-22	Yes	Yes	No	No
	• Job Name Shortening	-	Yes	Yes	No	No
	• Use driver to render JPEGs	3-71	Yes	Yes	No	No
	• Expand	-	Yes	Yes	Yes	Yes
• Thicken Fine Lines	3-40	Yes	No	No	No	
• Fine Text	-	Yes	Yes	Yes	Yes	
• Fine Edge	-	No	Yes	Yes	Yes	

*1 The specifications of each function in Windows PPD and Mac OS PPD vary depending on the operating system version and the application.

*2 The horizontal and vertical proportion cannot be set separately.

*3 If a finisher or a saddle stitch finisher is installed (The punch module is also required in order to use the punch function.)

*4 If a saddle stitch finisher is installed

*5 Only covers can be inserted.

*6 This setting may not operate in some applications and operating systems.

*7 This function cannot be used in Mac OS X 10.10 or later.



SPECIFYING A BILLING CODE USING THE PRINTER DRIVER

You can enter a billing code using the printer of the machine.
For an overview of a billing code, refer to "[BILLING CODE \(page 1-40\)](#)".

Enable billing code

This setting is required only in the Windows environment. (Always usable under Mac OS environment)

1

Right-click the [Start] button and select [Control Panel].



In Windows 7, click the [Start] button, select [Devices and Printers], right-click the printer driver icon of the machine, and click [Printer Properties].

2

Click [View devices and printers] in [Hardware and Sound].

3

Click [Printer Properties].

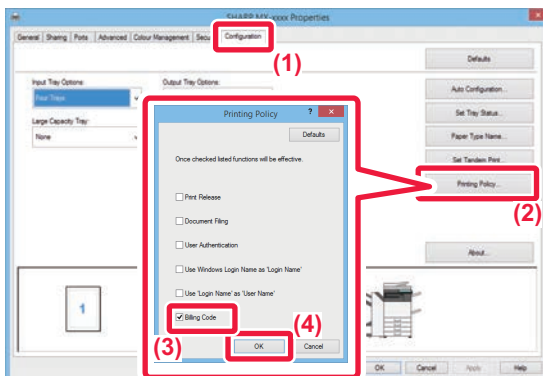
4

Specify a billing code

- (1) Click the [Configuration] tab.
- (2) Click the [Printing Policy] button.
- (3) Set the [Billing Code] check box to ,
- (4) Click the [OK] button.



Windows

When printing starts, the billing code setting screen appears.

Enter the main code and sub code, and click the [OK] button.

To retain the specified billing code, set [Always Use This Billing Code] to .

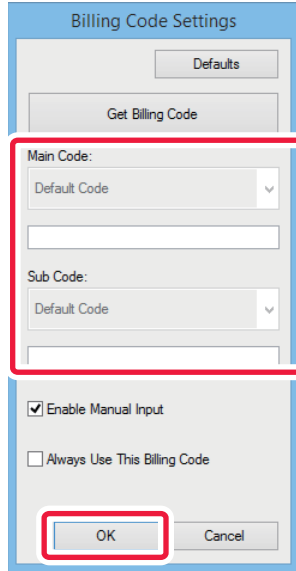

- You can click [Get Billing Code] to get the machine's billing code list and select the billing code from the list.
- If [Use Billing Code] is set to "Disable" in "Settings (administrator)" - [Billing Code Setting] - [Administration Settings], the entered billing code is disabled and is not recorded in the job log.
- If you have started printing without specifying a billing code, a use code is recorded in the job log.

Mac OS

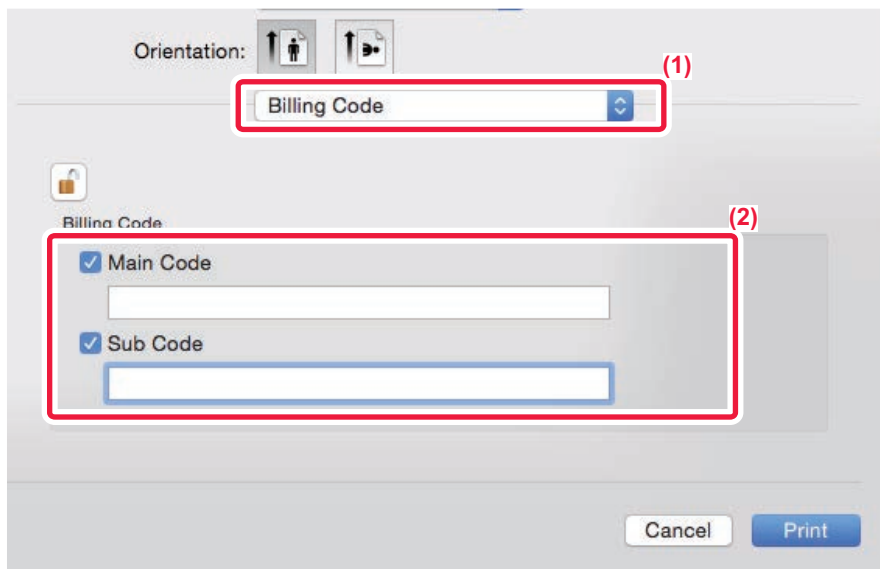

(1) Select [Billing Code].

(2) Enter the main code and sub code.



AUTHENTICATION BY SINGLE SIGN-ON

When the user authentication is used, you must enter your user name and password to print from a printer driver. The Single Sign-on function can be used when Active Directory authentication is used on both the machine and the computer.

When you use this function and print from the printer driver, the print job is sent to the machine using the authentication information that you used to log in to the computer. This allows easy printing of jobs from the printer driver without the need to enter your user name or password each time you print when user authentication is enabled.



Authentication by Single Sign-on requires that Active Directory authentication be performed on the machine and your computer. This can only be used when your computer is running Windows.

Settings

Active Directory must be enabled on the machine in advance. For information on Active Directory, refer to "[ACTIVE DIRECTORY LINKING FUNCTION \(page 1-37\)](#)". After enabling Active Directory, configure the settings below in the printer driver.

- (1) **Right-click on the Start window (or swipe up from the lower end of the window), and click the App Bar → [All apps] → [Control Panel] → [Hardware and Sound] → [Devices and Printers].**
In Windows 7/Server 2008, click the [Start] button → [Control Panel] → [Hardware and Sound] → [Devices and Printers].
- (2) **Right-click the machine's printer driver icon and select [Printer Properties].**
The printer properties appear.
- (3) **Click the [Configuration] tab.**
- (4) **Set the [Single Sign-on] checkbox to .**

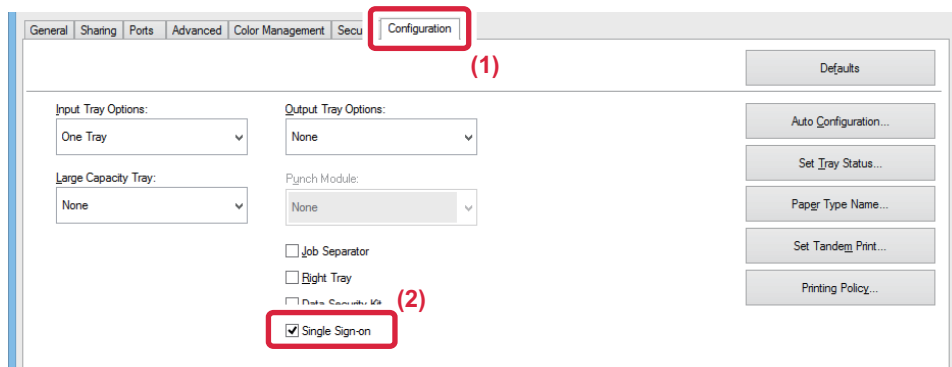

Authentication Option

For the authentication method, refer to "[PRINTING WHEN THE USER AUTHENTICATION FUNCTION IS ENABLED \(page 3-9\)](#)".

- (1) **Click the [Job Handling] tab.**
- (2) **In [Authentication], select [Single Sign-on].**



- Single Sign-on authentication is also possible from the Job Handling dialog box and the User Authentication dialog box.
- When Single Sign-on is enabled, [Print and Send] cannot be used.
- If you logged in to the machine in advance before using Single Sign-on, you will have the permissions of the user account you used to log in.
If you use Single Sign-on without logging in to the machine, the user permissions will be those of "User". This may limit the functions that you can use.
- If Single Sign-on is used without logging in to the machine, the user name in the job log will be the name set by printer driver. If the user name is not set by printer driver, the user name in the job log will be the computer login name.



PRINTING BY GOOGLE CLOUD PRINT

Google Cloud Print is a printing service that lets you print a file in a PC, mobile device, or other client via the Cloud server operated by Google Inc. on a printer that is connected to Cloud server.

Configure settings for connection of the machine to the Internet (proxy settings, etc.) as required for your network environment.

The procedure for printing by Google Cloud Print is explained here.

Before using this function, you must first create a Google account.



On the MX-2630N/MX-3050V/MX-3550V/MX-4050V/MX-5050V/MX-6050V, the PS3 expansion kit is required to use Google Cloud Print.

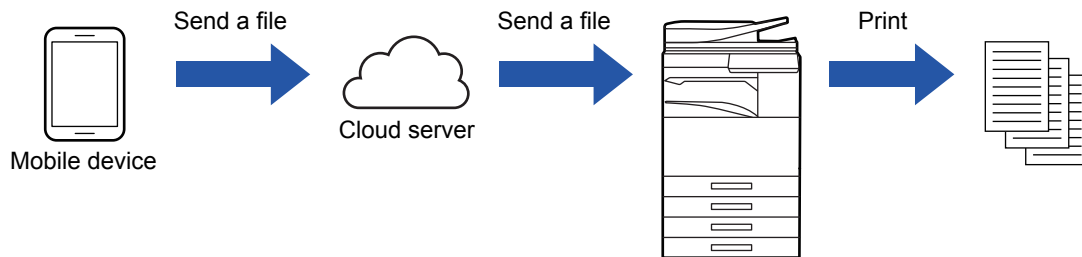

Settings on the machine

Before using this function, configure the settings below in "Settings (administrator)".

- If the machine's user authentication function is enabled, turn off "Settings (administrator)" - [User Control] - [Default Settings] - [Disable Printing by Invalid User].
- To print in colour, you must change the permission of "Other User" to a permission that allows colour printing.
- If user authentication is enabled in the Sharp OSA application, allow printing by invalid users in the application.
- Configure the following settings in "Settings (administrator)" → [System Settings] → [Network Settings] so that they match the settings in Google Cloud Print.
 - IP address, subnet mask, default gateway
 - IP address of DNS server
 - Proxy server settings
- Configure the machine settings in the Google Cloud Print settings. For the Google Cloud Print settings, refer to "[Google Cloud Print Settings \(page 7-144\)](#)".



Print settings

You can print from an application that supports Google Cloud Print. Functions that can be enabled from the application are as follows.

Item	Description
Print Colour	Auto, Black & White, Colour
2-Sided Print	None, Book, Tablet
Orientation	Portrait, Landscape
Copies	1-999
Resolution	600x600, 1200x1200*1
Fit Page	On, Off
Page Select	-
Paper Size	A4, A3, A5, B4, B5, A3W, Ledger, Legal, Letter, Invoice, Executive, Foolscap, 8 1/2 x 13 2/5, 216 x 343, 8K, 16K
Paper Tray	Varies depending on the machine configuration
Output Tray	Centre Tray, Right Tray, Upper Tray, Middle Tray, Lower Tray
Print per Unit	On, Off
Staple*2	On, Off

*1 This item cannot be used in MX-2630N.

*2 Can be used when an inner finisher, finisher, or saddle stitch finisher is installed.



- Google Cloud Print uses the XMPP (5222) port or HTTPS (443) port for communication. Check the settings for restriction of access from the Internet, the machine administrator password, and mDNS as needed.
- In some cases the print quality using Google Cloud Print may not be the same as the print quality using other print methods (printer driver, etc.).
The content of some files may not print correctly or may not be printable.
- In some countries and regions, the machine may not be able to use some or all of the Google Cloud Print connection functions.
- In some network environments, the machine may not be able to use the Google Cloud Print connection functions, or printing may be slow or may stop before the job is completed.
- Sharp Corporation does not in any way guarantee the continuity or stability of Google Cloud Print connection functions. With the exception of instances provided for by law, Sharp Corporation bears no responsibility for any damages or loss due to the customer's use of these functions.



FACSIMILE







Icons

 Functions you can use in Easy Fax mode





BEFORE USING THE MACHINE AS A FAX



BEFORE USING THE MACHINE AS A FAX	4-4
FAX MODE	4-7
 • EASY MODE	4-7
• NORMAL MODE	4-8
SELECTING FAX MODE	4-8
[R] KEY	4-10
FAX TRANSMISSION SEQUENCE	4-11

ENTERING DESTINATIONS





 ENTERING DESTINATIONS	4-13
 • ENTERING A DESTINATION NUMBER USING THE NUMERIC KEYS	4-13
 • RETRIEVING A DESTINATION FROM AN ADDRESS BOOK	4-14
 • THE SELECTED DESTINATIONS	4-16
• USING A SEARCH NUMBER TO RETRIEVE A DESTINATION	4-17
 • RETRIEVING A DESTINATION FROM A GLOBAL ADDRESS BOOK	4-18
 • USING A TRANSMISSION LOG TO RESEND	4-20
 • SENDING BY CHAIN DIALLING	4-22

BASIC TRANSMISSION METHODS

 BASIC TRANSMISSION METHODS	4-23
 • FAX TRANSMISSION METHODS	4-23
 • ORIGINAL ORIENTATION	4-25
• AUTOMATIC REDUCTION OF THE TRANSMITTED IMAGE	4-26
• TRANSMITTABLE ORIGINAL SIZES	4-26
• THE SIZE OF THE PLACED ORIGINAL	4-27
• WHEN THE LINE IS BUSY	4-28
• WHEN A COMMUNICATION ERROR OCCURS	4-28
• FAX DEST. CONFIRMATION MODE	4-29
• CHECKING THE IMAGE TO BE TRANSMITTED	4-30
 FAX TRANSMISSION METHODS	4-30
 • USING THE AUTOMATIC DOCUMENT FEEDER FOR TRANSMISSION	4-30

• USING THE AUTOMATIC DOCUMENT FEEDER FOR FAXING IN DIRECT TX MODE	4-31
 • USING THE DOCUMENT GLASS FOR TRANSMISSION	4-33
• USING THE DOCUMENT GLASS TO SEND A FAX IN DIRECT TX MODE	4-35
• TRANSMISSION USING THE SPEAKER	4-37
 • SENDING THE SAME FAX TO MULTIPLE DESTINATIONS (BROADCAST TRANSMISSION)	4-38
• RESENDING TO UNSUCCESSFUL BROADCAST TRANSMISSION DESTINATIONS	4-40
• SENDING A FAX DIRECTLY FROM A COMPUTER (PC-Fax)	4-42

DELETING A TRANSMISSION LOG 4-43

 SET THE SCANNING OF THE ORIGINALS	4-45
 • AUTOMATICALLY SCANNING BOTH SIDES OF AN ORIGINAL (2-Sided Original)	4-45
• AUTO DETECTION	4-46
• SPECIFYING THE ORIGINAL SCAN SIZE IN PAPER SIZE	4-47
• SPECIFYING THE ORIGINAL SCAN SIZE USING NUMERIC VALUES	4-48
• STORING FREQUENTLY USED ORIGINAL SIZES	4-49
• SPECIFYING THE SEND SIZE OF THE IMAGE	4-52
 • CHANGING THE EXPOSURE	4-54
 • CHANGING THE RESOLUTION	4-55

FAX RECEPTION

RECEIVING A FAX	4-56
• RECEIVING A FAX AUTOMATICALLY	4-56
 • RECEIVING A FAX MANUALLY	4-58
PRINTING RECEIVED DATA	4-59
• PRINTING A PIN CODE-PROTECTED FAX (Hold setting for received data print)	4-59
• PRINTING RECEIVED DATA AT A SPECIFIED TIME	4-60
• CHECKING THE IMAGE BEFORE PRINTING	4-61
FORWARDING RECEIVED DATA	4-63
• FORWARDING RECEIVED FAXES (FAX DATA FORWARD)	4-63





- FORWARDING RECEIVED DATA TO PRESET DESTINATIONS (INBOUND ROUTING SETTINGS) 4-64
- SAVING RECEIVED FAXES TO THE MACHINE'S HARD DISK (INBOUND ROUTING) 4-68
- FORWARDING RECEIVED DATA MANUALLY 4-69

SAVING RECEIVED DATA 4-71

OTHERS FUNCTION

STORING FAX OPERATIONS (PROGRAM) 4-72

SENDING ORIGINALS COLLECTIVELY 4-74

- SENDING TWO PAGES AS A SINGLE PAGE (N-UP) 4-74
- SENDING BOTH SIDES OF A CARD AS A SINGLE PAGE (CARD SHOT) 4-76
- SENDING A LARGE NUMBER OF PAGES (JOB BUILD) 4-78
- SENDING ORIGINALS OF DIFFERENT SIZES (MIXED SIZE ORIGINAL) 4-80

SENDING AN ORIGINAL AS SEPARATE PAGES 4-82

- SENDING AN ORIGINAL AS TWO SEPARATE PAGES (DUAL PAGE SCAN) 4-82
- SPLITTING A PAMPHLET BY PAGE AND TRANSMITTING THE PAGES SUCCESSIVELY (BOOK DIVIDE) 4-84

SCANNING ORIGINALS 4-86

- ERASING PERIPHERAL SHADOWS ON THE IMAGE (ERASE) 4-86
- SENDING A THIN ORIGINAL (SLOW SCAN MODE) 4-89
- CHECKING THE NUMBER OF SCANNED ORIGINAL SHEETS BEFORE TRANSMISSION (ORIGINAL COUNT) 4-91
- STAMPING SCANNED ORIGINALS (VERIFICATION STAMP) 4-93

OPERATING FAX TRANSMISSION AND RECEPTION REMOTELY 4-94

- CALLING A FAX MACHINE AND INITIATING RECEPTION (POLLING) 4-94
- INITIATING POLLING RECEPTION MANUALLY 4-96

SENDER-RELATED FEATURES 4-97

- ADDING YOUR SENDER INFORMATION TO FAXES (FAX OWN NUMBER SENDING) 4-97
- TEMPORARILY CHANGING THE SENDER INFORMATION (OWN NAME SELECT) 4-98

ASSUMING A SPECIFIC USAGE 4-100

- SPECIFYING THE TIME FOR COMMUNICATION 4-100
- CHANGING THE PRINT SETTINGS FOR THE TRANSACTION REPORT (TRANSACTION REPORT) 4-102

POLLING MEMORY FUNCTIONS 4-104

- SENDING A FAX WHEN ANOTHER MACHINE POLLS YOUR MACHINE (POLLING MEMORY) 4-104
- RESTRICTING POLLING ACCESS (POLLING SECURITY SETTING) 4-104
- SCANNING A DOCUMENT INTO POLLING MEMORY 4-105
- CHECKING THE DOCUMENT IN THE PUBLIC BOX 4-106
- DELETING A DOCUMENT FROM THE PUBLIC BOX 4-107

PERFORMING F-CODE COMMUNICATION

F-CODE COMMUNICATION 4-108

- F-CODE COMMUNICATION 4-108
- CREATING MEMORY BOXES IN THE MACHINE FOR F-CODE COMMUNICATION 4-109
- F-CODE DIALLING 4-110
- F-CODE CONFIDENTIAL TRANSMISSION 4-110
- CONFIDENTIAL TRANSMISSION USING F-CODES 4-111
- CHECKING FAXES RECEIVED BY F-CODE CONFIDENTIAL RECEPTION 4-112
- POLLING RECEPTION USING F-CODES 4-113
- SCANNING A DOCUMENT INTO A MEMORY BOX FOR F-CODE POLLING TRANSMISSION 4-115
- CHECKING THE DOCUMENT IN THE F-CODE MEMORY POLLING BOX 4-117
- DELETING A DOCUMENT STORED FOR F-CODE POLLING TRANSMISSION 4-118
- RELAY REQUEST TRANSMISSION USING F-CODES 4-119
- RELAY BROADCAST TRANSMISSION USING F-CODES 4-121





USING AN EXTERNAL TELEPHONE

CONNECTING AN EXTERNAL TELEPHONE 4-122

- CONNECTING AN EXTENSION TELEPHONE . . . 4-122
- RECEIVING A FAX AFTER ANSWERING A CALL ON THE EXTENSION TELEPHONE (REMOTE RECEPTION) 4-123
- MAKING AND RECEIVING PHONE CALLS . . . 4-123

CHECK THE COMMUNICATION STATUS

FAX JOBS 4-124

COMPLETED FAX TRANSMISSION/RECEPTION JOBS 4-124

CHECKING IMAGE SENDING ACTIVITIES 4-125

- PRINTING IMAGE SENDING ACTIVITY REPORTS 4-125
- INFORMATION APPEARING IN THE RESULT COLUMN 4-125



BEFORE USING THE MACHINE AS A FAX



The facsimile expansion kit is required in order to make use of fax functionality.

BEFORE USING THE MACHINE AS A FAX

To use the machine as a facsimile, connect the telephone line, and set the telephone line type.

1

Connecting to the telephone line.

Insert the plug on one end of the telephone line cord into the telephone line socket (LINE) of the machine as shown, and insert the other plug into a wall telephone socket.

* Be sure to use the attached telephone line cord.

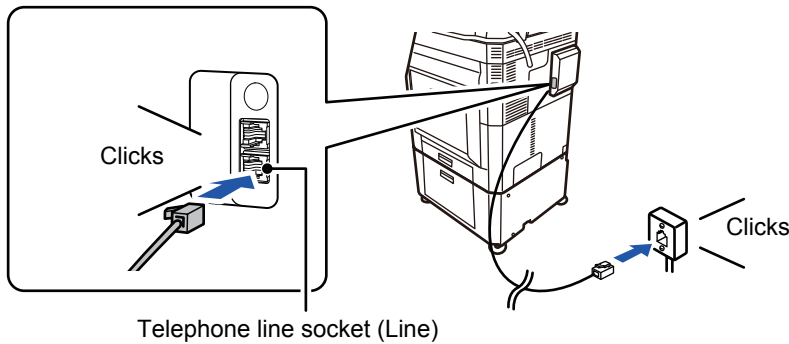

In some countries, an adapter is required to connect the telephone line cable to the wall telephone socket, as shown in the illustration.

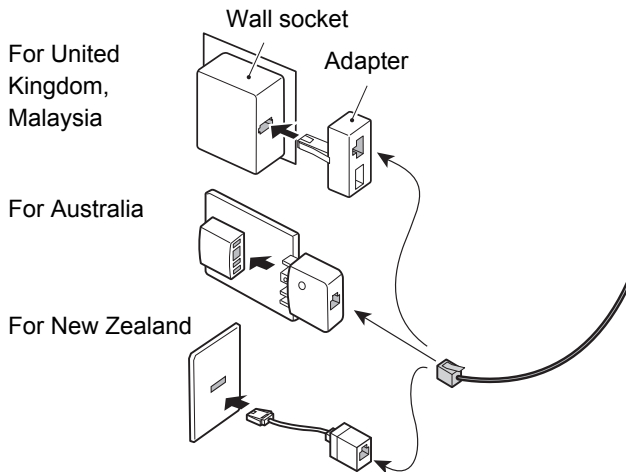

If the connection cable is not properly connected, "Sending has failed. Please check network connection." will appear when you attempt to send a fax. Properly connect the connection cable.



2

Make sure the main power switch is in the " I " position.

When the main power indicator is lit up, the main power is in the " I " position. If the main power indicator is not lit up, turn the main power switch to the " I " position and press the [POWER] button on the operation panel.

*If the fax function will be used, and in particular if reception or timer transmission will take place at night, always keep the main power switch in the " I " position.

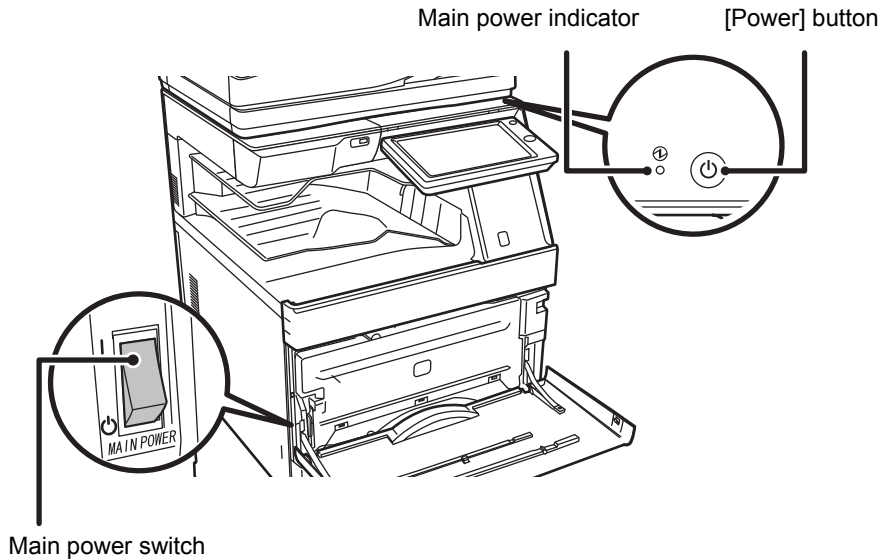

If the fax function will be used, and in particular if reception or timer transmission will take place at night, do not turn the main power off.

3

Setting the telephone line type.

The machine's dial mode setting must be set to match the type of telephone line you are using.

* If the setting is incorrect, it may result in dialling failures or cause calls to be made to the wrong destination.



- If you want to set the type of telephone line automatically
In "Settings (administrator)", select [System Settings] → [Image Send Settings] → [Fax Settings] → [Default Settings] → [Dial Mode Setting], and tap the [Auto Select] key.
- If necessary, you can set the type of telephone line manually.
- This setting can only be activated in Canada.

4

Checking the date and time.

Verify that the correct date and time are set in the machine.



To set the date and time of the machine:

In "Settings", select [System Settings] → [Common Settings] → [Clock Adjust].



If [Disabling of Clock Adjustment] has been enabled, the date and time cannot be modified.

In "Settings (administrator)", select [System Settings] → [Common Settings] → [Enable/Disable Settings] → [Operation Settings] → [Disabling of Clock Adjustment], and cancel the adjustment disabling setting.



5

Storing the sender fax number.

Store a sender name in [Sender Name] and a fax number in [Fax No.]. Be sure to configure this information, as it is required for communication.

**To store the sender's name and address:**

In "Settings (administrator)", select [System Settings] → [Image Send Settings] → [Common Settings] → [Own Number and Name Set] → [Sender Data Registration].

Storing destination addresses for each scan mode in the address book

When using fax, it is convenient to previously store addresses in the address book.

For how to use the address books and how to store addresses, see the following item.

- ▶ [ADDRESS BOOK \(page 1-98\)](#)
- ▶ [STORING ADDRESSES THROUGH DIRECT ENTRY \(page 1-102\)](#)
- ▶ [STORING ADDRESSES THROUGH GLOBAL ADDRESS SEARCH \(page 1-103\)](#)
- ▶ [STORING ADDRESSES FROM FAX OR IMAGE SEND LOGS \(page 1-105\)](#)
- ▶ [STORING GROUPS \(page 1-106\)](#)



FAX MODE

Fax mode has two modes: easy mode and normal mode.

Easy mode is limited to frequently used functions that allow you to smoothly perform most fax jobs.

If you need to select detailed settings or special functions, use normal mode. All functions can be used in normal mode.

EASY MODE

Easy mode makes it easy to select basic settings for fax.

1st screen

Show the size of the placed original.

Select an address.

Reset the address and settings.

Scans the original for preview.

► [PREVIEW SCREEN \(page 1-17\)](#)

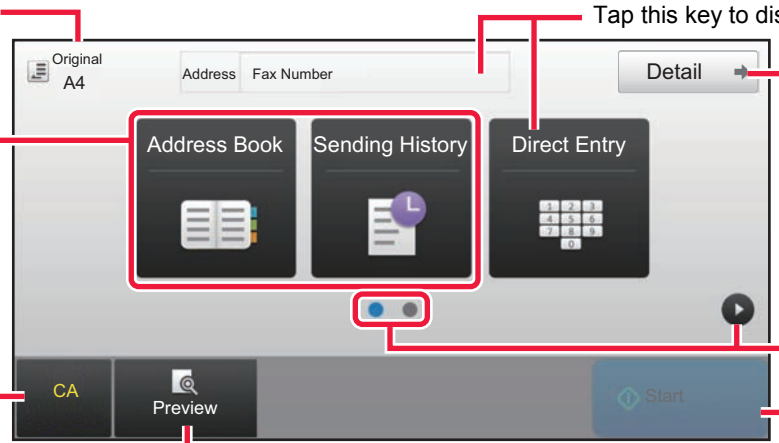

Tap this key to display the numeric keys.

Change to normal mode.
► [NORMAL MODE \(page 4-8\)](#)

Change the function display.

Immediately starts sending a fax.

2nd screen

Select function to be set up.

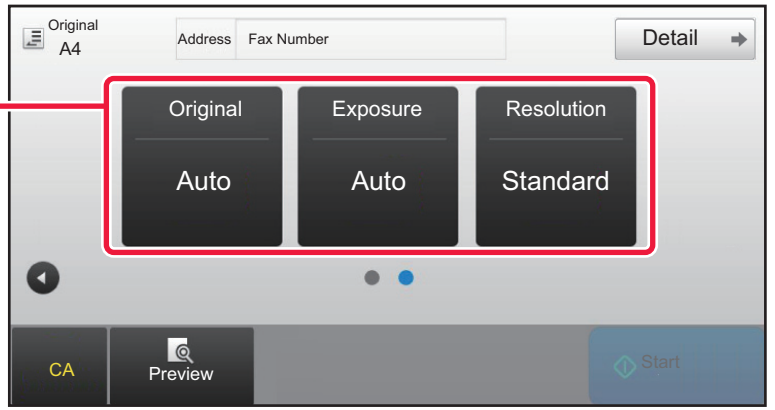

You can select these functions in easy mode.

•Original ► [page 4-45](#)

•Exposure ► [page 4-54](#)

•Resolution ► [page 4-55](#)



To select a function in easy mode

In "Settings", select [System Settings] → [Common Settings] → [Operation Settings] → [Easy Mode Settings] → [Easy Fax]



NORMAL MODE

Normal mode lets you select any function setting that can be used for fax.

Tap to display the numeric keys. Enter Fax No.

Used to display the address book and enter a destination.

Used to change fax settings.

Displays the list of setting keys. Frequently used [Others], programs, and other settings can be registered.

Check the current settings.

Displays the list of keys other than the function keys indicated above.

Displays the sizes of the original and the data to send.

Finds an address.

Displays functions available in fax mode.

Scans the original for preview. [► PREVIEW SCREEN \(page 1-17\)](#)

Reset the address and settings.

Immediately starts sending a fax.

Connects a line before starting sending a fax.

SELECTING FAX MODE

You can select the fax mode from the Home Screen or from each operation mode as follows:

Changing modes from the Home Screen

To select a mode, tap the icon for the mode in the home screen.

Shift to Easy Mode

Tap the [Easy Fax] mode icon

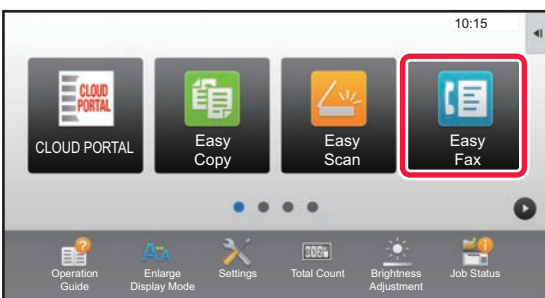

Shift to Normal Mode.

Tap the [Fax] mode icon

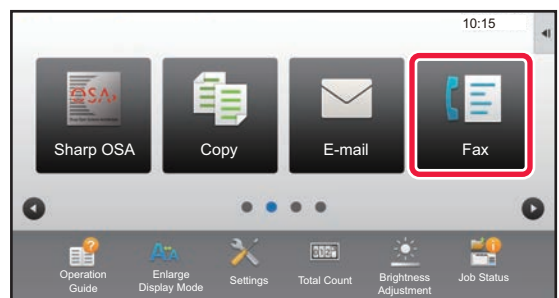



Changing mode from each mode

To change from one mode to another, tap the mode display.

1

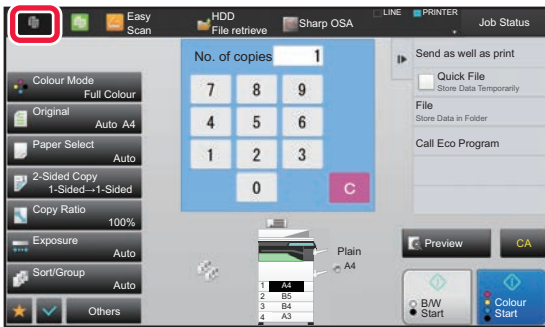

Tap on the mode display.

2

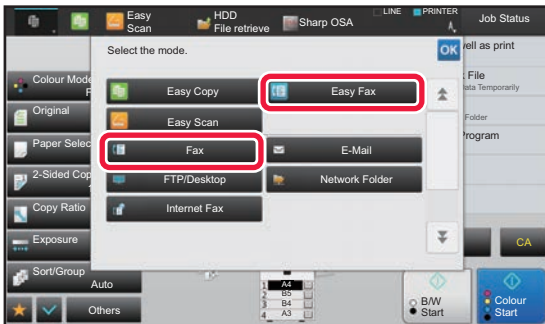

Tap the [Easy Fax] or [Fax] key.

The initial screen of the selected mode is displayed.



To change to normal mode from the initial screen of easy fax mode, tap the [Detail] key and tap the [Yes] key in the confirmation screen.

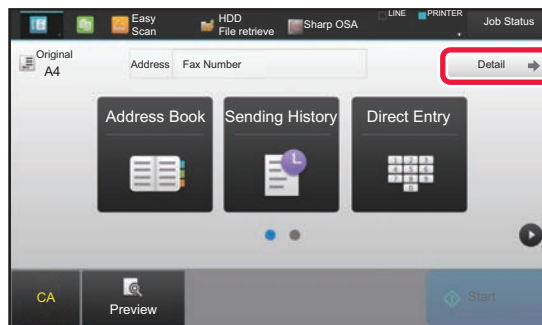



[R] KEY

When the machine is connected to a PBX, the "PBX Setting" can be enabled to automatically connect to the outside line each time you dial normally. When the PBX setting is enabled, the [R] key appears in the base screen. To dial a number inside your PBX, touch the [R] key before dialling to temporarily cancel the "PBX Setting".

In Easy mode

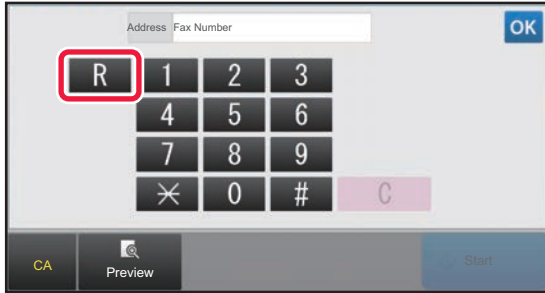

In Normal mode

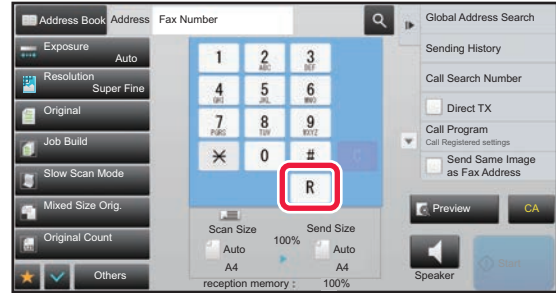

- This Setting can only be activated in Germany.
- The [R] key can be included in a fax number stored in an one-touch key.
- When the [Speaker] key is touched, the "PBX Setting" is temporarily cancelled and the [R] key does not appear.
- When the [R] key is touched before dialling, an F-code (sub-address and passcode) cannot be used. Likewise, an one-touch key in which an F-code (subaddress and passcode) is stored cannot be used.



System Settings (Administrator): PBX Setting

This is used to enable PBX Setting.



FAX TRANSMISSION SEQUENCE

This section explains the basic steps for sending a fax.

1

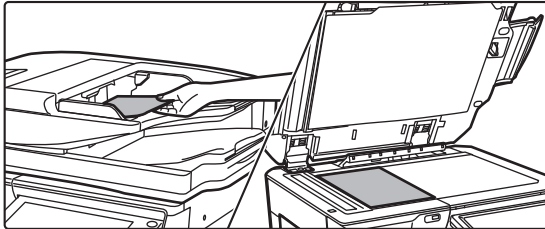

Place the original.

Place the original in the document feeder tray of the automatic document feeder, or on the document glass.

- [AUTOMATIC DOCUMENT FEEDER \(page 1-84\)](#)
- [DOCUMENT GLASS \(page 1-86\)](#)

2

Enter the destination fax number.

Tap the numeric keys to enter the destination number directly, or search and retrieve the address book or number.

In Easy mode

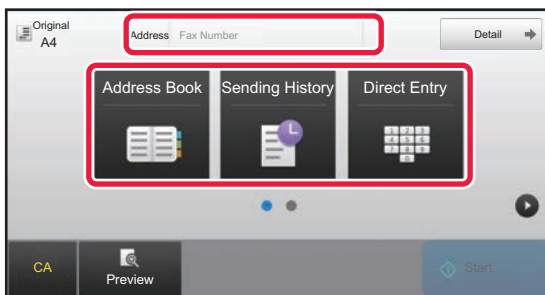

- ENTERING A DESTINATION NUMBER USING THE NUMERIC KEYS ► [page 4-13](#)
- RETRIEVING A DESTINATION FROM AN ADDRESS BOOK ► [page 4-14](#)
- USING A TRANSMISSION LOG TO RESEND ► [page 4-20](#)

In Normal mode

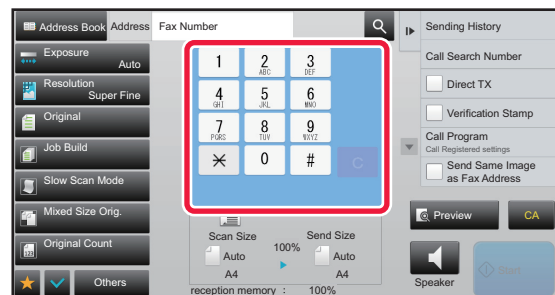

- ENTERING A DESTINATION NUMBER USING THE NUMERIC KEYS ► [page 4-13](#)
- RETRIEVING A DESTINATION FROM AN ADDRESS BOOK ► [page 4-14](#)
- USING A SEARCH NUMBER TO RETRIEVE A DESTINATION ► [page 4-17](#)
- RETRIEVING A DESTINATION FROM A GLOBAL ADDRESS BOOK ► [page 4-18](#)
- USING A TRANSMISSION LOG TO RESEND ► [page 4-20](#)



3

Configure the settings.

Specify the original scan size, exposure, resolution, etc.
If necessary, you can refer to the following functions for the setting.

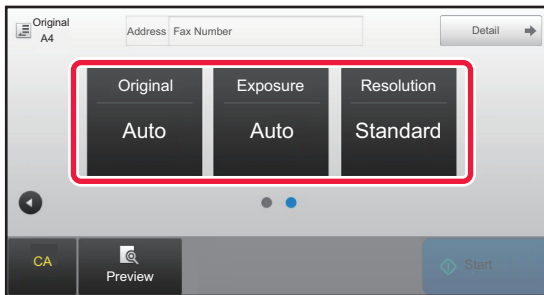
In Easy mode**In Normal mode**

- Scanning Originals [▶ page 4-86](#)
- Changing the Exposure [▶ page 4-54](#)
- Changing the Resolution [▶ page 4-55](#)

- Sending Originals Collectively [▶ page 4-74](#)
- Scanning Originals [▶ page 4-86](#)
- Automatically Scanning Both Sides Of an Original (2-sided Original) [▶ page 4-45](#)
- AUTO DETECTION [▶ page 4-46](#)
- Specifying the Original Scan Size Using Numeric Values [▶ page 4-48](#)
- Specifying the Send Size of the Image [▶ page 4-52](#)
- Changing the Exposure [▶ page 4-54](#)
- Changing the Resolution [▶ page 4-55](#)
- Sending a large Number of Pages (Job Build) [▶ page 4-78](#)
- Sending a Thin Original (Slow Scan Mode) [▶ page 4-89](#)
- Sending Originals of Different Sizes (Mixed Size Original) [▶ page 4-80](#)
- Checking the Number of Scanned Original Sheets Before Transmission (Original Count) [▶ page 4-91](#)
- Others [▶ page 4-72](#)

4

Send the original.

Tap the [Start] key.



- To check a preview of a scanned image, tap the [Preview] key before tapping the [Start] key.
- **When the original is placed on the document glass:**
 - When sending a fax normally (memory transmission)
Repeat the steps for placing and scanning the originals the same number of times as there are originals. After scanning all originals, tap the [Read-End] key.
 - When sending a fax in direct transmission mode
Multi-page originals cannot be scanned in direct transmission mode. Tap the [Start] key to start transmission.
- In normal mode, if you tap [File] or [Quick File] on the action panel before starting fax transmission, you can save the scanned original as data.
 - ▶ [QUICK FILE \(page 6-9\)](#)
 - ▶ [FILE \(page 6-10\)](#)



ENTERING DESTINATIONS

This section explains how to enter a destination from the initial screen of easy mode.

▶ [SELECTING FAX MODE \(page 4-8\)](#)

ENTERING DESTINATIONS

ENTERING A DESTINATION NUMBER USING THE NUMERIC KEYS

1

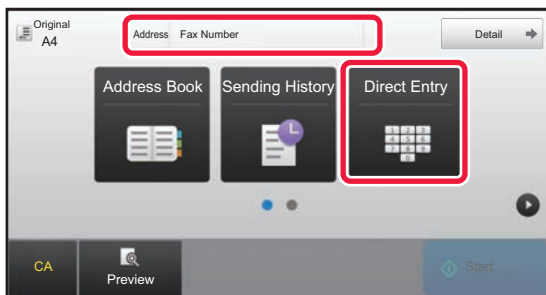

Tap the [Direct Entry] key or [Fax Number] to enter the destination fax number.

If you want to specify multiple destinations, tap **+** and enter the next fax number.

If you enter an incorrect number, tap the [C] key to delete the number and re-enter.

Entering a Pause Between Digits of the Number

Enter a pause after the number used to dial out from a PBX (for example, after "0"), or after the country code when dialling an international number.

1

Tap the [Pause] key.

A hyphen "-" is entered when the [Pause] key is tapped once.



If you want to enter a pause between digits of the number:

Enter a pause after the number used to dial out from a PBX (for example, after "0"), or after the country code when dialling an international number.

The [Pause] key appears on the numeric keys when the destination fax number is entered.

A hyphen "-" is entered when the [Pause] key is tapped once.



To set the length of pause:

In "Settings", select [System Settings] → [Image Send Settings] → [Fax Settings] → [Default Settings] → [Pause Time Setting].



RETRIEVING A DESTINATION FROM AN ADDRESS BOOK

A destination fax number is retrieved by simply tapping the one-touch key of that destination on the address book screen. (One-touch dialling)

It is also possible to store multiple fax numbers in a one-touch key, allowing you to retrieve all the numbers by simply tapping the key. This dialling method is convenient when you wish to send a fax to (or poll) multiple fax destinations. When destinations of other scan modes are stored in addition to fax destinations, an icon indicating the mode appears together with the name of the destination in each one-touch key.

	Fax
	Scan to E-mail
	Internet Fax (Direct SMTP)
	Scan to FTP
	Scan to Network Folder
	Scan to Desktop
	Group key with multiple destinations

- For information on the address book, see "[ADDRESS BOOK \(page 1-98\)](#)".
- For the procedure for storing an address in the address book, see "[STORING ADDRESSES THROUGH DIRECT ENTRY \(page 1-102\)](#)", "[STORING ADDRESSES THROUGH GLOBAL ADDRESS SEARCH \(page 1-103\)](#)", "[STORING ADDRESSES FROM FAX OR IMAGE SEND LOGS \(page 1-105\)](#)", "[STORING GROUPS \(page 1-106\)](#)".

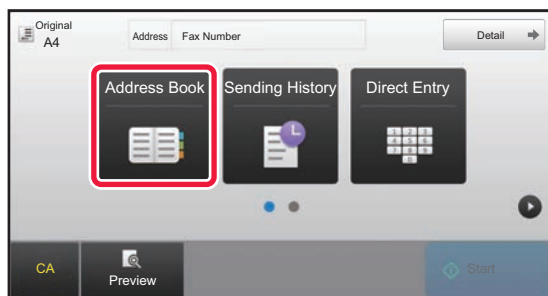
1

Tap the [Address Book] key.



2

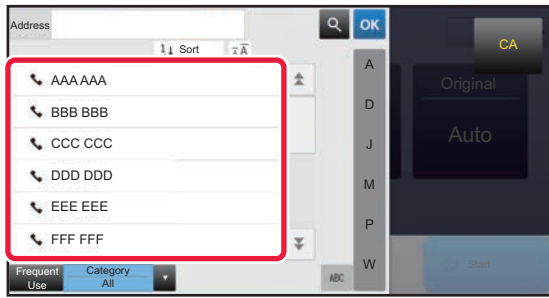

Tap a one-touch key of contact or group that includes the fax destination.

- The destinations displayed on the list can be narrowed with frequent use, categories, indexes, and keywords. (In normal mode, you can narrow down the destinations by job type.)
- Tapping [Sort] allows you to change the order of destinations displayed in the list.
- When adding a destination, tap another one-touch key.
- If two or more destinations are selected or specified, the total number of addresses appears next to address.
- Even if only a single destination is selected, the number of addresses appears when the destination is a contact or group in which multiple addresses are stored.

For more information, see "[ADDRESS BOOK SCREEN \(page 1-99\)](#)".



• If you select an incorrect destination:

Tap the key again to cancel the selection.

• To cancel a selected destination

Select the destination you want to cancel in the destination list screen, and tap the [Delete] key.



- To select a destination from the transmission log, tap the [Sending History] key.

▶ [USING A TRANSMISSION LOG TO RESEND \(page 4-20\)](#)

- To check the entered destinations, tap the [Address Review] key.

▶ [THE SELECTED DESTINATIONS \(page 4-16\)](#)

- The destination for transmission can be selected by tapping a stored destination.

- If an address that you do not have permission to use is included in the addresses, a message will appear when you press the [Start] key. To send only to the permitted addresses, press the [OK] key and then the [Enter for send] key.

In normal mode

- Tap the one-touch key, and then tap [Display Registered Information] on the action panel to display the detailed information.

- To retrieve a destination by using a search number, tap [Call Search Number] on the action panel.

▶ [USING A TRANSMISSION LOG TO RESEND \(page 4-20\)](#)

- To retrieve a destination from a global address book, tap [Global Address Search] on the action panel.

▶ [RETRIEVING A DESTINATION FROM A GLOBAL ADDRESS BOOK \(page 4-18\)](#)



To send to an address in other than the current mode

In "Settings (administrator)", remove the checkmark from [System Settings] → [Image Send Settings] → [Common Settings] → [Condition Settings] → [Address Book Default Selection] → [Apply Addresses of Sending Modes Only].



THE SELECTED DESTINATIONS

When multiple destinations have been selected, you can display and check the destinations. You can also delete a destination (cancel selection of the destination) if necessary.

1

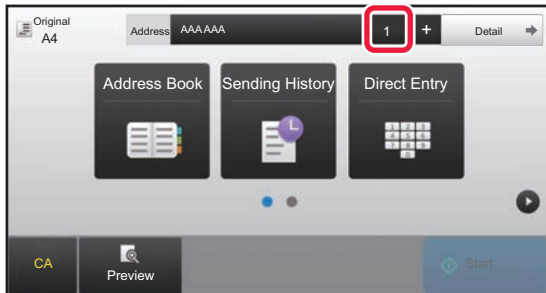

Tap the [All Destinations] key.

2

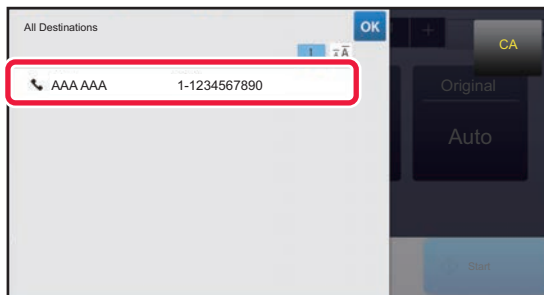

Confirm the destination.

After the confirmation is completed, tap **OK**.



- To confirm detailed information such as the type or name of the specified destination, tap the one-touch key of the target destination, and then tap the [Info.] key.
- If an address that you do not have permission to use is included, a prohibition mark will appear on the address.

DELETING SPECIFIED DESTINATIONS

Select the address and tap the [Delete] key.

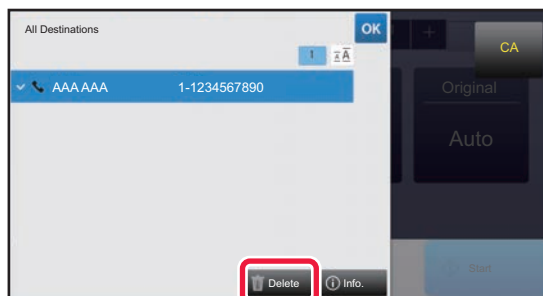

If you placed the original on the document glass and tapped the [Start] key, you cannot delete an address when changing settings.



USING A SEARCH NUMBER TO RETRIEVE A DESTINATION

The search number can be used to specify a destination stored in an address book.

1

Tap the [Detail] key to change to normal mode.

▶ [Changing mode from each mode \(page 4-9\)](#)

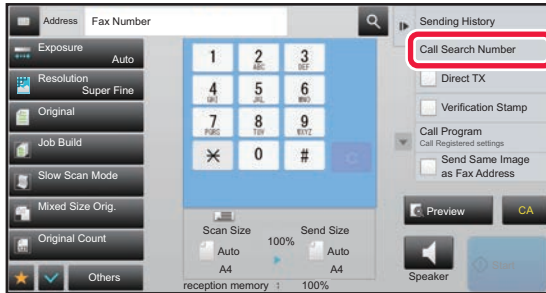
2

Tap [Call Search Number] on the action panel.

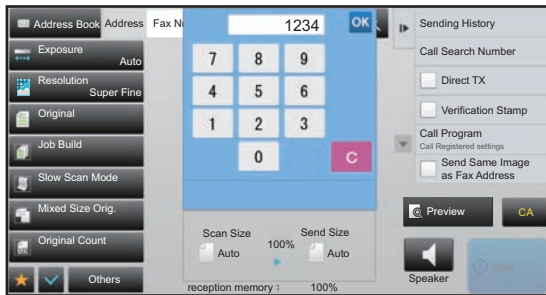
3

Enter a search number (4 digits) using the numeric keys and tap **OK**.

When the search number is entered, the stored address is retrieved and specified as a destination.



If an incorrect search number is entered:

Tap the [C] key to clear the number and enter the correct number.



- The search number is programmed when the destination is stored in the address book.
- If you do not know the search number, tap [Print Individual List] on the action panel to print and check the address list.
- When entering search numbers such as "0001" and "0011", "0" can be omitted. For example to enter "0001", enter "1" and tap **OK**.



RETRIEVING A DESTINATION FROM A GLOBAL ADDRESS BOOK

If an LDAP server is configured in the setting mode (Web version), you can search for the desired destination in the global address book and obtain the fax number when performing a fax transmission.

You can also add a retrieved address to the address book. However, addresses of the FTP/Desktop transmission cannot be stored from the machine.

1

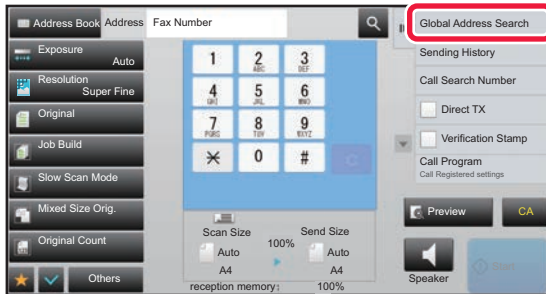

In the base screen or address book screen, tap [Global Address Search] on the action panel.

2

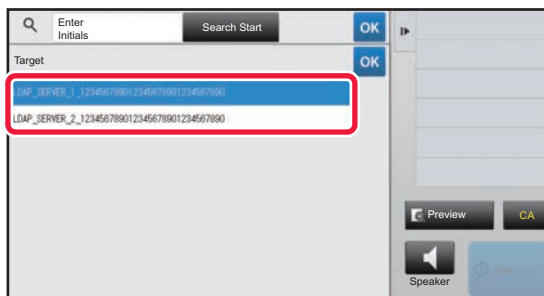

Tap [Target] and tap the LDAP server to be used.

- If an authentication screen for the LDAP server appears, enter your user name and password.
- If only one LDAP server has been stored, it is not necessary to take step 2. In this case, start from step 3.

After the settings are completed, tap **OK**.

3

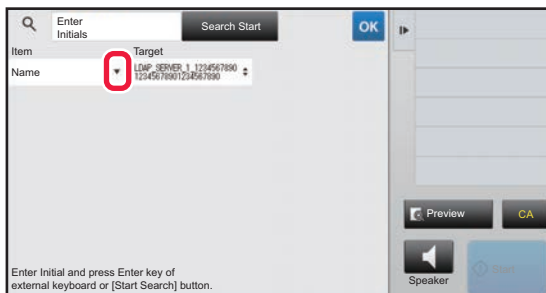

Tap **▼** of [Item], and select an item to be searched from [Name/Address].



How to search

Enter the search characters (maximum of 64 characters). The system will look for names starting with the entered letters.

An asterisk ***** can be used as follows:

- XXX* : Names beginning with "XXX"
- *XXX : Names that end with "XXX"
- *XXX* : Names containing "XXX"
- AA*XX : Names that start with "AA" and end with "XX".



4

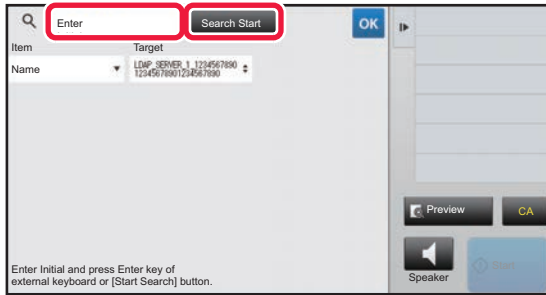

Enter a keyword and tap the [Search Start] key.

When you tap the keyword entry box, the soft keyboard appears.

The search results will appear after a brief interval.



- **If no destination is found:**

Tap the [Search Again] key.

- **To continuously add other destination.**

Tap the destination.



- **To check the destination information:**

Tap the one-touch key of the target destination, and then tap the [Info.] key. Tap **OK** to close the address information screen.

When you select the destination and tap the [New Registration with Address Book] on the action panel, the destination can be stored in the address book. This is convenient if you have entered a destination directly.



USING A TRANSMISSION LOG TO RESEND

Select a destination from a transmission log and resend the data.

The destinations of the most recent 50 transmissions by fax, Scan to E-mail, and/or Internet fax are stored. One of these can be selected to resend to that destination. The destinations of the FTP/Desktop transmission and Scan to Network Folder are also shown in the transmission log.

In normal mode, you can also add an address in a transmission history to the address book. This is a convenient way to store the fax numbers and addresses of destinations that were manually entered. However, addresses of the Network Folder transmission cannot be stored from the machine.



- If numeric keys were tapped during the previous transmission, the number may not be redialled correctly.
- The fax addresses below are not stored as addresses for which resend is possible.
 - One-touch key for a contact in which multiple destinations are stored.
 - Group destinations
 - Broadcasting destinations

1

In Easy mode

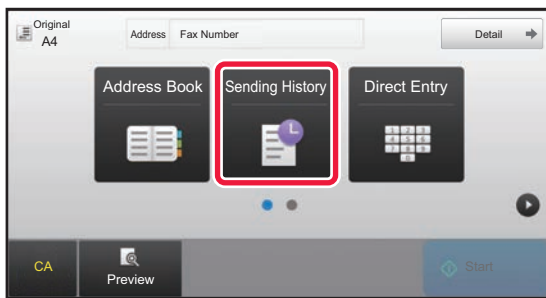

Tap the [Sending History] key.

In Normal mode

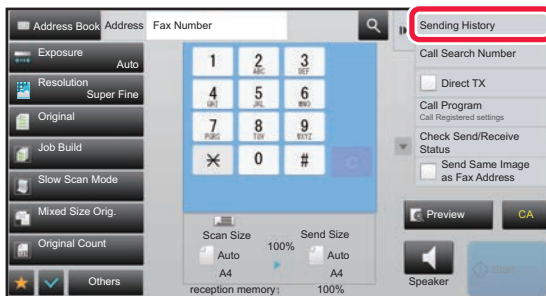

In the base screen or address book screen, tap [Sending History] on the action panel.



2

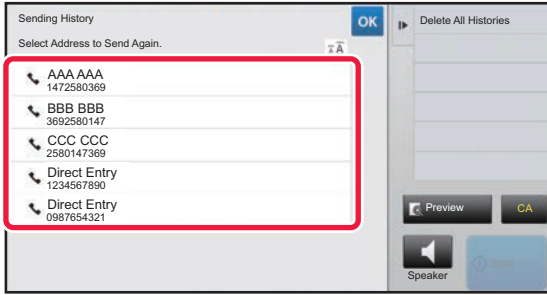

Tap the key of the fax destination that you wish to redial.

The last 50 addresses used for transmission are displayed.



To cancel the resend setting:

Tap the highlighted key.



In normal mode

- To add an address to the address book, select the address and tap [New Registration with Address Book] or [Additional Registration with Address Book] on the action panel.
- You can select an address and tap [Delete the Selected History] or [Delete All Histories] on the action panel to delete one or all histories.



SENDING BY CHAIN DIALLING

Number sequences entered using the numeric keys and/or one-touch keys can be linked together with pauses and dialled as a single number.

For example when dialling an international number, tap the [Pause] key between the identification number of an international telephone service company (e.g., "001") and the country code (e.g., "81" for Japan) to insert a pause for smoother line connection.

The time (in seconds) set in [Pause Time Setting] of "Settings (administrator)" defines the length of pause.

On the screen, a hyphen "-" indicates a pause.

If two seconds are set in [Pause Time Setting], tapping the [Pause] key three times enters pauses for 6 seconds.

Example: Using chain dialling to dial an international number

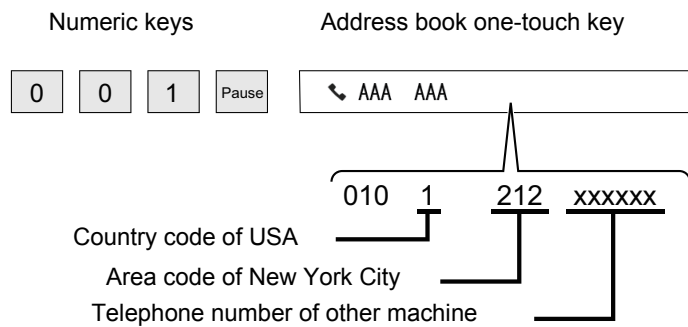

- Addresses that can be selected are addresses that only have one fax address saved.
- After entering the number with the numeric keys, tap the [Pause] key to enter the next number with the numeric keys, or tap the [Chain Dial] key on the action panel to select an address from the address book.
- After selecting the address from the address book, select [Chain Dial Combine with Direct Input] on the action panel to enter the next number with the numeric keys, or [Chain Dial Combine with Address Book] to select an address from the address book.



To set the length of pause:

In "Settings", select [System Settings] → [Image Send Settings] → [Fax Settings] → [Default Settings] → [Pause Time Setting].



BASIC TRANSMISSION METHODS

This section explains how to enter a destination from the initial screen of easy mode.

► [SELECTING FAX MODE \(page 4-8\)](#)

BASIC TRANSMISSION METHODS

FAX TRANSMISSION METHODS

The methods that can be used to send a fax from the machine are described below. Select the method that best suits your needs.

To fax a large number of sheet originals:

Use the automatic document feeder.

The originals will be scanned into memory and then transmitted (memory transmission).

When multiple original sheets are placed in line idle state, they will be sent in sequence from the scanned page in parallel with the scanning process (Quick On Line Sending).

If transmission cannot begin immediately because the line is in use, all pages will be scanned and stored in memory.

► [USING THE AUTOMATIC DOCUMENT FEEDER FOR TRANSMISSION \(page 4-30\)](#)

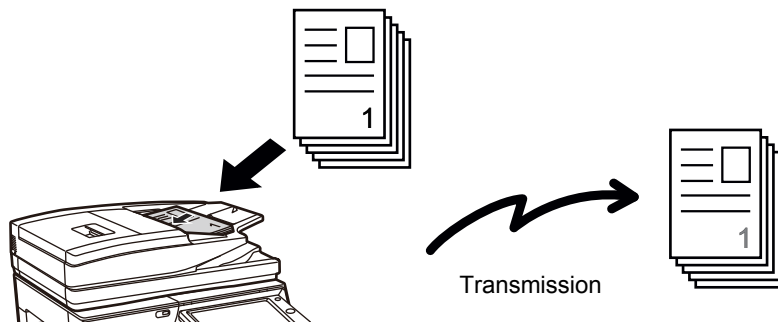

Storing a fax job

If transmission cannot begin immediately because the line is in use, all pages will be scanned and stored in memory. If you want to attempt to send a fax while another job is in progress, you can store the fax job. To check the stored fax job, display the job status screen.

► [FAX JOBS \(page 4-124\)](#)



- If memory becomes full while the first original page is being scanned, transmission will stop.
- When the transmission is finished, the scanned original pages are cleared from memory. However, when the document filing function is used, the transmitted fax is stored.
 - [QUICK FILE \(page 6-9\)](#)
 - [FILE \(page 6-10\)](#)
- If Job Build is enabled, you can select the automatic document feeder or the document glass to scan the original. This sending method may not be available depending on the function.
 - [SENDING A LARGE NUMBER OF PAGES \(JOB BUILD\) \(page 4-78\)](#)



In the following situations, the transmission will be automatically reserved (memory transmission)

- When the line is busy or a communication error occurs and automatic resending is enabled.
 - ▶ [WHEN A COMMUNICATION ERROR OCCURS \(page 4-28\)](#)
- The line of the machine will be busy if another fax is being sent, received, or if the machine is in the busy state.
- Another fax transmission was reserved ahead of your fax.
- One of the following functions is being used for transmission.
 - Broadcast transmission, F-code transmission, Timer transmission, Dual Page Scan, Book Divide, N-Up, Card Shot, Job Build, Original Count
- The document glass is being used (except when the speaker is being used to dial).



To disable the Quick On Line Sending setting:

In "Settings", select [System Settings] → [Image Send Settings] → [Fax Settings] → [Send Settings] → [Quick On Line Sending].

If you disable this setting, transmission will not begin until all pages have been scanned. Note that this setting does not apply to manual transmission.

To fax thick originals or pages of a book:

Place the original on the document glass.

- ▶ [USING THE DOCUMENT GLASS FOR TRANSMISSION \(page 4-33\)](#)

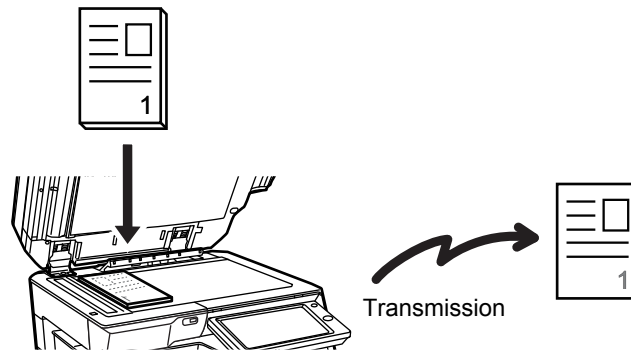

- Quick On Line Sending is not available when a fax is being sent from the document glass.
- When the document glass is used, multiple original pages cannot be scanned at a time. In this case, the original pages can be separated into multiple times of scanning.

If you wish to send a fax ahead of other previously reserved fax transmissions:

Send the fax in direct transmission mode. The original is transmitted directly to the receiving fax machine without being scanned into memory.

When direct transmission mode is used, transmission will begin as soon as the transmission in progress is completed (ahead of any previously reserved transmissions).

Tap [Direct TX] on the action panel to send a fax.

- ▶ [USING THE AUTOMATIC DOCUMENT FEEDER FOR FAXING IN DIRECT TX MODE \(page 4-31\)](#)
- ▶ [USING THE DOCUMENT GLASS TO SEND A FAX IN DIRECT TX MODE \(page 4-35\)](#)





When transmission in direct transmission mode ends, the mode automatically changes back to memory transmission mode.





In direct transmission mode, the [Preview] key cannot be used for transmission.



ORIGINAL ORIENTATION

When an A4 (8-1/2" x 11") original is placed in vertical orientation (), the image is automatically rotated 90 degrees and transmitted in horizontal orientation () (Rotation Sending).

If the original is placed in horizontal orientation (), it is transmitted in that orientation () without being rotated.

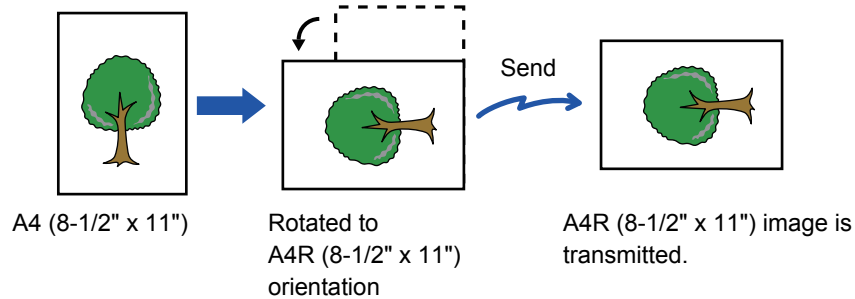

Rotation sending is not available for originals with A4R, B5, or A5 (8-1/2" x 11" or 5-1/2" x 8-1/2") size.



To cancel the rotation sending setting:

In "Settings (administrator)", select [System Settings] → [Image Send Settings] → [Fax Settings] → [Send Settings] → [Rotation Sending Setting].

If this setting is disabled, the original will be transmitted in the orientation in which it is placed.

Because of this, some receiving machines may reduce the received data.



AUTOMATIC REDUCTION OF THE TRANSMITTED IMAGE

If the width of the transmitted image is larger than the width of the paper in the receiving machine, the image will be automatically reduced to fit the receiving machine's paper width.

Example: Reduced sizes and reduction ratios

Transmitted image width	Receiving machine's paper width	Reduced size	Scaling
A3 (11" x 17")	B4	B4	1:0.8
A3 (11" x 17")	A4 (8-1/2" x 11")	A4R	1:0.7
B4	A4 (8-1/2" x 11")	A4R	1:0.8



To cancel the Auto Reduction Sending setting:

In "Settings", select [System Settings] → [Image Send Settings] → [Fax Settings] → [Send Settings] → [Auto Reduction Sending Setting].

If this setting is disabled, the image will be sent at full size and part of the image may be cut off.

TRANSMITTABLE ORIGINAL SIZES

The following original sizes can be transmitted.

	Minimum original size	Maximum original size
Using the automatic document feeder	131 mm (height) x 140 mm (width) (5-1/8" (height) x 5-1/2" (width))	297 mm (height) x 1000mm (width) (11-5/8" (height) x 39-3/8" (width))
Using the document glass	-	297 mm (height) x 432 mm (width) (11-5/8" (height) x 17" (width))

A long original can be transmitted.



THE SIZE OF THE PLACED ORIGINAL

When a standard size original is placed, the original size is automatically detected and displayed in "Scan Size" on the base screen.

► [AUTO DETECTION \(page 4-46\)](#)

Standard sizes are sizes that the machine can automatically detect. The standard sizes are set in "Original Size Detector Setting" in setting mode.



When the automatic original detection function is operating and the original (of inch or non-standard size) is placed, the closest size may be displayed or the original size may not appear. In this event, manually set the correct original size.

► [SPECIFYING THE ORIGINAL SCAN SIZE IN PAPER SIZE \(page 4-47\)](#)

► [SPECIFYING THE ORIGINAL SCAN SIZE USING NUMERIC VALUES \(page 4-48\)](#)



To specify the size that the machine can automatically detect:

In "Settings (administrator)", select the group of detected original sizes in [System Settings]→ [Common Settings] → [Device Control] → [Original Size Detector Setting].

List of original size detector settings

Selections	Sizes (detected original sizes)	
	DOCUMENT GLASS	Document feeder tray (automatic document feeder)
AB-1	A3, A4, A4R, A5, B4, B5, B5R	11" x 17", 8-1/2" x 14", 8-1/2" x 11", A3, A4, A4R, A5, B4, B5, B5R
AB-2	A3, A4, A4R, A5, B5, B5R, 216 mm x 330 mm (8-1/2" x 13")	A3, A4, A4R, A5, B4, B5, B5R, 11" x 17", 8-1/2" x 11", 216 mm x 330 mm (8-1/2" x 13")
AB-3	A4, A4R, A5, B4, 8K, 16K, 16KR	A3, A4, A4R, A5, B4, 11" x 17", 8-1/2" x 11", 216 mm x 330 mm (8-1/2" x 13"), 8K, 16K, 16KR
AB-4	A3, A4, A4R, A5, B5, B5R, 216 mm x 340 mm (8-1/2" x 13-2/5")	A3, A4, A4R, A5, B4, B5, B5R, 11" x 17", 8-1/2" x 11", 216 mm x 340 mm (8-1/2" x 13-2/5")
AB-5	A3, A4, A4R, A5, B5, B5R, 216 mm x 343 mm (8-1/2" x 13-1/2")	A3, A4, A4R, A5, B4, B5, B5R, 11" x 17", 8-1/2" x 11", 216 mm x 343 mm (8-1/2" x 13-1/2")
Inch-1	11" x 17", 8-1/2" x 14", 8-1/2" x 11", 8-1/2" x 11"R, 5-1/2" x 8-1/2"	11" x 17", 8-1/2" x 14", 8-1/2" x 11", 8-1/2" x 11"R, 5-1/2" x 8-1/2", A3, A4
Inch-2	11" x 17", 8-1/2" x 13" (216 mm x 330 mm), 8-1/2" x 11", 8-1/2" x 11"R, 5-1/2" x 8-1/2"	11" x 17", 8-1/2" x 13-2/5 (216 mm x 340 mm), 8-1/2" x 11", 8-1/2" x 11"R, 5-1/2" x 8-1/2", A3, A4
Inch-3	11" x 17", 8-1/2" x 13-2/5" (216 mm x 340 mm), 8-1/2" x 11", 8-1/2" x 11"R, 5-1/2" x 8-1/2"	11" x 17", 8-1/2" x 13-2/5 (216 mm x 340 mm), 8-1/2" x 11", 8-1/2" x 11"R, 5-1/2" x 8-1/2", A3, A4



WHEN THE LINE IS BUSY

If the line is busy when you send a fax, transmission will be attempted again automatically after a preset interval. This function only operates in memory transmission mode. In direct transmission mode or manual transmission mode, the transmission will be cancelled. Wait for a brief period and then try sending the fax again.

**To cancel transmission:**

Do so from the job status screen.

► [STOPPING/DELETING A JOB IN PROGRESS OR RESERVED \(page 1-90\)](#)



To set the number of recall attempts and the interval between attempts when the connection cannot be established because the line is busy, or for other reasons:

In "Settings (administrator)", select [System Settings] → [Image Send Settings] → [Fax Settings] → [Send Settings] → [Recall in Case of Line Busy].

WHEN A COMMUNICATION ERROR OCCURS

If a communication error occurs or the other fax machine does not answer the call within a preset period of time, transmission will automatically be attempted again after a preset interval. This function only operates in memory transmission mode.



In direct transmission mode, transmission will not automatically be attempted again

**To cancel transmission:**

Do so from the job status screen.

► [STOPPING/DELETING A JOB IN PROGRESS OR RESERVED \(page 1-90\)](#)

**To set the number of recall attempts and the interval between attempts when a transmission fails due to an error:**

In "Settings (administrator)", select [System Settings] → [Image Send Settings] → [Fax Settings] → [Send Settings] → [Recall in Case of Communication Error].



FAX DEST. CONFIRMATION MODE

This mode displays a destination confirmation message when a fax is sent to prevent accidental transmission to the wrong destination. Set it in setting mode. If a fax is sent while this function is enabled, an address confirmation message will appear when the [Start] key is tapped.

The message that appears will vary depending on the method used to specify the destination.



After tapping the [Speaker] key while "Fax Dest. Confirmation Mode" is enabled, the destination cannot be specified using the numeric keys, one-touch key, [Call Search Number] key, or [Sending History] key. However, it is possible to send through a telephone.



- To display the destination confirmation message prior to fax transmission:
In "Settings", select [System Settings] → [Image Send Settings] → [Fax Settings] → [Default Settings] → [Fax Dest. Confirmation Mode].
- To disable fax broadcast when Fax Dest. Confirmation Mode is enabled:
In "Settings", select [System Settings] → [Image Send Settings] → [Fax Settings] → [Send Settings] → [Disable Fax Broadcasting].

Destination specified by one-touch key/search number/global address search

Tap the [Start] key to display all destinations in the destination confirmation screen. Check that the destinations are correct, and tap the [Enter for send] key to start scanning of the original.

If the destination is not correct, tap the [OK] key and select the destination again.



- You can select multiple one-touch keys for contacts or groups including fax destinations.
- Before tapping the [Enter for send] key, you can change scan or other settings.

Destination specified using the numeric keys

Tap the [Start] key to display the confirmation message.

Tap the [OK] key, re-enter the destination using the numeric keys, and tap the [Enter Address] key.

If the re-entered destination is correct, scanning will begin.

If the re-entered destination is not correct, a message will appear. Tap the [OK] key and re-enter the destination. If an incorrect address is entered three times for confirmation, all the previous settings are cancelled, and you will return to the base screen.



- You can use the numeric keys to enter fax numbers serially. In that case, tap **+** to enter the destination fax number to be added.
- If the [Sub Address] key was tapped to enter a sub-address and passcode, the fax number must be re-entered during confirmation. After re-entering the fax number, tap the [Sub Address] key and enter the sub-address and passcode.
- If chain dialling was used, tap the [Pause] key to enter "-" during confirmation.
- Before tapping the [Enter for send] key, you can change scan or other settings.

When a fax that was selected from the Sending History has been resent

A confirmation screen is displayed based on the method used to specify the destination during the previous transmission.



CHECKING THE IMAGE TO BE TRANSMITTED

Check the image that will be sent in the touch panel before transmission.

You can tap the [Preview] key and then scan the original to check a preview of the scanned image. As you can adjust the exposure and resolution to scan the original while checking it in the preview screen, you can send a better quality original to the destination.

► [PREVIEW SCREEN \(page 1-17\)](#)

The settings and functions that can be changed while and after an image is scanned for preview are as follows: Exposure, Send Size, 2-Sided Booklet/Tablet, Resolution, Erase, N-Up, File, Quick File, Timer, Own Name Select, and Transaction Report.



- Depending on the size of the transmission data, part of the preview image may not appear in the preview screen in the touch panel.
- The preview function is not available when the original size is set to Long Size.

FAX TRANSMISSION METHODS

USING THE AUTOMATIC DOCUMENT FEEDER FOR TRANSMISSION

Storing scanned originals in machine's memory before transmitting them is called "Memory TX".

This section explains how to scan the original through the automatic document feeder and send the data by the memory transmission function.



- To fax a thick original or other original that cannot be placed in the automatic document feeder, open the automatic document feeder and place the original on the document glass.
- If there is a fax job in progress when the transmission operation is performed, the fax is transmitted when the job in progress is finished.
- If the memory becomes full while the originals are being scanned, a message will appear and scanning will stop. When Quick On Line Sending is enabled for transmission, the scanned originals are sent.



- To disable the Quick On Line Sending setting:
In "Settings (administrator)", select [System Settings] → [Image Send Settings] → [Fax Settings] → [Send Settings] → [Quick On Line Sending].
If you disable this setting, memory transmission will not begin until all pages have been scanned.
- To set the scan complete sound:
In "Settings (administrator)", select [System Settings] → [Image Send Settings] → [Common Settings] → [Condition Settings] → [Scan Complete Sound Setting].

1

Place the original in the document feeder tray of the automatic document feeder.

► [AUTOMATIC DOCUMENT FEEDER \(page 1-84\)](#)

2

Specify the destination fax number.

- Entering a destination number using the numeric keys ► [page 4-13](#)
- Retrieving a destination from an address book ► [page 4-14](#)
- Using a search number to retrieve a destination ► [page 4-17](#)
- Retrieving a destination from a global address book ► [page 4-18](#)
- Using a transmission log to resend ► [page 4-20](#)



3

Tap the [Start] key to begin transmission.

When scanning is completed, the machine beeps.



- Tap the [Preview] key to check the preview of an image before sending a fax. For more information, see "[CHECKING THE IMAGE TO BE TRANSMITTED \(page 4-30\)](#)".
- When all originals have been scanned, "Job stored." will be displayed together with a job control number. This number is recorded in the transaction report and image sending activity report and can be used to check fax jobs.
 - ▶ [PRINTING IMAGE SENDING ACTIVITY REPORTS \(page 4-125\)](#)

**To cancel scanning the original:**

Tap the [Cancel Scan] key.

USING THE AUTOMATIC DOCUMENT FEEDER FOR FAXING IN DIRECT TX MODE

Sending a scanned original without saving it in the machine's memory is called "Direct TX".

This section explains how to scan the original through the automatic document feeder and directly send it.



To fax a thick original or other original that cannot be placed in the automatic document feeder, open the automatic document feeder and place the original on the document glass.



- The following functions cannot be used with direct transmission:
Timer Transmission, N-Up, Card Shot, Job Build, Polling Memory, Original Count, File, Quick File, Memory Box, Book Divide, Poling, 2-Sided Scan, Search Global Address Book
- Resending will not take place when a direct transmission is not successful due to a communication error or other reason.
- If a fax transmission is already in progress when the direct transmission operation is performed, the direct transmission will wait until the previous transmission is finished. When the previous transmission is completed, the direct transmission will begin.
- While the direct transmission is waiting, the job status display can be tapped to display the job status screen. No other operations are possible.
 - ▶ [FAX JOBS \(page 4-124\)](#)
- The [Preview] key cannot be used for transmission.

1

Tap the [Detail] key to change to normal mode.

- ▶ [Changing mode from each mode \(page 4-9\)](#)

2

Place the original in the document feeder tray of the automatic document feeder.

- ▶ [AUTOMATIC DOCUMENT FEEDER \(page 1-84\)](#)



3



Specify the destination fax number, and tap [Direct TX] on the action panel.

4

Specify the destination fax number.

- Entering a destination number using the numeric keys ► [page 4-13](#)
- Retrieving a destination from an address book ► [page 4-14](#)
- Using a search number to retrieve a destination ► [page 4-17](#)
- Using a transmission log to resend ► [page 4-20](#)



- Only one destination can be specified. A one-touch key in which multiple destinations are stored cannot be used.
- The destination cannot be retrieved from a global address book.

5

Tap the [Start] key to begin transmission.



If a fax transmission is already in progress when the direct transmission operation is performed, the direct transmission will wait until the previous transmission is finished. When the previous transmission is completed, the direct transmission will begin.

While the direct transmission is waiting, you can only check the job status.

- [TYPES OF JOB STATUS SCREENS \(page 1-88\)](#)



To cancel scanning the original:

Tap the [Cancel Scan] key.



USING THE DOCUMENT GLASS FOR TRANSMISSION

Storing scanned originals in machine's memory before transmitting them is called "Memory TX".

This section explains how to scan the original placed on the document glass and send the data by the memory transmission function.



- If a fax is being received when the transmission operation is performed, the transmission will be reserved and transmission will take place after fax reception is completed.
- If the memory becomes full while the originals are being scanned, a message will appear and transmission will be cancelled.



Do not place any objects under the original size detector. Closing the automatic document feeder with an object underneath may damage the original size detector plate and prevent correct detection of the document size.

1

Place the original on the document glass.

► [DOCUMENT GLASS \(page 1-86\)](#)



When faxing a multi-page original, scan each page in order starting from the first page.

2

Specify the destination fax number.

- Entering a destination number using the numeric keys ► [page 4-13](#)
- Retrieving a destination from an address book ► [page 4-14](#)
- Using a search number to retrieve a destination ► [page 4-17](#)
- Retrieving a destination from a global address book ► [page 4-18](#)
- Using a transmission log to resend ► [page 4-20](#)

3

Tap the [Start] key to begin transmission.

When scanning is completed, the machine beeps.

4

If you have another page to scan, change pages and then tap the [Start] key.

Repeat until all originals have been scanned.



If no action is taken for one minute, scanning automatically ends and the transmission is reserved.

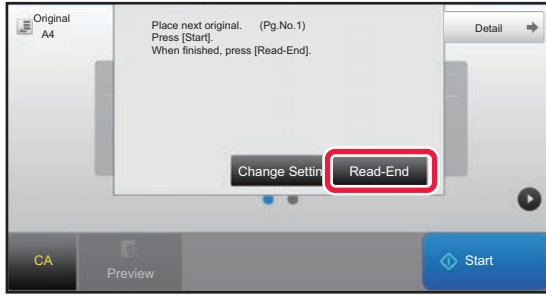

5

**Tap the [Read-End] key.**

A beep sounds.

Open the automatic document feeder and remove the original.

**To cancel scanning:**

Tap the [CA] key before the [Read-End] key is tapped.



- When all originals have been scanned, "Job stored." will be displayed together with a job control number. This number can be used to locate the job in the Transaction Report or in the Image Sending Activity Report.
 - [PRINTING IMAGE SENDING ACTIVITY REPORTS \(page 4-125\)](#)
- If no action is taken for one minute after the confirmation screen is displayed, scanning automatically ends and the transmission is reserved.
- The [Change Setting] key can be tapped, if necessary, to change the exposure, resolution, scan size, and send size for each original page scanned. However, when "N-Up" or "Card Shot" is selected in Others, only the exposure can be changed when scanning an even-numbered original page.

**To cancel transmission:**

Tap the [CA] key before the [Read-End] key is tapped.



USING THE DOCUMENT GLASS TO SEND A FAX IN DIRECT TX MODE

Sending a scanned original without saving it in the machine's memory is called "Direct TX".

This section explains how to scan the original placed on the document glass and directly send data.

When sending a fax from the document glass in direct transmission mode, only one page can be transmitted.



- The following functions cannot be used with direct transmission:
Timer Transmission, N-Up, Card Shot, Job Build, Polling Memory, Original Count, File, Quick File, Memory Box, Book Divide, Poling, 2-Sided Scan, Search Global Address Book
- Resending will not take place when a direct transmission is not successful due to a communication error or other reason.
- If a fax transmission is already in progress when the direct transmission operation is performed, the direct transmission will wait until the previous transmission is finished. When the previous transmission is completed, the direct transmission will begin.
- While the direct transmission is waiting, the job status display can be tapped to display the job status screen. No other operations are possible.
 - ▶ [FAX JOBS \(page 4-124\)](#)
- The [Preview] key cannot be used for transmission.



Do not place any objects under the original size detector. Closing the automatic document feeder with an object underneath may damage the original size detector plate and prevent correct detection of the document size.

1

Tap the [Detail] key to change to normal mode.

▶ [Changing mode from each mode \(page 4-9\)](#)

2

Place the original on the document glass.

▶ [DOCUMENT GLASS \(page 1-86\)](#)



When faxing a multi-page original, scan each page in order starting from the first page.

3

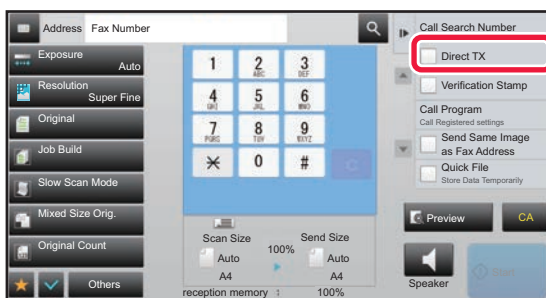

Specify the destination fax number, and tap [Direct TX] on the action panel.



4

Specify the destination fax number.

- Entering a destination number using the numeric keys ► [page 4-13](#)
- Retrieving a destination from an address book ► [page 4-14](#)
- Using a search number to retrieve a destination ► [page 4-17](#)
- Using a transmission log to resend ► [page 4-20](#)



- Only one destination can be specified. A one-touch key in which multiple destinations are stored cannot be used.
- The destination cannot be retrieved from a global address book.

5

Tap the [Start] key to begin transmission.

When the line has been connected to the destination, scanning of the original starts.



If a fax transmission is already in progress when the direct transmission operation is performed, the direct transmission will wait until the previous transmission is finished. When the previous transmission is completed, the direct transmission will begin.

While the direct transmission is waiting, you can only check the job status.

- [TYPES OF JOB STATUS SCREENS \(page 1-88\)](#)

**To cancel scanning the original:**

Tap the [Cancel Scan] key.



TRANSMISSION USING THE SPEAKER

When the speaker is used to dial, the fax is sent after the number is dialled and the connection is established.



- If a person answers, you will be able to hear his or her voice, but you will not be able to speak.
- When the speaker is used, transmission takes place without scanning the original into memory.
- A destination that includes an F-code (sub-address and passcode) cannot be used.
- A one-touch key that has multiple destinations or has a non-fax destination cannot be used.
- In speaker mode, the [Preview] key cannot be used for transmission.

1

Tap the [Detail] key to change to normal mode.

- ▶ [Changing mode from each mode \(page 4-9\)](#)

2

Place the original.

Place the original in the document feeder tray of the automatic document feeder, or on the document glass.

- ▶ [AUTOMATIC DOCUMENT FEEDER \(page 1-84\)](#)
- ▶ [DOCUMENT GLASS \(page 1-86\)](#)

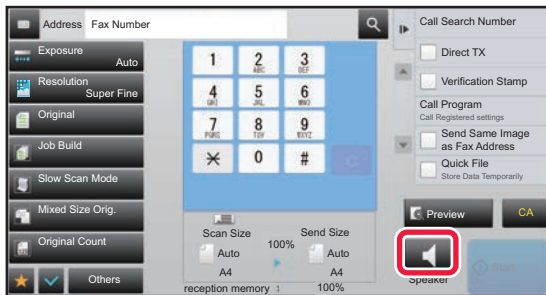
3

Tap the [Speaker] key.

When the connection is established, you will hear the dial tone through the machine's speaker.



Tapping allows you to use the slider or keys to adjust the volume of the speaker.

4

Specify the destination fax number.

- Entering a destination number using the numeric keys ▶ [page 4-13](#)
- Retrieving a destination from an address book ▶ [page 4-14](#)
- Using a search number to retrieve a destination ▶ [page 4-17](#)
- Using a transmission log to resend ▶ [page 4-20](#)



A one-touch key in which multiple destinations are stored cannot be used.

5

When the connection is made, tap the [Start] key to begin transmission.



To cancel transmission:

To stop transmission, tap the [Sending Cancelled] key. To stop communication, tap the [Speaker] key.



SENDING THE SAME FAX TO MULTIPLE DESTINATIONS (BROADCAST TRANSMISSION)

You can send a fax to multiple destinations in a single operation when, for example, sending a report to branch offices in different regions. This function is called "Broadcasting".

One operation allows you to send data to up to 500 destinations, including the reserved send jobs. (For example, if broadcast transmission jobs with 450 destinations are already reserved, data can be broadcasted to up to 50 destinations.)

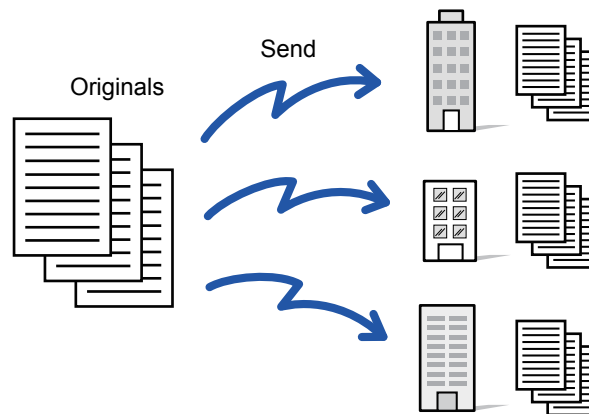

It is convenient to store destinations you frequently use for broadcast transmission as contacts or groups. A maximum of 500 destinations can be stored in one contact.

For broadcast transmission, the contact or group key can be simply tapped to retrieve multiple fax numbers.

You can also send faxes with the one-touch key by setting the [Set as Default used] checkbox to when addresses are registered. If you wish to temporarily remove a destination from the stored addresses, open the detail confirmation screen and remove the destination in the screen.

- ▶ [ADDRESS BOOK \(page 1-98\)](#)
- ▶ [STORING ADDRESSES THROUGH DIRECT ENTRY \(page 1-102\)](#)
- ▶ [STORING ADDRESSES THROUGH GLOBAL ADDRESS SEARCH \(page 1-103\)](#)
- ▶ [STORING ADDRESSES FROM FAX OR IMAGE SEND LOGS \(page 1-105\)](#)
- ▶ [STORING GROUPS \(page 1-106\)](#)



When the checkbox of "Settings (administrator)" -[System Settings] → [Image Send Settings] → [Common Settings] → [Default Settings] → [Address Book Default Selection] → [Apply Addresses of Sending Modes Only] is selected (factory default setting), the fax is only sent to those destinations that are for fax among the destinations that are set to [Set as Default used]. If the checkmark is removed , the fax can be sent to destinations of other modes.

When a one-touch key is used to dial, the number of fax numbers that are dialled is the number of destinations that are stored in the one-touch key. When a one-touch key that has 10 destinations is used, 10 fax numbers are dialled.



- Broadcast transmission is available only for memory transmission.
- If this function is combined with "Timer Transmission", broadcast transmission can be performed at any time, such as at night.
A broadcast transmission can also be used in combination with other convenient functions.
- Even if a colour original is being used, it will be sent to fax and Internet fax destinations in black and white. A long original is also sent in black and white.
- If you wish to send the same image as fax to all destinations, tap [Send Same Image as Fax Address] on the action panel.
- When Scan to E-mail and Internet Fax destinations are included, the send width for Scan to E-mail and Internet Fax will be the same as the send width for fax.
- Direct SMTP addresses cannot be included in a transmission.



1

Place the original.

Place the original in the document feeder tray of the automatic document feeder, or on the document glass.

- ▶ [AUTOMATIC DOCUMENT FEEDER \(page 1-84\)](#)
- ▶ [DOCUMENT GLASS \(page 1-86\)](#)

2

Specify all destinations.

- Entering a destination number using the numeric keys ▶ [page 4-13](#)
- Retrieving a destination from an address book ▶ [page 4-14](#)
- Using a search number to retrieve a destination ▶ [page 4-17](#)
- Retrieving a destination from a global address book ▶ [page 4-18](#)
- Using a transmission log to resend ▶ [page 4-20](#)



After entering a destination using the numeric keys, if you wish to enter another destination using the numeric keys, tap

+ before entering the next destination.

+ can be omitted before or after a destination entered using a one-touch key.

If "Be sure to press Next Address Key ([+]) before selecting the next address." is enabled in setting mode, tap **+** before specifying the next destination.

3

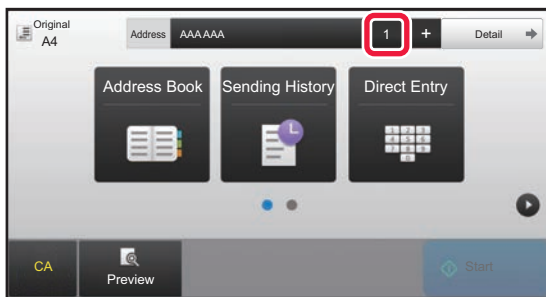

Tap the [All Destinations] key.

4

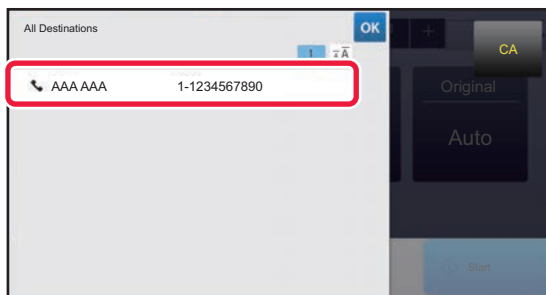

Confirm the destination.



To cancel a specified destination:

Select the address you want to cancel in the address list screen, and tap the [Delete] key.



5

Tap the [Start] key to start scanning of the original.

- If you inserted the original pages in the document feeder tray, all pages are scanned. A beep will sound to indicate that scanning and transmission have ended.
- When you place the original on the document glass, scan each page one at a time. When scanning finishes, place the next original and tap the [Start] key. Repeat the procedure until all pages have been scanned and then tap the [Read-End] key. A beep will sound to indicate that scanning and transmission have ended.



You can tap the [Preview] key to check a preview of the image before sending a fax. For more information, see "[CHECKING THE IMAGE TO BE TRANSMITTED \(page 4-30\)](#)".

RESENDING TO UNSUCCESSFUL BROADCAST TRANSMISSION DESTINATIONS

The results of a completed broadcast transmission can be checked in the job status screen. If transmission to any of the destinations failed, resend the fax to those destinations.

1

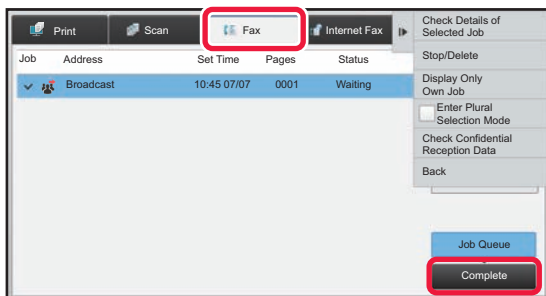

Tap the job status display, and tapping the [Fax] tab.

2

Tap the [Complete] key.



3

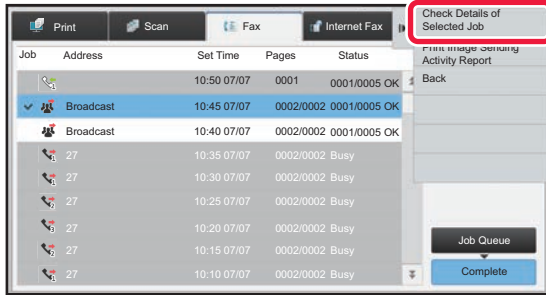

After tapping the key of the completed broadcast transmission, tap [Check Details of Selected Job] on the action panel.



If the broadcast transmission included destinations of different modes, the same broadcast transmission key will appear in each of those modes.

4

After tapping the [Failed] tab, tap [Resend to All Addresses Which Failed in Sending] on the action panel to resend the image.



The steps to follow after [Resend to All Addresses Which Failed in Sending] is tapped differ depending on whether or not the document filing function is used.

• **Using document filing:**

You will return to the document filing resend screen with the unsuccessful destinations entered. Perform the document filing resend procedure. (There is no need to re-scan the original.)

If the job was stored in a confidential folder or was stored as confidential file, a password entry screen will appear after you tap the [Retry] key. Enter the password.

• **Not using document filing:**

You will return to the base screen with the unsuccessful destinations entered. Place the original and perform the steps of the broadcast transmission.



SENDING A FAX DIRECTLY FROM A COMPUTER (PC-Fax)

A file on a computer can be sent via the machine as a fax (PC-Fax function). Faxes are sent using the PC-Fax function in the same way that documents are printed. Select the PC-Fax driver as the printer driver for your computer and then select the Print command in the application. Image data for transmission will be created and sent as a fax.

By using the "Log Viewer" application, faxes can be sent using the transmission log displayed in the Log Viewer.

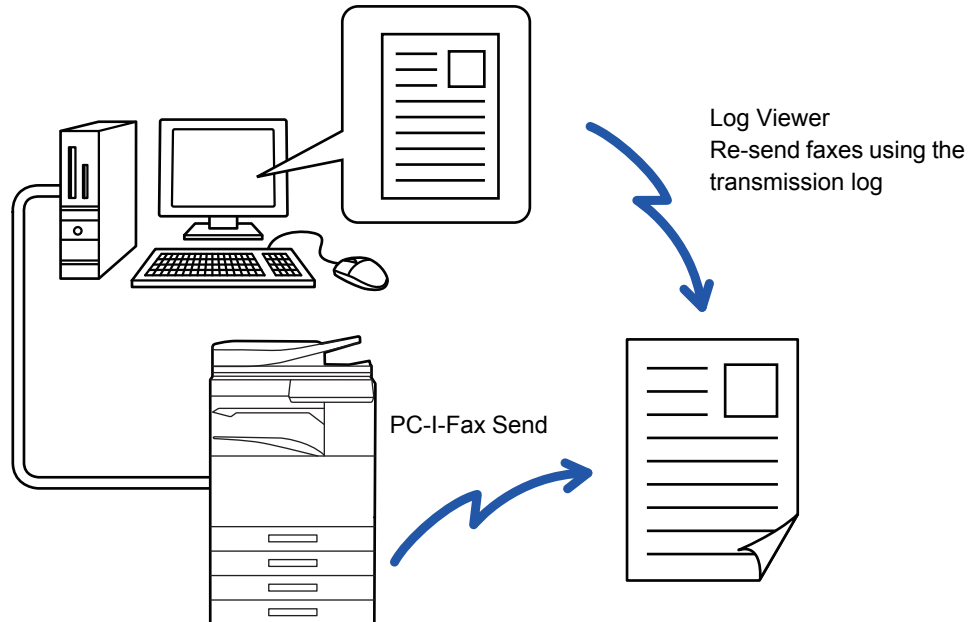

For the procedures for using this function, see the PC-Fax driver Help.



- To use the PC-Fax function, the PC-Fax driver must be installed. For more information, see the Software Setup Guide.
- This function can only be used on a Windows® computer.



Only transmission is available for this function. Faxes cannot be received by your computer.



DELETING A TRANSMISSION LOG

You can check transmission logs from the action panel of each image send mode.
You can delete an address selected in a transmission log, or delete all addresses.

Delete the Selected History

1 Tap the [Detail] key to change to normal mode.

► [Changing mode from each mode \(page 4-9\)](#)

2

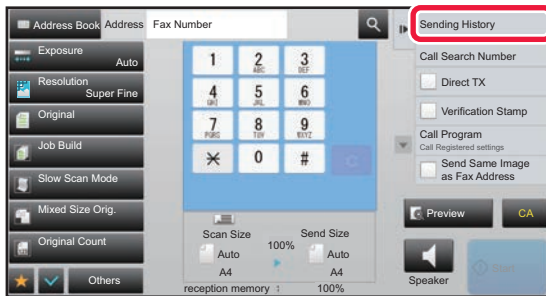

Tap [Sending History] on the action panel.

The transmission log appears.

3

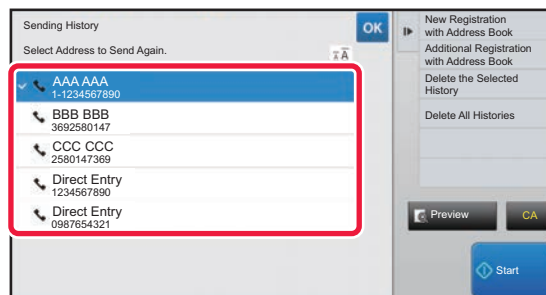

Select the address you want to delete.

4

Tap [Delete the Selected History] on the action panel.

A message appears prompting you to confirm the deletion.

5

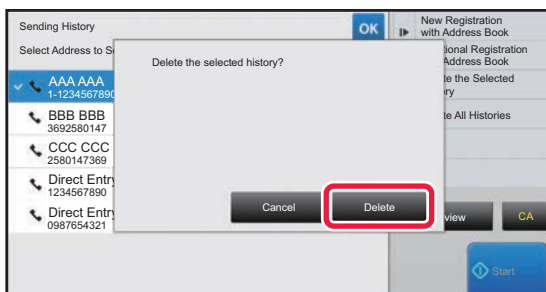

Tap the [Delete] key.



Delete All Histories

1

Tap the [Detail] key to change to normal mode.

▶ [Changing mode from each mode \(page 4-9\)](#)

2



Tap [Sending History] on the action panel.

The transmission log appears.

3

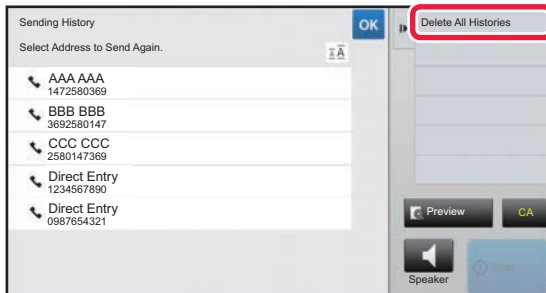

Tap [Delete All Histories] on the action panel.

A message appears prompting you to confirm the deletion.

4

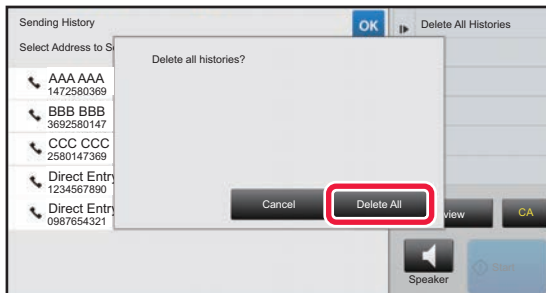

Tap the [Delete All] key.



SET THE SCANNING OF THE ORIGINALS

AUTOMATICALLY SCANNING BOTH SIDES OF AN ORIGINAL (2-Sided Original)

The automatic document feeder will automatically scan both sides of the document.

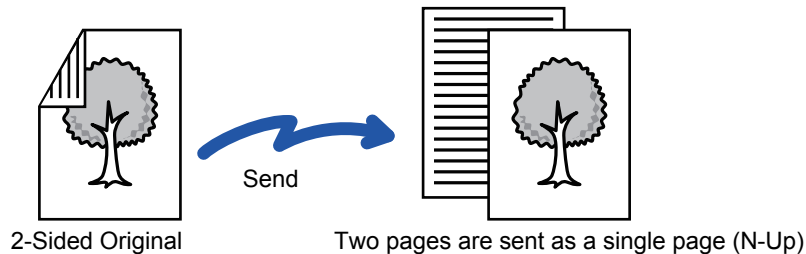

- 2-sided scanning is not possible when direct transmission or speaker transmission is performed.
- On the MX-2630N/MX-3050V/MX-3060V/MX-3550V/MX-3560V/MX-4050V/MX-4060V/MX-5050V/MX-6050V, duplex scanning is not possible when originals of mixed width are scanned.
- You cannot use 2-sided scanning when the original size is set to Long Size.



2-sided scanning automatically turns off after transmission has ended.

1

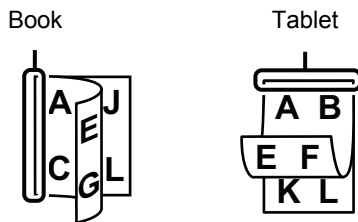

Tap the [Original] key, and tap the [Book] key or [Tablet] key.

See the figure on the left to check the binding edge of the original and select the key to be tapped.



In normal mode, tap the [2-Sided Booklet] key or [2-Sided Tablet] key.

2

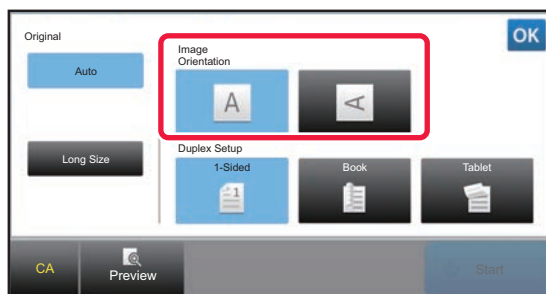

Tap the [Image Orientation] key with the same orientation as the placed original.

If this setting is not correct, a suitable image may not be transmitted.

After the settings are completed, tap **OK**.



To cancel 2-sided scanning:

Tap the [1-Sided] key.

In normal mode, tap the [2-Sided Booklet] key or the [2-Sided Tablet] key that has been forcibly displayed and cancel the display.



AUTO DETECTION

When the original is placed, its size is automatically detected.

In normal mode, the size of the placed original is shown as the "Scan Size" and the transmission size is shown as the "Send Size" in the initial screen.

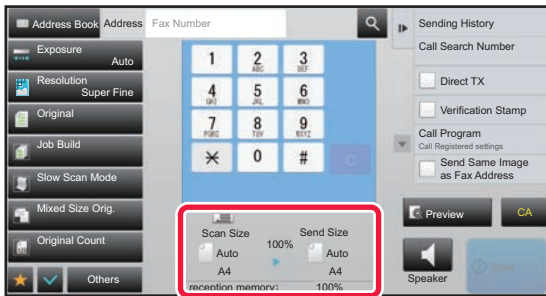

In the above screen, the scan size (the placed original) is A4 (8-1/2" x 11") and the send size is auto. For example, if the scan size is A4 (8-1/2" x 11") and the send size is B5 (5-1/2" x 8-1/2"), the image will be reduced before transmission.

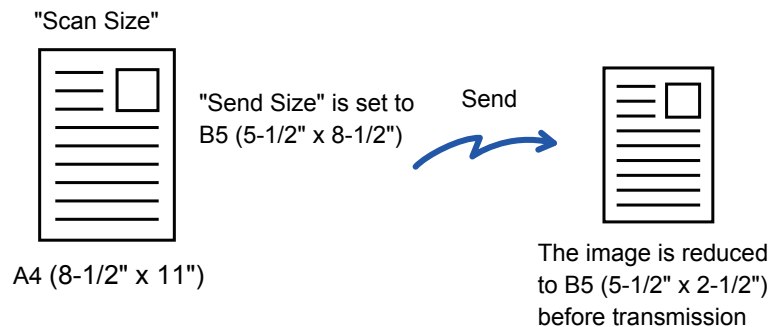

- Only standard original sizes can be automatically detected.
 - ▶ [Standard sizes \(page 2-11\)](#)
- When the original size is an inch size or a non-standard size, or if the size is not detected correctly, manually specify the original scan size.
 - ▶ [SPECIFYING THE ORIGINAL SCAN SIZE IN PAPER SIZE \(page 4-47\)](#)
 - ▶ [SPECIFYING THE ORIGINAL SCAN SIZE USING NUMERIC VALUES \(page 4-48\)](#)



SPECIFYING THE ORIGINAL SCAN SIZE IN PAPER SIZE

When the original size is not standard (inch size or non-standard size) or is not detected correctly, manually specify the original size.



When [Long Size] is selected, the 2-sided scanning setting and send size cannot be changed. The image is sent in Mono2 only.

1

Tap the [Detail] key to change to normal mode.

▶ [Changing mode from each mode \(page 4-9\)](#)

2

Tap the [Original] key.

3

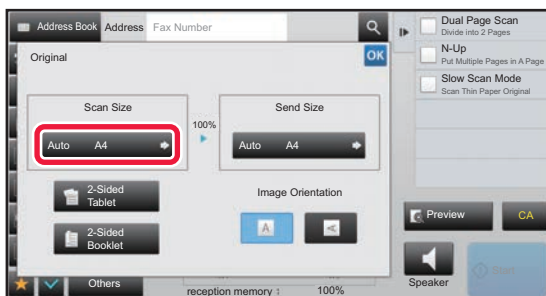

Tap the [Scan Size] key.

4

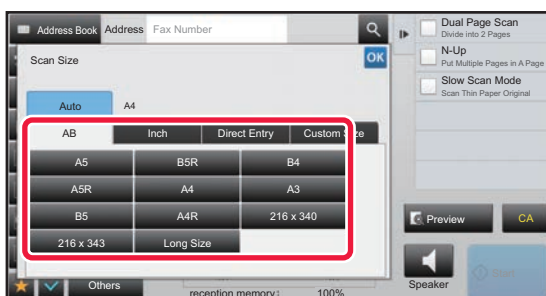

Tap the appropriate original size key.

After the settings are completed, tap **OK**.



- If you are sending a long original, tap the [Long Size] key.

Use the automatic document feeder to scan a long original. The maximum width that can be scanned is 1,000 mm (39-3/8") (the maximum height is 297 mm (11-5/8")).

▶ [TRANSMITTABLE ORIGINAL SIZES \(page 4-26\)](#)



SPECIFYING THE ORIGINAL SCAN SIZE USING NUMERIC VALUES

When scanning a non-standard size original such as a postcard, specify the original size by numeric values after placing the original. The width can be from 25 mm to 432 mm (1" to 17"), and the height can be from 25 mm to 297 mm (1" to 11-5/8").



When the scan size is specified by numeric values, the send size cannot be specified.

1

Tap the [Detail] key to change to normal mode.

▶ [Changing mode from each mode \(page 4-9\)](#)

2

Tap the [Original] key.

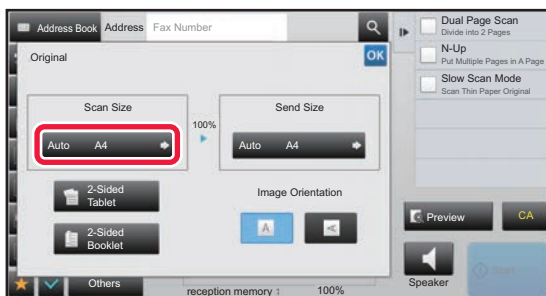
3

Tap the [Scan Size] key.

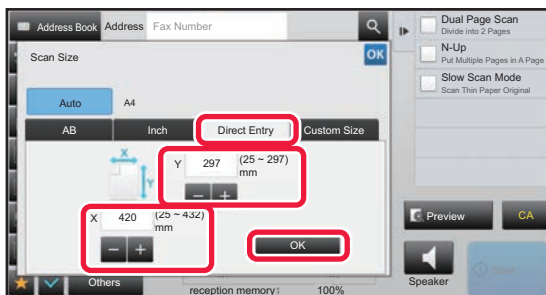
4

Tap the [Direct Entry] key, and enter the scan size.

- Tap the areas displaying width and height sizes respectively, and enter the sizes using the numeric keys.
- It is convenient to use **- +** to finely adjust the entered size.

5

Tap the [OK] key.

After the settings are completed, tap **OK** twice.

On the base screen, check that the specified size is displayed on the [Original] key.



To cancel the specified size settings:

Tap the [Auto] key.



STORING FREQUENTLY USED ORIGINAL SIZES

Store the frequently used non-standard original sizes. This section explains how to store, retrieve, change, and delete non-standard original sizes.



- The stored original size will be retained even if the main power is turned off.
- A total of up to 12 non-standard original sizes can be registered for copying, fax, and image sending.
- The added original sizes will also appear in other modes.

Storing original sizes (Amend/Delete)

1

Tap the [Detail] key to change to normal mode.

► [Changing mode from each mode \(page 4-9\)](#)

2

Tap the [Original] key.

3

Tap the [Scan Size] key and tap the [Custom Size] tab.

4

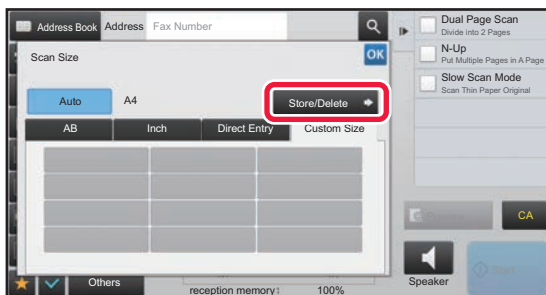

Tap [Store/Delete] key.



5

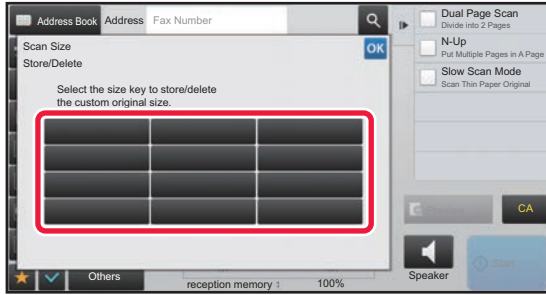

Tap a key () for storing a custom original size.

Tap a key that does not show a size.



To amend or delete a previously stored key:

Tap the key that you want to amend or delete. The following screen will appear.

- To amend the key, tap the [Amend] key and go to the next step.
- To delete the key, tap the [Delete] key. Make sure that the original size has been cleared and tap the [OK] key.

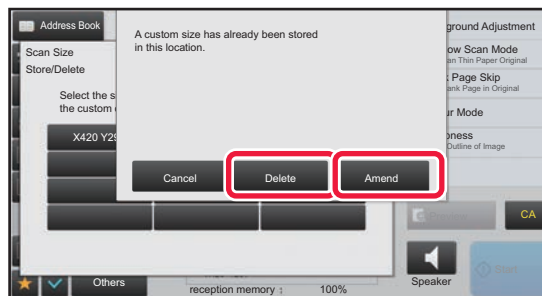

6

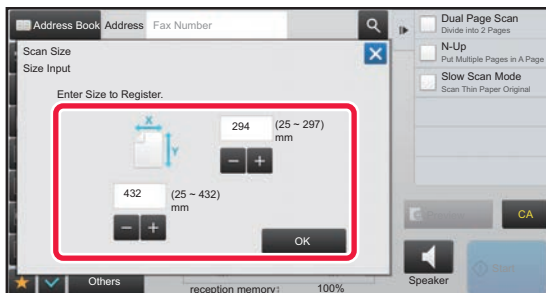

Specify the original size.

Tap the areas displaying width and height sizes respectively, and enter the sizes using the numeric keys.



It is convenient to use **- +** to finely adjust the entered size.

7

Tap the [OK] key.

Tap the [OK] key, and check that the key of the size stored on the Scan Size screen is added properly. After you have checked it, tap [OK].



To cancel the operation:

Tap the [CA] key.



Retrieving a stored original size

1 Tap the [Detail] key to change to normal mode.

► [Changing mode from each mode \(page 4-9\)](#)

2 Tap the [Original] key.

3 Tap the [Scan Size] key and tap the [Custom Size] tab.

4

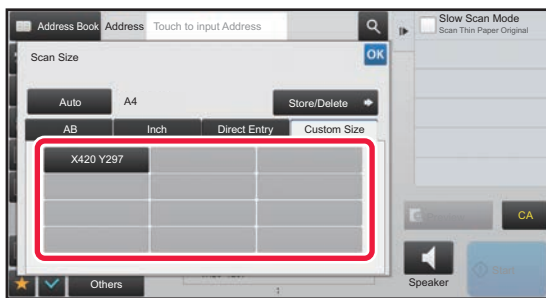

Tap the key of the original size that you wish to retrieve.

After selecting the key of the original size, tap the **OK** key. Check that the specified size is displayed on the scan size screen.



To cancel the operation

Tap the [CA] key.



SPECIFYING THE SEND SIZE OF THE IMAGE

Tap this key to specify the send size as a paper size. If the specified send size is larger than the scan size, the image will be enlarged. If the specified send size is smaller than the scan size, the image will be reduced.



The send size cannot be specified when [Long Size] is selected for the scan size, or when the scan size is specified by numeric values.

1

Tap the [Detail] key to change to normal mode.

▶ [Changing mode from each mode \(page 4-9\)](#)

2

Tap the [Original] key.

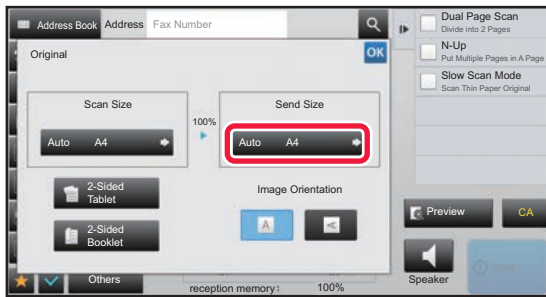
3

Tap the [Send Size] key.

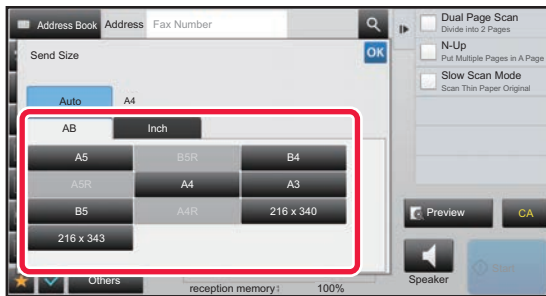
4

Tap the desired send size key.

After the settings are completed, tap **OK**.



Depending on the paper size specified for the "Scan Size", it may not be possible to select some sizes for the "Send Size". You cannot tap size keys that are unavailable for the "Send Size".



5

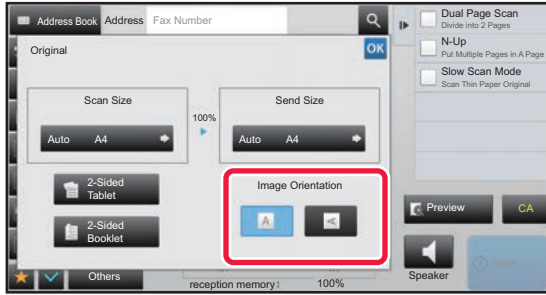

Tap the [Image Orientation] key with the same orientation as the placed original.

If this setting is not correct, a suitable image may not be transmitted.

After the settings are completed, tap **OK**.



To configure the default setting of image orientation:

Select [System Settings] → [Image Send Settings] → [Common Settings] → [Condition Settings] → [Image Orientation] in "Settings (administrator)".



The ratio used for reduction or enlargement of the original will appear between the "Scan Size" and the "Send Size".



CHANGING THE EXPOSURE

The exposure can be changed to suit the darkness of the original.



When using the automatic document feeder, the exposure setting cannot be changed once scanning has begun. (However, when "Job Build" or "Preview Setting" in "Others" is used, the exposure can be changed each time a new set of originals is inserted.)

Exposure settings

Exposure		Suggestion
Auto		This setting automatically adjusts the exposure for light and dark parts of the original.
Manual	1-2	Select this setting when the original consists of dark text.
	3	Select this setting for a normal original (neither dark nor light).
	4-5	Select this setting when the original consists of light text.

1

After tapping the [Exposure] key, tap the [Manual] key.

2

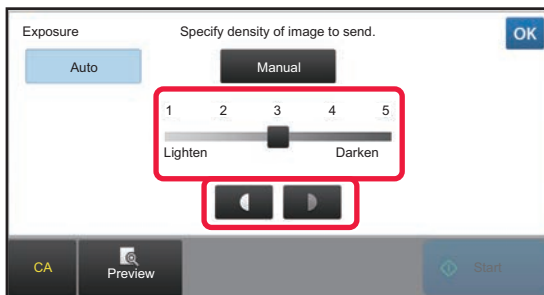

Adjust the exposure with the slider or



After the adjustment, tap **OK**.



When [Auto] is selected, the exposure will be set to "3".



CHANGING THE RESOLUTION

The resolution can be specified to match the characteristics of the original, such as text or photo, the size of the text, and the darkness of the image.

Resolution settings

Resolution	Suggestion
Standard	Select this setting when your original consists of normal-sized text (like the text in this manual).
Fine	Select this setting when your original has small text or diagrams with fine lines. The original will be scanned at twice the resolution of the [Standard] setting.
Super Fine	Select this setting when your original has intricate pictures or diagrams. A higher-quality image will be produced than with the [Fine] setting.
Ultra Fine	Select this setting when your original has intricate pictures or diagrams. This setting gives the best image quality. However, transmission will take longer than with the other settings.
Half Tone	Select this setting when your original is a photograph or has gradations of colour (such as a colour original). This setting will produce a clearer image than [Fine], [Super Fine], or [Ultra Fine] used alone. Halftone cannot be selected when [Standard] is used.



- When using the automatic document feeder, the resolution setting cannot be changed once scanning has begun. (However, when "Job Build" or "Preview Setting" in "Others" is used, the resolution can be changed each time a new set of originals is inserted.)
- When a fax is sent at [Ultra Fine], [Super Fine], or [Fine] resolution, a lower resolution will be used if the receiving machine does not have that resolution.

1

Tap the [Resolution] key.

2

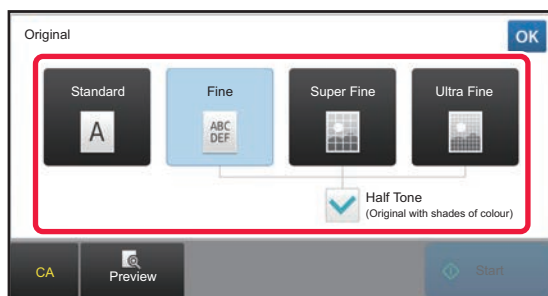

Tap the key of the desired resolution.

When your original is a photograph or has gradations of colour (such as a colour original), and you wish to produce a clearer image than [Fine], [Super Fine], or [Ultra Fine] used alone, set the [Half Tone] checkbox to . Halftone cannot be selected when [Standard] is used. After the settings are completed, tap **OK**.



FAX RECEPTION

This section explains how to enter a destination from the initial screen of easy mode.



► [SELECTING FAX MODE \(page 4-8\)](#)

RECEIVING A FAX

RECEIVING A FAX AUTOMATICALLY

When the reception mode is set to "Auto Reception", the machine will receive and print faxes automatically.



- When fax reception is in progress, it is possible to reserve a transmission by performing the transmission in memory transmission mode.
 - [FAX TRANSMISSION METHODS \(page 4-23\)](#)
- The Data Notification indicator blinks from the start of fax reception until printing is completed. When output is delivered to the job separator (upper tray), the indicator blinks until printing is completed and the output is removed from the tray.
- To print received faxes, make sure that the required paper is loaded into the machine's paper trays. It is not necessary to load A4 (8-1/2" x 11") paper and B5 (5-1/2" x 8-1/2") paper in both the vertical () and horizontal () orientations. Differences in orientation are automatically adjusted when faxes are received. When a fax smaller than A4 (8-1/2" x 11") size is received, the size of the paper used for printing will vary depending on the orientation (vertical or horizontal) in which the sender placed the original.
- If a print job such as the copy or printer function has already been executed when printing the received data, the first reserved job is printed before the received data.
- Received faxes will not be printed when the machine cannot print due to an error condition such as out of paper, out of toner, or a paper misfeed. The faxes will be printed automatically when the error condition is cleared. (If the paper has run out, add paper and tap **OK** on the touch panel.)
- You can check current fax reception mode in the system area at the top of the screen.



To switch between auto reception and manual reception modes:

Select [System Settings] in "Settings (administrator)" → [Image Send Settings] → [Fax Data Receive/Forward (Manual)] → [Fax Settings] → [Receive Settings].

1

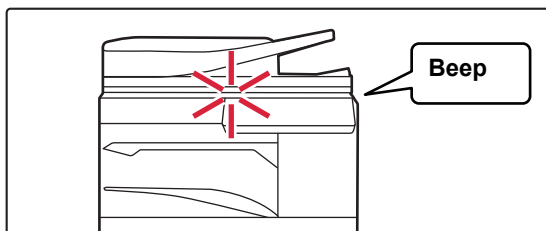

The machine rings and fax reception begins automatically.

When reception begins, the Data Notification indicator blinks.

A beep sounds when reception ends.



2

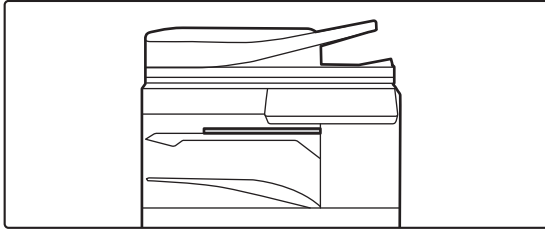

The faxes are printed automatically.

When printing ends, the Data Notification indicator turns off. When the job separator (upper tray) is used for output, this blinks until the output is removed.



If a PIN Code entry screen appears:

A PIN Code is registered to print the received fax data. When the correct PIN Code is entered, the received fax is printed.

► [PRINTING A PIN CODE-PROTECTED FAX \(Hold setting for received data print\) \(page 4-59\)](#)

How to check the fax reception mode

You can check current fax reception mode in the system area at the top of the screen.

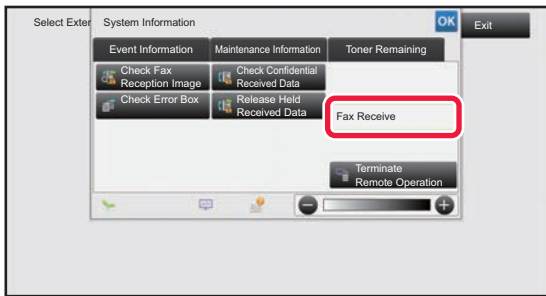



RECEIVING A FAX MANUALLY

A fax can be received manually using the touch panel (manually).



- When answering the telephone by tapping the [Speaker] key, you will be able to hear the voice of the caller, but you will not be able to speak.
- You can receive a fax after answering a call on an extension telephone. Remote reception can also be used to receive a fax.
 - ▶ [RECEIVING A FAX AFTER ANSWERING A CALL ON THE EXTENSION TELEPHONE \(REMOTE RECEPTION\)](#) (page 4-123)



To switch between auto reception and manual reception modes:

Select [System Settings] in "Settings (administrator)" → [Image Send Settings] → [Fax Data Receive/Forward (Manual)] → [Fax Settings] → [Receive Settings].

1

When the machine rings, tap the [Detail] key to change to normal mode, and tap the [Speaker] key.

When the [Speaker] key is tapped, the [Receive] and appears.

- ▶ [Changing mode from each mode \(page 4-9\)](#)



- To adjust the speaker volume, tap the key and adjust with the slider or **- +** keys.
- If the received fax data remains unprinted, it will cause the fax memory to fill up, which may prevent some faxes from being received. When using this function, you should print the received data as soon as possible without leaving it in the fax memory.

You can view the remaining fax memory capacity on the fax mode base screen.

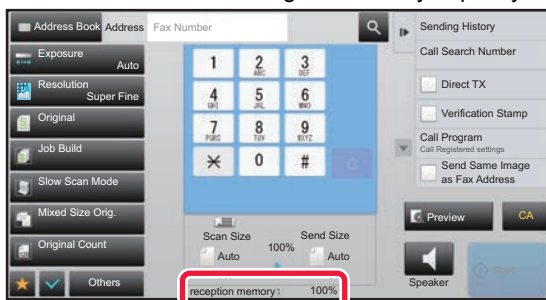

2

Tap the [Receive] key to receive a fax.

When printing ends, the Data Notification indicator turns off. When the job separator (upper tray) is used for output, this blinks until the output is removed.

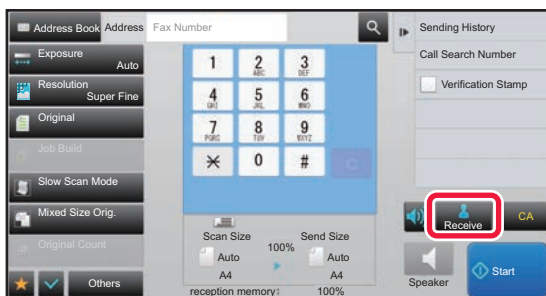



PRINTING RECEIVED DATA

PRINTING A PIN CODE-PROTECTED FAX (Hold setting for received data print)

Enable this setting to have faxes received and stored in memory without being printed. To print the faxes, a PIN Code must be entered. When this function is used, a PIN Code entry screen appears in the touch panel when a fax is received.

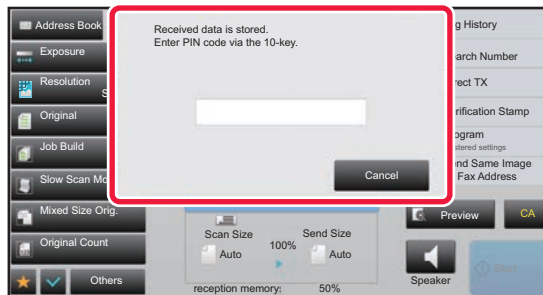

To enable the hold setting for received data print:



In "Settings (administrator)", select [System Settings] → [Image Send Settings] → [Common Settings] → [Condition Settings] → [Hold Setting for Received Data Print].

Important points when using this function

If the received fax data is not printed or deleted, the fax memory will run low, and the machine will not be able to receive any faxes. When using this function, you should print the received data as soon as possible without leaving it in the fax memory.

You can view the remaining fax memory capacity on the fax mode base screen.

When little space remains in the fax memory, "Manual receive is disabled. Due to out of memory." appears on the touch panel.



- The received faxes will be stored in memory regardless of whether they are received automatically or manually.
- When the received data is transferred to other machine, data stored in memory is also transferred. At that time, the same PIN Code entry screen will appear as for printing. Forwarding will not take place unless the PIN Code is entered.

When the previously programmed 4-digit PIN Code is entered using the numeric keys, printing begins.

When the [Cancel] key is tapped, the PIN Code entry screen closes. It will reappear when you tap  or change modes. The data in memory key will blink in the touch panel.



To display the received data list screen after entering the PIN Code:

In "Settings (administrator)", select [System Settings] → [Image Send Settings] → [Common Settings] → [Condition Settings] → [Preview Setting] → [Received Data Image Check Setting].



PRINTING RECEIVED DATA AT A SPECIFIED TIME

You can start printing the received data at a specified time.

For stress-free printing, you should avoid printing large numbers of pages at peak times during the day, and when you do not urgently need to print.

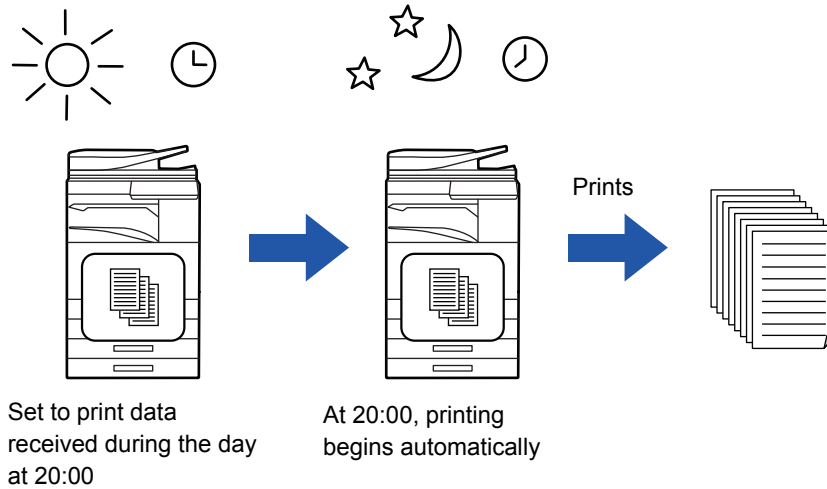

- The printed data is automatically deleted from memory.
- If the power is turned off at the specified time, printing will start at the timing when the power is turned on.
- This function can be used when "Settings (administrator)" - [System Settings] → [Image Send Settings] → [Common Settings] → [Condition Settings] → [Preview Setting] → [Received Data Image Check Setting] is enabled.



If Hold Setting for Received Data Print is enabled, this function is not available.



• **To print received data at the specified time:**

In "Settings", select [System Settings] → [Image Send Settings] → [Common Settings] → [Condition Settings] → [Time Specified Output of Received Data].

• **To disable the hold setting for received data print:**

In "Settings (administrator)", disable this function using [System Settings] → [Image Send Settings] → [Common Settings] → [Condition Settings] → [Hold Setting for Received Data Print].



CHECKING THE IMAGE BEFORE PRINTING

Check the image of received data on the touch panel before printing.

This function can be used when "Settings (administrator)" - [System Settings] → [Image Send Settings]

→ [Common Settings] → [Condition Settings] → [Preview Setting] → [Received Data Image Check Setting] is enabled*.

* The factory default setting is disabled.

Important points when using this function

If the received fax data is not printed or deleted, the fax memory will run low, and the machine will not be able to receive any faxes. When using this function, you should print the received data as soon as possible without leaving it in the fax memory.

You can view the remaining fax memory capacity on the fax mode base screen.

When data is received, is shown at the top of the screen.

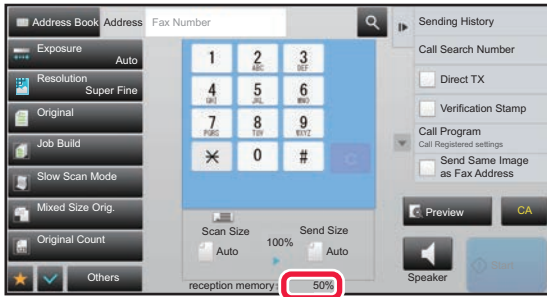

Depending on the size of the received data, part of the check image on the touch panel may not appear.

The received data list can be also shown in the job status screen that appears when you tap the job status display.

The received data can be forwarded, deleted, or saved from the received data list.

- ▶ [FORWARDING RECEIVED DATA MANUALLY \(page 4-69\)](#)
- ▶ [SAVING RECEIVED DATA \(page 4-71\)](#)

1

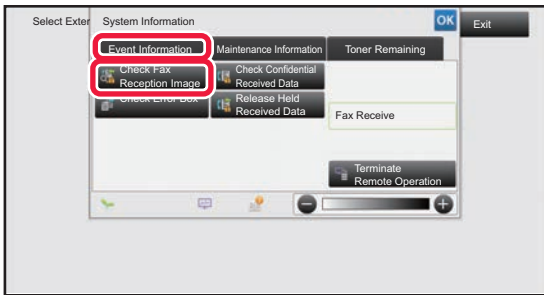

In the System Information, tap the [Event Information] tab and tap the [Check Fax Reception Image] key.

The received data is listed.



You can also display the received data list by tapping the job status display and tapping [Check Received Data] on the action panel of Job Status screen.



2

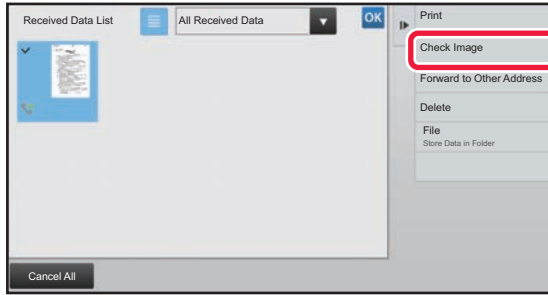

Tap the key of the received data you wish to check, and tap [Check Image] on the action panel.

Displays the received data image.



- Tap to show a list of received data. The list view or thumbnails view can be changed depending on the setting mode.
- To delete a received image, tap [Delete] on the action panel.
- To transfer the selected received image, tap [Forward to Other Address] on the action panel.
 - ▶ [FORWARDING RECEIVED DATA MANUALLY \(page 4-69\)](#)
- To save the selected received image, tap [File] on the action panel.
 - ▶ [SAVING RECEIVED DATA \(page 4-71\)](#)
- To store the sender fax number as a number for "Allow/Reject Number Setting", tap [Register as Junk Fax] on the action panel and, in the confirmation message screen, tap the [OK] key.
Specify a sender fax number as a number for "Allow/Reject Number Setting" by selecting, in "Settings (administrator)", select [System Settings] → [Image Send Settings] → [Fax Settings] → [Receive Settings] → [Allow/Reject Number Setting].

3



Tap the image you wish to print, and tap the [Print] on the action panel.

The machine starts printing the image.

- [Select All Page]: Selects all displayed images.
- [Release All Page]: Cancels all images that have been selected by "Select All Page".
- / : Use these keys to enlarge or reduce an image.
- / : Rotates image counterclockwise or clockwise.



- A preview image is an image for the touch panel. It will differ from the actual print result.
- Tap [Erase Specified Range] on the action panel to delete unwanted area of the image. Specify the image area you wish to delete in the Erase Specified Range screen.
- To forward the selected image, tap [Forward to Other Address] on the action panel.
 - ▶ [FORWARDING RECEIVED DATA MANUALLY \(page 4-69\)](#)
- To save the selected received image, tap [File] on the action panel.
 - ▶ [SAVING RECEIVED DATA \(page 4-71\)](#)



FORWARDING RECEIVED DATA

FORWARDING RECEIVED FAXES (FAX DATA FORWARD)

When the machine cannot print because it is out of paper or out of toner, received faxes can be forwarded to another previously stored fax machine. Store a recipient by selecting [\[Set the Telephone Number for Data Forwarding \(page 7-186\)\]](#) in Setting mode.

When printing ends, the Data Notification indicator turns off.

This function is convenient in an office or work area that has two or more telephone lines and another fax machine is connected to a different line than the machine.

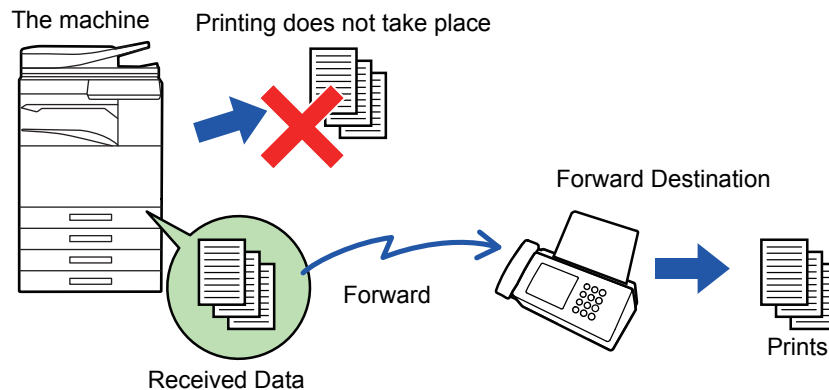

- If some pages of a fax that is being forwarded were successfully printed, only those pages that were not printed will be forwarded.
- A forwarded fax becomes a fax transmission job. If transmission does not take place because the transmission was cancelled or an error occurred, the fax will be held in memory until it can be printed.
- All faxes received are forwarded. Note, however, that faxes received and stored in an F-code confidential memory box cannot be forwarded.
- If a PIN Code entry screen appears after tapping the [OK] key, "Hold Setting for Received Data Print" has been enabled. Enter the PIN Code using the numeric keys to begin forwarding.
 - ▶ [PRINTING A PIN CODE-PROTECTED FAX \(Hold setting for received data print\) \(page 4-59\)](#)

1

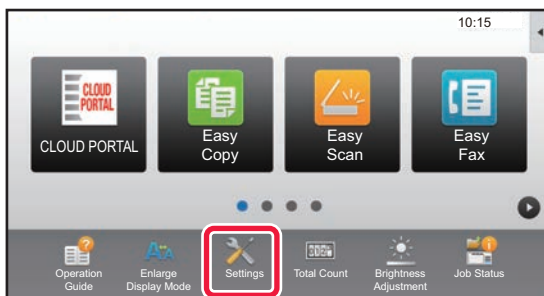

Make sure that the Data Notification indicator is blinking, and tap the [Settings] key in the home screen.

2

Tap the [System Settings] → [Image Send Settings] → [Fax Data Receive/Forward (Manual)] key.



3

Tap the [Execute] key in [Forward Received Data] to begin forwarding.



If a PIN Code entry screen appears, the "Hold Setting for Received Data Print" has been enabled. Enter the PIN Code using the numeric keys to begin forwarding.

► [PRINTING A PIN CODE-PROTECTED FAX \(Hold setting for received data print\) \(page 4-59\)](#)

FORWARDING RECEIVED DATA TO PRESET DESTINATIONS (INBOUND ROUTING SETTINGS)

You can have received faxes automatically forwarded to a fax address, Internet fax address, e-mail address, file server address, desktop address, or network folder address. Received data can be forwarded to the specified destinations without being printed.

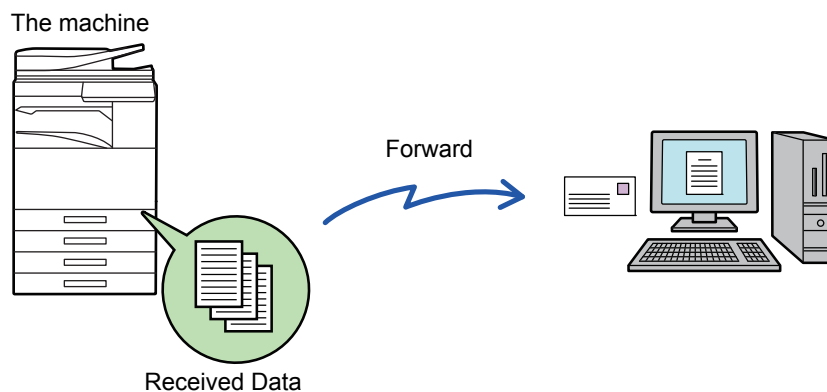

Configure all forwarding settings for received faxes in setting mode (Web version). For the procedure for accessing the setting mode (Web version), see Quick Start Guide.

The following explanation assumes that the setting mode (Web version) has been accessed with administrator rights.



Whether or not to forward data for each forwarding table can be quickly set.

In "Settings (administrator)" - [System Settings] → [Image Send Settings] → [Inbound Routing (Forwarding/Storing) Settings] → [Administration Settings] → [Inbound Routing], tap [Enable]/[Disable] for each forwarding table that appears.



- This function cannot be used for faxes received by confidential reception.
- When faxes forwarded using this function are printed at the forwarding destination, the date and time of reception cannot be printed on the faxes. ("Receiving Date & Time Print" is disabled.)
- The received data is not forwarded to a hyperlink destination that is registered in the specified address.
- A direct SMTP address cannot be specified as a forwarding destination.

1

In "Settings (Web version)", click [System Settings]

→ [Image Send Settings] → [Inbound Routing (Forwarding/Storing) Settings]

→ [Administration Settings].



2

In "Inbound Routing", select [Enable] and click the [Submit] button.



Users without administrator rights can be prohibited from storing, editing, and deleting forwarding tables in this screen, and from specifying which table is used. To do so, set the checkboxes for the following items to .

- Disable Registration of Forward Table
- Disable Change/Delete of Forward Table
- Disabling of Forward Condition Change

Specify in [Print Style Setting] whether or not to have the machine to print the faxes to forward when inbound routing is enabled. After the settings are completed, be sure to click the [Submit] button.

- [Always Print]: Always prints received data before forwarding the data.
- [Print at Error]: Prints received data only when an error prevents forwarding.
- [Save Only at Error]: Saves received data only when an error prevents forwarding. For the saved data, the error address can be confirmed and the data can be resent. From the [Scan] or [Fax] tab in the job status screen, tap [Check Error Box] on the action panel.

3

Click [Sender Address Registration] in the [Inbound Routing (Forwarding/Storing) Settings] menu in the "Settings (Web version)".

4

Enter the sender address or fax number in "Internet Fax Address" or "Fax Number" as appropriate, and click the [Add to List] button.

The entered address will be added to the "Address to be Entered" list. Enter the address directly (maximum of 1500 characters) or select the address from a global address book by clicking the [Global Address Search] button. To store multiple sender addresses or fax numbers, repeat these steps.



- If you wish to have only faxes from specified addresses forwarded, store the desired sender addresses. Send addresses stored here can be selected from a list when you store a forwarding table.
- A maximum of 500 sender numbers/addresses can be stored.
- To delete an entered address, select the address in "Address to be Entered" and click the [Delete] button.

5

When you have finished adding addresses, click the [Submit] button.

6

Click [Inbound Routing Settings] in the [Inbound Routing (Forwarding/Storing) Settings] in the "Settings (Web version)" menu and click the [Add] button.

7

Enter a "Table Name".



8

Select the sender whose faxes will be forwarded.

- To forward all received data, select [Forward All Received Data].
- To forward only data received from specific senders, select [Forward received data from specified senders only.]. To forward all data except data from specific senders, select [Forward all received data except that from specified senders.]. Then, select the appropriate senders from the list and click the [Add] button.



When selecting senders from the "Sender Address Setting" list, you can use the [Shift] key or the [Ctrl] key on your keyboard to select multiple senders.

9

Select the forwarding conditions.

- To always forward received data, select [Always Forward].
- To specify a day and time on which received data will be forwarded, select [Forward received data only on specified days.] and select the checkbox of the desired day of the week. To specify a time, select the [Set Forwarding Time] checkbox () and specify the time.



Up to three forwarding day and time settings can be set for one forwarding table, and a forwarding destination can be set for each set time. To configure these settings, use the [Forward Condition] tabs to access each setting.

10

Select the file format.

The format can be set separately for each forwarding address (for each of forwarding addresses 1, 2, and 3 in the table).



- Images forwarded in TIFF format may not be displayed correctly in some recipient environments. In this event, change the file format to PDF.
- If the Internet fax address is selected as a recipient, data is forwarded in TIFF regardless of the specified format.
- If a fax number is selected as a recipient, the file format is ignored.

11

Select the recipient from the address book.

You can specify multiple registered addresses or telephone numbers from the address book of the machine.

Up to 1,000 recipients can be registered for Recipients 1, 2, and 3 in total.

When you select the recipients from the address book, up to 400 recipients can be registered for network folder, FTP/Desktop, Internet fax, and fax.



A direct SMTP address cannot be specified as a forwarding destination.

12

Enter a recipient directly and specify the recipient.

- Specify this information if necessary.
- Enter an e-mail address, an Internet fax address, or a fax number directly and tap the [Add] key.
- When you specify an e-mail address or a fax number, you can use the global address search.
- When you specify a fax number, also specify the international correspondence mode.
- When enter the recipients directly, up to 100 recipients can be registered for e-mail address, network folder, FTP/Desktop, Internet fax, and fax.



13 Click [Submit].

14 Click [Inbound Routing Settings] in the [Inbound Routing (Forwarding/Storing) Settings] in "Settings (Web version)".

15 From the forwarding table, select [Forward to All Forward Destinations] or [Forward based on Forward Condition].

16 From the forwarding table, select [Always Forward] or [Forward received data only on specified days.].

The forwarding permission settings that appear here are linked to the forwarding conditions set in step 9.
If you wish to use different forwarding conditions than those set in step 9, set the forwarding permission settings.



- To use the inbound routing function, enable the forwarding tables that you wish to use from among the stored tables.
 - To delete a forwarding table, click the checkbox next to the table name so that it is selected () and click [Delete].
-

17 Click [Submit].



SAVING RECEIVED FAXES TO THE MACHINE'S HARD DISK (INBOUND ROUTING)

Received faxes can be saved to the machine's hard disk. Saved faxes can be viewed on a computer.

Set PDF, TIFF (multi) or TIFF (signal) for the saved Internet faxes.

You can also receive notification of the storage result or storage folder by E-mail.

Received faxes are saved in the following directory:

\\MFP\faxreceive

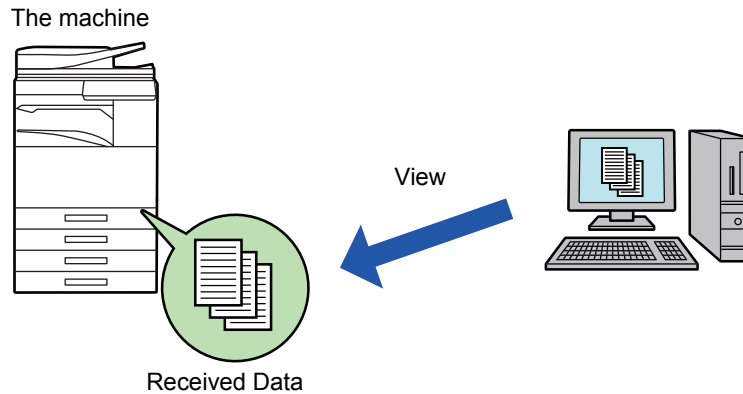

- Up to 500 files can be stored in one folder as received data.
- The "faxreceive" folder contains files of "Settings for HDD Storing of Received Data".
- The folder is automatically created.
- The file name for received data can be set in "File Name Setting" in "Settings for HDD Storing of Received Data" in "Inbound Routing (Storage) Settings".

How to save received faxes to the hard disk

1 In "Settings (administrator)", click [System Settings] → [Network Settings] → [Public Folder / NAS Setting]. (Administrator rights required.)

2 Select [Allowed] in "faxreceive:Use of Storage" and click the [Submit] button.



Settings for saving received faxes to the hard disk

- 1 In "Settings (administrator)", click [System Settings] → [Image Send Settings] → [Inbound Routing (Forwarding/Storing) Settings] → [Inbound Routing (Storage) Settings] (administrator rights are required).



- Data that can be saved are received faxes and received Internet faxes. Confidential reception and polling reception faxes cannot be saved.
- Depending on the setting, received faxes that cannot be saved because of the file number limit or other reason are either printed or saved in the inbound routing error box.

FORWARDING RECEIVED DATA MANUALLY

Received faxes can be forwarded manually after receipt.

This function is available when [System Settings] → [Image Send Settings] → [Common Settings] → [Condition Settings] → [Preview Setting] → [Received Data Image Check Setting] is enabled* in "Settings (administrator)".

* The factory default setting is disabled.

When data is received,  is shown at the top of the screen.

- 1

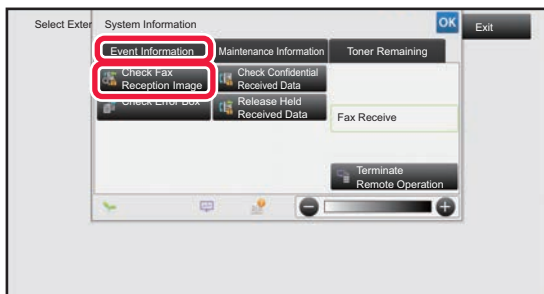

In the System Information, tap the [Event Information] tab and tap the [Check Fax Reception Image] key.

The received data is listed.



You can also display the received data list by tapping the job status display and tapping [Check Received Data] on the action panel of Job Status screen.



2

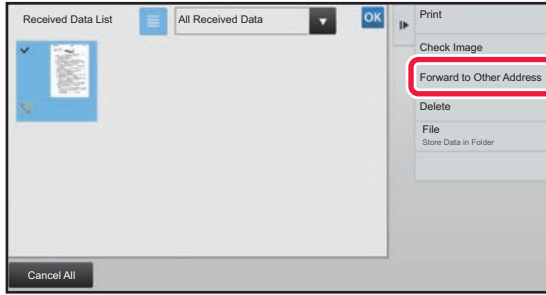

Tap the key of the received data you wish to forward, and tap [Forward to Other Address].

- Tap  to show a list of received data. The list view or thumbnails view can be changed depending on the setting mode.
- Multiple sets of received data can be selected.



- When you select a single received data only, you can tap [Check Image] on the action panel and check the image on the preview screen.
- To store the sender fax number as a number for "Allow/Reject Number Setting", tap [Register as Junk Fax] on the action panel and, in the confirmation message screen, tap the [Store] key.
- Specify a sender fax number as a number for "Allow/Reject Number Setting" by selecting, in "Settings (administrator)", select [System Settings] → [Image Send Settings] → [Fax Settings] → [Receive Settings] → [Allow/Reject Number Setting].

3

Select the destination from the Address Book screen, and tap the [Start] key.



SAVING RECEIVED DATA

You can save received faxes in the document filing folder.

This function is available when [System Settings] → [Image Send Settings] → [Common Settings] → [Condition Settings] → [Preview Setting] → [Received Data Image Check Setting] is enabled* in "Settings (administrator)".

* The factory default setting is disabled.

Received data in the memory

Stored in the document filing folder

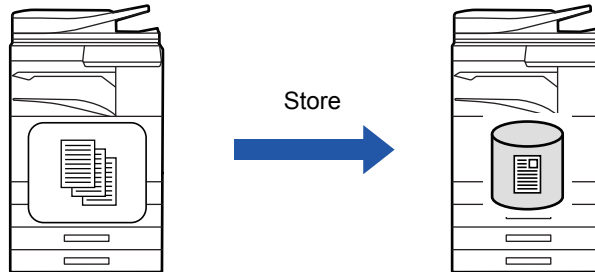

When data is received,  is shown at the top of the screen.

1

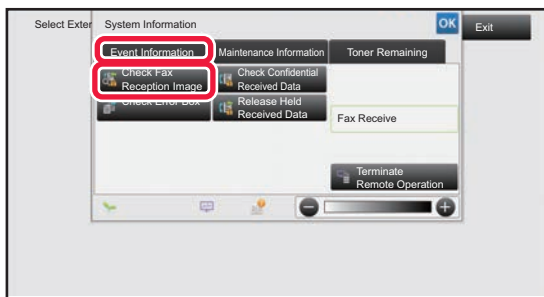

In the System Information, tap the [Event Information] tab and tap the [Check Fax Reception Image] key.

The received data is listed.



You can also display the received data list by tapping the job status display and tapping [Check Received Data] on the action panel of Job Status screen.

2

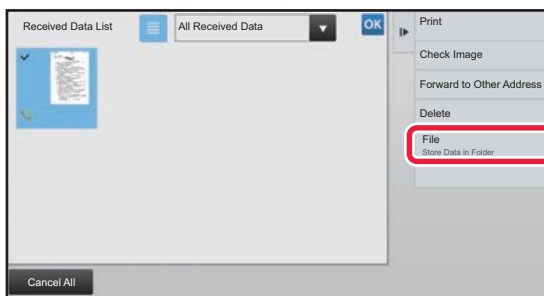

Tap the key of the received data you wish to save, and tap [File] on the action panel.

- Tap  to show a list of received data. The list view or thumbnails view can be changed depending on the setting mode.
- Multiple sets of received data can be selected.



- When you select a single received data only, you can tap [Check Image] on the action panel and check the image on the preview screen.
- To store the sender fax number as a number for "Allow/Reject Number Setting", tap [Register as Junk Fax] on the action panel and, in the confirmation message screen, tap the [Store] key. Specify a sender fax number as a number for "Allow/Reject Number Setting" by selecting, in "Settings (administrator)", select [System Settings] → [Image Send Settings] → [Fax Settings] → [Receive Settings] → [Allow/Reject Number Setting].

3

Set the file information, and tap the [Save] key.



OTHERS FUNCTION

This section explains how to enter a destination from the initial screen of normal mode.

▶ [SELECTING FAX MODE \(page 4-8\)](#)

STORING FAX OPERATIONS (PROGRAM)

This function collectively stores various settings as one program. The stored program can be retrieved using an easy operation.

For example, suppose that the same A4 (8-1/2" x 11") size documents are distributed to branch offices in various regions once a month.

- (1) The same documents are faxed to each branch office
- (2) To save paper, two document pages are faxed as a single page
- (3) Smudges on the edges of the documents are erased before transmission

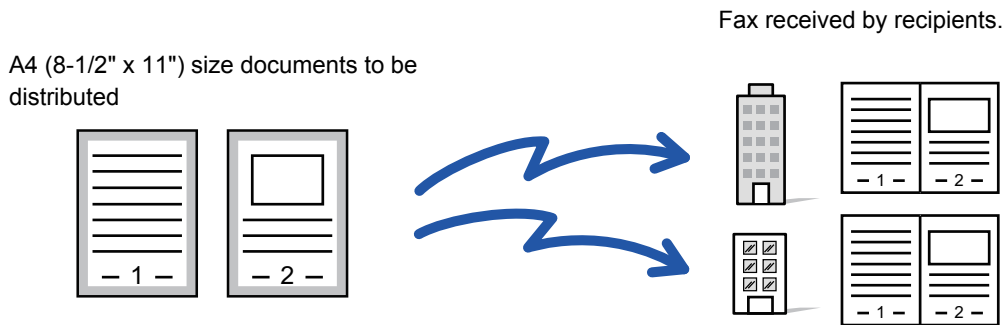

When a job program is not stored	When a job program is stored
<p>Enter the fax number for each branch.</p> <p>↓</p> <p>Specify N-Up.</p> <p>↓</p> <p>Specify Erase.</p> <p>↓</p> <p>Tap the [Start] key.</p> <p>Scan and send the original.</p>	<p>Call the registered program.</p> <p>↓</p> <p>Tap the [Start] key.</p> <p>Scan and send the original.</p>
<p>Considerable time is required to send the documents each month because the above settings must be selected. In addition, mistakes are occasionally made when selecting the settings.</p>	<p>When a program is stored, settings are selected with ease by simply tapping the key of the program. In addition, transmission takes place according to the stored settings so there are no chances for mistakes.</p>



To configure a program:

Tap [Program Registration] that appears on the action panel when you operate any mode screens.



- The settings stored in a program will be retained even after the program is used for transmission. The same settings can be used repeatedly for transmission.
- The following contents cannot be stored in programs:
 - Tapping the [Speaker] key, Quick File, File, page move and unspecified erase during preview, Metadata Entry, Send Settings, and Own Name Select.
- Up to 48 programs can be stored.
- Up to 500 destinations can be stored in one program.
- A program in which sub addresses and passcodes are specified as an F-code destination records all sub addresses and passcodes.

1

Place the original.

According to the function stored in the program, place the original in the document feeder tray of the automatic document feeder, or on the document glass.

- ▶ [AUTOMATIC DOCUMENT FEEDER \(page 1-84\)](#)
- ▶ [DOCUMENT GLASS \(page 1-86\)](#)

2

Tap [Call Program] on the action panel.

3

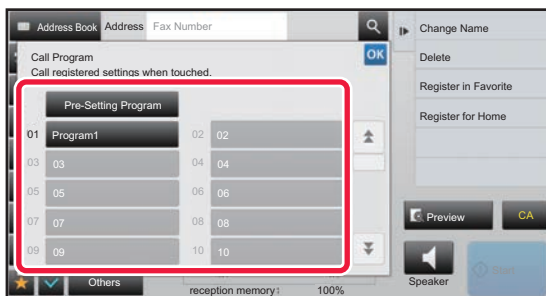

Tap the desired program key.

4

Configure additional settings as required.



Some settings cannot be added depending on the contents of the called program.

5

Tap the [Start] key to start scanning of the original.

If you inserted the original pages in the document feeder tray, all pages are scanned. When you place the original on the document glass, scan each page one at a time. After you have scanned the last original, tap the [Read-End] key. A beep will sound to indicate that scanning and transmission have ended.



You can tap the [Preview] key to check a preview of the image before sending a fax. For more information, see "[CHECKING THE IMAGE TO BE TRANSMITTED \(page 4-30\)](#)".



SENDING ORIGINALS COLLECTIVELY

SENDING TWO PAGES AS A SINGLE PAGE (N-UP)

Reduce two original pages to the equal size and send them as a single page. This function is convenient when you have a large number of original pages and wish to reduce the number of pages sent.

For the standard size (A4 (8-1/2" x 11"), B5, or A5 (5-1/2" x 8-1/2")), original pages are scanned from both the single pass feeder and document glass.

Portrait-oriented originals



Landscape-oriented originals

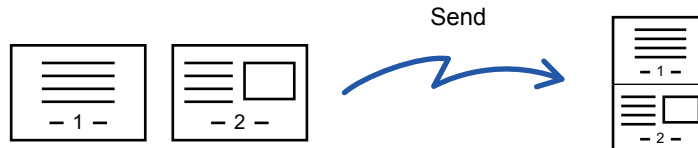

- Transmission is not possible at a size smaller than the original size.
- The N-Up is only available for originals with A4 (8-1/2" x 11"), B5, or A5 (5-1/2" x 8-1/2") size.
- This function cannot be used in direct transmission mode or when the speaker is used to dial.
- When the scan size of the original is specified by numeric values, this function cannot be used.
- This function cannot be used together with Dual Page Scan or Card Shot.

1

Place the original.

Place the original in the document feeder tray of the automatic document feeder, or on the document glass.

- ▶ [AUTOMATIC DOCUMENT FEEDER \(page 1-84\)](#)
- ▶ [DOCUMENT GLASS \(page 1-86\)](#)

2

Enter the destination fax number.

- Entering a destination number using the numeric keys ▶ [page 4-13](#)
- Retrieving a destination from an address book ▶ [page 4-14](#)
- Using a search number to retrieve a destination ▶ [page 4-17](#)
- Retrieving a destination from a global address book ▶ [page 4-18](#)
- Using a transmission log to resend ▶ [page 4-20](#)



3

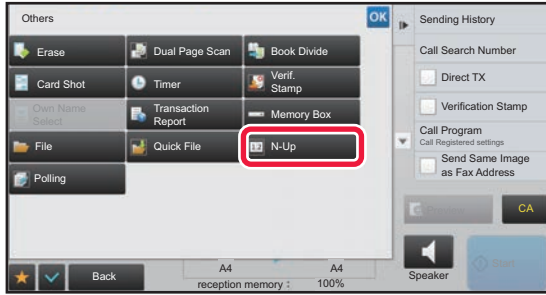

Tap the [Others] key, and tap the [N-Up] key.

A checkmark appears on the icon.

After the settings are completed, tap **OK**.



To cancel the N-Up setting

Tap the [N-Up] key to uncheck it.

4

Tap the [Original] key.

5

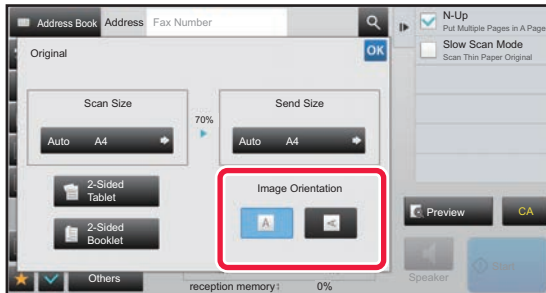

Tap the [Image Orientation] key with the same orientation as the placed original.

If this setting is not correct, a suitable image may not be transmitted.

After the settings are completed, tap **OK**.

6

Tap the [Start] key to start scanning of the original.

- If you inserted the original pages in the document feeder tray, all pages are scanned. A beep will sound to indicate that scanning and transmission have ended.
- When you place the original on the document glass, scan each page one at a time. When scanning finishes, place the next original and tap the [Start] key. Repeat the procedure until all pages have been scanned and then tap the [Read-End] key. A beep will sound to indicate that scanning and transmission have ended.



- You can tap the [Preview] key to check a preview of the image before sending a fax. For more information, see "[CHECKING THE IMAGE TO BE TRANSMITTED \(page 4-30\)](#)".
- If you tap the [Change Setting] key on the scan confirmation screen, you can change the exposure, resolution, scan size, and send size. (However, when scanning each even-numbered page of the original, only the exposure can be changed.)



SENDING BOTH SIDES OF A CARD AS A SINGLE PAGE (CARD SHOT)

Send the front and reverse sides of a card as a single page, without the need to send each side separately.



When using this function, the original must be placed on the document glass.

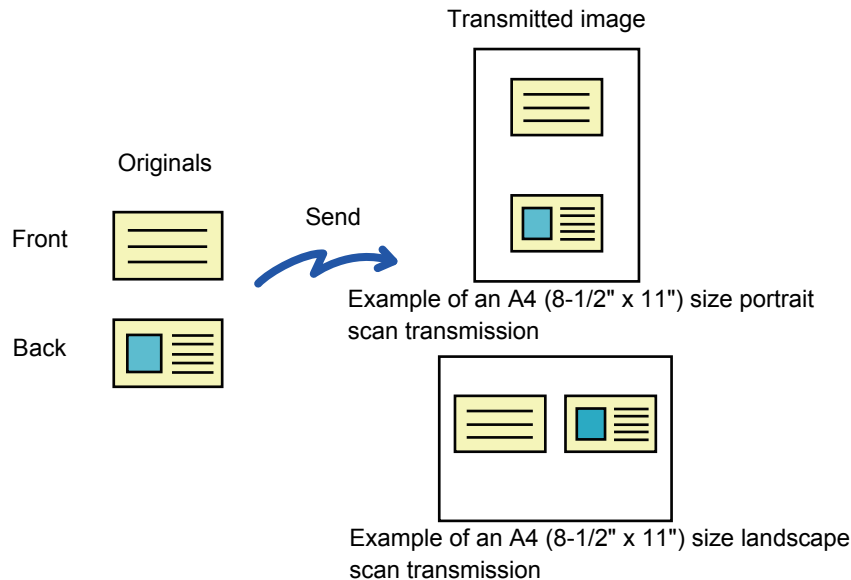

- If the original size is larger than the send size, it will result in a sending failure. Check the original size once more, and specify it again.
- The ratio cannot be specified and "Rotation Sending Setting" cannot be selected.
- This function cannot be used in direct transmission mode or when the speaker is used to dial.

1

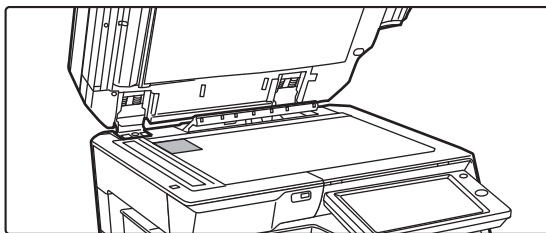

Place a card face down on the document glass.

► [DOCUMENT GLASS \(page 1-86\)](#)

2

Enter the destination fax number.

- Entering a destination number using the numeric keys ► [page 4-13](#)
- Retrieving a destination from an address book ► [page 4-14](#)
- Using a search number to retrieve a destination ► [page 4-17](#)
- Retrieving a destination from a global address book ► [page 4-18](#)
- Using a transmission log to resend ► [page 4-20](#)

3

Tap the [Others] key, and tap the [Card Shot] key.



4

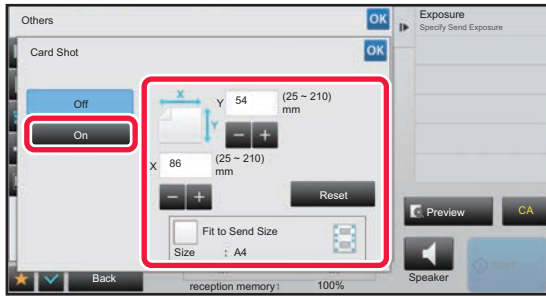

Tap the [On] key, and specify the original size as required.

After the settings are completed, tap **OK** and [Back] keys in sequence.



- Tap the areas displaying width and height sizes respectively, and enter the sizes using the numeric keys.
- To quickly set the size, first specify a value close to the desired ratio value by the numeric keys, then adjust it by tapping **-** **+**.
- To enlarge or reduce the images to fit the paper based on the entered original size, set the [Fit to Send Size] checkbox to .
- After selecting Card Shot, tap the [Original] key in the base screen to change the original scan size or the send size. In this case, the screen of this step appears when you tap the scan size key. For the procedure for setting the send size, see "[SPECIFYING THE SEND SIZE OF THE IMAGE \(page 4-52\)](#)".
- To cancel the specified size settings, tap the [Reset] key.



To cancel the Card Shot settings

Tap the [Off] key.

5

Tap the [Start] key, and scan the front side.

6

Place a card face up on the document glass, and tap the [Start] key to scan the reverse side.



Before scanning the back of the card, tap the [Change Setting] key on the touch panel to change the exposure.

7

Tap the [Read-End] key.



If you will continue by scanning the front of the card, you can tap the [Change Setting] key to change the exposure, resolution, scan size, and send size.



SENDING A LARGE NUMBER OF PAGES (JOB BUILD)

This function lets you separate an original consisting of numerous pages into sets, scan each set using the automatic document feeder, and transmit the pages in a single transmission. You can also send a fax by placing originals in both the automatic document feeder and on the document glass. Use this function when there are more original pages than can be placed at once in the automatic document feeder. When scanning originals that are separated into sets, scan the set that has the first page first. The settings that you select for the first set can be used for all remaining sets.

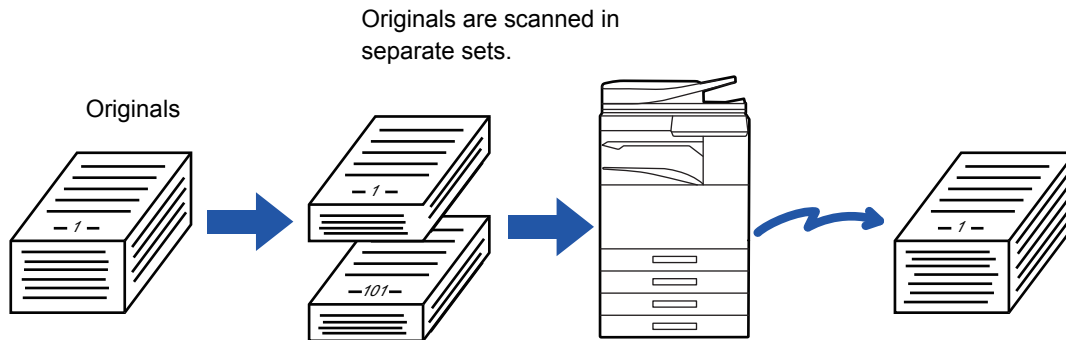

This function is not available for Quick On Line Sending, manual transmission, Direct TX, or transmission using the speaker.

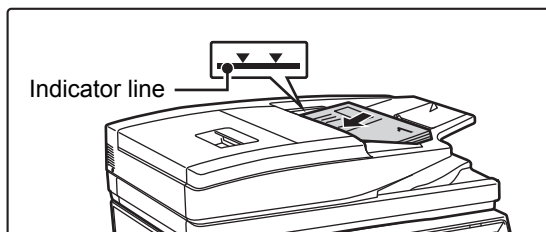

- If you are going to change all original settings, select the settings before scanning the original.
- Up to 999 pages can be scanned. Note that when the memory is being used for other jobs, fewer pages can be scanned.
- If the memory becomes full during scanning, a message will appear and the transmission will be cancelled.
- The scan settings can be changed for each set of originals.

1

Place the original in the document feeder tray of the automatic document feeder.

Insert the originals all the way into the document feeder tray. Originals can be stacked up to the indicator line. Originals can also be placed on the document glass.

► [AUTOMATIC DOCUMENT FEEDER \(page 1-84\)](#)

2

Enter the destination fax number.

- Entering a destination number using the numeric keys ► [page 4-13](#)
- Retrieving a destination from an address book ► [page 4-14](#)
- Using a search number to retrieve a destination ► [page 4-17](#)
- Retrieving a destination from a global address book ► [page 4-18](#)
- Using a transmission log to resend ► [page 4-20](#)



3

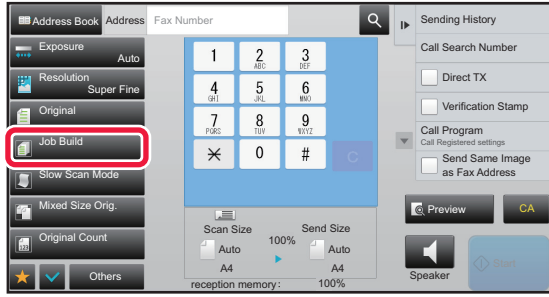

Tap the [Job Build] key.

A checkmark appears on the icon.



To cancel the job build setting
Tap the [Job Build] key to uncheck it.

4

Change settings as needed.

5

Tap the [Start] key to scan the first original page.

6

Place the next set of originals and tap the [Start] key.

Repeat this step until all originals have been scanned.



- If needed, tap [Change Setting] before tapping the [Start] key, and change the original scan settings and send settings for the next original. The setting changes will be applied to the next job.
- If you tap the [Preview] key, you cannot scan additional pages.



To cancel scanning:
Tap the [CA] key. All settings including scanned data will be cleared.

7

Tap the [Read-End] key.



If no action is taken for one minute after the confirmation screen appears, scanning automatically ends and the transmission is reserved.



To change the time until transmission takes place automatically:
Select "Settings (administrator)" - [System Settings] → [Image Send Settings] → [Common Settings] → [Condition Settings] → [Job Auto Start Time During Scanning].



SENDING ORIGINALS OF DIFFERENT SIZES (MIXED SIZE ORIGINAL)

This feature lets you scan and transmit originals of different sizes at the same time; for example, B4 (8-1/2" x 14") size originals mixed together with A3 (11" x 17") size originals.

When scanning the originals, the machine automatically detects the size of each original.



This feature can only be used with the following combinations of original sizes:

- A3 and B4, A3 and B5, B4 and A4, and A4 and B5
- A4R and B5, B4 and A4R, B4 and A5, and B5 and A5
- 11" x 17" and 8-1/2" x 14", 11" x 17" and 8-1/2" x 13"
- 11" x 17" and 5-1/2" x 8-1/2"



- On the MX-2630N/MX-3050V/MX-3060V/MX-3550V/MX-3560V/MX-4050V/MX-4060V/MX-5050V/MX-6050V, duplex scanning is not possible when the above mixed width original scanning is performed.
- When Mixed Size Original is selected, an original scan size cannot be specified.
- After the original scan size has been selected, Mixed Size Original cannot be specified.
- Rotate cannot be used when Mixed Size Original is enabled.



This function is not available if [System Settings] → [Common Settings] → [Device Control] → [Original Size Detector Setting] is set to "AB-3" in "Settings".

1

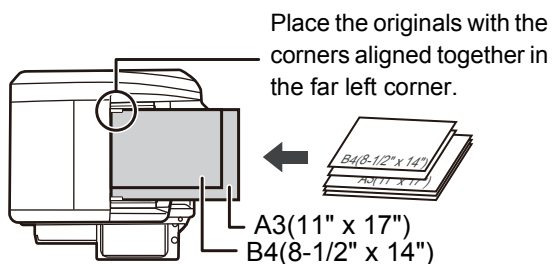

Place originals in the automatic document feeder.

Insert the originals with the corners aligned together in the far left corner of the document feeder tray.

► [AUTOMATIC DOCUMENT FEEDER \(page 1-84\)](#)

2

Enter the destination fax number.

- Entering a destination number using the numeric keys ► [page 4-13](#)
- Retrieving a destination from an address book ► [page 4-14](#)
- Using a search number to retrieve a destination ► [page 4-17](#)
- Retrieving a destination from a global address book ► [page 4-18](#)
- Using a transmission log to resend ► [page 4-20](#)



3

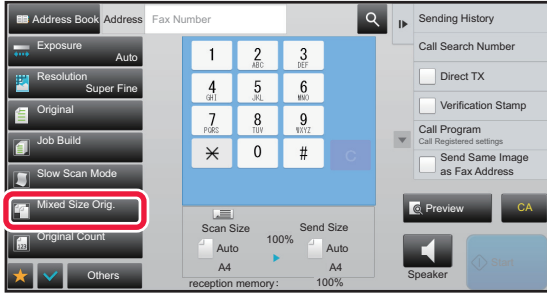

Tap the [Mixed Size Orig.] key.

A checkmark appears on the icon.



For mixed size originals, set "Original" to "Auto".



To cancel the mixed size original setting

Tap the [Mixed Size Orig.] key to uncheck it.

4

Tap the [Start] key to start scanning of the original.



Tap the [Preview] key to check the preview of an image before sending a fax.

For more information, see "[CHECKING THE IMAGE TO BE TRANSMITTED \(page 4-30\)](#)". However, settings for this function cannot be changed in the preview screen.



SENDING AN ORIGINAL AS SEPARATE PAGES

SENDING AN ORIGINAL AS TWO SEPARATE PAGES (DUAL PAGE SCAN)

The left and right sides of an original can be transmitted as two separate pages. This function is useful when you wish to fax the left and right pages of a book or other bound document as separate pages.

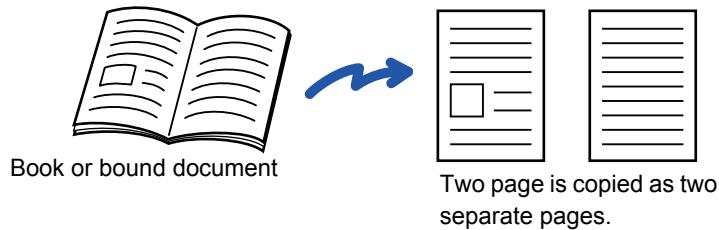

Original scan size	Transmitted image
A3 (11" x 17") x 1 page	A4 (8-1/2" x 11") x 2 pages



When using dual page scan, the original must be placed on the document glass.



- This function can be enabled when the original size setting is set to [Auto].
- Note that "Centre Erase" and "Edge+Centre Erase" cannot be used.

1

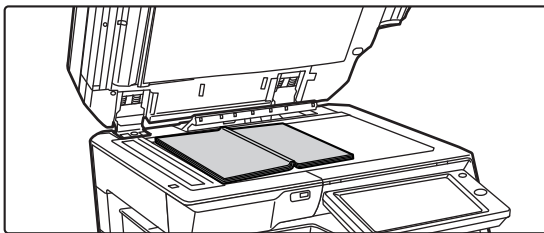

Place the original on the document glass.

► [DOCUMENT GLASS \(page 1-86\)](#)

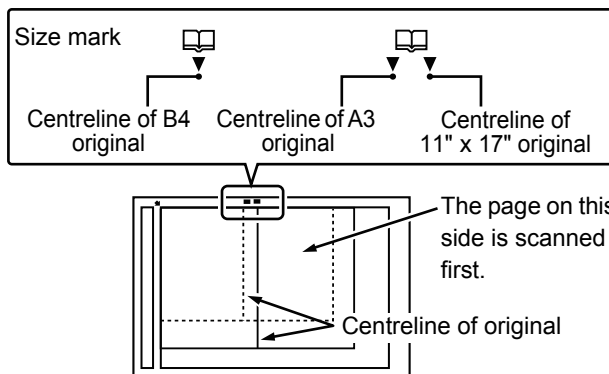

Align the centre of the original with the appropriate size mark



2

Enter the destination fax number.

- Entering a destination number using the numeric keys [▶ page 4-13](#)
- Retrieving a destination from an address book [▶ page 4-14](#)
- Using a search number to retrieve a destination [▶ page 4-17](#)
- Retrieving a destination from a global address book [▶ page 4-18](#)
- Using a transmission log to resend [▶ page 4-20](#)

3

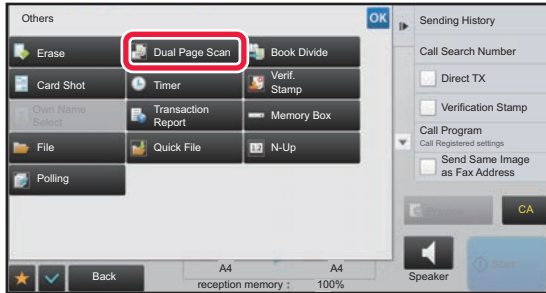
**Tap the [Others] key, and tap the [Dual Page Scan] key.**

A checkmark appears on the icon.
After the settings are completed, tap the [Back] key.

**To cancel the Dual Page Scan setting:**

Tap the [Dual Page Scan] key to clear the checkmark.

4

Tap the [Start] key to start scanning of the original.



SPLITTING A PAMPHLET BY PAGE AND TRANSMITTING THE PAGES SUCCESSIVELY (BOOK DIVIDE)

The opened pages of a saddle-stitch pamphlet are split by page according to actual page order. When using this function, you do not need to sort the original pages to be sent.

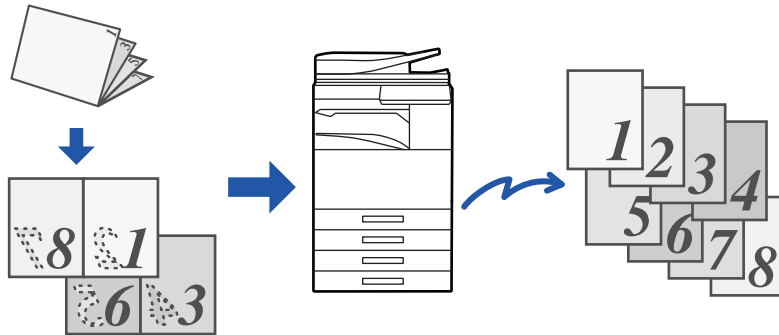

This function can be enabled when the original size setting is set to [Auto].



The document glass is not available for this function.

1

Place the original in the document feeder tray of the automatic document feeder.

► [AUTOMATIC DOCUMENT FEEDER \(page 1-84\)](#)

2

Enter the destination fax number.

- Entering a destination number using the numeric keys ► [page 4-13](#)
- Retrieving a destination from an address book ► [page 4-14](#)
- Using a search number to retrieve a destination ► [page 4-17](#)
- Retrieving a destination from a global address book ► [page 4-18](#)
- Using a transmission log to resend ► [page 4-20](#)

3

Tap the [Others] key, and tap the [Book Divide] key.



4

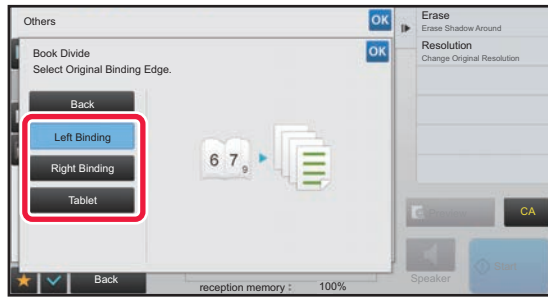

Select the binding edge of the pamphlet original.

Check the preview image displayed in the screen, and make sure that the binding edge is correct.

After the settings are completed, tap **OK** and [Back] keys in sequence.



To cancel the Book Divide setting:

Tap the [Off] key.

5

Tap the [Start] key to start scanning of the original.

A beep will sound to indicate that scanning and transmission have ended.



Tap the [Preview] key to check the preview of an image before sending a fax.

For more information, see "[CHECKING THE IMAGE TO BE TRANSMITTED \(page 4-30\)](#)". However, settings for this function cannot be changed in the preview screen.



SCANNING ORIGINALS

ERASING PERIPHERAL SHADOWS ON THE IMAGE (ERASE)

This function erases the parts of the image where shadows tend to form, but does not detect shadows and erase only the shadows.

Scanning a thick book

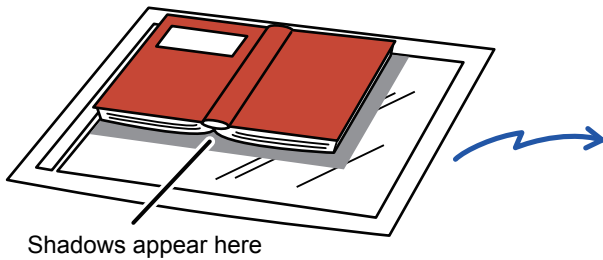

Not using the erase function	Using the erase function
Shadows appear in the image.	No shadows appear.

Erase modes

Edge Erase

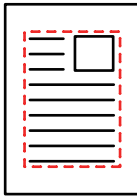

Centre Erase

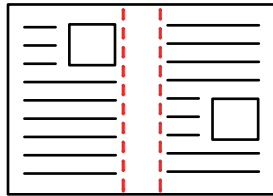

Edge + Centre Erase

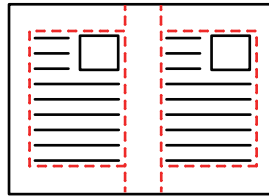

Side Erase



If a ratio setting is used in combination with an erase setting, the erase width will change according to the selected ratio. This function erases the parts of the image where shadows tend to form, but does not detect shadows and erase only the shadows.

For example, if you set an erase width of 10 mm (1/2") and reduce the image to 70% before transmission, the erase width will be reduced to 7 mm (3/8").



To change the default erase width setting:

Select [System Settings] → [Image Send Settings] → [Common Settings] → [Condition Settings] → [Erase Width Adjustment].

The width can be set from 0 mm to 20 mm (0" to 1"). The factory default setting is 10 mm (1/2"). The setting changed here will apply to [System Settings] → [Copy Settings] → [Condition Settings] → [Erase Width Adjustment] in "Settings".

1

Place the original.

Place the original in the document feeder tray of the automatic document feeder, or on the document glass.

- ▶ [AUTOMATIC DOCUMENT FEEDER \(page 1-84\)](#)
- ▶ [DOCUMENT GLASS \(page 1-86\)](#)



2

Enter the destination fax number.

- Entering a destination number using the numeric keys ► [page 4-13](#)
- Retrieving a destination from an address book ► [page 4-14](#)
- Using a search number to retrieve a destination ► [page 4-17](#)
- Retrieving a destination from a global address book ► [page 4-18](#)
- Using a transmission log to resend ► [page 4-20](#)

3

Tap the [Others] key, and tap the [Erase] key.

4

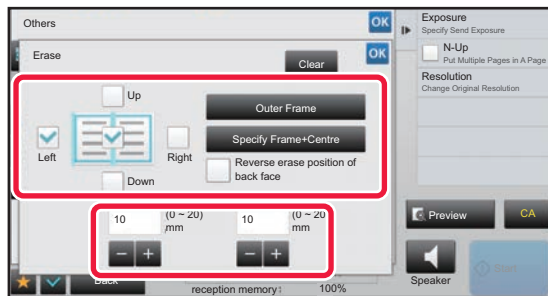
**Tap the checkbox of the edge that you wish to erase, and specify the erase position.**

Check that the tapped checkbox is set to . If the [Specify Frame] key is tapped, the [Up], [Down], [Left], and [Right] checkboxes are set to . If the [Specify Frame+Centre] key is tapped, all the checkboxes are set to .



Specify the erase edge on the reverse side when erasing edges of one to three sides of Up, Down, Left, and Right on the front side to scan a 2-sided original.

- If the [Reverse erase position of back face] checkbox is set to , the edge in the position opposite to the erased edge on the front side will be erased.
- If the [Reverse erase position of back face] checkbox is set to , the edge in the same position as on the front side will be erased.

5

Specify the erase width.

After the settings are completed, tap **OK** and [Back] keys in sequence.



- Tap the numeric value display indicating the margin shift area on the front side or reverse side, and enter the area using the numeric keys.
- To quickly set the area, first specify a value close to the desired value by the numeric keys, then adjust it with **-** **+**.

**To cancel the erase setting:**

Tap the [Clear] key.



6**Tap the [Start] key to start scanning of the original.**

- A beep will sound to indicate that scanning and transmission have ended.
 - When you place the original on the document glass, scan each page one at a time. When scanning finishes, place the next original and tap the [Start] key.
 - Repeat the procedure until all pages have been scanned and then tap the [Read-End] key.
-



You can tap the [Preview] key to check a preview of the image before sending a fax. For more information, see "[CHECKING THE IMAGE TO BE TRANSMITTED \(page 4-30\)](#)". However, settings for this function cannot be changed in the preview screen.



SENDING A THIN ORIGINAL (SLOW SCAN MODE)

Use this function when you wish to scan thin originals using the automatic document feeder. This function helps prevent thin originals from misfeeding.

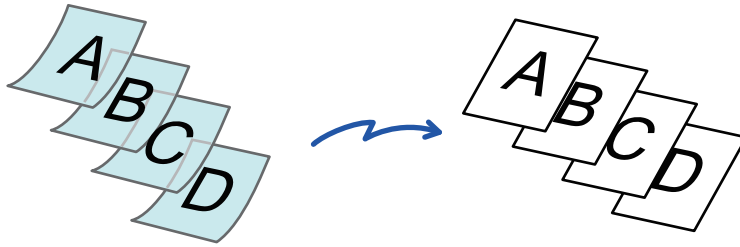

When slow scan mode is selected, 2-sided scanning is not possible.

1

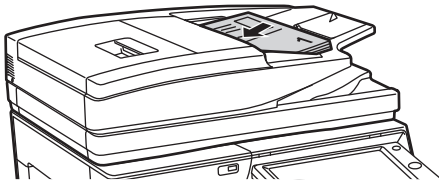

Place the original in the document feeder tray of the automatic document feeder.

► [AUTOMATIC DOCUMENT FEEDER \(page 1-84\)](#)
Adjust the original guides slowly.



If the originals are inserted with too much force, they may crumple and misfeed.

2

Enter the destination fax number.

- Entering a destination number using the numeric keys ► [page 4-13](#)
- Retrieving a destination from an address book ► [page 4-14](#)
- Using a search number to retrieve a destination ► [page 4-17](#)
- Retrieving a destination from a global address book ► [page 4-18](#)
- Using a transmission log to resend ► [page 4-20](#)



3

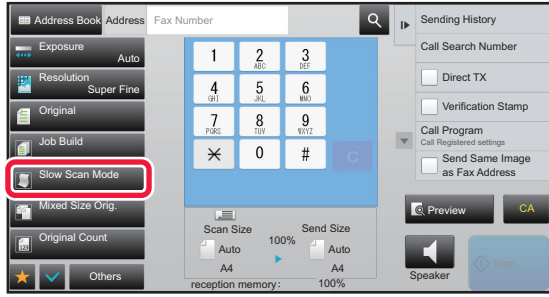

Tap the [Slow Scan Mode] key.

A checkmark appears on the icon.



To cancel the slow scan mode setting

Tap the [Slow Scan Mode] key to uncheck it.

4

Tap the [Start] key to start scanning of the original.

A beep will sound to indicate that scanning and transmission have ended.



Tap the [Preview] key to check the preview of an image before sending a fax. For more information, see "[CHECKING THE IMAGE TO BE TRANSMITTED \(page 4-30\)](#)". However, settings for this function cannot be changed in the preview screen.



CHECKING THE NUMBER OF SCANNED ORIGINAL SHEETS BEFORE TRANSMISSION (ORIGINAL COUNT)

Count the number of scanned original sheets and display the count before transmission.

Checking the number of scanned original sheets before transmission helps prevent transmission mistakes.



The count result is displayed with the number of scanned original sheets, not the number of scanned original pages. For example, when a 2-sided original is transmitted, the number "1" will appear to indicate that one original sheet is transmitted, not "2" to indicate the front-side page and the reverse side page.

1

Place originals in the automatic document feeder.

► [AUTOMATIC DOCUMENT FEEDER \(page 1-84\)](#)

2

Enter the destination fax number.

- Entering a destination number using the numeric keys ► [page 4-13](#)
- Retrieving a destination from an address book ► [page 4-14](#)
- Using a search number to retrieve a destination ► [page 4-17](#)
- Retrieving a destination from a global address book ► [page 4-18](#)
- Using a transmission log to resend ► [page 4-20](#)

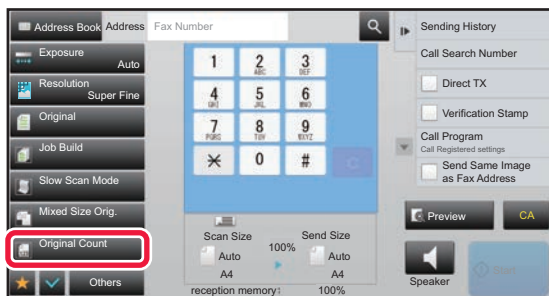
3

Tap the [Original Count] key.

A checkmark appears on the icon.



To cancel the original count setting:

Tap the [Original Count] key to uncheck it.

4

Tap the [Start] key to start scanning of the original.



Tap the [Preview] key to check the preview of an image before sending a fax. For more information, see "[CHECKING THE IMAGE TO BE TRANSMITTED \(page 4-30\)](#)". However, settings for this function cannot be changed in the preview screen.



5

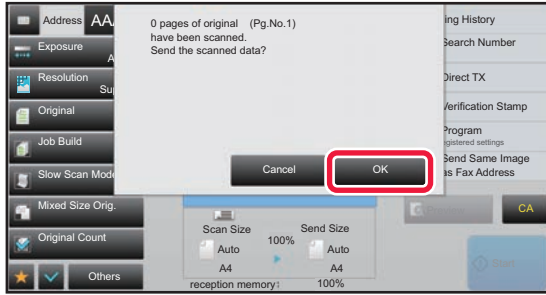

When scanning is completed, check the number of original sheets.

The number that is displayed is the number of scanned original sheets, not the number of scanned original pages. For example, when 2-sided copying is performed using one original, the number "1" will appear to indicate that one original sheet was scanned, not "2" to indicate the front-side page and the reverse side page.

6

Tap the [OK] key to start transmission.



If this function is combined with [Job Build], the count result is displayed after the [Read-End] key has been tapped.



If the displayed number of original sheets is different from the actual number of sheets:

Tap the [Cancel] key and then tap the [OK] key in the message screen to clear all scanned data. Scan settings and destination settings will not be cleared. Insert the original sheets in the document feeder tray again and tap the [Start] key to re-scan.



STAMPING SCANNED ORIGINALS (VERIFICATION STAMP)

This function stamps each original that is scanned using the automatic document feeder, allowing you to verify that all originals were correctly scanned.

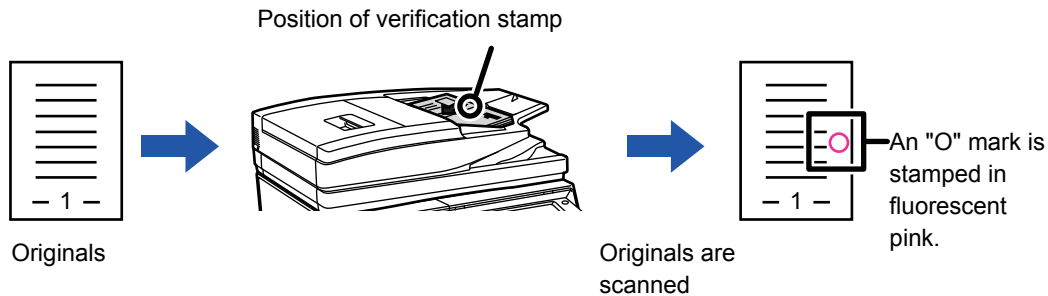

- To use the verification stamp function, the optional stamp unit must be installed.
- When 2-sided originals are used, the front of each original is stamped twice.
- If an error occurs during scanning, an original that was not scanned may be stamped.
- When the "O" mark that is stamped on originals starts to become faint, replace the stamp cartridge.
For the procedure for replacing the stamp cartridge, see "[REPLACING THE STAMP CARTRIDGE \(page 1-162\)](#)".

1

Place originals in the automatic document feeder.

- [AUTOMATIC DOCUMENT FEEDER \(page 1-84\)](#)

2

Enter the destination fax number.

- Entering a destination number using the numeric keys ► [page 4-13](#)
- Retrieving a destination from an address book ► [page 4-14](#)
- Using a search number to retrieve a destination ► [page 4-17](#)
- Retrieving a destination from a global address book ► [page 4-18](#)
- Using a transmission log to resend ► [page 4-20](#)

3

Tap [Verification Stamp] on the action panel or [Others] key, and tap the [Verif. Stamp] key.

The appropriate icon or checkbox is selected.

If you tap the [Others] key, tap the [Back] key after the settings have been completed.



To cancel the verification stamp setting:

Tap [Verification Stamp] on the action panel or the [Others] key, and tap [Verif. Stamp] to clear the checkmark.

4

Tap the [Start] key to start scanning of the original.

A beep will sound to indicate that scanning and transmission have ended.



When you use the automatic document feeder to scan an original, you can tap the [Preview] key to check a preview of the image before sending a fax. For more information, see "[CHECKING THE IMAGE TO BE TRANSMITTED \(page 4-30\)](#)". However, settings for this function cannot be changed in the preview screen.



OPERATING FAX TRANSMISSION AND RECEPTION REMOTELY

CALLING A FAX MACHINE AND INITIATING RECEPTION (POLLING)

When you connect to another machine and receive a document from it, this is called "Polling".

The document reception from another machine is called "Polling Reception".

You can enter multiple destination numbers. When you enter multiple destination numbers, the document is received by polling in the sequence you have entered the destination numbers.

Document reception by polling from multiple machines is called "Serial Polling".

Use the manual polling reception when you must start polling after listening to a recorded greeting, such as when using a fax information service.

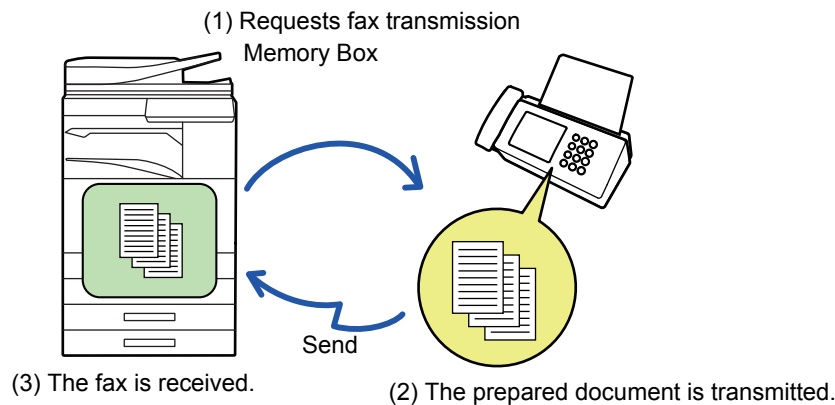

- Make sure there is no original in the machine when using the polling reception function.
- The function can only be used when the other machine is Super G3 or G3 compatible and has a polling function.
- The receiving machine bears the expense (phone charges) of the polling reception.
- If necessary, this function can be combined with the timer transmission to perform the polling reception at any time such as at night or when you are not present. (Only one timer polling reception can be set.)



1

Enter the destination fax number.

- Entering a destination number using the numeric keys ► [page 4-13](#)
- Retrieving a destination from an address book ► [page 4-14](#)
- Using a search number to retrieve a destination ► [page 4-17](#)
- Retrieving a destination from a global address book ► [page 4-18](#)
- Using a transmission log to resend ► [page 4-20](#)



- Multiple fax numbers can be entered (maximum of 500).
- Polling will take place in the order that the multiple fax numbers were entered. Document reception by polling from multiple machines is called "Serial Polling".
- To enter multiple fax numbers, tap **+** after entering a fax number and enter the next fax number.



- In this procedure, one-touch keys that have a sub-address and passcode cannot be used.
- A one-touch key in which an address other than fax number is stored cannot be used.

2

Tap the [Others] key, and tap the [Polling] key.

A checkmark appears on the icon.
After the settings are completed, tap the [Back] key.



To cancel the Polling setting:
Tap the [Polling] key to clear the checkmark.

3

Tap the [Start] key to initiate fax reception.

Your machine will call the other machine and initiate reception of the fax.



INITIATING POLLING RECEPTION MANUALLY

Use the manual polling reception when you must start polling after listening to a recorded greeting, such as when using a fax information service.



- Make sure there is no original in the machine when using the polling reception function.
- This function cannot be used to poll multiple machines (serial polling).
- The function can only be used when the other machine is Super G3 or G3 compatible and has a polling function.



The receiving machine bears the expense (phone charges) of the polling reception.

1

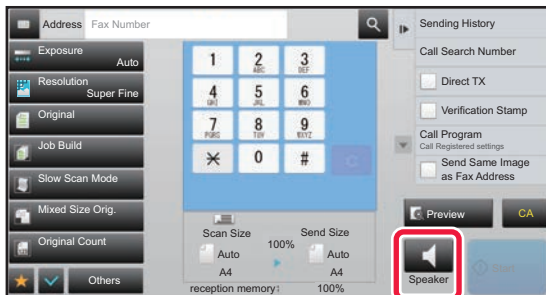

Tap the [Speaker] key.

You will hear the dial tone through the machine's speaker.

2

Enter the destination fax number.

- Entering a destination number using the numeric keys [▶ page 4-13](#)
- Retrieving a destination from an address book [▶ page 4-14](#)
- Using a search number to retrieve a destination [▶ page 4-17](#)
- Retrieving a destination from a global address book [▶ page 4-18](#)
- Using a transmission log to resend [▶ page 4-20](#)



One-touch key for a contact or group in which multiple destinations are stored, and one-touch key for which an address other than fax number is stored cannot be used.



After tapping the [Speaker] key, you can tap the [Speaker Volume] key to adjust the volume of the speaker.

3

Tap the [Others] key, and tap the [Polling] key to receive originals (data).

A checkmark appears on the icon.



To cancel the Polling setting:

Tap the [Polling] key to clear the checkmark.



SENDER-RELATED FEATURES

ADDING YOUR SENDER INFORMATION TO FAXES (FAX OWN NUMBER SENDING)

Your sender information (date, time, sender name, sender fax number or destination name, number of pages) is automatically added to the top of each fax page you transmit.

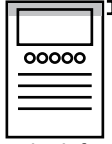
Outside scanned image (factory default setting)	Load
 <p>The transmitted image length will be length of sender information + length of original image. When the fax is printed by the receiving machine, it may be reduced or divided onto two pages.</p>	 <p>The sender information is printed inside the original image, and thus the transmitted image length is the length of the original. Note that the sender information will overlap part of the original image (the overlapped part of the original image will not appear).</p>

Example of the sender information printed

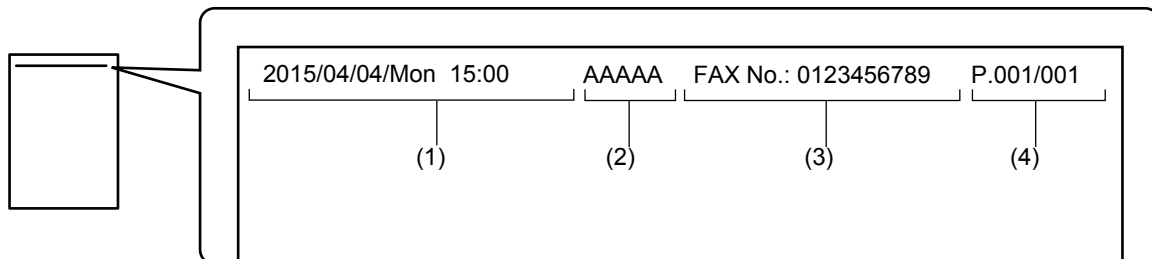

- (1) Date, time: The date and time of transmission.
- (2) Sender name: The sender name programmed in the machine.
- (3) Sender fax number or destination name (one-touch key name)
- (4) Page numbers: Page number/total pages



If destination name is set to be attached and the destination is not specified using a one-touch key, this information is not added to the fax and not printed.



- **To set the date and time:**
In "Settings", select [System Settings] → [Common Settings] → [Clock Adjust].
- **To store a sender name and sender fax number:**
In "Settings (administrator)", select [System Settings] → [Image Send Settings] → [Common Settings] → [Own Name and Destination Set] → [Own Number and Name Set] → [Sender Data Registration].
• When you use the Own Number Setting, always configure this information.
- **To add the number of pages to be transmitted:**
In "Settings", select [System Settings] → [Image Send Settings] → [Fax Settings] → [Send Settings] → [Printing Page Number at Receiver].
Page numbers appear in the format "page number/total pages". Only the page number is printed when "Manual Transmission" or "Quick On Line Sending" is used.
- **To select a sender fax number or destination:**
In "Settings", select [System Settings] → [Image Send Settings] → [Fax Settings] → [Send Settings] → [Sender Destination Name Switch].



TEMPORARILY CHANGING THE SENDER INFORMATION (OWN NAME SELECT)

You can temporarily change sender information to be used in the own number sending by selecting from data stored separately.



The function is released when the transmission with the changed sender information ends.



To store the sender information to be used for Own Name Select function:

In "Settings (administrator)", select [System Settings] → [Image Send Settings] → [Common Settings] → [Own Name and Destination Set] → [Own Number and Name Set] → [Sender Data Registration].

1

Place the original.

Place the original in the document feeder tray of the automatic document feeder, or on the document glass.

- ▶ [AUTOMATIC DOCUMENT FEEDER \(page 1-84\)](#)
- ▶ [DOCUMENT GLASS \(page 1-86\)](#)

2

Enter the destination fax number.

- Entering a destination number using the numeric keys ▶ [page 4-13](#)
- Retrieving a destination from an address book ▶ [page 4-14](#)
- Using a search number to retrieve a destination ▶ [page 4-17](#)
- Retrieving a destination from a global address book ▶ [page 4-18](#)
- Using a transmission log to resend ▶ [page 4-20](#)

3

Tap the [Others] key, and tap the [Own Name Select] key.

4

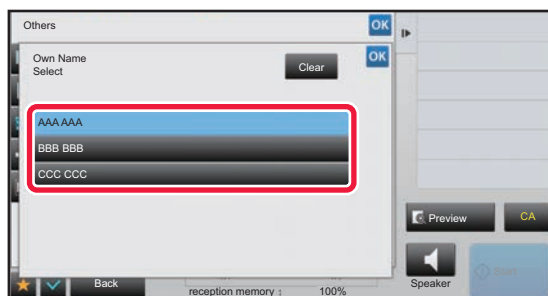

Tap the sender information key to specify the sender information.

After the settings are completed, tap **OK** and [Back] keys in sequence.



To cancel the sender information setting:

Tap the [Clear] key.



5

Tap the [Start] key to start scanning of the original.

- If you inserted the original pages in the document feeder tray, all pages are scanned.
- A beep will sound to indicate that scanning and transmission have ended.
- When you place the original on the document glass, scan each page one at a time.
- When scanning finishes, place the next original and tap the [Start] key. Repeat until all pages have been scanned and then tap the [Read-End] key.

A beep will sound to indicate that transmission has ended.



You can tap the [Preview] key to check a preview of the image before sending a fax. For more information, see "[CHECKING THE IMAGE TO BE TRANSMITTED \(page 4-30\)](#)". However, settings for this function cannot be changed in the preview screen.



ASSUMING A SPECIFIC USAGE

SPECIFYING THE TIME FOR COMMUNICATION

Specify a time at which a transmission or broadcast transmission will automatically take place. Transmission begins automatically at the specified time.

This function is helpful when you wish to perform reserved, broadcast or other transmissions during your absence or at night or other times when telephone rates are low. A timer setting can also be specified for polling reception to receive a fax when you are not present.

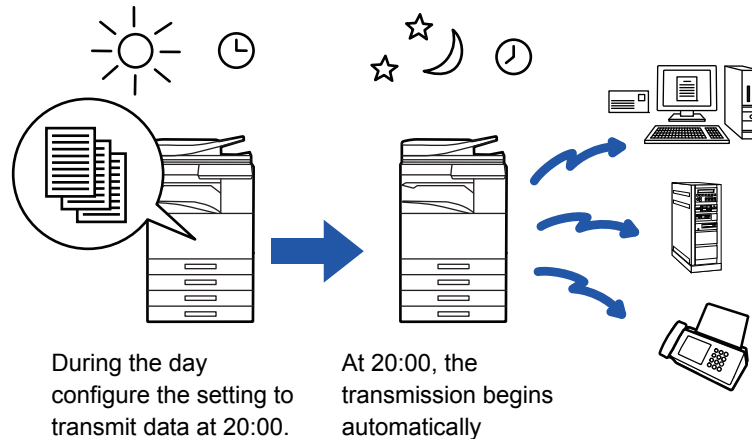

- When a timer transmission is set, keep the main power switch " | ". Transmission will not take place if the status is " ⏻ " at the specified time.
- When performing a timer transmission, you must scan the original into memory when you set up the transmission. It is not possible to leave the document in the document feeder tray or on the document glass and have it scanned at the reserved time of transmission.
- Up to 100 timer transmissions can be stored at once.
- This function cannot be used in direct transmission mode or when the speaker is used to dial.



- If another transmission is in progress when the specified time arrives, the timer operation will begin after that transmission is finished.
- Only one timer polling operation can be stored at once. To receive data from multiple destinations by polling, specify Timer for serial polling.
- Settings selected for a timer transmission (exposure, resolution, other functions, etc.) are automatically cleared after the transmission is finished. (However, when the document filing function is used, the scanned original and settings are stored in the built-in hard drive.)
- If a job scheduled for timer transmission is given priority on the job status screen, the timer will be cancelled. The transmission will begin as soon as the job in progress is completed.
 - ▶ [PRIORITY PROCESSING OF A RESERVED JOB \(page 1-91\)](#)
- The time can be specified up to a week in advance.
- Other operations can be performed after a timer transmission is set up.
- A timer transmission can be deleted in the job status screen.

1

Place the original.

Place the original in the document feeder tray of the automatic document feeder, or on the document glass.

- ▶ [AUTOMATIC DOCUMENT FEEDER \(page 1-84\)](#)
- ▶ [DOCUMENT GLASS \(page 1-86\)](#)



2

Enter the destination fax number.

- Entering a destination number using the numeric keys ► [page 4-13](#)
- Retrieving a destination from an address book ► [page 4-14](#)
- Using a search number to retrieve a destination ► [page 4-17](#)
- Retrieving a destination from a global address book ► [page 4-18](#)
- Using a transmission log to resend ► [page 4-20](#)

3

Tap the [Others] key, and tap the [Timer] key.

4

Tap the [On] key.

5

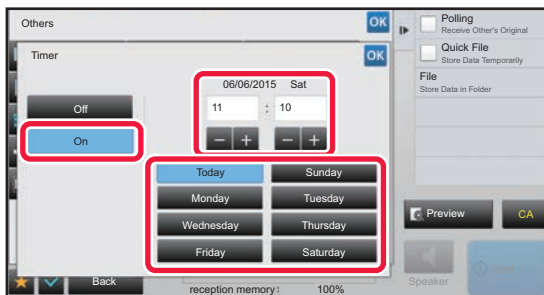
**Specify the date.**

6

Specify the time (hour and minute) in 24-hour format.

After the settings are completed, tap **OK** and [Back] keys in sequence.



- Tap the areas displaying the hour and minute respectively, and enter the values using the numeric keys.
- It is convenient to use **- +** to finely adjust the time.
- The setting will show the current time. If the time is not correct, press the [CA] key to cancel the operation. Correct the time in setting mode and then perform the timer transmission procedure.
 - [BEFORE USING THE MACHINE AS A FAX \(page 4-4\)](#)

**To cancel the Timer Transmission settings:**

Tap the [Off] key.

**To set the date and time of the machine:**

In "Settings", select [System Settings] → [Common Settings] → [Clock Adjust].

If [Disabling of Clock Adjustment] has been enabled, the date and time cannot be modified. In this case, select [System Settings] in "Settings (administrator)" and select [Common Settings] → [Enable/Disable Settings] to disable the [Disabling of Clock Adjustment] setting.



7

Tap the [Start] key to start scanning of the original.

- If you inserted the original pages in the document feeder tray, all pages are scanned. A beep will sound to indicate that scanning has ended, and the machine stands by for transmission.
- When you place the original on the document glass, scan each page one at a time. When scanning finishes, place the next original and tap the [Start] key. Repeat until all pages have been scanned and then tap the [Read-End] key. A beep will sound to indicate that scanning has ended, and the machine stands by for transmission.



You can tap the [Preview] key to check a preview of the image before sending a fax. For more information, see "[CHECKING THE IMAGE TO BE TRANSMITTED \(page 4-30\)](#)". However, settings for this function cannot be changed in the preview screen.



The original is scanned into memory. The original cannot be scanned at a specified time.

CHANGING THE PRINT SETTINGS FOR THE TRANSACTION REPORT (TRANSACTION REPORT)

A transaction report is automatically printed out to alert you when a transmission fails or when a broadcast transmission is performed.

The transaction report contains a description of the transmission (date, start time, name of destination, time required, number of pages, result, etc.).

► [INFORMATION APPEARING IN THE RESULT COLUMN \(page 4-125\)](#)



- Transaction reports are printed based on conditions set in "Settings"; however, you can temporarily select different conditions for a transmission.
- For a broadcast transmission, changes to the transaction report print conditions apply to all destinations.

**To set the printing conditions of transaction report:**

In "Settings (administrator)", select [System Settings] → [Image Send Settings] → [Fax Settings] → [Default Settings] → [Transaction Report Print Select Setting].

1

Place the original.

Place the original in the document feeder tray of the automatic document feeder, or on the document glass.

- [AUTOMATIC DOCUMENT FEEDER \(page 1-84\)](#)
- [DOCUMENT GLASS \(page 1-86\)](#)

2

Enter the destination fax number.

- Entering a destination number using the numeric keys ► [page 4-13](#)
- Retrieving a destination from an address book ► [page 4-14](#)
- Using a search number to retrieve a destination ► [page 4-17](#)
- Retrieving a destination from a global address book ► [page 4-18](#)
- Using a transmission log to resend ► [page 4-20](#)



3

Tap the [Others] key, and tap the [Transaction Report] key.

4

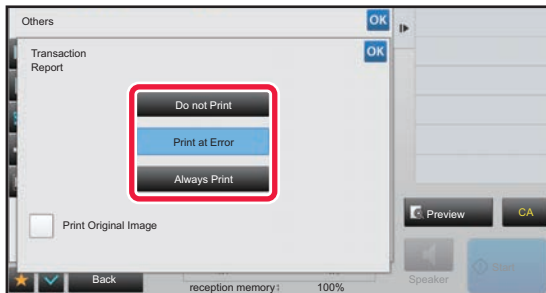

Tap the key of the print settings.

After the settings are completed, tap **OK** and [Back] keys in sequence.



To cancel the transaction report setting:

Tap the [Do not Print] key.



- The print conditions for a transaction report are as follows:
 - "Always Print": A transaction report is printed no matter whether the transmission succeeds or fails.
 - "Print at Error": A transaction report is printed when transmission fails.
 - "Do not Print": Do not print a transaction report.
- Set the [Print Original Image] checkbox to to include the first page of the transmitted original in the transaction report.
- Even if the [Print Original Image] checkbox is , the original cannot be printed when speaker dialling, manual transmission, direct transmission, polling reception, or F-code transmission is used.

5

Tap the [Start] key to start scanning of the original.

- If you inserted the original pages in the document feeder tray, all pages are scanned.
- A beep will sound to indicate that scanning and transmission have ended.
- When you place the original on the document glass, scan each page one at a time.
- When scanning finishes, place the next original and tap the [Start] key. Repeat until all pages have been scanned and then tap the [Read-End] key.
A beep will sound to indicate that transmission has ended.



You can tap the [Preview] key to check a preview of the image before sending a fax. For more information, see "[CHECKING THE IMAGE TO BE TRANSMITTED \(page 4-30\)](#)". However, settings for this function cannot be changed in the preview screen.

Original image in transaction report

When [Print Original Image] is enabled, the first page of the transmitted original is printed on the same sheet as the transaction report. The original image is reduced to allow it to fit on the sheet. If the vertical scanning length (X direction) of the original is longer than 432 mm (17-1/64"), the part that exceeds 432 mm (17-1/64") may be cut off.



POLLING MEMORY FUNCTIONS

SENDING A FAX WHEN ANOTHER MACHINE POLLS YOUR MACHINE (POLLING MEMORY)

Sending a document that has been scanned into memory when another machine polls your machine is called "Polling Memory". Prior to polling, the document that will be faxed to the other machine must be scanned into a polling memory box.

► [SCANNING A DOCUMENT INTO POLLING MEMORY \(page 4-105\)](#)

This function can only be used when the other machine is Super G3 or G3 compatible and has a polling function.

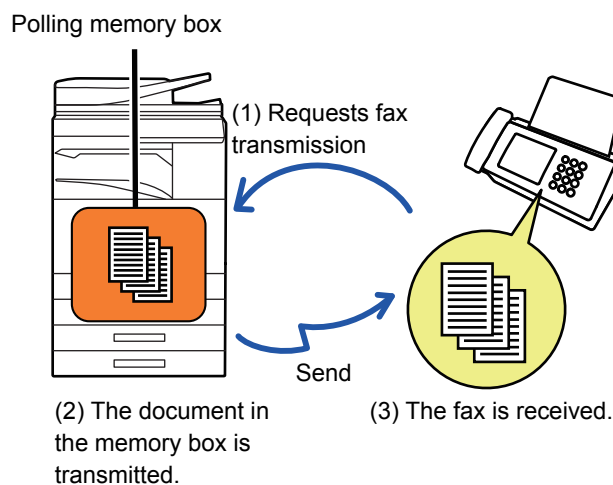

RESTRICTING POLLING ACCESS (POLLING SECURITY SETTING)

The following explains "Polling Security Setting", a feature restricting other machines that can use polling memory. When a machine requests fax transmission, you can only allow the machine to use polling memory if its programmed sender fax number matches a fax number stored in your machine as a polling passcode number. This function is called "Polling Security Setting".

To use this function, first store polling passcode numbers (the sender fax numbers programmed in the other machines) in settings mode of the machine, and then enable the polling security setting.



The polling security setting can be enabled for up to 10 other machines.



To set the polling security:

In "Settings (administrator)", select [System Settings] → [Image Send Settings] → [Fax Settings] → [Polling Setting] → [Set Fax Polling Security].



SCANNING A DOCUMENT INTO POLLING MEMORY

Follow these steps to scan a document into the memory box for polling transmission (Public Box).



If another document remains in the memory box (Public Box), the newly scanned document is added to the previous document. In this case, the number of polling times will be the number set for the newly scanned document.

1

Place the original.

Place the original in the document feeder tray of the automatic document feeder, or on the document glass.

- ▶ [AUTOMATIC DOCUMENT FEEDER \(page 1-84\)](#)
- ▶ [DOCUMENT GLASS \(page 1-86\)](#)

2

Select settings for the original to be scanned and other functions.



You cannot set the Program, Timer, Transaction Report, Polling, and Document Filing.

3

Tap the [Others] key, and tap the [Memory Box] key.

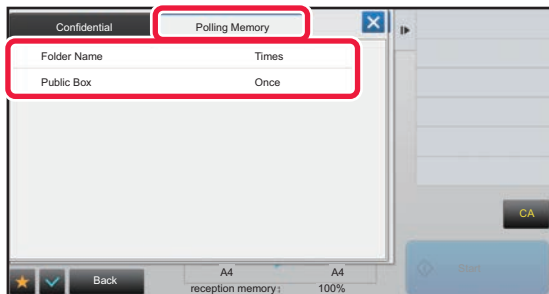
4

Tap the [Polling Memory] tab.

5

Tap the [Public Box] key from the folder list.

6

Tap [Change Number of Times] on the action panel.

7

Tap the [Once] key or [Unlimited] key to specify the number of times.

To repeat transmitting an original, tap the [Unlimited] key.
After the settings are completed, tap **OK** and **X**.



8

Tap the [Start] key to start scanning of the original.

- A preview of the image will appear in the touch panel when the original is scanned.
- If you inserted the original pages in the document feeder tray, all pages are scanned.
- When you place the original on the document glass, scan each page one at a time.
When scanning finishes, place the next original and tap the [Start] key. Repeat the procedure until all pages have been scanned and then tap the [Read-End] key.

CHECKING THE DOCUMENT IN THE PUBLIC BOX

You can check the document stored in the machine's memory box (public box) for memory polling.

1

Tap the [Others] key, and tap the [Memory Box] key.

2

Tap the [Polling Memory] tab.

3

Tap the [Public Box] key from the folder list.

When a document is not stored in the Public Box, the [Public Box] key is greyed out.

4

Tap [Check Image] on the action panel to check the document.

To print the document, tap [Print] on the action panel.



DELETING A DOCUMENT FROM THE PUBLIC BOX

Delete a document from the memory box (public box) when it is no longer required.

1

Tap the [Others] key, and tap the [Memory Box] key.

2

Tap the [Polling Memory] tab.

3

Tap the [Public Box] key from the folder list.

4

Tap [Empty out Box] on the action panel.



If you tap [Check Image] on the action panel, you can check the image on the touch panel before it is erased.

5

Tap the [Yes] key.

- The document is deleted and you return to the screen of step 2.
- If you tap [Check Image] on the action panel, you can check the image on the touch panel before it is erased.



To cancel the document deletion:
Tap the [No] key.



PERFORMING F-CODE COMMUNICATION

This section explains how to enter a destination from the initial screen of normal mode.

► [SELECTING FAX MODE \(page 4-8\)](#)

F-CODE COMMUNICATION

F-CODE COMMUNICATION

This function allows the machine to communicate with other machines that also support F-code.

It enables exchange of confidential documents (confidential communication), retrieval (polling) and distribution (polling memory) of information, distribution of information to multiple destinations (relay broadcast transmission) with other machines that support F-code communication. An F-code* is specified in each communication, enabling a higher level of security.

* F-code is a communication function based on the G3 standard of the ITU-T.

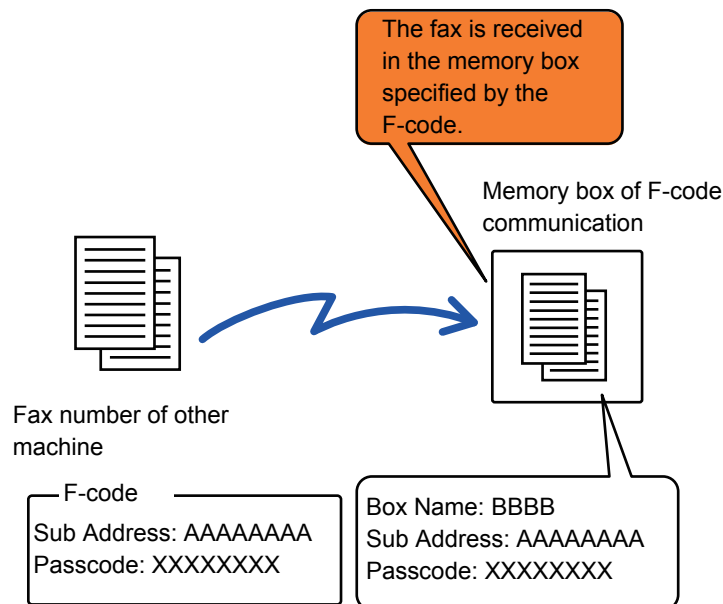

The ITU-T is a United Nations organization that establishes communications standards. It is a department of the International Telecommunication Union (ITU), which coordinates global telecommunications networks and services.



How F-codes work

A fax that is transmitted with an F-code is received in the memory box of F-code communication in the receiving machine specified by the F-code (sub-address and passcode). If the F-code sent by the transmitting machine does not match the F-code in the receiving machine, reception will not take place.

The products of other manufacturers may use different terms for "Sub Address" and "Passcode". If you need to contact the operator of another machine regarding sub-addresses and passcodes, refer to the terms used by the ITU-T in the table below.

The machine	ITU-T		
	F-code polling memory box	F-code confidential box	F-code relay broadcasting function
Sub Address	SEP	SUB	SUB
Passcode	PWD	SID	SID



An F-code consists of a sub-address and passcode, and cannot be longer than 20 digits.

CREATING MEMORY BOXES IN THE MACHINE FOR F-CODE COMMUNICATION

Before the F-code communication function can be used, special memory boxes must be created in "Settings".

Set the box name and F-code (sub-address and passcode) in each memory box, and store them.

After you have created a memory box, notify the other party of F-code communication of the sub-address and passcode of the box.

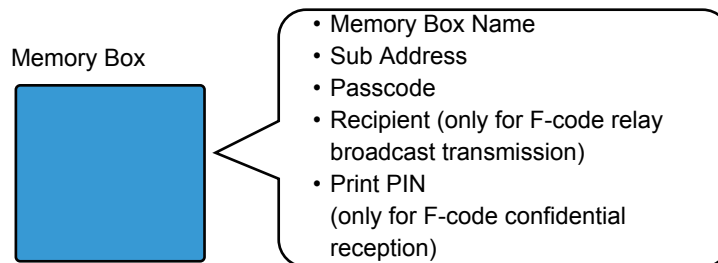

To create F-code memory boxes:

Create in "Settings" - [System Settings] → [Image Send Settings] → [Fax Settings] → [F-Code Memory Box].

To use the following F-code communication functions, F-code memory boxes must be created in your machine.

- F-code confidential reception
- F-code polling memory
- F-code relay broadcast transmission

To use the following F-code communication functions, F-code memory boxes must be created in the other machine.

- F-CODE CONFIDENTIAL TRANSMISSION
- F-code polling reception
- F-code relay request transmission



F-CODE DIALLING

When performing an F-code operation, the F-code (sub-address and passcode) is appended to the fax number that is dialled. Check the F-code (sub-address and passcode) stored in the memory box in the other machine before you perform an F-code transmission. It is convenient to store an F-code (sub-address and passcode) together with the fax number in a one-touch key or group key.

To use the following F-code communication functions, your machine must dial the other machine.

- F-CODE CONFIDENTIAL TRANSMISSION
- F-code polling reception
- F-code relay request transmission

To use the following F-code communication functions, the other machine must dial your machine.

- F-code confidential reception
- F-code polling memory
- F-code relay broadcast transmission



If the destination machine does not have a passcode configured in the F-code, do not enter a passcode when dialling that machine.



Communication using the F-code (sub-address and passcode) is not available when dialling using a speaker or manual transmission.



To store and edit one-touch keys and group keys:

Select [Address Book] in "Settings".

F-CODE CONFIDENTIAL TRANSMISSION

By sending a fax to an F-code memory box (confidential) stored in the receiving machine (your machine or the other machine), the sender can direct the transmission specifically to the user of the box.

This is convenient for sending sensitive documents that you do not wish people other than the recipient to see, or when the receiving machine is shared by multiple departments.

To print an F-code confidential fax, the PIN Code must be entered.

► [CHECKING FAXES RECEIVED BY F-CODE CONFIDENTIAL RECEPTION \(page 4-112\)](#)



The F-code (sub-address and passcode) of the memory box to be used should be verified by the sender and the recipient before the fax is sent.



To create F-code memory boxes:

Create in "Settings (administrator)" - [System Settings] → [Image Send Settings] → [Fax Settings] → [F-Code Memory Box].



CONFIDENTIAL TRANSMISSION USING F-CODES

Send a fax to a destination fax number after adding the F-code (sub-address and passcode).



If necessary, the F-code confidential transmission can be used in combination with a broadcast transmission or timer transmission. It is convenient to store this function in a program.



The F-code confidential transmission cannot be registered as a "Favorite" item.

1

Place the original.

Place the original in the document feeder tray of the automatic document feeder, or on the document glass.

- ▶ [AUTOMATIC DOCUMENT FEEDER \(page 1-84\)](#)
- ▶ [DOCUMENT GLASS \(page 1-86\)](#)

2

Specify the destination.

- (1) Tap the [Direct Entry] key.
- (2) Enter the destination line number using the numeric keys.
- (3) Tap the [Sub Address] key.
Symbol "/" is entered.
- (4) Enter the sub-address using the numeric keys.
- (5) Tap the [Passcode] key.
Symbol "/" is entered.
- (6) Enter the passcode using the numeric keys.



- If the sub-address and passcode are already registered, you can select a one-touch key as well.
- If the passcode is omitted for the memory box of destination machine, you can skip Steps (4) and (5).

3

Tap the [Start] key.

Scanning of the original starts.

- If you inserted the original pages in the document feeder tray, all pages are scanned.
A beep will sound to indicate that scanning and transmission have ended.
- When you place the original on the document glass, scan each page one at a time.
When scanning finishes, place the next original and tap the [Start] key. Repeat until all pages have been scanned and then tap the [Read-End] key.
A beep will sound to indicate that transmission has ended.



You can tap the [Preview] key to check a preview of the image before sending a fax. For more information, see "[CHECKING THE IMAGE TO BE TRANSMITTED \(page 4-30\)](#)". However, settings for this function cannot be changed in the preview screen.



CHECKING FAXES RECEIVED BY F-CODE CONFIDENTIAL RECEPTION

When an F-code confidential fax received, the fax is stored in the memory box specified by the F-code. To check received faxes, enter the PIN Code.



- Confidential faxes are automatically given priority in the print job queue.
- The fax is automatically cleared from the memory box after being printed.



To print transaction report automatically when an F-code confidential fax is received:

In "Settings", select [System Settings] → [Image Send Settings] → [Fax Settings] → [Default Settings] → [Transaction Report Print Select Setting] → [Confidential Reception].



If you forget the PIN Code:

There is no way to use the machine to check a PIN Code that has been specified. Exercise care not to forget the PIN Code. Should you forget or need to verify the PIN Code, contact your dealer or nearest authorised service representative.

1

The machine rings and the fax is received.

A beep sounds when reception ends.

2

Tap the [Others] key, and tap the [Memory Box] key.

3

From the [Confidential] tab.

4

Tap the key of the memory box containing the confidential fax.

"" appears in the keys of memory boxes that have received faxes. The keys of memory boxes that have not received faxes are greyed out and cannot be tapped.

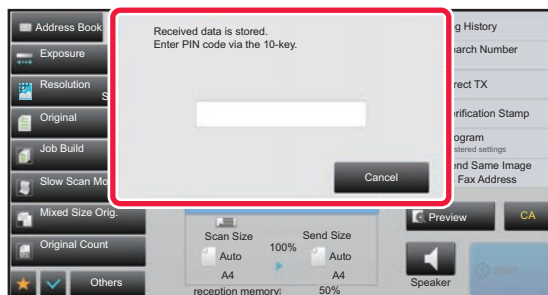
5

Enter the PIN Code using the numeric keys.



Take care to enter the correct PIN Code. If you make a mistake, a message will appear and you will return to the entry screen. You can tap the [Cancel] key to return to step 4.



6

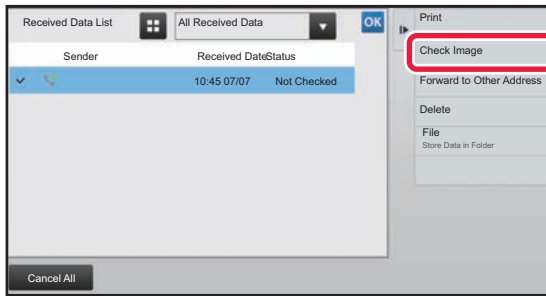

Tap the key of the received data you wish to check, and tap [Check Image] on the action panel.

Displays the received data image.

To print the document, tap [Print] on the action panel.

POLLING RECEPTION USING F-CODES

This function enables your machine to call another machine and initiate reception of a fax stored in an F-code memory box (polling memory) in the other machine. During the polling operation, your machine must correctly specify the F-code (sub-address and passcode) configured in the other machine. Otherwise, polling reception will not take place.

Transmission request (Polling) using an F-code

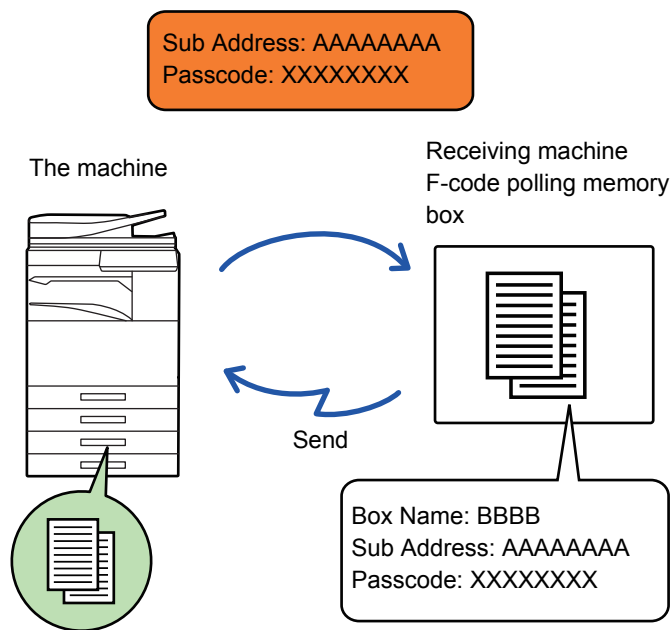

- Verify the F-code (sub-address and passcode) of the memory box in the other machine before you perform F-code polling reception.
- The receiving machine bears the telephone charges of the transmission.
- If necessary, use the F-code polling reception in combination with a broadcast transmission or timer transmission. Only one polling reception with a timer setting can be stored at a time.
 - [SPECIFYING THE TIME FOR COMMUNICATION \(page 4-100\)](#)



- Polling multiple machines (serial polling) is not possible.
- Make sure there is no original in the machine when using the F-code for the polling reception function.
- The polling reception using the F-code cannot be registered as a "Favorite" item.



1

Tap the [Others] key, and tap the [Polling] key.

A checkmark appears on the icon.
After the settings are completed, tap the [Back] key.



To cancel the Polling setting:

Tap the [Polling] key to clear the checkmark.

2

Specify the destination.

- (1) Enter the destination line number using the numeric keys.
- (2) Tap the [Sub Address] key.
Symbol "/" is entered.
- (3) Enter the sub-address using the numeric keys.
- (4) Tap the [Passcode] key.
Symbol "/" is entered.
- (5) Enter the passcode using the numeric keys.



- If the sub-address and passcode are already registered, you can select a one-touch key as well.
- If the passcode is omitted for the memory box of destination machine, you can skip Steps (4) and (5).

3

Tap the [Start] key.

Your machine will call the other machine and initiate reception of the fax.



SCANNING A DOCUMENT INTO A MEMORY BOX FOR F-CODE POLLING TRANSMISSION

When your machine receives a transmission request from another machine, this function sends a fax stored in an F-code memory box (polling memory) in your machine to that machine. The other machine must correctly specify the F-code (sub-address and passcode) configured in your machine. Otherwise, transmission will not take place. An original to be sent to the other machine using F-code polling communication must be previously scanned into an F-code memory box (polling memory) in your machine.

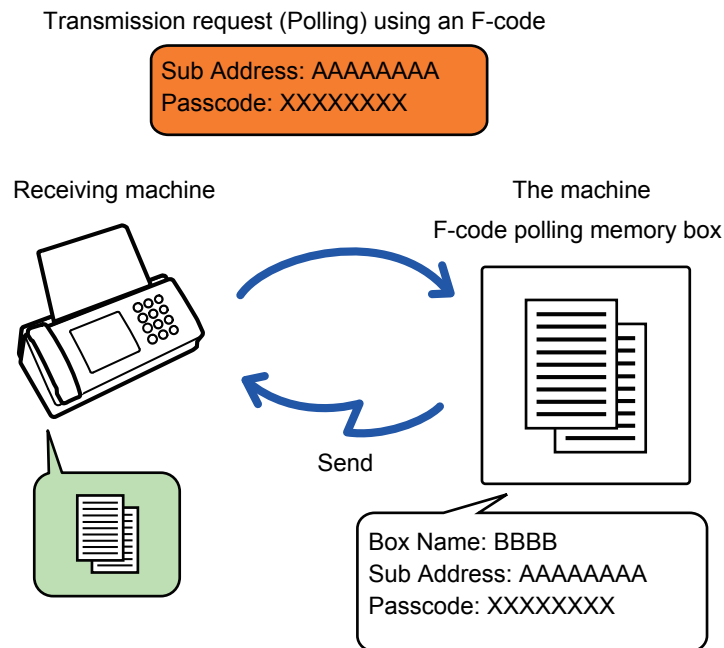

- If other documents have already been stored in the memory box, the document is added to the previously stored documents.
- By factory default, the document sent to the other machine will be deleted automatically.



To create F-code memory boxes:

Create in "Settings (administrator)" - [System Settings] → [Image Send Settings] → [Fax Settings] → [F-Code Memory Box].

1

Place the original.

Place the original in the document feeder tray of the automatic document feeder, or on the document glass.

- ▶ [AUTOMATIC DOCUMENT FEEDER \(page 1-84\)](#)
- ▶ [DOCUMENT GLASS \(page 1-86\)](#)

2

Select settings for the original to be scanned and other functions.



You cannot set the Program, Timer, Transaction Report, Polling, and Document Filing.



3

Tap the [Others] key, and tap the [Memory Box] key.

4

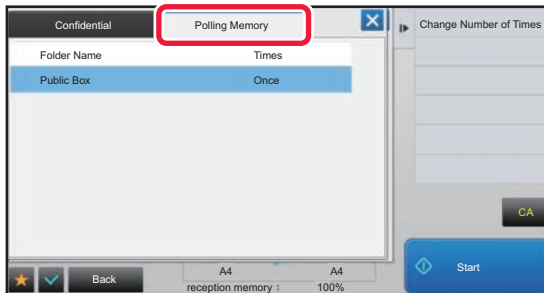

Tap the [Polling Memory] tab.

5

Tap the folder of the F-code memory polling box.

6

Tap [Change Number of Times] on the action panel, and set the polling times.

To erase the original after its transmission, tap the [Once] key. To repeat transmitting an original, tap the [Unlimited] key. Change the settings as necessary.

After the settings are completed, tap **OK**, **X** and [Back] keys.

7

Tap the [Start] key.

Scanning of the original starts.

- If you inserted the original pages in the document feeder tray, all pages are scanned.
- When you place the original on the document glass, scan each page one at a time.
- When scanning finishes, place the next original and tap the [Start] key.
Repeat until all pages have been scanned and then tap the [Read-End] key.



You can tap the [Preview] key to check a preview of the image before sending a fax. For more information, see "[CHECKING THE IMAGE TO BE TRANSMITTED \(page 4-30\)](#)". However, settings for this function cannot be changed in the preview screen.



CHECKING THE DOCUMENT IN THE F-CODE MEMORY POLLING BOX

You can check the document stored in the F-code memory polling box.



A document in a memory box cannot be printed while the document is being transmitted. By factory default, the document sent to the other machine will be deleted automatically.

1

Tap the [Others] key, and tap the [Memory Box] key.

2

Tap the [Polling Memory] tab.

3

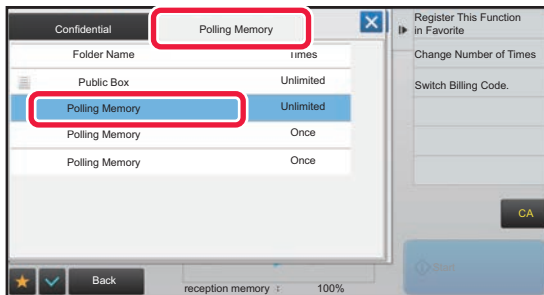

Tap the folder of the F-code memory polling box.

4

Tap [Check Image] on the action panel.

To print the document, tap the [Print] key.



DELETING A DOCUMENT STORED FOR F-CODE POLLING TRANSMISSION

Delete the document stored in an F-code memory polling box in order to be able to store a new document.



No original can be deleted from the memory box during communication.

1

Tap the [Others] key, and tap the [Memory Box] key.

2

Tap the [Polling Memory] tab.

3

Tap the folder of the F-code memory polling box.

4

Tap [Empty out Box] on the action panel.

If you tap [Check Image] on the action panel, you can check the image on the touch panel before it is erased.

5

Tap the [Yes] key.

The document is deleted, and you return to Step 2.



To cancel the document deletion:

Tap the [No] key.



RELAY REQUEST TRANSMISSION USING F-CODES

This function sends a fax to an F-code relay broadcast memory box in another machine and have that machine relay the fax to multiple destination machines.

When the destination machines are far from your machine, sending the fax to a relay machine that is close to the destination machines can help reduce telephone charges. A relay request transmission can be used in combination with the timer transmission function to further reduce cost.

► [SPECIFYING THE TIME FOR COMMUNICATION \(page 4-100\)](#)

The fax is transmitted in sequence to the end receiving machines registered in the F-code relay broadcast memory box.

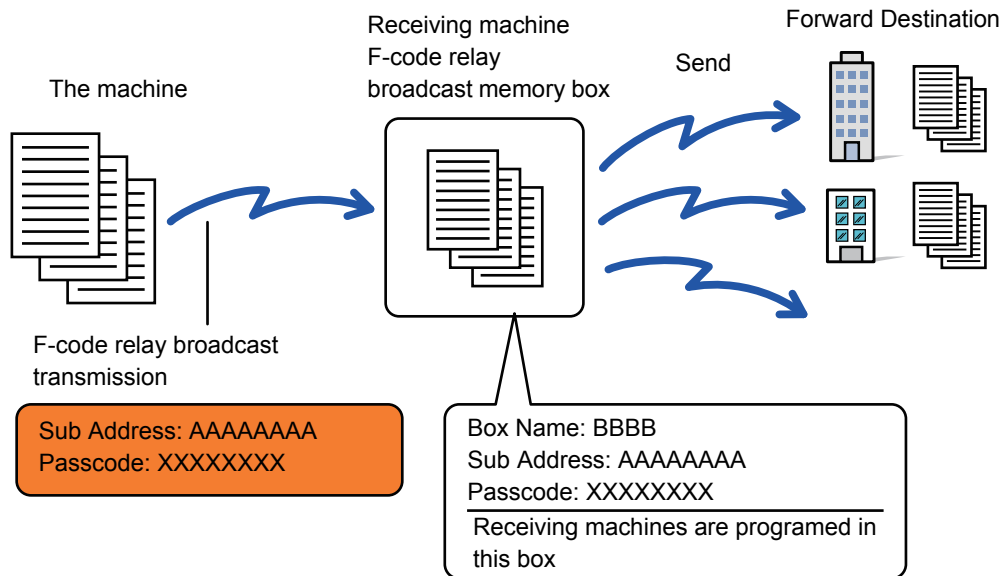

- F-code (sub-address and passcode) and the destination in the F-code relay broadcast memory box of the recipient machine should be verified by the recipient in advance.
- Before using this function, program the destination machines in the F-code relay broadcast memory box in the relay machine.
- It is not necessary for the destination machines to support F-code communication.
- Your machine (the machine that requests a relay broadcast transmission) only bears the cost of sending the fax to the relay machine. The relay machine bears the cost of sending the fax to each of the destination machines.
- If necessary, this function can be used in combination with a broadcast transmission or timer transmission. It is convenient to store this function in a program.



When faxes forwarded using this function are printed at the forwarding destination, the date and time of reception cannot be printed on the faxes. ("Receiving Date & Time Print" is disabled.)



To create F-code memory boxes:

Create in "Settings (administrator)" - [System Settings] → [Image Send Settings] → [Fax Settings] → [F-Code Memory Box].

1

Place the original.

Place the original in the document feeder tray of the automatic document feeder, or on the document glass.

- [AUTOMATIC DOCUMENT FEEDER \(page 1-84\)](#)
- [DOCUMENT GLASS \(page 1-86\)](#)



2

Specify the destination.

- Entering a destination number using the numeric keys ► [page 4-13](#)
- Retrieving a destination from an address book ► [page 4-14](#)
- Using a search number to retrieve a destination ► [page 4-17](#)
- Retrieving a destination from a global address book ► [page 4-18](#)
- Using a transmission log to resend ► [page 4-20](#)



If the sub-address and passcode are stored in the one-touch key, it is not necessary to take steps 3 to 6. Go to step 7.

3

Tap the [Sub Address] key.

Enter "/".

4

Enter the sub-address using the numeric keys.

5

Tap the [Passcode] key.

Enter "/".

6

Enter the passcode using the numeric keys.

If a passcode has been omitted in the memory box of the destination machine, it is not necessary to take steps 5 and 6.

7

Tap the [Start] key.

Scanning begins.

- If you inserted the original pages in the document feeder tray, all pages are scanned.
A beep will sound to indicate that scanning and transmission have ended.
- When you place the original on the document glass, scan each page one at a time.
When scanning finishes, place the next original and tap the [Start] key. Repeat until all pages have been scanned and then tap the [Read-End] key.
A beep will sound to indicate that scanning and transmission have ended.
When the relay machine receives the fax, it will automatically transfer the fax to the destination machines programmed in the memory box.



When you use the automatic document feeder to scan an original, you can tap the [Preview] key to check a preview of the image before sending a fax. For more information, see "[CHECKING THE IMAGE TO BE TRANSMITTED \(page 4-30\)](#)".



RELAY BROADCAST TRANSMISSION USING F-CODES

When your machine receives an F-code relay request transmission, the fax is received and stored in an F-code relay broadcast memory box in your machine.

Your machine then relays the fax to each of the destination machines programmed in the memory box. Transmission to the destination machine takes place automatically.

The fax is transmitted in sequence to the end receiving machines registered in the F-code relay broadcast memory box.

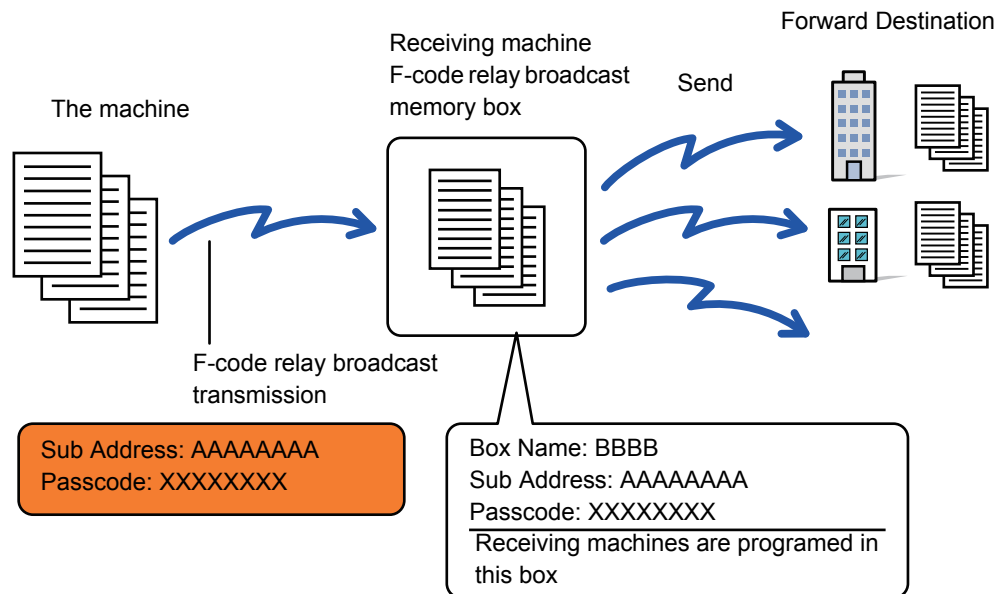

- Prior to carrying out the operation, inform the requesting party, who you will communicate with using F-code relay request transmission, of the sub-address and passcode of the F-code relay broadcast memory box in your machine.
- Program the destination machines in the F-code relay broadcast memory box when you create the box in your machine.
 - [CREATING MEMORY BOXES IN THE MACHINE FOR F-CODE COMMUNICATION \(page 4-109\)](#)
- It is not necessary for the destination machines to support F-code communication.
- The machine that requests a relay broadcast transmission only bears the cost of sending the fax to your machine (the relay machine). Your machine bears the cost of sending the fax to each of the destination machines.
- If both direct SMTP and other sending methods are added to the forwarding destinations, transmission will not take place.



When faxes forwarded using this function are printed at the forwarding destination, the date and time of reception cannot be printed on the faxes. ("Receiving Date & Time Print" is disabled.)



USING AN EXTERNAL TELEPHONE

CONNECTING AN EXTERNAL TELEPHONE

CONNECTING AN EXTENSION TELEPHONE

You can connect an existing telephone to the machine.

The telephone can be used for voice calls and to start fax reception on the machine. Connect the extension telephone as shown below. After connecting an extension telephone, configure the "External Telephone Setting" in setting mode (administrator).

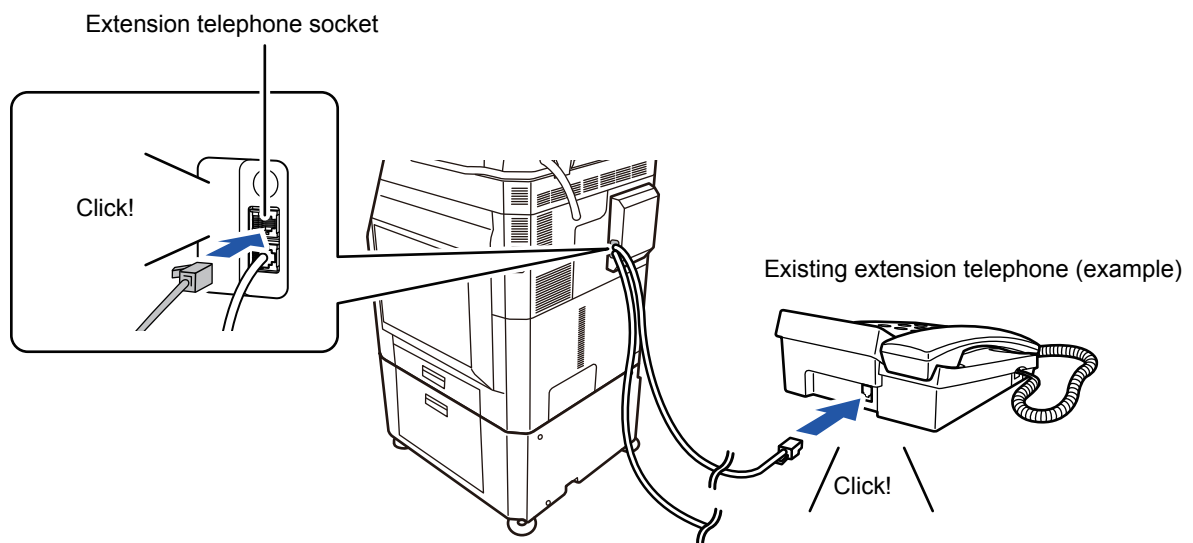

Enable the "Tel/Fax Auto Change" function. This is useful as the telephone or fax operation is selected automatically according to the calling.



- You cannot send a fax from your telephone.
- You can connect a telephone with a modular cable plug to your machine. Also, use the two-wire cable for telephone connection. If another type of cable is used, the telephone may not operate normally.
- If the plug on the telephone line cord does not fit into the socket on your extension phone, contact your dealer or nearest authorised service representative.



RECEIVING A FAX AFTER ANSWERING A CALL ON THE EXTENSION TELEPHONE (REMOTE RECEPTION)

Follow the steps below if you need to start fax reception after answering a call and speaking on the extension telephone. Dial [5], [*] and [*] buttons of the external telephone.

If you are using a pulse line, set the extension to send tone signals.



If the extension phone is still lifted when fax transmission ends, an alarm signal will sound and a message will appear in the touch panel. The alarm and message will stop when the extension phone is replaced.



- **To receive a fax after answering a call on the extension telephone:**

Set "Settings (administrator)" - [System Settings] → [Image Send Settings] → [Fax Data Receive/Forward (Manual)] → [Fax Settings] → [Receive Settings] to [Manual Reception].

- **To change the number to receive faxes:**

In "Settings", select [System Settings] → [Image Send Settings] → [Fax Settings] → [Default Settings] → [Remote Reception Number Setting].

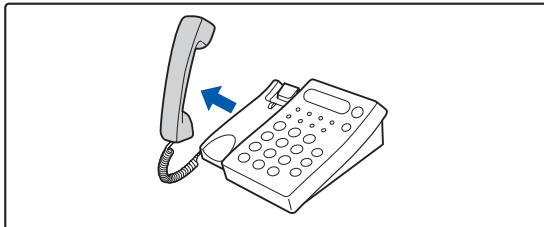
1

While the machine is ringing, pick up the receiver to speak.

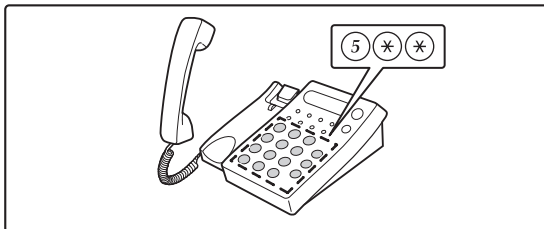
2

Signal the machine to start fax reception.

Press 5 * * from the extension telephone.

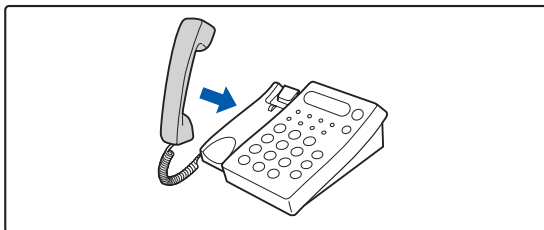
3

Replace the receiver.

The machine beeps when reception ends.

MAKING AND RECEIVING PHONE CALLS

You can make and receive calls like normal on your extension phone. A phone call can also be made by dialling on the machine.



CHECK THE COMMUNICATION STATUS

FAX JOBS

When you tap the job status display, jobs are displayed in a list. To confirm the fax job status, tap the mode display and select the fax.

When you wish to stop or delete jobs or to perform priority processing, read the following items:

- ▶ [STOPPING/DELETING A JOB IN PROGRESS OR RESERVED \(page 1-90\)](#)
- ▶ [PRIORITY PROCESSING OF A RESERVED JOB \(page 1-91\)](#)
- ▶ [CHECKING A RESERVED JOB OR THE JOB IN PROGRESS \(page 1-93\)](#)
- ▶ [CHECKING COMPLETED JOBS \(page 1-94\)](#)

The mode display

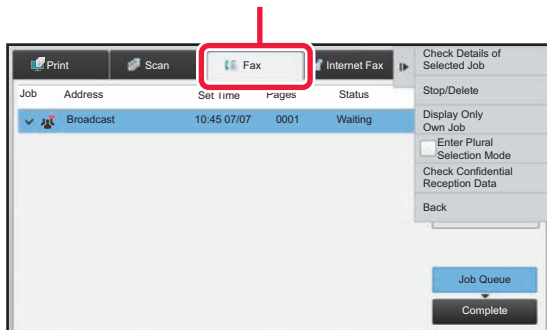

Fax jobs include reception, timer transmission, and data forwarding as well as usual transmission. For information on jobs in fax mode, see "[COMPLETED FAX TRANSMISSION/RECEPTION JOBS \(page 4-124\)](#)".

COMPLETED FAX TRANSMISSION/RECEPTION JOBS

A usual transmission job moves to the job list when transmission is completed. Then the status field displays "Send OK". However, received faxes, timer transmission faxes, retries, fax forwarding, and other fax jobs are displayed in the job status screen as follows:

Fax reception jobs

When a fax is being received, the status field displays "Receiving" in the job queue list.

When reception is completed, the job moves to the completed job list and the status field displays "In Memory". After the fax is printed, the status changes to "Received".

Timer transmission jobs

A timer transmission job appears at the end of the job queue list until the specified time is reached.

Transmission begins at the specified time. When transmission is completed, the job moves to the completed job list and the status field displays "Send OK".



Retry jobs

A retry job appears at the end of the job queue list.

Transmission of the retry job starts according to the [Recall in Case of Line Busy] setting in "Settings". When the transmission is completed, the retry job moves to the completed job list and the status changes to "Send OK".

Reception jobs when the inbound routing settings are enabled

When the inbound routing settings are enabled, reception jobs are handled as follows depending on the print setting.

► [FORWARDING RECEIVED DATA TO PRESET DESTINATIONS \(INBOUND ROUTING SETTINGS\) \(page 4-64\)](#)

Received data is not printed

When a data is being received, "Receiving" appears in the job queue list. When the reception is completed, the status changes to "Waiting".

Received fax is printed

When reception is completed, the status field displays "In Memory" in the completed job list. After the fax is printed, the status changes to "Received". Then a job is added for which the status field displays "Waiting" in the job queue list.

When forwarding the received fax is completed, the field changes to "Forward OK".

CHECKING IMAGE SENDING ACTIVITIES

PRINTING IMAGE SENDING ACTIVITY REPORTS

You can have the machine print a log of recent image sending activity (date, name of other party, time required, result, etc.). The Image Sending Activity Report contains useful information such as the types of errors that occurred.

The most recent 200 transactions are included in the report.

You can have the machine print the Image Sending Activity Report each time the number of transactions reaches 201, or at a specified time (once a day only).



The contents of the Image Sending Activity Report are erased when the report is printed, and thus it cannot be reprinted.



To configure the image sending activity report:

In "Settings", select [System Settings] → [Image Send Settings] → [Fax Settings] → [Default Settings] → [Activity Report Print Select Setting].

INFORMATION APPEARING IN THE RESULT COLUMN

Error types and other information are printed in the result column of transaction and activity reports. When a transaction or activity report is printed, check the result of the transaction in the result column and take action as needed.



Examples of messages that are printed in the result column

Print Page	Description
Yes	The transaction was completed normally.
G3	Communication took place in G3 mode.
ECM	Communication took place in G3 ECM mode.
SG3	Communication took place in Super G3 mode.
Forward	The received data was forwarded.
No Response	No response from the receiving party.
Busy	Transmission was not possible because the other party was already using the line.
No	The transmission was cancelled while in progress.
MEMORY OVER	The memory became full during quick on-line transmission.
FULL	The memory became full during reception.
LENGTH OVER	The transmitted fax was over 59" (1.5 m) long and therefore could not be received.
ORIGINAL ERROR	Direct transmission or manual transmission was not successful because a misfeed occurred.
PASS# NG	The connection was broken because the polling passcode was not correct.
NO RX POLL	The machine that was polled does not have a polling function.
RX POLL FAIL	The other machine refused the polling operation, or your machine broke the connection when polled because no data was in memory.
NO F-CODE POLL	The other machine refused an F-code polling operation, or your machine broke the connection when polled because no data was in its F-code memory polling box.
RX POLL# NG	The connection was broken because the sub-address for F-code polling memory was not valid.
F POLL PASS# NG	The connection was broken because the passcode for F-code polling memory was not valid.
BOX NO. NG	Your machine broke the connection because the specified sub-address for an F-code memory box does not exist.
F PASS# NG	Your machine broke the connection because the other machine sent an incorrect passcode for F-code communication.
RX NO F-CODE POLL	F-code polling was attempted, however, the other machine did not have an F-code polling memory box.
NO F FUNC	F-code communication was attempted, however, the other machine does not support F-code communication.
NO F-CODE	F-code communication was refused by the other machine because of an incorrect sub-address or other reason.
M. BOX: [xxxxxx] *****	Data was received and stored in a confidential or relay broadcast memory box, or data was sent from a memory polling box. The name of the memory box appears in [xxxxxx], and the type of F-code operation (relay request reception, polling memory transmission, or confidential reception) appears in *****.
FAIL xx (xxxx)	The transaction failed due to a communication error. First 2 digits of communication error number: Error code from 00 to 99. Last 4 digits of communication error number: Code for use by service technicians.
Rejected	A fax was sent from a party from which reception is blocked.



SCANNER/ INTERNET FAX

Icons

 Functions you can use in Easy Scan mode

BEFORE USING THE MACHINE AS A NETWORK SCANNER

BEFORE USING THE MACHINE AS A NETWORK SCANNER FUNCTION 5-4

- USES OF THE NETWORK SCANNER 5-4
- BEFORE USING THE NETWORK SCANNER 5-5
- STORING DESTINATIONS FOR SCAN TO DESKTOP 5-7
- BEFORE SENDING TO A DIRECT SMTP ADDRESS 5-7

NETWORK SCANNER MODE 5-8

-  • EASY MODE 5-8
- NORMAL MODE 5-9

SELECTING NETWORK SCANNER MODE 5-9







IMAGE SEND SEQUENCE 5-12

ORIGINAL SIZE 5-14

- TRANSMITTABLE ORIGINAL SIZES 5-14
- THE SIZE OF THE PLACED ORIGINAL 5-14

ENTERING DESTINATIONS

ENTERING DESTINATIONS 5-16

-  • RETRIEVING A DESTINATION FROM AN ADDRESS BOOK 5-16
- MY ADDRESS 5-18
-  • VIEWING A LIST OF THE SELECTED DESTINATIONS 5-19
- USING A SEARCH NUMBER TO RETRIEVE A DESTINATION 5-20
-  • ENTERING AN ADDRESS MANUALLY 5-21
- SPECIFYING A NETWORK FOLDER 5-22
-  • RETRIEVING A DESTINATION FROM A GLOBAL ADDRESS BOOK 5-23
-  • USING A TRANSMISSION LOG TO RESEND 5-25
-  • SENDING ONLY THE URL OF A SCANNED FILE TO A SCAN DESTINATION 5-27

TRANSMITTING AN IMAGE

TRANSMITTING AN IMAGE 5-30

-  • SENDING AN IMAGE IN SCAN MODE 5-30
- CHANGING THE SUBJECT, FILE NAME, REPLY-TO, AND BODY TEXT AT THE TIME OF SCAN TRANSMISSION 5-33

- SENDING A FAX IN INTERNET FAX MODE 5-36

- CHANGING THE SUBJECT, FILE NAME, AND BODY TEXT AT THE TIME OF INTERNET FAX TRANSMISSION 5-38

-  • SENDING THE SAME IMAGE TO MULTIPLE DESTINATIONS (BROADCAST TRANSMISSION) 5-41

-  • SETTING MODES WHEN MULTIPLE TYPES OF ADDRESSES ARE INCLUDED IN A BROADCAST TRANSMISSION 5-43

- RESENDING TO UNSUCCESSFUL BROADCAST TRANSMISSION DESTINATIONS 5-45

- SENDING AN INTERNET FAX FROM A PC (PC-I-FAX) 5-47

IMAGE SETTINGS 5-48

-  • AUTOMATICALLY SCANNING BOTH SIDES OF AN ORIGINAL (2-SIDED ORIGINAL) 5-48

- SCAN SIZE AND SEND SIZE (ENLARGE/REDUCE) 5-49

- SPECIFYING THE ORIGINAL SCAN SIZE IN PAPER SIZE 5-50

- SPECIFYING THE ORIGINAL SCAN SIZE USING NUMERIC VALUES 5-51

- STORING FREQUENTLY USED ORIGINAL SIZES 5-52

- SPECIFYING THE SEND SIZE OF THE IMAGE 5-55

- CHANGING THE EXPOSURE AND ORIGINAL IMAGE TYPE 5-57

-  • CHANGING THE RESOLUTION 5-59

-  • CHANGING FORMAT IN SCAN OR DATA ENTRY MODE 5-60

- CHANGING FORMAT IN INTERNET FAX MODE 5-66

-  • CHANGING COLOUR MODE 5-66

-  • SETTING SCAN SETTINGS AUTOMATICALLY (Auto Set) (MX-3060V/MX-3070V/MX-3560V/MX-3570V/MX-4060V/MX-4070V/MX-5070V/MX-6070V only) 5-68

CHECKING THE IMAGE TO BE TRANSMITTED 5-68





OTHER FUNCTIONS

STORING SCAN OPERATIONS (PROGRAM) 5-69

SCANNING AND SENDING ORIGINALS COLLECTIVELY. 5-72

- SENDING TWO PAGES AS A SINGLE PAGE (N-Up) . . . 5-72
- SCANNING ORIGINALS OF DIFFERENT SIZES (MIXED SIZE ORIGINAL) 5-74
- SCANNING BOTH SIDES OF A CARD ONTO A SINGLE PAGE (CARD SHOT). 5-76
- SIMULTANEOUSLY SCANNING MULTIPLE CARDS, RECEIPTS OR OTHER SMALL ORIGINALS TO INDIVIDUAL FILES (MULTICROP). 5-78
- SCANNING A BUSINESS CARD, READING THE TEXT STRING, CREATING A FILE, AND SENDING THE FILE (BUSINESS CARD SCAN) (MX-3060V/MX-3070V/MX-3560V/MX-3570V/MX-4060V/MX-4070V/MX-5070V/MX-6070V only). 5-80
- SCANNING MULTIPLE PHOTOS AT ONCE TO INDIVIDUAL FILES (Image Crop) 5-84
- SCANNING MANY ORIGINALS AT ONCE (JOB BUILD) 5-86

SCANNING AND SENDING AN ORIGINAL AS SEPARATE PAGES. 5-88

- SCANNING AN ORIGINAL AS TWO SEPARATE PAGES (DUAL PAGE SCAN). . . . 5-88
- SPLITTING A PAMPHLET BY PAGE AND TRANSMITTING THE PAGES SUCCESSIVELY (BOOK DIVIDE) 5-91

ADJUSTING COLOURS AND SHADING 5-93

- ADJUSTING THE BACKGROUND BY MAKING LIGHT AREAS OF THE ORIGINAL DARKER OR LIGHTER (BACKGROUND ADJUSTMENT) 5-93
- ADDING CONTRAST TO THE SCANNED ORIGINAL BEFORE TRANSMISSION (CONTRAST). 5-95
- ENHANCING THE OUTLINE OF THE SCANNED ORIGINAL BEFORE TRANSMISSION (SHARPNESS) 5-97
- REMOVING CHROMATIC COLOURS FROM THE SCANNED ORIGINAL BEFORE TRANSMISSION (DROP OUT COLOUR). . . . 5-99
- ADJUSTING RED/GREEN/BLUE (RGB Adjust) . . . 5-101

SCANNING ORIGINALS 5-103

- ERASING PERIPHERAL SHADOWS ON THE IMAGE (ERASE) 5-103
- SCANNING A THIN ORIGINAL (SLOW SCAN MODE) . . . 5-106
- ELIMINATING BLANK PAGES FROM A TRANSMISSION (BLANK PAGE SKIP) 5-108
- CHECKING THE NUMBER OF SCANNED ORIGINAL SHEETS BEFORE TRANSMISSION (ORIGINAL COUNT). 5-110
- STAMPING SCANNED ORIGINALS (VERIFICATION STAMP) 5-112

SPECIFIC FUNCTIONS 5-114

- ADDING YOUR SENDER INFORMATION TO FAXES (I-FAX OWN ADDRESS SEND) 5-114
- CHANGING THE PRINT SETTINGS FOR THE TRANSACTION REPORT (TRANSACTION REPORT) . . . 5-115
- STARTING A TRANSMISSION AT A SPECIFIED TIME (TIMER TRANSMISSION) . . . 5-117
- ADDING A SIGNATURE WHEN SENDING AN IMAGE (ELECTRONIC SIGNATURE) 5-120
- ENCRYPTING THE TRANSMITTED DATA (ENCRYPTION) 5-122

SENDING A SCANNED DOCUMENT BY GMAIL OR EXCHANGE 5-124

- GMAIL LINK FUNCTION 5-124
- EXCHANGE LINK FUNCTION. 5-126
- SETTINGS SCREEN 5-128

INTERNET FAX RECEPTION FUNCTIONS

CHECKING THE INTERNET FAX ACTIVITY LOG . . . 5-131

- PRINTING IMAGE SENDING ACTIVITY REPORTS 5-131
- INFORMATION APPEARING IN THE RESULT COLUMN 5-132

RECEIVING INTERNET FAXES 5-133

- RECEIVING INTERNET FAXES AUTOMATICALLY 5-133
- RECEIVING INTERNET FAXES MANUALLY . . . 5-133

PRINTING RECEIVED DATA 5-134

- PRINTING A PIN CODE-PROTECTED FAX (Hold setting for received data print) 5-134
- PRINTING RECEIVED DATA AT A SPECIFIED TIME. 5-135
- CHECKING THE IMAGE BEFORE PRINTING. . . . 5-136

FORWARDING RECEIVED DATA 5-138

- FORWARDING RECEIVED INTERNET FAX DATA (FAX DATA FORWARD) 5-138
- FORWARDING RECEIVED DATA TO PRESET DESTINATIONS (INBOUND ROUTING SETTINGS) 5-139
- SAVING RECEIVED FAXES TO THE MACHINE'S HARD DISK (INBOUND ROUTING) 5-142
- FORWARDING RECEIVED DATA MANUALLY . . . 5-144

SAVING RECEIVED DATA. 5-145





CHECKING THE STATUS OF TRANSMISSION/RECEPTION JOBS

- IMAGE SEND JOBS 5-146**
- COMPLETED TRANSMISSION/RECEPTION JOBS.. 5-147**

SCANNING FROM A COMPUTER (PC Scan Mode)

- BASIC SCANNING PROCEDURE..... 5-148**

METADATA DELIVERY

- PREPARATIONS FOR METADATA DELIVERY... 5-153**
 - METADATA DELIVERY (DATA ENTRY) 5-153
 - SETTINGS REQUIRED IN THE SETTING MODE (WEB VERSION)..... 5-154
 - METADATA DELIVERY USING SCAN TO DESKTOP 5-154
- TRANSMITTING METADATA 5-155**
 - TRANSMITTING METADATA 5-155
 - METADATA FIELDS 5-156



BEFORE USING THE MACHINE AS A NETWORK SCANNER

BEFORE USING THE MACHINE AS A NETWORK SCANNER FUNCTION

USES OF THE NETWORK SCANNER

The network scanner allows you to create an image file from the original data scanned by the machine, and send the file over a network to a PC, FTP server, or other destinations. If necessary, it scans the original using a TWAIN-compliant application on your PC.

The network scanner function provides the following scanning modes.

Scanner mode

The scanner function of the machine sends a scanned original as described below based on the specification of the destination.

- **Scan to E-mail**

You can send a scanned file as an e-mail attachment. You can also save the file to the machine's hard disk and send only a URL link (without attaching the file) that allows the recipient to download the file.

- **Scan to FTP**

The scanned file is sent to a specified folder of an FTP server.

When the file is sent, it is also possible to send an e-mail to a previously stored e-mail address to inform the recipient of the location of the file.

- **Scan to Desktop**

The scanned file is sent to a specified folder on your computer.

For information on Scan to Desktop, consult your dealer.

- **Scan to Network Folder**

The scanned file is sent to a network folder on a Windows PC on the same network as the machine.

When the file is sent, it is also possible to send an e-mail to a previously stored e-mail address to inform the recipient of the location of the file.

For the operating procedure, see "[SENDING AN IMAGE IN SCAN MODE \(page 5-30\)](#)".

Internet fax mode

The scanned file is sent as an Internet fax. Internet faxes are received if necessary.

The machine supports Direct SMTP, which lets you directly send Internet faxes within your company without using a mail server.



To use the Internet fax function, the Internet fax expansion kit must be installed.

For the operating procedure, see "[SENDING A FAX IN INTERNET FAX MODE \(page 5-36\)](#)".



Data entry mode

In data entry mode, information entered using the touch panel or automatically generated by the machine is sent to a directory on an FTP server or an application on a PC as a metadata file in XML format.



Installing the application integration module is required to use the metadata delivery function.

The application integration module can be combined with the network scanner to append a metadata file to a scanned image file.

Metadata is information about a file, how it is to be processed, and its relation to other objects.

For the operating procedure, see "[TRANSMITTING METADATA \(page 5-155\)](#)".

BEFORE USING THE NETWORK SCANNER

To use the machine as a network scanner, you must store sender information, configure server settings, store destinations in the address book, and perform other required operations.

1

Make sure the main power switch is in the " I " position.

When the main power indicator is lit up, the main power is in the " I " position. If the main power indicator is not lit up, turn the main power switch to the " I " position and press the [POWER] button on the operation panel.

*If the fax function will be used, and in particular if reception or timer transmission will take place at night, always keep the main power switch in the " I " position.

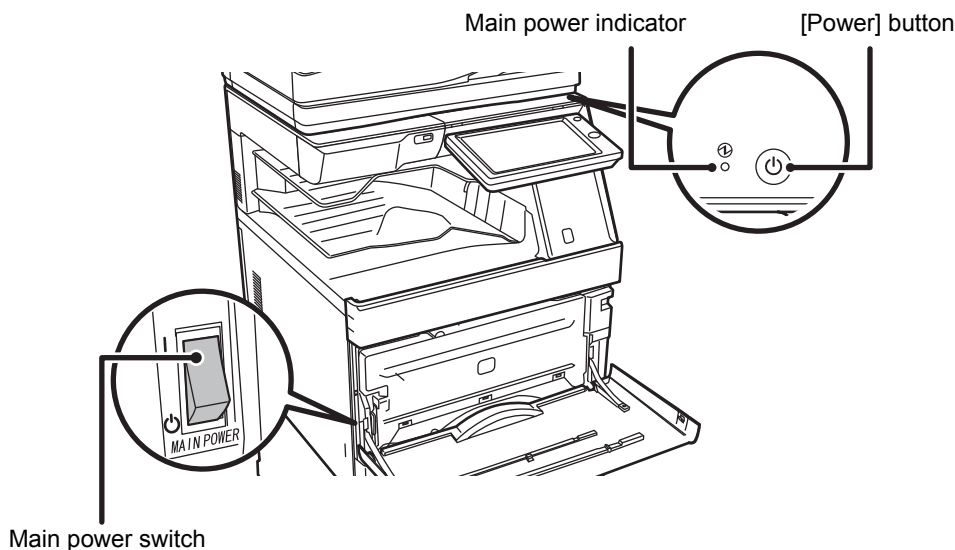

2

Check the date and time.

Verify that the correct date and time are set in the machine.



To set the date and time of the machine:

In "Settings", select [System Settings] → [Common Settings] → [Clock Adjust].



If [Disabling of Clock Adjustment] has been enabled, the date and time cannot be modified.

Select [System Settings] in "Settings (administrator)" → [Common Settings] → [Enable/Disable Settings] → [Operation Settings] to disable the [Disabling of Clock Adjustment] setting.



3

Store the sender information.

Before using Scan to E-mail:

Store a default sender name in "Sender Name" and a reply e-mail address in "Reply E-mail Address".



To store the sender's name and e-mail address that are used when a sender is not selected:

In "Settings (administrator)", select [System Settings] → [Image Send Settings] → [Scan Settings] → [Condition Settings] → [Default Reply.Address Set].

Before using Internet fax:

Store a sender name in "Sender Name" and a sender Internet fax address in "Own Address".

To store the sender's name and address:

In "Settings (administrator)", select [System Settings] → [Image Send Settings] → [Common Settings] → [Own Number and Name Set] → [Sender Data Registration].

4

Configure settings required in the setting mode.

Configure server settings, default settings for the network scanner, and settings for Internet Fax.



- **To configure server settings:**

In "Settings (administrator)", select [System Settings] → [Network Settings] → [Services Settings]. (Administrator rights are required.)

- **To configure basic settings for the network scanner:**

In "Settings (administrator)", select [System Settings] → [Image Send Settings] → [Scan Settings]. (Administrator rights are required.)

- **To configure settings for Internet Fax:**

In "Settings (administrator)", select [System Settings] → [Image Send Settings] and then configure options in [Internet Fax Settings]. (Administrator rights are required.)

5

Store the destination addresses for each scan mode in the address book.

You can send an image by directly entering an address when using Scan to Image. It is convenient to previously store addresses in the address book.

Up to 6000 addresses can be stored in the address book. For information on the address book, see "ADDRESS BOOK".

For how to use the address books and how to store addresses, see the following item.

- ▶ [RETRIEVING A DESTINATION FROM AN ADDRESS BOOK \(page 5-16\)](#)
- ▶ [VIEWING A LIST OF THE SELECTED DESTINATIONS \(page 5-19\)](#)
- ▶ [USING A SEARCH NUMBER TO RETRIEVE A DESTINATION \(page 5-20\)](#)
- ▶ [ENTERING AN ADDRESS MANUALLY \(page 5-21\)](#)
- ▶ [SPECIFYING A NETWORK FOLDER \(page 5-22\)](#)
- ▶ [RETRIEVING A DESTINATION FROM A GLOBAL ADDRESS BOOK \(page 5-23\)](#)
- ▶ [USING A TRANSMISSION LOG TO RESEND \(page 5-25\)](#)



STORING DESTINATIONS FOR SCAN TO DESKTOP

To store your computer in the machine as a destination for Scan to Desktop, Network Scanner Tool must be installed. To scan an image to your computer, Network Scanner Tool must be running on your computer.



To install Network Scanner Tool, see the "Shapdesk Installation Guide". When a standard installation is performed, Network Scanner Tool is installed with Sharpdesk.

BEFORE SENDING TO A DIRECT SMTP ADDRESS

The machine supports Direct SMTP, which lets you directly send Internet faxes within your company without using a mail server.

For the procedure for storing the Direct SMTP address in the address book, see "[STORING ADDRESSES THROUGH DIRECT ENTRY \(page 1-102\)](#)", "[STORING ADDRESSES THROUGH GLOBAL ADDRESS SEARCH \(page 1-103\)](#)" or "[STORING GROUPS \(page 1-106\)](#)". Stored Direct SMTP addresses are included in the address book for Internet fax mode.

If the destination is busy:

If the destination is busy, the machine will wait briefly and then automatically resend.



To cancel transmission:

Do so from the job status screen.

► [STOPPING/DELETING A JOB IN PROGRESS OR RESERVED \(page 1-90\)](#)



To set the number of recall attempts and the interval between attempts when the connection cannot be established because the line is busy, or for other reasons:

In "Settings (administrator)", select [System Settings] → [Image Send Settings] → [Internet Fax Settings] → [Send Setting] → [Recall in Case of Line Busy].

When a communication error occurs:

If a communication error occurs or the other fax machine does not answer the call within a preset period of time, transmission will automatically be attempted again after a preset interval.



To cancel transmission:

Do so from the job status screen.

► [STOPPING/DELETING A JOB IN PROGRESS OR RESERVED \(page 1-90\)](#)



To set the number of recall attempts and the interval between attempts when a transmission fails due to an error:

In "Settings (administrator)", select [System Settings] → [Image Send Settings] → [Internet Fax Settings] → [Send Setting] → [Recall in Case of Communication Error].



NETWORK SCANNER MODE

Network scanner mode has two modes: easy mode and normal mode.

Easy mode is limited to frequently used functions that allow you to smoothly perform most image send jobs.

If you need to select detailed settings or special functions, use normal mode. All functions can be used in normal mode.

EASY MODE

Easy mode makes it easy to select basic settings for network scanner mode.

1st screen

The original size is displayed.

Set an address.

Reset the address and settings.

Scans the original and shows a preview image.

Tap to display the soft keyboard.

Change to normal mode. ► [NORMAL MODE \(page 5-9\)](#)

Change the function display.

Starts black and white or colour transmission.

Automatically set the original placement orientation, resolution, and skipping of blank pages. (MX-3060V/MX-3070V/MX-3560V/MX-3570V/MX-4060V/MX-4070V/MX-5070V/MX-6070V only)

► [PREVIEW SCREEN \(page 1-17\)](#)

2nd screen

Select the function you want to use.

You can select these functions in easy mode.

- Original ► [page 5-57](#)
- Resolution ► [page 5-59](#)
- File Format ► [page 5-60](#)
- Blank Page Skip ► [page 5-108](#)



To select a function in easy mode

In "Settings (administrator)", select [System Settings] → [Common Settings] → [Operation Settings] → [Easy Mode Settings] → [Easy Scan]



NORMAL MODE

Normal mode lets you select any function setting that can be used for network scanner.

This section explains the keys on a base screen, taking as an example the E-mail base screen. Several methods are available in the Image Send mode, including Scan to E-mail and Scan to FTP. The base screen layout slightly differs depending on how image is sent.

Tap to display the soft keyboard.

Enter subject, file name, and other items.

Searches for the address.

Displays the address box to enter addresses.

Displays the functions that can be used in image send mode.

Setting keys used for image send operations.

Scans the original and shows a preview image. ▶ [PREVIEW SCREEN \(page 1-17\)](#)

Displays the list of setting keys. Frequently used [Others], programs, and other settings can be registered.

Reset the address and settings.

Check the current settings.

Displays keys other than the function keys indicated above.

Displays the sizes of the original and the data to send.

Transmission will start immediately.

Enter reply address and body text.

SELECTING NETWORK SCANNER MODE

You can select the network scanner mode from the Home Screen or from each operation mode as follows:

Changing modes from the Home Screen

Tap a mode icon to switch from the home screen to that mode.

Shift to Easy Mode

Tap the [Easy Scan] mode icon.

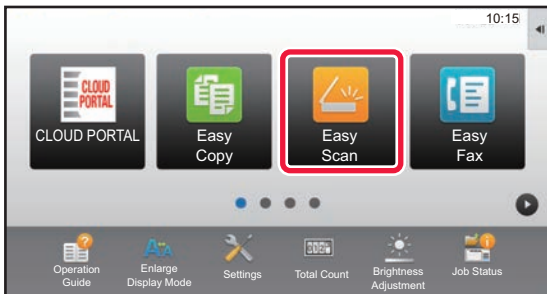

Shift to Normal Mode

Tap the [E-Mail], [FTP/Desktop], [Network Folder] or [Internet Fax] mode icon.

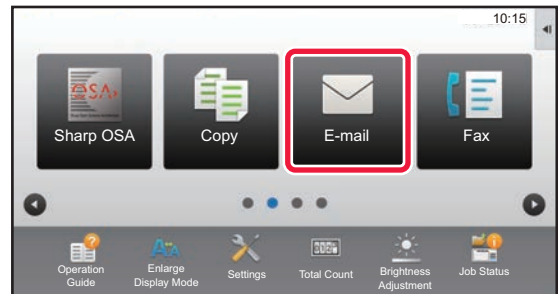

To use the Internet fax function, the Internet fax expansion kit must be installed.



Changing mode from each mode

Tap the mode display to switch from each mode.

Shift to Easy Mode

1

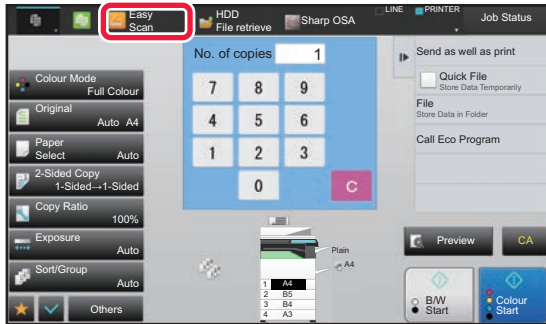

Tap [Easy Scan].

The initial easy scan screen is displayed.



Shift to Normal Mode

1



Tap on the mode display

2

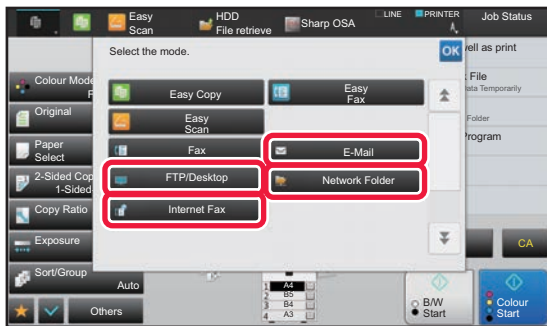

Tap the [E-Mail], [FTP/Desktop], [Network Folder] or [Internet Fax] key.

The initial screen of the selected mode is displayed.



To switch from the base screen of easy mode, tap the [Detail] key and then tap the [Yes] key in the confirmation screen.

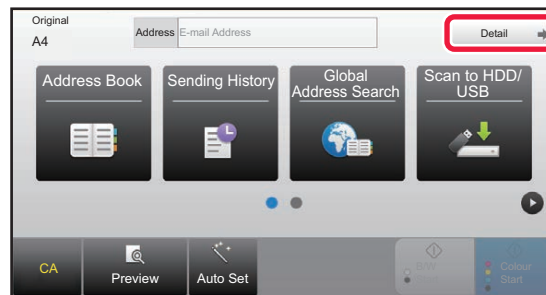

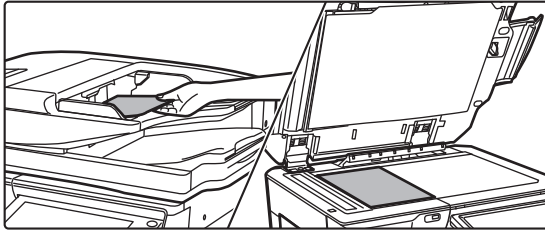

IMAGE SEND SEQUENCE

First, to place the machine in a desired image send mode, tap the appropriate icon in the Home screen.

▶ [CHANGING MODES \(page 1-16\)](#)

1



Place the original.

Place the original in the document feeder tray of the automatic document feeder, or on the document glass.

- ▶ [AUTOMATIC DOCUMENT FEEDER \(page 1-84\)](#)
- ▶ [DOCUMENT GLASS \(page 1-86\)](#)

2

Enter the destination.

Tap the address key to directly enter the destination, or search and retrieve the address book or destination.

In Easy mode

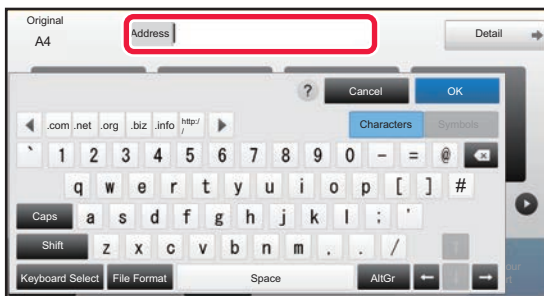

- ▶ [ENTERING AN ADDRESS MANUALLY \(page 5-21\)](#)
- ▶ [RETRIEVING A DESTINATION FROM AN ADDRESS BOOK \(page 5-16\)](#)
- ▶ [USING A TRANSMISSION LOG TO RESEND \(page 5-25\)](#)
- ▶ [RETRIEVING A DESTINATION FROM A GLOBAL ADDRESS BOOK \(page 5-23\)](#)

In Normal mode

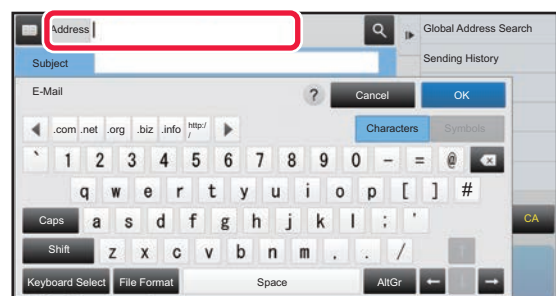

- ▶ [ENTERING AN ADDRESS MANUALLY \(page 5-21\)](#)
- ▶ [RETRIEVING A DESTINATION FROM AN ADDRESS BOOK \(page 5-16\)](#)
- ▶ [USING A SEARCH NUMBER TO RETRIEVE A DESTINATION \(page 5-20\)](#)
- ▶ [RETRIEVING A DESTINATION FROM A GLOBAL ADDRESS BOOK \(page 5-23\)](#)
- ▶ [USING A TRANSMISSION LOG TO RESEND \(page 5-25\)](#)
- ▶ [VIEWING A LIST OF THE SELECTED DESTINATIONS \(page 5-19\)](#)
- ▶ [SPECIFYING A NETWORK FOLDER \(page 5-22\)](#)



3

Select functions.

Specify the original scan size, exposure, file format, and other items.
If necessary, you can refer to the following functions for the setting.

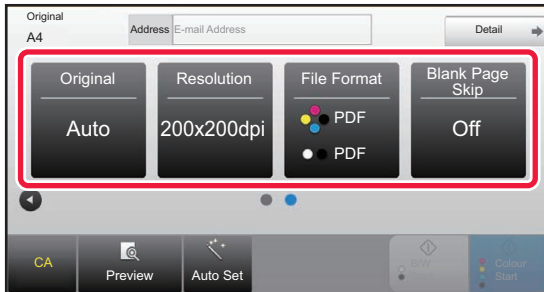
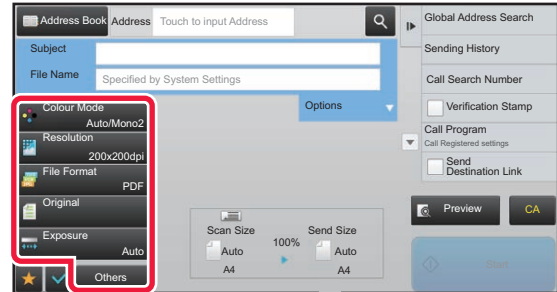
In Easy mode**In Normal mode**

- ▶ [AUTOMATICALLY SCANNING BOTH SIDES OF AN ORIGINAL \(2-SIDED ORIGINAL\) \(page 5-48\)](#)
- ▶ [CHANGING THE RESOLUTION \(page 5-59\)](#)
- ▶ [CHANGING FORMAT IN SCAN OR DATA ENTRY MODE \(page 5-60\)](#)
- ▶ [ELIMINATING BLANK PAGES FROM A TRANSMISSION \(BLANK PAGE SKIP\) \(page 5-108\)](#)

- ▶ [SCANNING AND SENDING ORIGINALS COLLECTIVELY \(page 5-72\)](#)
- ▶ [ADJUSTING COLOURS AND SHADING \(page 5-93\)](#)
- ▶ [SCANNING ORIGINALS \(page 5-103\)](#)
- ▶ [AUTOMATICALLY SCANNING BOTH SIDES OF AN ORIGINAL \(2-SIDED ORIGINAL\) \(page 5-48\)](#)
- ▶ [SCAN SIZE AND SEND SIZE \(ENLARGE/REDUCE\) \(page 5-49\)](#)
- ▶ [SPECIFYING THE ORIGINAL SCAN SIZE IN PAPER SIZE \(page 5-50\)](#)
- ▶ [SPECIFYING THE ORIGINAL SCAN SIZE USING NUMERIC VALUES \(page 5-51\)](#)
- ▶ [SPECIFYING THE SEND SIZE OF THE IMAGE \(page 5-55\)](#)
- ▶ [CHANGING THE EXPOSURE AND ORIGINAL IMAGE TYPE \(page 5-57\)](#)
- ▶ [CHANGING THE RESOLUTION \(page 5-59\)](#)
- ▶ [CHANGING FORMAT IN SCAN OR DATA ENTRY MODE \(page 5-60\)](#)
- ▶ [CHANGING FORMAT IN INTERNET FAX MODE \(page 5-66\)](#)
- ▶ [CHANGING COLOUR MODE \(page 5-66\)](#)

4

Send the original.

Tap the [B/W Start] or [Colour Start] key ([Start] key in normal mode).



- You can tap the [Preview] key before tapping the [B/W Start] key or the [Colour Start] key (the [Start] key in normal mode) to check a preview of the image.
- When the original is placed on the document glass, repeat the placing original and transmission procedures until all originals have been sent. After scanning all originals, tap the [Read-End] key.
- In normal mode, if you tap the [File] or [Quick File] on the action panel before sending image, you can save the scanned original as data.
 - ▶ [USING DOCUMENT FILING IN EACH MODE \(page 6-7\)](#)



ORIGINAL SIZE

TRANSMITTABLE ORIGINAL SIZES

The following original sizes can be transmitted

	Minimum original size	Maximum original size
Using the automatic document feeder	131 mm (height) x 140 mm (width) (5-1/8" (height) x 5-1/2" (width))	297 mm (height) x 1000 mm* (width) (11-5/8" (height) x 39-3/8" (width))
Using the document glass	-	297 mm (height) x 432 mm* (width) (11-5/8" (height) x 17" (width))

*A long original can be transmitted.

THE SIZE OF THE PLACED ORIGINAL

When a standard size original is placed, the original size is automatically detected and displayed in "Scan Size" on the based screen.

► [SCAN SIZE AND SEND SIZE \(ENLARGE/REDUCE\) \(page 5-49\)](#)

Standard sizes are sizes that the machine can automatically detect. The standard sizes are set in "Original Size Detector Setting" in "Settings".



When the automatic original detection function is operating and the original (of inch or non-standard size) is placed, the closest standard size may be displayed or the original size may not appear. In this event, manually set the correct original size.

► [SPECIFYING THE ORIGINAL SCAN SIZE IN PAPER SIZE \(page 5-50\)](#)

► [SPECIFYING THE ORIGINAL SCAN SIZE USING NUMERIC VALUES \(page 5-51\)](#)



To specify the size that the machine can automatically detect:

Select the group of detected original sizes by selecting [System Settings] in "Settings (administrator)" → [Common Settings] → [Device Control] → [Original Size Detector Setting].



List of original size detector settings

Selections	Standard sizes (detected original sizes)	
	Document Glass	Document feeder tray (automatic document feeder)
AB-1	A3, A4, A4R, A5, B4, B5, B5R	11" x 17", 8-1/2" x 14", 8-1/2" x 11", A3, A4, A4R, A5, B4, B5, B5R
AB-2	A3, A4, A4R, A5, B5, B5R 216 mm x 330 mm (8-1/2" x 13")	A3, A4, A4R, A5, B4, B5, B5R, 11" x 17", 8-1/2" x 11", 216 mm x 330 mm (8-1/2" x 13")
AB-3	A4, A4R, A5, B4, 8K, 16K, 16KR	A3, A4, A4R, A5, B4, 11" x 17", 8-1/2" x 11", 216 mm x 330 mm (8-1/2" x 13"), 8K, 16K, 16KR
AB-4	A3, A4, A4R, A5, B5, B5R 216 mm x 340 mm (8-1/2" x 13-2/5")	A3, A4, A4R, A5, B4, B5, B5R, 11" x 17", 8-1/2" x 11", 216 mm x 340 mm (8-1/2" x 13-2/5")
AB-5	A3, A4, A4R, A5, B5, B5R 216 mm x 343 mm (8-1/2" x 13-1/2")	A3, A4, A4R, A5, B4, B5, B5R, 11" x 17", 8-1/2" x 11", 216mm x 343mm (8-1/2" x 13-1/2")
Inch-1	11" x 17", 8-1/2" x 14", 8-1/2" x 11", 8-1/2" x 11"R, 5-1/2" x 8-1/2"	11" x 17", 8-1/2" x 14", 8-1/2" x 11", 8-1/2" x 11"R, 5-1/2" x 8-1/2", A3, A4
Inch-2	11" x 17", 8-1/2" x 13" (216 mm x 330 mm), 8-1/2" x 11", 8-1/2" x 11"R, 5-1/2" x 8-1/2"	11" x 17", 8-1/2" x 13-2/5" (216 mm x 340 mm), 8-1/2" x 11", 8-1/2" x 11"R, 5-1/2" x 8-1/2", A3, A4
Inch-3	11" x 17", 8-1/2" x 13-2/5" (216 mm x 340 mm), 8-1/2" x 11", 8-1/2" x 11"R, 5-1/2" x 8-1/2"	11" x 17", 8-1/2" x 13-2/5" (216 mm x 340 mm), 8-1/2" x 11", 8-1/2" x 11"R, 5-1/2" x 8-1/2", A3, A4



ENTERING DESTINATIONS

ENTERING DESTINATIONS

RETRIEVING A DESTINATION FROM AN ADDRESS BOOK

In the address book screen, simply tap the one-touch key of a registered destination to retrieve the destination. If necessary, store multiple destinations in a one-touch key. Tapping the key will retrieve all the stored destinations. The address book screen shows all destinations used in each mode. Each one-touch key shows the name of the destination and an icon indicating the mode used for the destination.

	Fax
	Scan to E-mail
	Internet Fax
	Direct SMTP
	Scan to FTP
	Scan to Network Folder
	Scan to Desktop
	Group key with multiple destinations

- For information on the address book, see "[ADDRESS BOOK \(page 1-98\)](#)".
- For the procedure for storing the destinations in the address book, see "[STORING ADDRESSES THROUGH DIRECT ENTRY \(page 1-102\)](#)", "[STORING ADDRESSES THROUGH GLOBAL ADDRESS SEARCH \(page 1-103\)](#)", and "[STORING GROUPS \(page 1-106\)](#)".

1

Tap the [Address Book] key.

In Easy mode

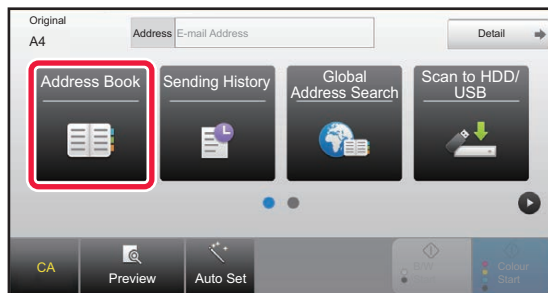

In Normal mode

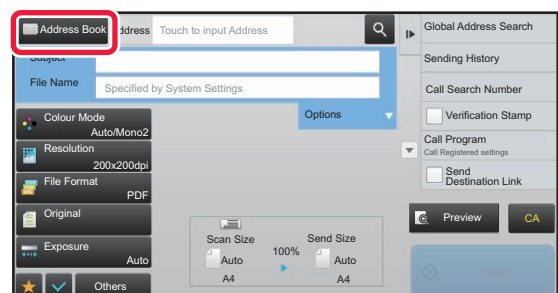



2

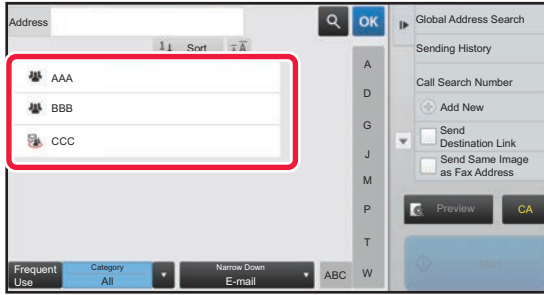

Tap the one-touch key of contact or group that has a destination.

- The destinations displayed on the list can be narrowed with categories, frequent use, indexes, and keywords. (In normal mode you can narrow down by job type.)
- Tapping the [Sort] key allows you to change the order of destinations displayed in the list.
- When adding a destination, tap another one-touch key.
- If two or more destinations are selected or specified, the total number of addresses appears next to address.
- Even if only a single destination is selected, the number of addresses appears when the destination is a contact or group in which multiple addresses are stored.

For more information, see "[ADDRESS BOOK SCREEN \(page 1-99\)](#)".



If you select an incorrect destination:

Tap the key again to cancel the selection.



- To select a destination from the transmission log, tap the [Sending History] key.
 - ▶ [USING A TRANSMISSION LOG TO RESEND \(page 5-25\)](#)
- To check the entered destinations, tap the [Address Review] key.
 - ▶ [VIEWING A LIST OF THE SELECTED DESTINATIONS \(page 5-19\)](#)
- The destination for transmission can be selected by tapping a stored destination.
- If an address that you do not have permission to use is included in the addresses, a message will appear when you press the [Start] key. To send only to the permitted addresses, press the [OK] key and then the [Enter for send] key.

In Normal mode

- Tap the one-touch key, and then tap [Display Registered Information] on the action panel to display the detailed information screen.
- To retrieve a destination by using a search number, tap [Call Search Number] on the action panel.
 - ▶ [USING A TRANSMISSION LOG TO RESEND \(page 5-25\)](#)
- To retrieve a destination from a global address book, tap [Global Address Search] on the action panel.
 - ▶ [RETRIEVING A DESTINATION FROM A GLOBAL ADDRESS BOOK \(page 5-23\)](#)

To cancel a specified destination:

Select the address you want to cancel in the address list screen, and tap the [Delete] key.

To enable transmission to addresses of modes other than the current mode:

Remove the checkmark from [System Settings] → [Image Send Settings] → [Common Settings] → [Condition Settings] → [Address Book Default Selection] → [Apply Addresses of Sending Modes Only] in "Settings (administrator)".



MY ADDRESS

My Address is the user's own e-mail address, and is the e-mail address that has been registered in the user list.

My Address can be used when login by login name / password is enabled in user authentication.

Use this address when you want to send a scanned image to your own e-mail address.

In E-mail mode, [Find My Address] appears on the action panel to let you immediately find and use My Address.

When you use the address book in E-mail mode, the [Find My Address] button also appears at the top of the user list for easy access from the address book.



- My Address cannot be used in the following instances:
 - When address search from the user list is prohibited in the system settings
 - When user authentication is disabled, or is only by user number
 - When [Apply E-mail address of the user for login.] is enabled in [Default Address]
 - When the e-mail address of the logged in user has not been registered
 - After the [Next Address] key is pressed when [Be sure to press Next Address Key ([+]) before selecting the next address.] is enabled in System Settings - [Image Send Settings]→[Common Settings]→[Condition Settings]
 - When [S/MIME Settings]→[Disable sending to the addresses which cannot be encrypted.] is enabled in the security settings
- You can register [Find My Address] in the home screen. This is convenient when you frequently use My Address.



VIEWING A LIST OF THE SELECTED DESTINATIONS

When multiple destinations have been selected, you can display and check the destinations. You can also delete a destination from the list (cancel selection of the destination).

1 Tap the [Address Review] key.

In Easy mode

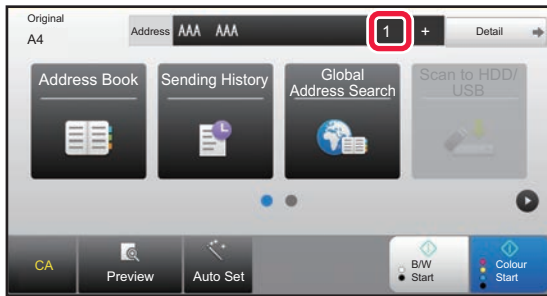

In Normal mode

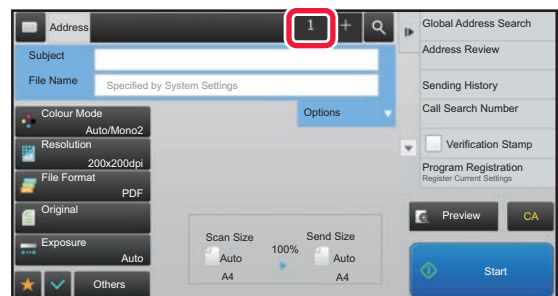

Confirm the destination.
After the confirmation is completed, tap **OK**.



To confirm detailed information such as the type or name of the specified destination, tap the one-touch key of the target destination, and then tap the [Info.] key.
In normal mode, you can change the delivery type (To/Cc/Bcc). Tap the address and then tap [Change to To], [Change to Cc], or [Change to Bcc] on the action panel.

Deleting Specified Destinations

In step 2 of "VIEWING A LIST OF THE SELECTED DESTINATIONS", select the destination and tap the [Delete] key.

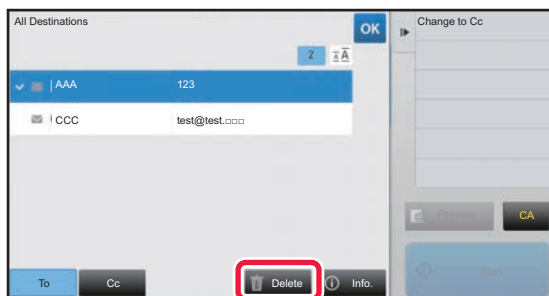

If you placed the original on the document glass and tapped the [Start] key, you cannot delete an address when changing settings.



USING A SEARCH NUMBER TO RETRIEVE A DESTINATION

The search number can be used to specify a destination stored in an address book.

1

Tap the [Detail] key to change to normal mode.

▶ [Changing mode from each mode \(page 5-10\)](#)

2

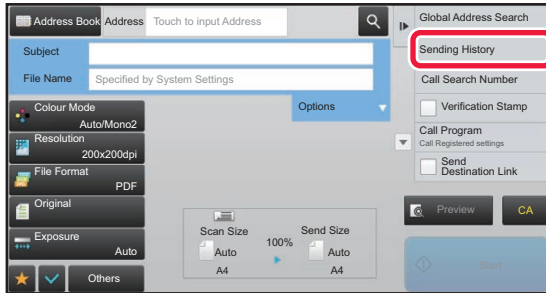

Tap [Call Search Number] on the action panel.

3

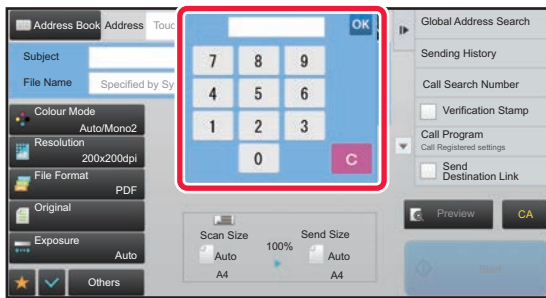

Enter a search number (4 digits) using the numeric keys and tap **OK**.

When the search number is entered, the stored address is retrieved and specified as a destination.



If an incorrect search number is entered:

Tap the [C] key to clear the number and enter the correct number.



- The search number is programmed when the destination is stored in the address book.
- If you do not know the search number, tap [Print Individual List] on the action panel to print and check the address list.
- When entering search numbers such as "0001" and "0011", "0" can be omitted. For example to enter "0001", enter "1" and tap the [OK] key.



ENTERING AN ADDRESS MANUALLY

1

In the base screen of a mode, tap [Text Box].

On the base screen of Internet Fax, tap [Text Box] to display the screen you want to select the address type. Tap either the [Internet Fax] or [Direct SMTP] key.

In easy mode, only the e-mail addresses can be entered.

In Easy mode

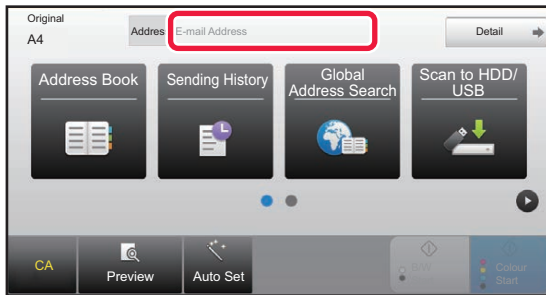

In Normal mode

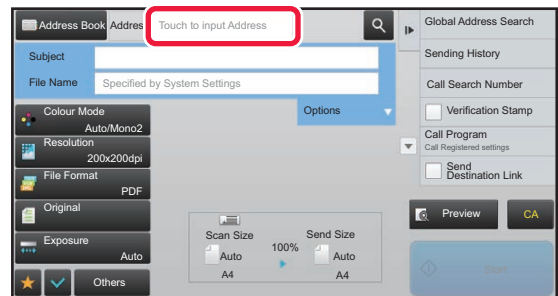

2

Enter the destination address on the soft keyboard that appears.

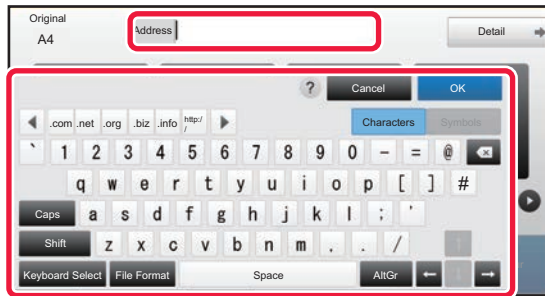

- In data entry mode, select the mode of the destination, and enter the destination address.
- For Scan to Network Folder mode, the network folder entry screen appears. See "[SPECIFYING A NETWORK FOLDER \(page 5-22\)](#)".
- After entering the destination address, tap the [OK] key to close the soft keyboard.



To enter text, see "[NAMES AND FUNCTIONS OF SOFT KEYBOARD KEYS \(page 1-165\)](#)" in the "BEFORE USING THE MACHINE".

- You can select [Bcc] if [Image Send Settings] → [Scan Settings] → [Default Settings] → [Bcc Setting] → [Enable Bcc] is enabled in [System Settings].
- In Internet Fax mode, the transmission confirmation request setting screen will appear if [System Settings] - [Image Send Settings] → [Internet Fax Settings] → [Send Setting] → [I-Fax Reception Report On/Off Setting] is enabled. To request confirmation, tap the [Set] key. To cancel, tap the [Cancel] key. (When Direct SMTP is used, transmission confirmation is not performed.)



SPECIFYING A NETWORK FOLDER

1

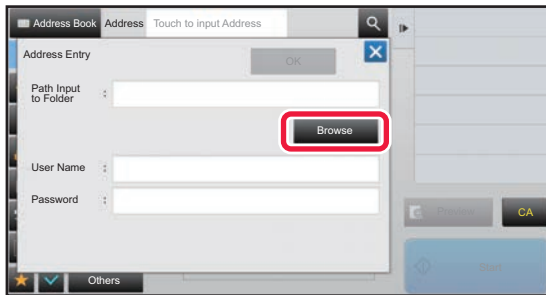

Tap the [Browse] key in the network folder entry screen.

- To directly enter a folder, tap the [Folder Path] box. The soft keyboard is displayed.
- If a user name and password are required, check with the administrator of the server and enter the user name and password.



- To enter text, see "[NAMES AND FUNCTIONS OF SOFT KEYBOARD KEYS \(page 1-165\)](#)" in the "BEFORE USING THE MACHINE"
- If a user authentication function other than authentication by user number is enabled, the login name of the current user is automatically entered in the user name field.

2

Tap the key of the workgroup that you wish to access.



- Tap the [Search] key and enter a keyword to search for a workgroup, server, or network folder.
- Up to 100 workgroups, 100 servers, and 100 network folders are displayed.
- Tap the [Cancel] key to return to the screen of step 1.

3

Tap the key of the server or computer that you wish to access.

If a screen appears prompting you to enter a user name and password, check with your server administrator and enter the appropriate user name and password.

4

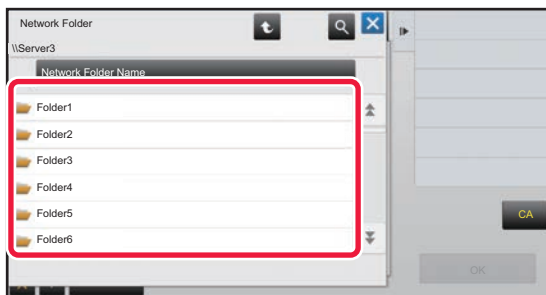

Tap the key of the network folder.

After the settings are completed, tap the [OK] key. You will return to the screen of step 1. Tap the [OK] key again to accept the destination.



RETRIEVING A DESTINATION FROM A GLOBAL ADDRESS BOOK

When an LDAP server is configured in the "Settings (Web version)", look up an address in a global address book and retrieve the destination address for Scan to E-mail or Internet fax transmission (excluding Direct SMTP addresses). In normal mode, you can add an address retrieved by searching to the address book. However, addresses of the FTP/Desktop transmission cannot be stored from the machine.

1 In Easy mode

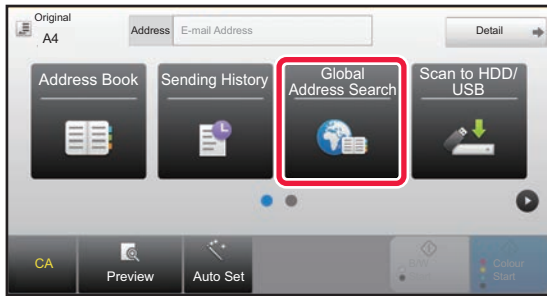

Tap the [Global Address Search] key.

In Normal mode

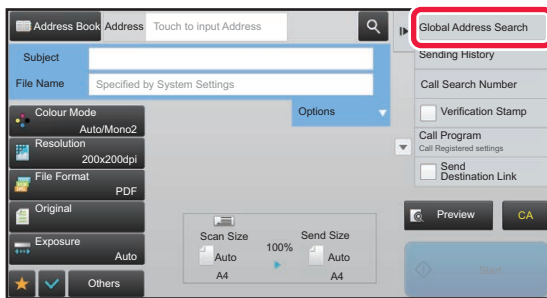

In the base screen or address book screen, tap [Global Address Search] on the action panel.

2

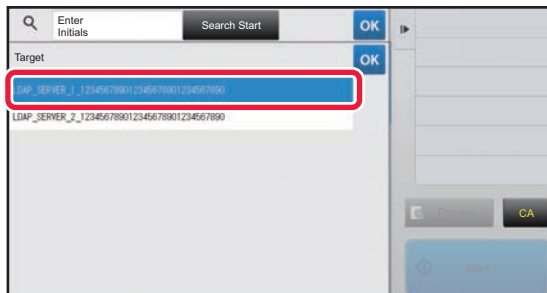



Tap [Destination] and tap the LDAP server to be used.

- If an authentication screen for the LDAP server appears, enter your user name and password.
- If only one LDAP server has been stored, it is not necessary to take step 2. In this case, start from step 3.

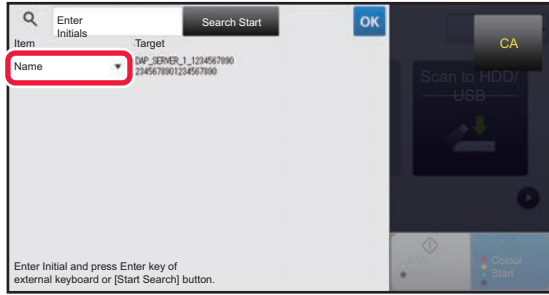

3



Tap  of [Item], and select an item to be searched from [Name] or [Address].

**How to search**

Enter the search characters (maximum of 64 characters). The system will look for names starting with the entered letters.

An asterisk * is used as follows:

- XXX* : Names beginning with "XXX"
- *XXX : Names that end with "XXX"
- *XXX* : Names containing "XXX"
- AA*XX : Names that start with "AA" and end with "XX".

4

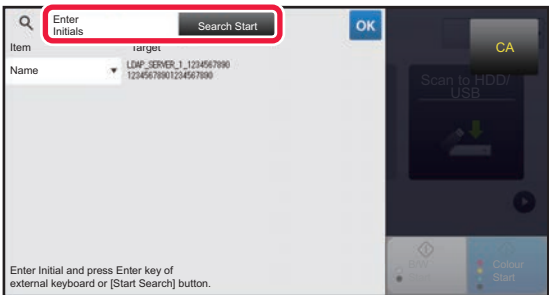

Enter a keyword and tap the [Search Start] key.

When you tap the keyword entry box, the soft keyboard appears.

The search results will appear after a brief interval.



- **If no destination is found:**

Tap the [Search Again] key to add more search letters.

- **To continuously add other destination.**

Tap the destination.

**To check the destination information:**

Tap the one-touch key of the target destination, and then tap the [Info.] key. Tap  to close the address information screen.

In normal mode, you can select an address and tap [New Registration with Address Book] on the action panel to add the address to the address book. This is convenient if you have entered a destination directly.



USING A TRANSMISSION LOG TO RESEND

Select a destination from a transmission log and resend the data.

The destinations of the most recent 50 transmissions by Scan to E-mail, Internet fax (including Direct SMTP addresses), and/or fax are stored. Select one of these to resend to that destination. The destinations of the FTP/Desktop transmission and Scan to Network Folder are also shown in the transmission log.

In normal mode, the addresses shown in the transmission log can also be stored in an address book. This is convenient when storing an address that was manually entered.



- When a destination for retransmission is selected in the transmission log screen, the mode of the selected destination is automatically selected.
- The following types of addresses are not stored for resending.
 - One-touch key for a contact or group in which multiple destinations are stored.
 - Group destinations
 - Broadcasting destinations
- The user name and password are not stored for security reasons. If a screen requiring you to enter such information appears, enter the information again.

1

In Easy mode

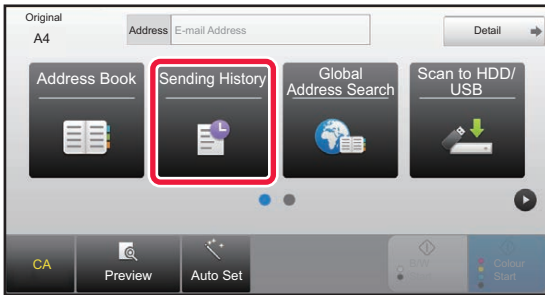

Tap the [Sending History] key

In Normal mode

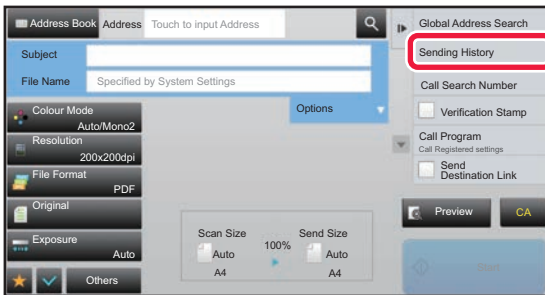

In the base screen or address book screen, tap [Sending History] on the action panel.



2

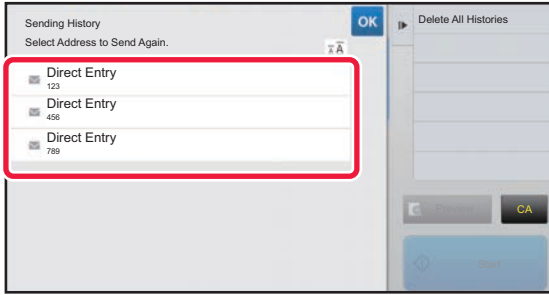

Tap the key of the destination to resend.

The last 50 addresses used for transmission are displayed. If a screen requiring you to enter the user name and password appears, enter the information.



To cancel the resend setting:

Tap the highlighted key.



In normal mode, you can select an address and tap [New Registration with Address Book] on the action panel to add the address to the address book. This is convenient if you have entered a destination directly.



SENDING ONLY THE URL OF A SCANNED FILE TO A SCAN DESTINATION

When using Scan to E-mail, some originals and/or scan settings may result in a large file.

When the file is large, there is a risk that the e-mail server may reject the file and it will not be sent.

This function saves the scanned file on the machine's hard disk, and sends an e-mail providing only the file's URL information to the recipient.

This function helps reduce the load on the e-mail server and prevents non-delivery of scanned files caused by the e-mail server.

Upon receiving the e-mail, the recipient can use the URL in the e-mail to download the scanned file.

When the scanned file is too large

Scan to E-mail

Scanned file

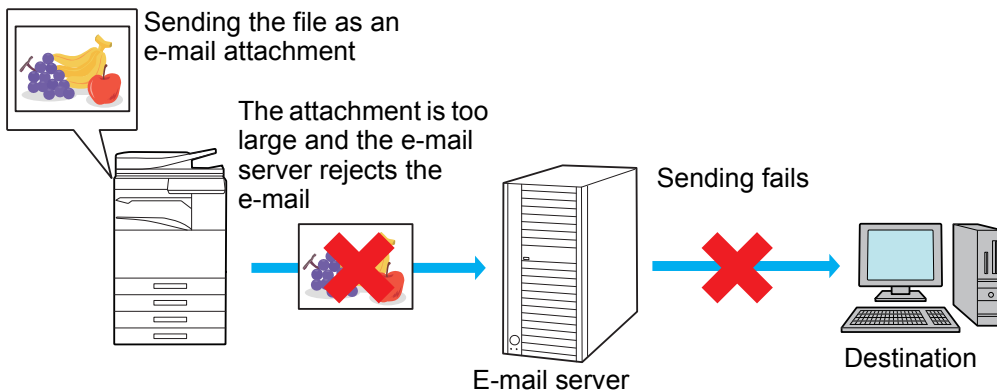

Sending only a URL to the recipient

Scanned file

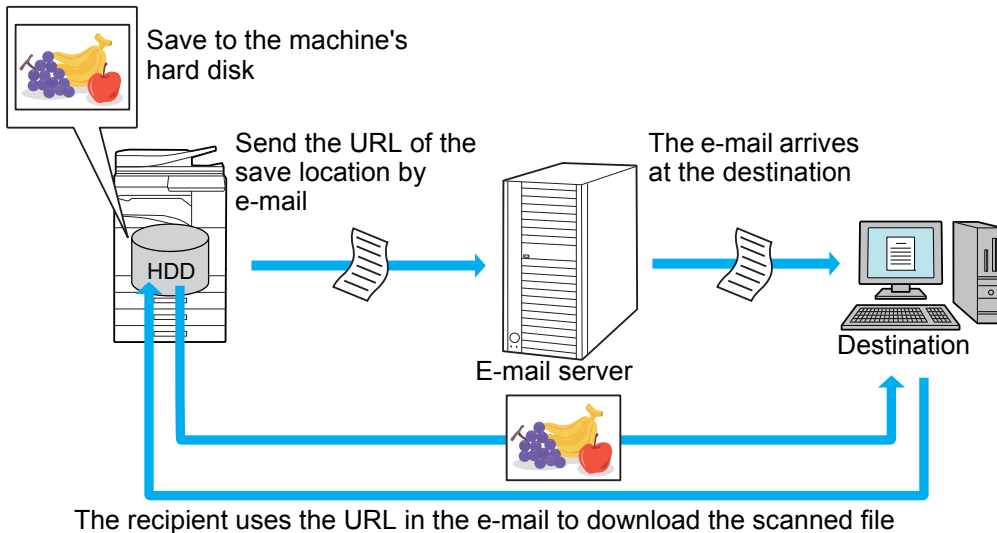



Sending only a URL to the recipient

Using simple mode

When [Enable Send Destination Link as Default] is enabled in the settings (administrator), the scanned data is saved in the machine's hard disk, and URL information is sent to the e-mail destination. When disabled, scanned data is sent by regular Scan to E-mail. This function enable/disable cannot be changed in the simple mode screen.

Using normal mode

[Send Destination Link] appears on the action panel of the home screen of Scan to E-mail. By selecting this checkbox , you can use this function.

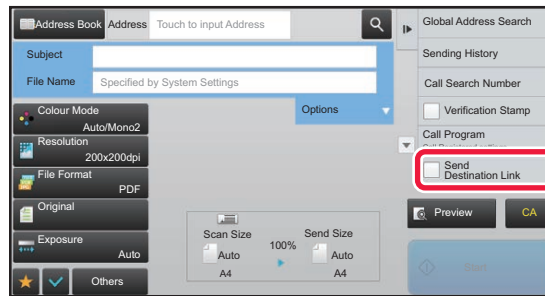

Number of URLs created

One URL is created per file to be downloaded.

Using [One Page per File]

Multiple scanned files will be created and saved at once, and a URL will be created for each file and sent to the recipient.

Using [Programmed]

Files will be created and saved in a format that varies by recipient, and a URL will be created for each file. A URL will be sent to each recipient for the file in the format for that recipient.



- To use this function, [Send Destination Link Settings] must be enabled in the System Settings (administrator).
- This function cannot be used in combination with metadata transmission or resending from document filing.
- Scanned files are saved in the standard folder area.
- Scanned files cannot be browsed by a method other than downloading.
- Scanned files cannot be manually deleted, and are retained for the save period set in the System Settings. However, scanned files will be deleted if Clear All Memory or Initialize Private Data/Data in Machine is executed, or you move to Advanced Security Settings.
- When all destinations in a broadcast transmission are e-mail addresses, URL information is sent to all destinations. If the file format of the saved scan data is the same for all destinations, the same URL will be sent. If the file format varies by destination, separate URLs will be sent.
- If the transmission includes recipients for different jobs (Scan to FTP, Scan to Desktop, etc.), transmission will take place by sending only a URL to the recipient to any e-mail addresses, while the scanned file will be sent directly in the normal way to recipients for other jobs.
- When [Document Administration Function] is enabled in the System Settings (administrator), the scanned file will be sent directly to the administrator, not by URL.
- Even when [Send Destination Link Settings] is disabled in the System Settings (administrator), the URL can be accessed and the scanned file downloaded during the file save period.
- The scanned file will be saved even if a send data limit is set in the System Settings (administrator) and the file exceeds the limit. The scanned file will be saved as a single file even if [If the E-mail attachment(s) exceed maximum size, it will be sent in multiple files] is enabled in the System Settings (administrator) and the file exceeds the limit. If there is a job other than a Scan to E-mail job in a broadcast transmission and the scanned file exceeds the [Maximum Size of Data Attachments (FTP/Desktop/Network Folder)] setting, transmission will not be possible.



- **To use this function**

Configure in "Settings (administrator)" - [System Settings] - [Image Send Settings] - [Scan Settings] - [Condition Settings] - [Send Destination Link Settings].

- **To always use this function in simple mode**

Configure in "Settings (administrator)" - [System Settings] - [Image Send Settings] - [Scan Settings] - [Condition Settings] - [Send Destination Link Settings] - [Enable Send Destination Link as Default].

When this function is enabled and e-mail is sent in normal mode, the [Send Destination Link] checkbox in the action panel is always .

- **Save period for scanned files saved using this function**

Configure in "Settings (administrator)" - [System Settings] - [Image Send Settings] - [Scan Settings] - [Condition Settings] - [Send Destination Link Settings] - [File Retention Period].

- **Protecting the URL by SSL**

Configure in "Settings (administrator)" - [System Settings] - [Image Send Settings] - [Scan Settings] - [Condition Settings] - [Send Destination Link Settings] - [Enable SSL].



TRANSMITTING AN IMAGE

TRANSMITTING AN IMAGE

SENDING AN IMAGE IN SCAN MODE

An image can be sent in scan mode (Scan to E-mail, Scan to FTP, Scan to Desktop, and Scan to Network Folder).



- If the memory becomes full while the originals are being scanned, a message will appear and scanning will stop.
- When performing Scan to E-mail, take care not to send a file that is too large. In particular, multi-page files tend to be large. When sending a multi-page file or other large file, it may be necessary to reduce the number of scanned pages or reduce the send size.



Do not place any objects under the original size detector. Closing the automatic document feeder with an object underneath may damage the original size detector plate and prevent correct detection of the document size.

1







Place the original.

Place the original in the document feeder tray of the automatic document feeder, or on the document glass.

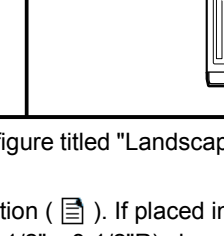

- [AUTOMATIC DOCUMENT FEEDER \(page 1-84\)](#)
- [DOCUMENT GLASS \(page 1-86\)](#)



- When placing the originals, orient them as shown below.

Originals	Document feeder tray Place the original face up.	Document glass Place the original face down and align the corner with the tip of the  mark in the top left corner of the document glass scale.
Portrait orientation* 		
Landscape orientation* 		

*To place a large portrait-oriented original, place it as shown in the figure titled "Landscape orientation" and specify the placement orientation in step 4.

- Place A5 (5-1/2" x 8-1/2") size originals in portrait (vertical) orientation (). If placed in landscape (horizontal) orientation (), an incorrect size will be detected. For an A5R (5-1/2" x 8-1/2"R) size original, enter the original size manually.



2

Specify the destination.

- ▶ [RETRIEVING A DESTINATION FROM AN ADDRESS BOOK \(page 5-16\)](#)
- ▶ [VIEWING A LIST OF THE SELECTED DESTINATIONS \(page 5-19\)](#)
- ▶ [USING A SEARCH NUMBER TO RETRIEVE A DESTINATION \(page 5-20\)](#)
- ▶ [ENTERING AN ADDRESS MANUALLY \(page 5-21\)](#)
- ▶ [SPECIFYING A NETWORK FOLDER \(page 5-22\)](#)
- ▶ [RETRIEVING A DESTINATION FROM A GLOBAL ADDRESS BOOK \(page 5-23\)](#)
- ▶ [USING A TRANSMISSION LOG TO RESEND \(page 5-25\)](#)

The icon on the key indicates the type of destination stored in the key.

- Scan to E-mail
- Scan to FTP
- Scan to Network Folder
- Scan to Desktop



- After a one-touch key is tapped, if the screen is changed without tapping **+**, the destination of the tapped key is automatically specified.
- When performing Scan to E-mail, you can also send Cc or Bcc copies to other destinations. Tap the [Address Review] key to select destinations.
 - ▶ [VIEWING A LIST OF THE SELECTED DESTINATIONS \(page 5-19\)](#)
- Multiple destinations can be specified.
- To change [Subject], [File Name], [Reply-To], or [Body Text] in normal mode, tap a target entry box, or tap [Options].
 - ▶ [CHANGING THE SUBJECT, FILE NAME, REPLY-TO, AND BODY TEXT AT THE TIME OF SCAN TRANSMISSION \(page 5-33\)](#)

3

Tap the [Original] key.

4

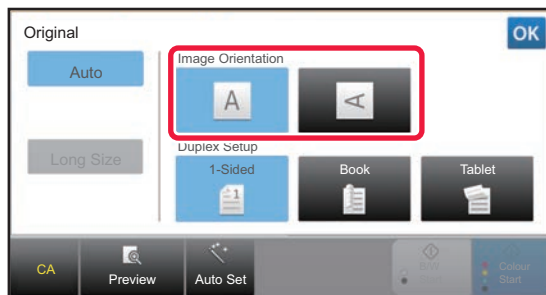
**Tap the appropriate orientation key.**

Specify the orientation of the original placed in step 1. After the settings are completed, tap **OK**.



- You can change exposure, resolution, file format, colour mode, and other settings.
 - ▶ [AUTOMATICALLY SCANNING BOTH SIDES OF AN ORIGINAL \(2-SIDED ORIGINAL\) \(page 5-48\)](#)
 - ▶ [SCAN SIZE AND SEND SIZE \(ENLARGE/REDUCE\) \(page 5-49\)](#)
 - ▶ [CHANGING THE EXPOSURE AND ORIGINAL IMAGE TYPE \(page 5-57\)](#)
 - ▶ [CHANGING THE RESOLUTION \(page 5-59\)](#)
 - ▶ [CHANGING FORMAT IN SCAN OR DATA ENTRY MODE \(page 5-60\)](#)
 - ▶ [CHANGING COLOUR MODE \(page 5-66\)](#)
- Tapping the [Others] key allows you to configure various functions, for example, collectively sending two original pages as one sheet or original pages with different sizes.



5

Tap the [B/W Start] or [Colour Start] key to start scanning of the original.

- If the original was inserted in the document feeder tray, a beep will sound when scanning is completed and transmission will take place.
- If the original is placed on the document glass, the [Read-End] key appears in the touch panel. If the original is only one page, go to step 7. To scan more pages, go to step 6.



- You can tap the [Preview] key to check a preview of the image before sending an image. For more information, see "[CHECKING THE IMAGE TO BE TRANSMITTED \(page 5-68\)](#)".
- If the file format is set to [PDF/Encry.], [PDF/Encry./Bk Letter Emphasis], [PDF/Encry./Compact], or [PDF/Encry./Compact/U-Fine], you will be prompted to enter the password when you tap the [B/W Start] or [Colour Start] key.
Tap the password entry box to open the keyboard screen, enter a password using a maximum of 32 characters, and tap the [OK] and [Send] key in sequence. The recipient must use the password entered here to open the Encrypt PDF file.
To cancel Encrypt PDF, tap the [Cancel] key. The format settings screen will appear to let you change the file type. Select a new file type and tap the [B/W Start] or [Colour Start] key to begin transmission.

6

If the original was placed on the document glass, replace it with the next original and tap the [B/W Start] or [Colour Start] key.

Repeat until all originals have been scanned.

7

Tap the [Read-End] key.

A beep will sound to indicate that the operation is completed.



- If no action is taken for one minute after the confirmation screen is displayed, scanning automatically ends and the transmission is reserved.
- Tap the [Change Setting] key to change the exposure, resolution, scan size, and send size for each original page scanned. However, when "Card Shot" is selected in Others, change only the exposure when scanning an even-numbered original page.
- When Scan to E-mail and Internet Fax destinations are included, the send width for Scan to E-mail and Internet Fax will be the same as the send width for fax.



To change the time until transmission takes place automatically:

Select "Settings (administrator)" - [System Settings] → [Image Send Settings] → [Common Settings] → [Condition Settings] → [Job Auto Start Time During Scanning].



CHANGING THE SUBJECT, FILE NAME, REPLY-TO, AND BODY TEXT AT THE TIME OF SCAN TRANSMISSION

Change the subject, file name, reply-to, and body text when performing a scan transmission. If necessary, directly enter the text.



- When performing Scan to FTP, Scan to Desktop, or Scan to Network Folder, only the file name is used.
- If the subject or file name is not changed, the settings in [System Settings] → [Image Send Settings] → [Scan Settings] → [Administration Settings] in "Settings (administrator)" are used.
- If the reply-to address is not changed, the settings in [System Settings] → [Image Send Settings] → [Scan Settings] → [Condition Settings] → [Default Reply.Address Set] in "Settings (administrator)" are used. If this is not configured, the reply address configured in [Network Settings] → [Services Settings] → [SMTP] → [Sender Address] in the "Settings" is used. (Administrator rights are required.)
- To configure the candidates for the subject, file name, and body text, select [System Settings] → [Image Send Settings] → [Scan Settings] in "Settings (administrator)".
- To enter text, see "[NAMES AND FUNCTIONS OF SOFT KEYBOARD KEYS \(page 1-165\)](#)" in the "BEFORE USING THE MACHINE"

1

Tap the [Detail] key to change to normal mode.

► [Changing mode from each mode \(page 5-10\)](#)

2

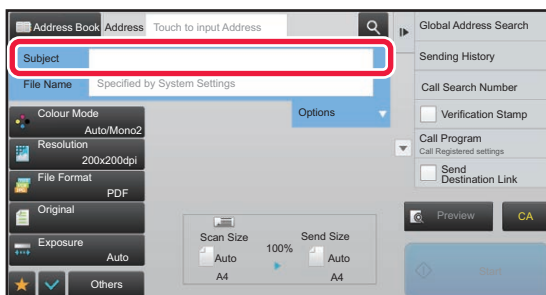

To change the subject, tap the [Subject] entry box.

3

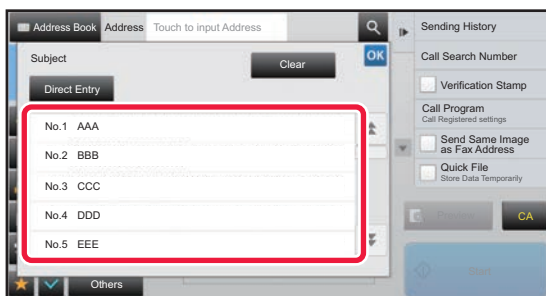

Tap a pre-set text key.

After the settings are completed, tap **OK**.



To cancel the selection of the subject:

Tap the [Clear] key.



If you wish to directly enter the text, tap the [Direct Entry] key to open the soft keyboard.

Enter the text and tap the [OK] key.



4

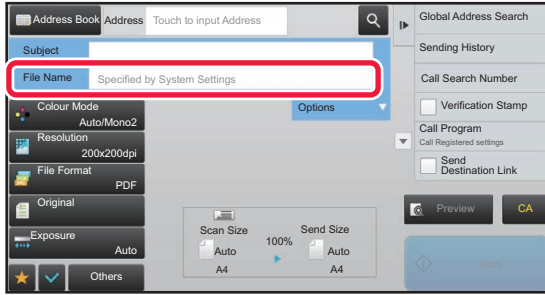

To change the file name, tap the [File Name] entry box.

After the settings are completed, tap **OK**.

- Tap the key of the file name from the list.
- To directly enter the file name, tap the [Direct Entry] key.
- A prompt is displayed in the file name. The prompt is changed according to the settings.

If the settings are not changed, "Following the System Settings" is displayed.

When [File Name Auto Extraction] in [OCR Setting] is enabled on the MX-3060V/MX-3070V/MX-3560V/MX-3570V/MX-4060V/MX-4070V/MX-5070V/MX-6070V, "File Name Auto Extraction" is displayed.



When scanning to a shared folder, if you set a file name that is the same as an existing file name in the shared folder, the file name will be changed to prevent overwriting of the existing file.

5

Tap [Options].

6

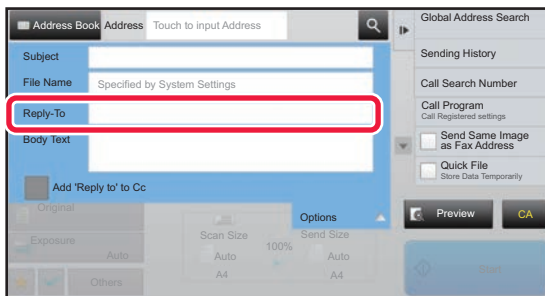

To change the reply address, tap the [Reply-To] entry box.



If user authentication is being used, the information of the user that logged in will be applied, and thus the reply address cannot be changed.

7

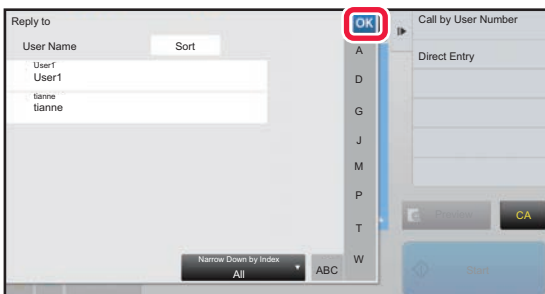

Tap the key that you wish to use for the reply address.

After the settings are completed, tap **OK**.

- You can select addresses from the user list in the same way as you would select the reply address. You can also tap [Global Address Search] on the action panel to specify a user stored in the global address book as the reply address.
- Tapping [Direct Entry] on the action panel allows you to directly enter the e-mail address.
- Selecting the [Add 'Reply to' to Cc] checkbox to adds a reply address to the Cc address.

8

To change the body text, tap the [Body Text] entry box.



9

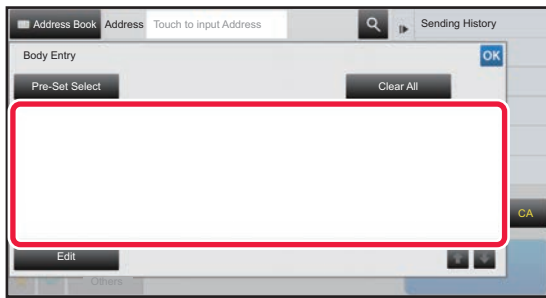

Enter the body text.

After the settings are completed, tap **OK**.

- To select a pre-set text previously stored in the Setting mode (Web version), tap the [Pre-Set Select] key.
- To directly enter the body text, tap the [Edit] key.



To clear all entered text:

Tap the [Clear All] key. When this key is tapped, the entire body of the message is erased immediately, not just the selected line.



- Enter up to 1800 characters. (A line break counts as one character.)
- To edit the selected line, tap the [Edit] key. The soft keyboard will appear with the selected text entered.



SENDING A FAX IN INTERNET FAX MODE

Transmits a fax in Internet Fax mode. This procedure can also be used to perform a direct transmission by Direct SMTP.



- If the memory becomes full while the originals are being scanned, a message will appear and scanning will stop.
- When all originals have been scanned, the message "Job stored." will be displayed together with a job control number. If necessary, use this number to locate the job in the Transaction Report or in the Image Sending Activity Report. If the job is a broadcast transmission, this number will also appear in the key of the job in the job status screen. For this reason, it is advisable to make a note of the number so that you can check the result easily.
- Mail Footer Registration: The specified text is automatically appended to the end of the body text of e-mail. This is convenient when you wish to append pre-set text such as a corporate policy. To enter the text to append, select [System Settings] → [Image Send Settings] → [Scan Settings] → [Administration Settings] → [Mail Footer Registration] in "Settings (administrator)". (Administrator rights are required.)
Enter up to 900 characters. (The appended text is not included in the maximum number of characters that can be entered in the e-mail body.)
To specify whether or not to append text, select [System Settings] → [Image Send Settings] → [Scan Settings] → [Administration Settings] → [Add a Footer Automatically to the Mail Message Body] in "Settings".



If a default address has been configured using "Settings" → [System Settings] → [Image Send Settings] → [Scan Settings] → [Default Address] → [Default Address Setting], the mode cannot be changed, or the destination cannot be changed or added. To switch to Internet fax mode, tap the [Cancel] key in the touch panel and then perform the transmission procedure.

1

Place the original.

Place the original in the document feeder tray of the automatic document feeder, or on the document glass.

- ▶ [AUTOMATIC DOCUMENT FEEDER \(page 1-84\)](#)
- ▶ [DOCUMENT GLASS \(page 1-86\)](#)



Do not place any objects under the original size detector. Closing the automatic document feeder with an object underneath may damage the original size detector plate and prevent correct detection of the document size.



- Place the original of the A5 (5-1/2" x 8-1/2") size in the portrait orientation ().
If placed in landscape orientation (), an incorrect size will be detected.
For an A5R (5-1/2" x 8-1/2"R) size original, enter the original size manually.
▶ [SPECIFYING THE ORIGINAL SCAN SIZE IN PAPER SIZE \(page 5-50\)](#)
- Rotation sending
A4, B5R and A5R (8-1/2" x 11" and 5-1/2" x 8-1/2"R) originals are rotated 90 degrees, and respectively sent in the A4R, B5 and A5 (8-1/2" x 11"R and 5-1/2" x 8-1/2") orientations.
(Rotation sending is not available for originals with A4R, B5, or A5 (8-1/2" x 11"R or 5-1/2" x 8-1/2") size.)

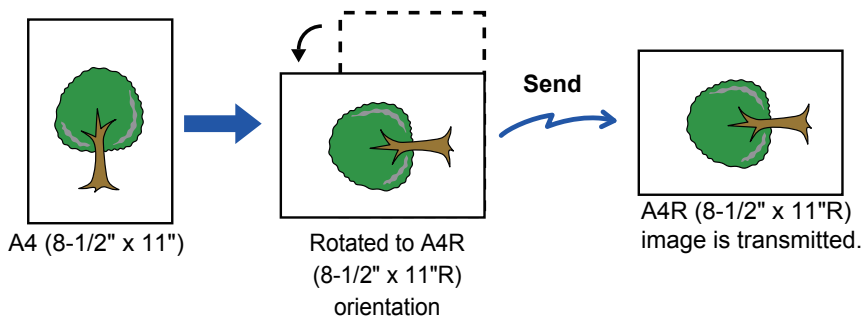

2

Tap the mode display to switch to the initial screen of Internet Fax mode.

- ▶ [SELECTING NETWORK SCANNER MODE \(page 5-9\)](#)



3

Specify the destination.

- ▶ [RETRIEVING A DESTINATION FROM AN ADDRESS BOOK \(page 5-16\)](#)
- ▶ [VIEWING A LIST OF THE SELECTED DESTINATIONS \(page 5-19\)](#)
- ▶ [USING A SEARCH NUMBER TO RETRIEVE A DESTINATION \(page 5-20\)](#)
- ▶ [ENTERING AN ADDRESS MANUALLY \(page 5-21\)](#)
- ▶ [SPECIFYING A NETWORK FOLDER \(page 5-22\)](#)
- ▶ [RETRIEVING A DESTINATION FROM A GLOBAL ADDRESS BOOK \(page 5-23\)](#)
- ▶ [USING A TRANSMISSION LOG TO RESEND \(page 5-25\)](#)

The icon of appears in one-touch keys in which Internet fax addresses are stored.



To change [Subject], [File Name], or [Body Text], tap the [Others] key and tap the [Send Settings] key.

- ▶ [CHANGING THE SUBJECT, FILE NAME, AND BODY TEXT AT THE TIME OF INTERNET FAX TRANSMISSION \(page 5-38\)](#)

4

Tap the [Original] key.



- Set the density, resolution, and format in [System Settings]→[Image Send Settings]→[Internet Fax Settings]→[Default Settings] in "Settings (administrator)".
- Tapping the [Others] key allows you to configure various functions, for example, collectively sending two original pages as one sheet or original pages with different sizes.

5

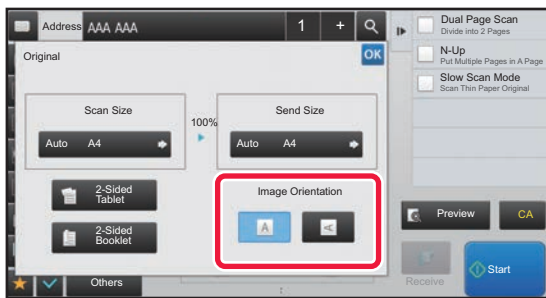

Tap the appropriate orientation key.

After the settings are completed, tap .

6

Tap the [Start] key to start scanning of the original.

- If the original is placed on the document glass, the [Read-End] key appears in the touch panel. If the original is only one page, go to step 8. To scan more pages, go to the next step.
- If the original was inserted in the document feeder tray, a beep will sound when scanning is completed and transmission will take place.



You can tap the [Preview] key to check a preview of the image before sending an image. For more information, see "[CHECKING THE IMAGE TO BE TRANSMITTED \(page 5-68\)](#)".

7

If the original was placed on the document glass, replace it with the next original and tap the [Start] key.

Repeat until all originals have been scanned.



8

Tap the [Read-End] key.

A beep will sound to indicate that the operation is completed.
Open the automatic document feeder and remove the original.



- If no action is taken for one minute after the confirmation screen is displayed, scanning automatically ends and the transmission is reserved.
- Tap the [Change Setting] key to change the exposure, resolution, scan size, and send size for each original page scanned.
However, when "N-Up" or "Card Shot" is selected in Others, only change the exposure when scanning an even-numbered original page.

CHANGING THE SUBJECT, FILE NAME, AND BODY TEXT AT THE TIME OF INTERNET FAX TRANSMISSION

Change the subject, file name, and body text when performing an Internet fax transmission. If necessary, directly enter the text. Configure a file name, and other settings for an Internet fax using the Send Settings of the other functions.



- If the subject and file name are not changed, the settings in the Setting mode (Web version) are used.
- To configure the candidates for the subject, file name, and body text, click [System Settings] → [Image Send Settings] → [Scan Settings] in "Settings (administrator)".
- To enter text, see "[NAMES AND FUNCTIONS OF SOFT KEYBOARD KEYS \(page 1-165\)](#)" in the "BEFORE USING THE MACHINE".

1

Tap the mode display to switch to the initial screen of Internet Fax mode.

► [SELECTING NETWORK SCANNER MODE \(page 5-9\)](#)

2

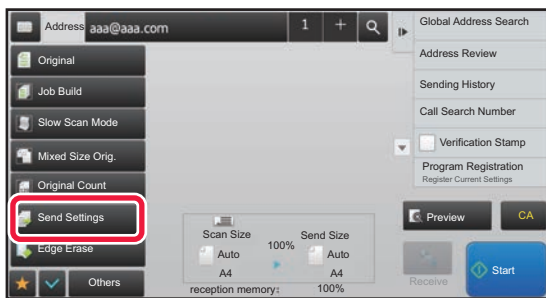
**Tap the [Send Settings] key.**

3

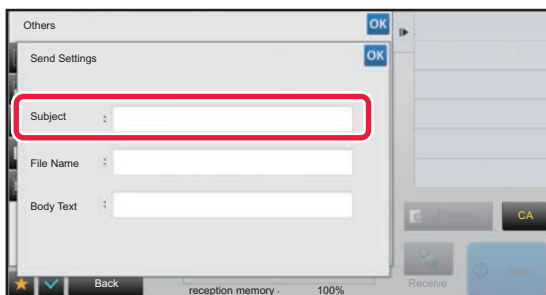
**To change the subject, tap the [Subject] entry box.**



4

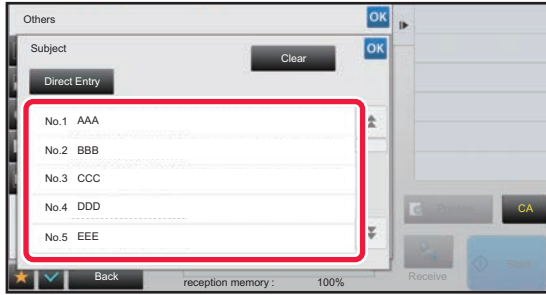

Tap a pre-set text key.



To cancel the selection of the subject:
Tap the [Clear] key.



If you wish to directly enter the text, tap the [Direct Entry] key to open the soft keyboard. Enter the subject and tap the [OK] key.

5

To change the file name, tap the [File Name] entry box.

6

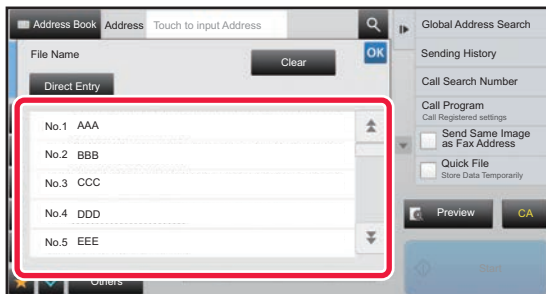

Tap a pre-set text key.

After the settings are completed, tap [OK].



- To store the pre-set text for the file name, select [System Settings] in "Settings" → [Image Send Settings] → [Scan Settings] → [File Name Settings].
- If you wish to directly enter the text, tap the [Direct Entry] key to display the soft keyboard. Enter the file name and tap the [OK] key.



To cancel the selection of the file name:
Tap the [Clear] key.

7

To change the body text, tap the [Body Text] entry box.



8

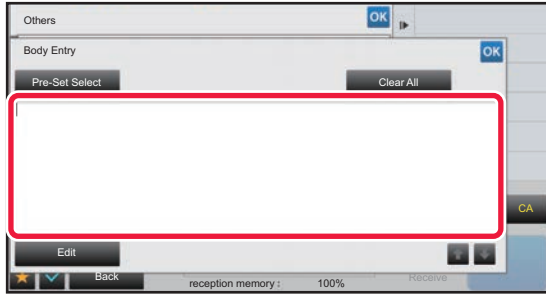

Enter the body text.

After the settings are completed, tap **OK**.

- To select a pre-set text previously stored in the Setting mode (Web version), tap the [Pre-Set Select] key.
- To directly enter the body text, tap the [Edit] key.



To clear all entered text:

Tap the [Clear All] key. When this key is tapped, the entire body of the message is erased immediately, not just the selected line.



- Enter up to 1800 characters. (A line break counts as one character.)

Use **↑** **↓** to select on a line basis.

- To edit the selected line, tap the [Edit] key. The soft keyboard will appear with the selected text entered.



SENDING THE SAME IMAGE TO MULTIPLE DESTINATIONS (BROADCAST TRANSMISSION)

Send the same scanned image to multiple scan, Internet fax, and fax mode destinations in a single operation. One operation allows you to send data to up to 500 destinations, including the reserved send jobs. (For example, if broadcast transmission jobs with 450 destinations are already reserved, data can be broadcasted to up to 50 destinations.)

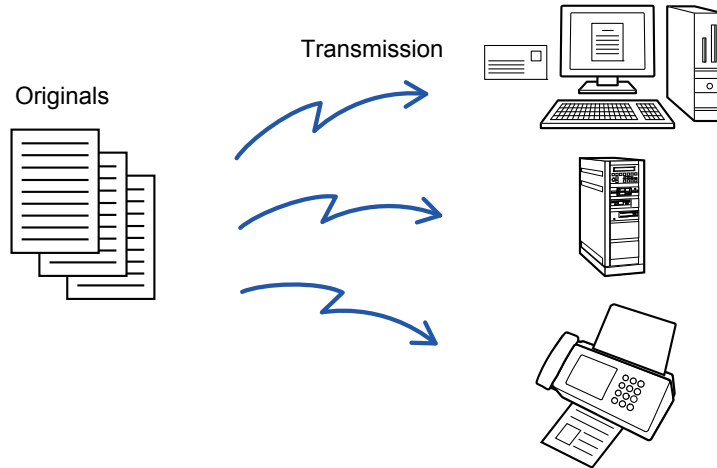

It is convenient to store destinations you frequently use for broadcast transmission as contacts or groups. A maximum of 500 destinations can be stored in one contact.

For broadcast transmission, the contact or group key can be simply tapped to retrieve multiple fax numbers.

You can also send faxes with the one-touch key by setting the [Set as Default used] checkbox to when addresses are registered. If you wish to temporarily remove a destination from the stored addresses, open the detail confirmation screen and remove the destination in the screen.

- ▶ [STORING ADDRESSES THROUGH DIRECT ENTRY \(page 1-102\)](#)
- ▶ [STORING ADDRESSES THROUGH GLOBAL ADDRESS SEARCH \(page 1-103\)](#)
- ▶ [USING A TRANSMISSION LOG TO RESEND \(page 5-25\)](#)
- ▶ [STORING GROUPS \(page 1-106\)](#)



- When the checkbox of "Settings (administrator)" -[System Settings] → [Image Send Settings] → [Common Settings] → [Condition Settings] → [Address Book Default Selection] → [Apply Addresses of Sending Modes Only] is set to (factory default setting), the image is only sent to those destinations among the destinations that are set to [Set as Default used] which are for the currently selected mode. If the checkmark is removed , the image can also be sent to destinations of other modes.
- When broadcast transmission includes Internet Fax addresses, the document is sent in black and white to all addresses.
- When Internet Fax mode addresses are included in broadcast transmission addresses, the image data is converted and sent as image data for Internet Fax. Even when scanned in colour, the image data is converted to Internet Fax black and white binary and sent to addresses such as e-mail addresses.
- If you wish to send the same image as fax to all destinations in normal mode, tap [Send Same Image as Fax Address] on the action panel. This cannot be selected when Internet Fax is included in the destinations.
- When Scan to E-mail and Internet Fax destinations are included, the send width for Scan to E-mail and Internet Fax will be the same as the send width for fax.
- Broadcast transmission is not possible to both direct SMTP addresses and other types of addresses.



A transmission is performed, ignoring hyperlinks with Scan to FTP and Scan to Network Folder addresses.



To register destinations in a contact or group:

In the address book screen, tap [Add New] on the action panel, or tap the [Address Control] icon in the home screen. For more information, see "[STORING ADDRESSES THROUGH DIRECT ENTRY \(page 1-102\)](#)", "[STORING ADDRESSES THROUGH GLOBAL ADDRESS SEARCH \(page 1-103\)](#)", "[USING A TRANSMISSION LOG TO RESEND \(page 5-25\)](#)", or "[STORING GROUPS \(page 1-106\)](#)".



1

Place the original.

Place the original in the document feeder tray of the automatic document feeder, or on the document glass.

- ▶ [AUTOMATIC DOCUMENT FEEDER \(page 1-84\)](#)
- ▶ [DOCUMENT GLASS \(page 1-86\)](#)

2

Specify all destinations.

- ▶ [RETRIEVING A DESTINATION FROM AN ADDRESS BOOK \(page 5-16\)](#)
- ▶ [VIEWING A LIST OF THE SELECTED DESTINATIONS \(page 5-19\)](#)
- ▶ [USING A SEARCH NUMBER TO RETRIEVE A DESTINATION \(page 5-20\)](#)
- ▶ [ENTERING AN ADDRESS MANUALLY \(page 5-21\)](#)
- ▶ [SPECIFYING A NETWORK FOLDER \(page 5-22\)](#)
- ▶ [RETRIEVING A DESTINATION FROM A GLOBAL ADDRESS BOOK \(page 5-23\)](#)
- ▶ [USING A TRANSMISSION LOG TO RESEND \(page 5-25\)](#)



- One-touch keys that cannot be used for broadcast transmission are greyed out to prevent selection.
- If a Scan to FTP or Network Folder address is specified in a broadcast transmission, hyperlink e-mail transmission will not take place.



- If [System Settings] → [Image Send Settings] → [Common Settings] → [Condition Settings] → [Be sure to press Next Address Key ([+]) before selecting the next address.] is enabled in "Settings (administrator)", tap **+** before specifying the next destination.
- If you wish to send the same image (Mono2) as the one for the fax address to all destinations in normal mode, tap [Send Same Image as Fax Address] on the action panel.

3

Tap [Address Review] on the action panel.

4

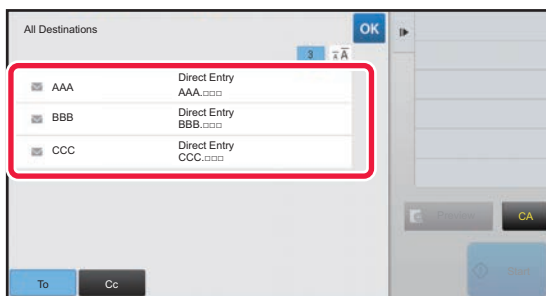

Confirm the destination.



- **To cancel a specified destination:**
Tap the key of the destination that you wish to cancel to release the selection.
- **To switch delivery types (To/Cc/Bcc):**
Tap the address that you want to change, and tap [Change to To], [Change to Cc], or [Change to Bcc] on the action panel.



5

Tap the [B/W Start] or [Colour Start] key ([Start] key in normal mode) to start scanning of the original.

- If you inserted the original pages in the document feeder tray, all pages are scanned. A beep will sound to indicate that scanning and transmission have ended.
- When you place the original on the document glass, scan each page at a time. When scanning finishes, place the next original and tap the [B/W Start] or [Colour Start] key ([Start] key in normal mode). Repeat until all pages have been scanned and then tap the [Read-End] key. A beep will sound to indicate that transmission has ended.



You can tap the [Preview] key to check a preview of the image before sending an image. For more information, see "[CHECKING THE IMAGE TO BE TRANSMITTED \(page 5-68\)](#)".

SETTING MODES WHEN MULTIPLE TYPES OF ADDRESSES ARE INCLUDED IN A BROADCAST TRANSMISSION

This section explains settings you should bear in mind if multiple types of addresses are included in a broadcast transmission.

When a broadcast transmission includes a mix of several types of addresses (such as scan mode and Internet Fax mode destinations), its settings are enabled for all addresses regardless of which mode screen is used to configure them. Note the following exceptions:

When Internet Fax addresses are not include

File format (file compression mode)	The compression mode set with [System Settings] → [Image Send Settings] → [Scan Settings] → [Condition Settings] → [Compression Mode at Broadcasting] in "Settings (administrator)" is used for all destinations.
Colour Mode	When the colour mode setting is [Full Colour] in scan mode, the image will be sent in Mono2 to fax addresses and in colour to scan addresses. To send the image in Mono2 to all addresses, tap [Send Same Image as Fax Address] on the action panel in normal mode
Original Count	An address of a mode in which the number of original sheets are specified, if it exists, is enabled.
Scan file size	If a broadcast transmission is performed that includes destinations for which an attachment size limit has been set using [Maximum Size of E-mail Attachments] or [Maximum Size of Data Attachments (FTP/Desktop/Network Folder)] (in "Settings (administrator)", select [System Settings] → [Image Send Settings] → [Scan Settings] → [Condition Settings]), the limit will also apply to destinations for which a limit is not set.
N-Up	This mode is available only for Fax. It is linked to a mode with an appropriate function.
Drop Out colour	This mode is available for Scanner and Data entry. It is linked to a mode with an appropriate function.
RGB	This mode is available for Scanner, Network Folder, and FTP/Desktop. It is linked to a mode with an appropriate function.



When Internet Fax addresses are included

When Internet Fax addresses are included in the destinations, the following restrictions apply.

Colour Mode	Fixed at black & white binary.
File format (file compression mode)	Fixed at TIFF.
Original	Transmission will take place to all addresses using the same image width as Internet Fax.
Background Adjustment	Cannot be set.
Blank Page Skip	
Drop Out colour	
Contrast	
Sharpness	
RGB	
Sign	
Encrypt	
Multicrop	
Business Card Scan	
Image Crop	



Broadcast transmission is not possible to both direct SMTP addresses and other types of addresses.



RESENDING TO UNSUCCESSFUL BROADCAST TRANSMISSION DESTINATIONS

The results of a completed broadcast transmission can be checked in the job status screen. If transmission to any of the destinations failed, resend the image to those destinations.

1 Tap the job status display.

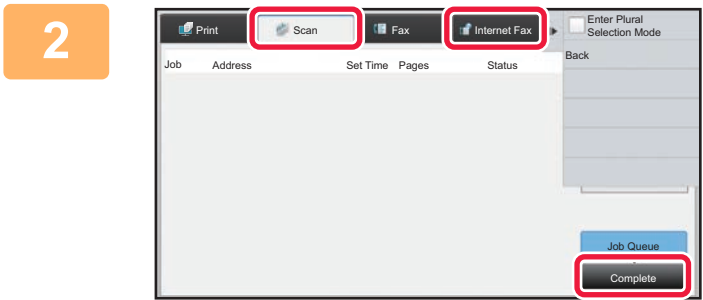

Tap the [Scan] tab or [Internet Fax] tab, and tap the [Complete] key.



If the broadcast transmission included destinations of different modes, the same broadcast transmission key will appear in each of those modes.

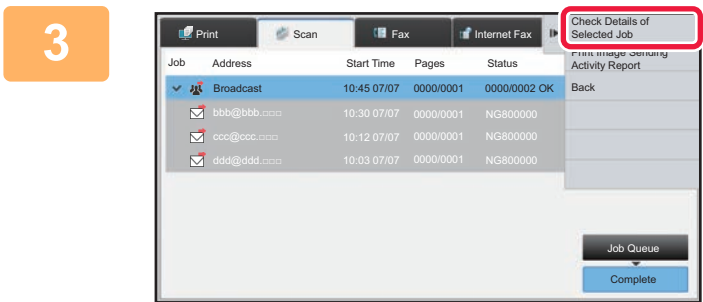

After tapping the key of the completed broadcast transmission, tap [Check Details of Selected Job] on the action panel.



4

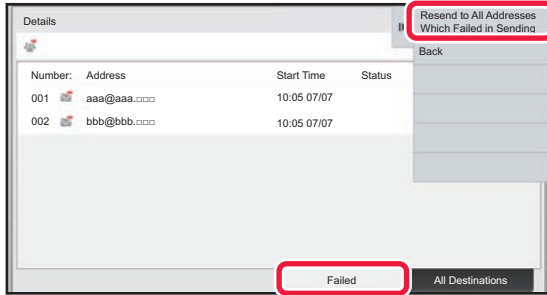

After tapping the [Failed] tab, tap [Resend to All Addresses Which Failed in Sending] on the action panel to resend the image.



The steps to follow after [Resend to All Addresses Which Failed in Sending] is tapped differ depending on whether or not document filing is used.

• **Using document filing:**

You will return to the document filing resend screen with the unsuccessful destinations entered.

Perform the document filing resend procedure. (There is no need to re-scan the original.)

• **Not using document filing:**

You will return to the base screen with the unsuccessful destinations entered. Place the original and perform the steps of the broadcast transmission.



SENDING AN INTERNET FAX FROM A PC (PC-I-FAX)

A file on a computer can be sent via the machine as a fax (PC-I Fax function).

Faxes are sent using the PC-I Fax function in the same way that documents are printed. Select the PC-Fax driver as the printer driver for your computer and then select the Print command in the application. Image data for transmission will be created and sent as an Internet fax.

By using the "Log Viewer" application, Internet faxes can be sent using the transmission log displayed in the Log Viewer. For the procedures for using this function, see the PC-Fax driver Help.

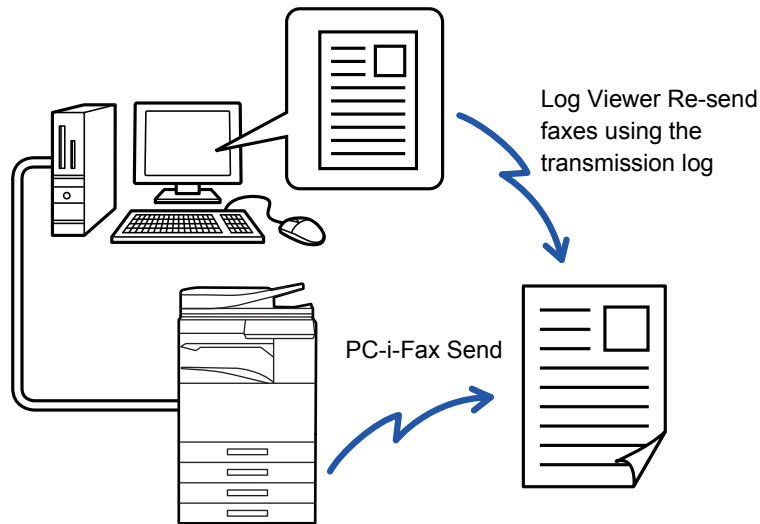

- To send an Internet fax using the PC-I-Fax function, the PC-Fax driver must be installed and then updated using the CD-ROM that accompanies the Internet fax expansion kit. For more information, see the Software Setup Guide.
- This function can only be used on a Windows computer.



This function is available for transmission. Internet faxes received on the machine cannot be received to a computer that is connected to the machine.



IMAGE SETTINGS

AUTOMATICALLY SCANNING BOTH SIDES OF AN ORIGINAL (2-SIDED ORIGINAL)

The automatic document feeder is used to automatically scan both sides of an original.

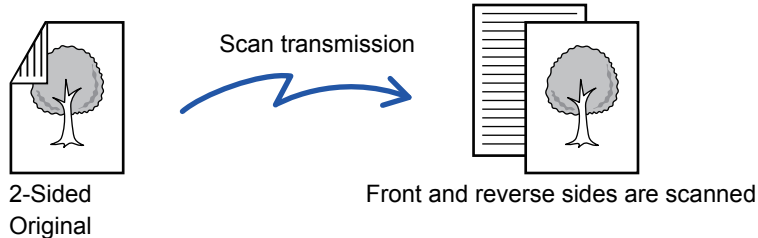

The settings on 2-sided scanning are cleared when transmission has completed.



- You cannot use 2-Sided scanning when the original size is set to Long Size.
- On the MX-2630N/MX-3050V/MX-3060V/MX-3550V/MX-3560V/MX-4050V/MX-4060V/MX-5050V/MX-6050V, duplex scanning is not possible when originals of mixed width are scanned.

1

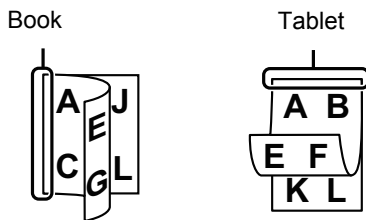

After tapping the [Original] key, tap the [Book] or [Tablet] key.

See the figure on the left to check the binding edge of the original and select the key to be tapped.



In normal mode, tap the [2-Sided Tablet] or [2-Sided Book] key.

2

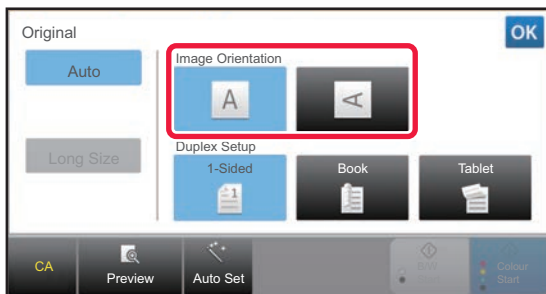

Tap the [Image Orientation] key with the same orientation as the placed original.

If this setting is not correct, a suitable image may not be transmitted.

After the settings are completed, tap **OK**.



To cancel 2-sided scanning:

Tap the [1-Sided] key.

In normal mode, tap the [2-Sided Tablet] key or the [2-Sided Book] key that has been forcibly displayed and cancel the display.



SCAN SIZE AND SEND SIZE (ENLARGE/REDUCE)

When the original is placed, its size is automatically detected.

In normal mode, the size of the placed original is indicated as the "Scan Size", and the size to be transmitted is indicated as the "Send Size".

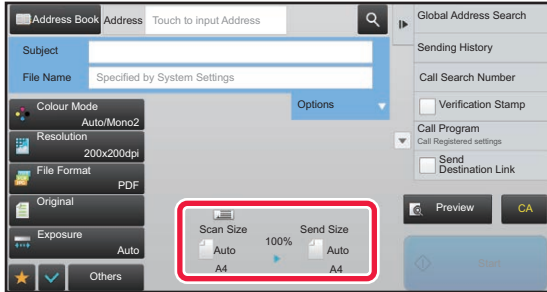

In the above screen, the scan size (the placed original) is A4 (8-1/2" x 11") and the send size is auto. For example, if the scan size is A4 (8-1/2" x 11") and the send size is B5 (5-1/2" x 8-1/2"), the image will be reduced before transmission.

Scan Size

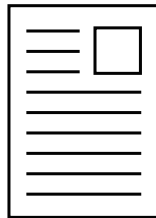

A4

"Send Size" is set to B5 (5-1/2" x 8-1/2")

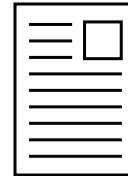

The image is reduced to B5 (5-1/2" x 8-1/2") before transmission



- Only standard original sizes can be automatically detected.
 - ▶ [THE SIZE OF THE PLACED ORIGINAL \(page 5-14\)](#)
- When the original size is an inch size or a non-standard size, or if the size is not detected correctly, manually specify the original scan size.
 - ▶ [SPECIFYING THE ORIGINAL SCAN SIZE IN PAPER SIZE \(page 5-50\)](#)
 - ▶ [SPECIFYING THE ORIGINAL SCAN SIZE USING NUMERIC VALUES \(page 5-51\)](#)



SPECIFYING THE ORIGINAL SCAN SIZE IN PAPER SIZE

When the original size is a non-standard size or is not detected correctly, manually specify the original size.



When [Long Size] is selected, the 2-sided scanning setting and send size cannot be changed. The image is sent in Mono2 only.

1

Tap the [Detail] key to change to normal mode.

► [Changing mode from each mode \(page 5-10\)](#)

2

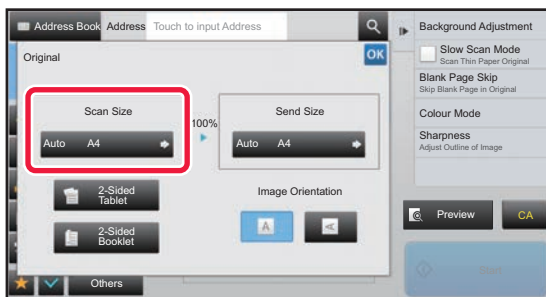

After tapping the [Original] key, tap the [Scan Size] key.

3

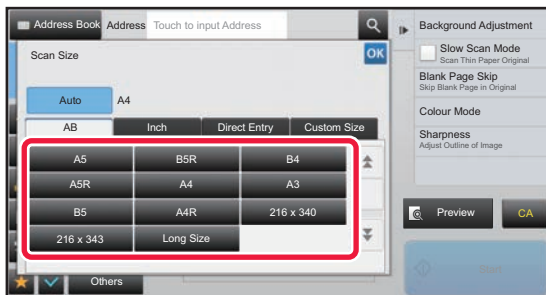

Tap the appropriate original size key.

After the settings are completed, tap **OK**.



If you are sending a long original, tap the [Long Size] key.

Use the automatic document feeder to scan a long original. The maximum width that can be scanned is 1,000 mm (39-3/8") (the maximum height is 297 mm (11-5/8")).

► [TRANSMITTABLE ORIGINAL SIZES \(page 5-14\)](#)



SPECIFYING THE ORIGINAL SCAN SIZE USING NUMERIC VALUES

When scanning a non-standard size original such as a card or postcard, specify the original size using numeric values after placing the original.

The width can be from 25 mm to 432 mm (1" to 17"), and the height can be from 25 mm to 297 mm (1" to 11-5/8").



When the scan size is specified by numeric values, the send size cannot be specified.

1

Tap the [Detail] key to change to normal mode.

► [Changing mode from each mode \(page 5-10\)](#)

2

Tap the [Original] key.

3

After tapping the "Scan Size" key, tap the [Direct Entry] key.

4

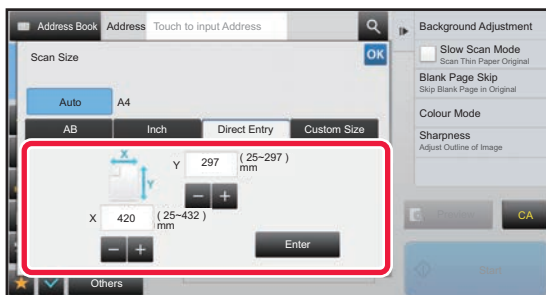

Specify the original size.



- Tap the areas displaying width and height sizes respectively, and enter the sizes using the numeric keys.
- It is convenient to use **- +** to finely adjust the entered size.

5

Tap the [OK] key.

After the settings are completed, tap **OK** twice.

On the base screen, check that the specified size is displayed on the [Original] key.



To cancel the specified size settings:

Tap the [Auto] key.



STORING FREQUENTLY USED ORIGINAL SIZES

Store the frequently used non-standard original sizes. This section explains how to store, retrieve, change, and delete non-standard original sizes.



- The stored original size will be retained even if the main power is turned off.
- A total of up to 12 non-standard original sizes can be registered for copying, fax, and image sending.
- The added original sizes will also appear in other modes.

Storing original sizes (Amend/Delete)

1

Tap the [Detail] key to change to normal mode.

▶ [Changing mode from each mode \(page 5-10\)](#)

2

Tap the [Original] key.

3

Tap the [Scan Size] key and tap the [Custom Size] tab.

4

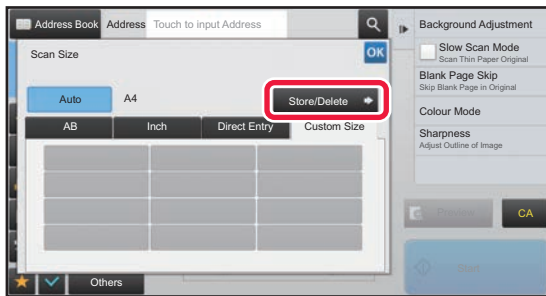

Tap [Store/Delete] key.



5

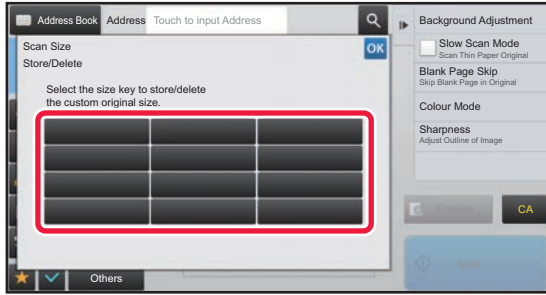

Tap a key () for storing a custom original size.

Tap a key that does not show a size.



To amend or delete a previously stored key:

Tap the key that you want to amend or delete. The following screen will appear.

- To amend the key, tap the [Amend] key and go to the next step.
- To delete the key, tap the [Delete] key. Make sure that the original size has been cleared and tap the [OK] key.

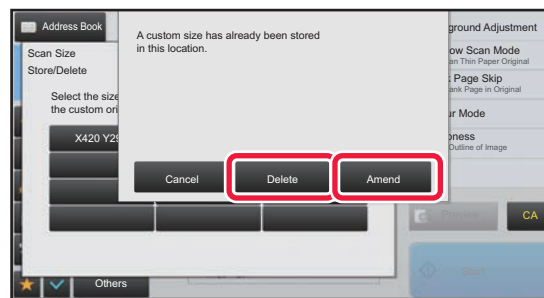

6



Specify the original size.

Tap the areas displaying width and height sizes respectively, and enter the sizes using the numeric keys.



It is convenient to use - + to finely adjust the entered size.

7

Tap the [OK] key.

Tap the [OK] key, and check that the key of the size stored on the Scan Size screen is added properly. After you have checked it, tap [OK].



To cancel the operation:

Tap the [CA] key.



Retrieving a stored original size

1

Tap the [Detail] key to change to normal mode.

▶ [Changing mode from each mode \(page 5-10\)](#)

2

Tap the [Original] key.

3

Tap the [Scan Size] key and tap the [Custom Size] tab.

4

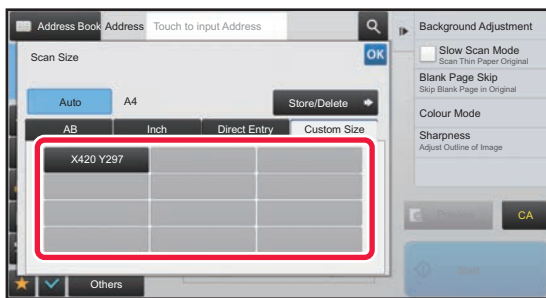

Tap the key of the original size that you wish to retrieve.

After selecting the key of the original size, tap the **OK** key.
Check that the specified size is displayed on the Scan Size screen.



To cancel the operation

Tap the [CA] key.



SPECIFYING THE SEND SIZE OF THE IMAGE

Tap this key to specify the send size as a paper size. If the specified send size is larger than the scan size, the image will be enlarged. If the specified send size is smaller than the scan size, the image will be reduced.



- The send size cannot be specified when [Long Size] is selected for the scan size, or when the scan size is specified by numeric values.
- The send size cannot be specified when [TIFF-S] is selected for the format in Internet fax mode. (The send size is fixed at A4R (8-1/2" x 11"R).)

1

Tap the [Detail] key to change to normal mode.

▶ [Changing mode from each mode \(page 5-10\)](#)

2

Tap the [Original] key.

3

Tap the [Send Size] key.

4

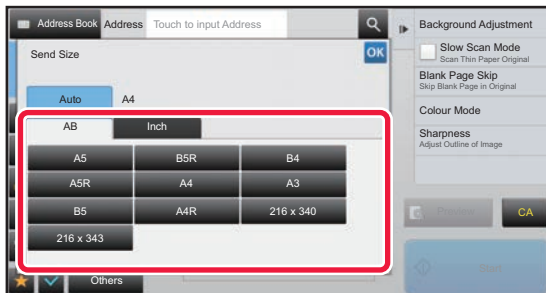

Tap the desired send size key.

After the settings are completed, tap **OK**.



Depending on the paper size specified for the "Scan Size", it may not be possible to select some sizes for the "Send Size". You cannot tap size keys that are unavailable for the "Send Size".



5

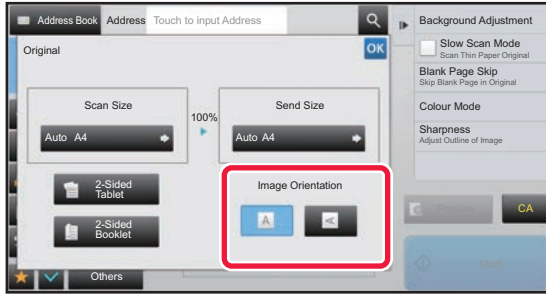

Tap the [Image Orientation] key with the same orientation as the original image.

If this setting is not correct, a suitable image may not be transmitted. After the settings are completed, tap **OK**.



To configure the default setting of image orientation, select [System Settings] → [Image Send Settings] → [Common Settings] → [Condition Settings] → [Image Orientation] in "Settings (administrator)".



The ratio used for reduction or enlargement of the original will appear between the "Scan Size" and the "Send Size".



CHANGING THE EXPOSURE AND ORIGINAL IMAGE TYPE

Optimum scanning is ensured by selecting exposure and original image type based on the original.



- When using the document glass to scan multiple original pages, change the exposure setting each time you change pages.
- The contrast for Internet Fax mode is set in the system settings.
► [Internet Fax Settings \(page 7-102\)](#)



When using the automatic document feeder, the exposure setting cannot be changed once scanning has begun. (If "Job Build" is used in Others, change the exposure each time a new set of originals is inserted.)

Exposure settings

Exposure		Suggestion
Auto		This setting automatically adjusts the exposure for light and dark parts of the original.
Manual	1-2	Select this setting when the original consists of dark text.
	3	Select this setting for a normal original (neither dark nor light).
	4-5	Select this setting when the original consists of light text.

How to select the original type (Scan mode, Data entry mode)

Setup Items		Description
Auto		The original image type is automatically selected to match the original.
Manual	Text/Printed Photo	This mode provides the best balance for scanning an original which contains both text and printed photographs, such as a magazine or catalogue.
	Text/Photo	This mode provides the best balance for scanning an original which contains both text and photographs, such as a text document with a photo pasted on.
	Text	Use this mode for regular text documents.
	Photo	Use this mode to scan photos.
	Printed Photo	This mode is best for scanning printed photographs, such as photos in a magazine or catalogue.
	Map	This mode is best for copying maps with light colour shading and fine text.



In Scan mode or Data entry mode

1

Tap the [Detail] key to change to normal mode.

► [Changing mode from each mode \(page 5-10\)](#)

2

Tap the [Exposure] key.

3

Tap the key assigned to the original type you wish to set based on the original type.

4

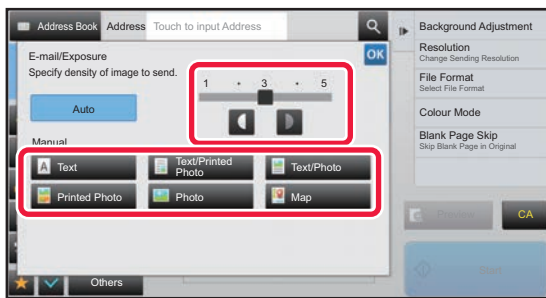

Tap   to adjust the exposure.

After the settings are completed, tap .



When [Auto] is selected, changing the exposure sets the original image type to [Text/Printed Photo] automatically.



CHANGING THE RESOLUTION

Specify the resolution setting.

How to select the resolution

For normal text originals, 200 x 200 dpi produces an image that is sufficiently legible.

For photos and illustrations, a high resolution setting (600 x 600 dpi, etc.) will produce a sharp image.

However, a high resolution setting will result in a large file, and if the file is too large, transmission may not be possible. In this event, reduce the number of pages scanned or take other measures to decrease the file size.

- ▶ [CHANGING FORMAT IN SCAN OR DATA ENTRY MODE \(page 5-60\)](#)
- ▶ [CHANGING FORMAT IN INTERNET FAX MODE \(page 5-66\)](#)
- ▶ [SPECIFYING THE SEND SIZE OF THE IMAGE \(page 5-55\)](#)



When using the automatic document feeder, the resolution setting cannot be changed after scanning has begun. (However, when "Job Build" is used in Others, change the resolution each time a new set of originals is inserted.)



- When using the document glass to scan multiple original pages, change the resolution setting each time you change pages.
- The resolution for Internet Fax mode is set in the system settings.
 - ▶ [Internet Fax Settings \(page 7-102\)](#)

1

Tap the [Detail] key to change to normal mode.

- ▶ [Changing mode from each mode \(page 5-10\)](#)

2

Tap the [Resolution] key.

3

Tap the key of the desired resolution.

After the settings are completed, tap **OK**.

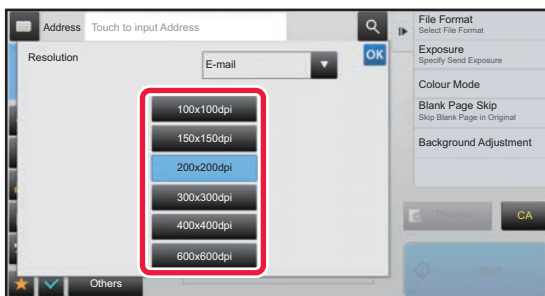

- This cannot be selected when Internet Fax addresses are included.
- If there is a mix of destinations in different modes, tap ▼ to switch modes to set the resolution in each mode. However, FTP/Desktop and Network Folder are set to the same mode.
- If you set the file format to [Compact PDF] in [Format], or the compression ratio to [Bk Letter Emphasis], the resolution is set to [300x300dpi].



CHANGING FORMAT IN SCAN OR DATA ENTRY MODE

Change the file format (file type and compression mode/compression ratio) for sending a scanned image at the time of transmission. In addition, if the scanned originals are divided into separate files, the number of pages per file can be changed.



The file type of [B/W] mode and the file type of [Colour/Greyscale] mode are linked. The file type cannot be set separately for each. (When [JPEG] is selected for [Colour/Greyscale] mode, [TIFF] is automatically selected for [B/W] mode.)

File format combinations

[Colour/Greyscale] tab	[B/W] tab
PDF*1	PDF*1
Compact PDF*1, 2	PDF*1
Compact PDF (Ultra Fine)*1, 2	PDF*1
PDF/A-1a*1, 4	PDF/A-1a*1, 4
PDF/A-1b*1, 4	PDF/A-1b*1, 4
PDF/A*1, 7	PDF/A*1, 7
Compact PDF/A-1a*1, 3, 4	PDF/A-1a*1, 4
Compact PDF/A-1b*1, 3, 4	PDF/A-1b*1, 4
Compact PDF/A*1, 5, 6	PDF/A*1, 5
Compact PDF/A-1a (Ultra Fine)*1, 3, 4	PDF/A-1a*1, 4
Compact PDF/A-1b (Ultra Fine)*1, 3, 4	PDF/A-1b*1, 4
Compact PDF/A (Ultra Fine)*1, 5, 6	PDF/A*1, 5
Encrypt PDF*1	Encrypt PDF*1
Encrypt/Compact PDF*1, 2, 3	Encrypt PDF*1
Encrypt/Compact PDF (Ultra Fine)*1, 2, 3	Encrypt PDF*1
TIFF	TIFF
JPEG	TIFF
XPS	XPS
TXT(UTF-8)*4	TXT(UTF-8)*4
RTF*4	RTF*4
DOCX*4	DOCX*4
XLSX*4	XLSX*4
PPTX*4	PPTX*4

- *1 When PDF (including encrypted and high compression) is selected for the file format, Flate Compression can be used to reduce the file size.
- *2 On the MX-3050V/MX-3550V/MX-4050V/MX-5050V/MX-6050V, this only appears when the Enhanced compression kit is installed. This item cannot be used in MX-2630N.
- *3 Flate Compression can be used with all models. When using the high compression PDF that is provided standard on the MX-3060V/MX-3070V/MX-3560V/MX-3570V/MX-4060V/MX-4070V/MX-5070V/MX-6070V, data is always compressed by Flate Compression, regardless of whether Flate Compression is enabled or disabled in the system settings.
- *4 Only appears on the MX-3060V/MX-3070V/MX-3560V/MX-3570V/MX-4060V/MX-4070V/MX-5070V/MX-6070V
- *5 Only appears on the MX-3050V/MX-3550V/MX-4050V/MX-5050V/MX-6050V
- *6 Only appears when the Enhanced compression kit is installed. This item cannot be used in MX-2630N.
- *7 Only appears on the MX-2630N/MX-3050V/MX-3550V/MX-4050V/MX-5050V/MX-6050V



- The file format for sending a scanned image is specified when the destination is stored in a one-touch key; however, you can change the format at the time of transmission.
- If [PDF/Encry.] is specified for the file format, the password entry screen appears when scanning. Enter a password with up to 32 characters.



Note the following when [PDF/High] is specified in the [Colour/Greyscale] file format.

- When broadcasting to an address with [PDF/High] specified, all files for the scanner will be sent as Compact PDF files.
 - When broadcasting to an address with [PDF/High] and [PDF/Compact/U-Fine] specified, all files for the scanner will be sent as Compact PDF (Ultra Fine) files.
 - If [Compact/PDF] is specified, the resolution cannot be changed in the scanner mode. The resolution is set to 300 x 300 dpi.
 - If [PDF/High] is set when a resolution setting has been specified in scanner (or other) mode, the resolution setting will be cancelled and the Compact PDF resolution will be used for transmission.
 - When [PDF/High] is selected, [Resolution] cannot be changed while waiting for the next original or in [Change Setting] in the job build settings.
 - If [PDF/High] is set when an original type setting has been specified in scanner (or other) mode, [Photo] will change to [Text/Photo] and [Map] will change to [Text/Printed Photo].
 - The condition of the original may prevent the OCR function from correctly recognizing some characters and graphics, and omissions or incorrect recognition of characters may result.*
 - The OCR function is not guaranteed to completely reproduce all characters, graphics, or other contents of a scanned original.*
- * MX-3060V/MX-3070V/MX-3560V/MX-3570V/MX-4060V/MX-4070V/MX-5070V/MX-6070V only

Flate Compression

After compressing a PDF file by JPEG compression, this function compresses the file by lossless compression to further reduce the file size by a small amount. When the data contains significant solid colour, this increases the effectiveness of compression.

When sending a PDF file, Flate Compression enables greater reduction of the file size than conventional methods. If the recipient's PDF viewer does not support Flate Compression, the recipient may not be able to view the PDF file. In this case, Flate Compression can be disabled.



To enable Flate Compression

Enable or disable Flate Compression in [System Settings] → [Image Send Settings] → [Scan Settings] → [Condition Settings] → [PDF Compression Options] in "Settings (administrator)".

1

Tap the [File Format] key.

If you are in data input mode, start from step 5.

2

Tap the [Colour/Greyscale] or [B/W] key.



- The format setting for [B/W] mode is the file format with the [B/W Start] key is tapped.
- The format setting for [Colour/Greyscale] mode is the file format with the [Colour Start] key is tapped.
- When [Colour/Greyscale] mode is selected and the enhanced compression kit is installed, the [Compact] and [U-Fine] checkboxes appear. To suppress image quality deterioration and reduce the data size of a file to be transmitted, select Compact PDF. Select [U-Fine] only when you select Compact PDF. When using the MX-2630N, Compact PDF cannot be selected because the enhanced compression kit cannot be installed.



3

Tap the key of the desired file type.

After the settings are completed, tap **OK**.

MX-2630N/3050V/MX-3550V/MX-4050V/MX-5050V/MX-6050V

When the [B/W] key is selected



When the [Colour/Greyscale] key is selected



MX-3060V/MX-3070V/MX-3560V/MX-3570V/MX-4060V/MX-4070V/MX-5070V/MX-6070V

When the [B/W] key is selected



When the [Colour/Greyscale] key is selected



4

(Only when [PDF] is selected on the MX-3060V/MX-3070V/MX-3560V/MX-3570V/MX-4060V/MX-4070V/MX-5070V/MX-6070V) To enable OCR, select the [OCR] checkbox () and tap [OCR Setting].

After the settings are completed, tap (**OK**).

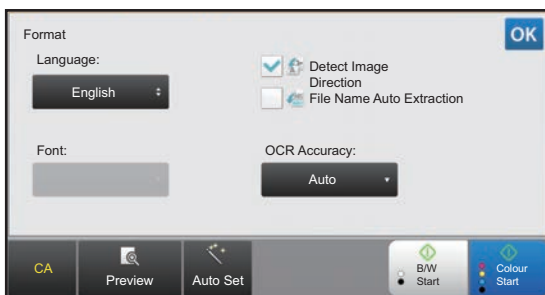



- When "Long Size" is selected for the original, [OCR] cannot be used.
- Select the scanning language in the language settings. The following languages can be selected. Japanese, English, Spanish, French, German, Italian, Dutch, Swedish, Norwegian, Finnish, Danish, Hungarian, Czech, Polish, Russian, Greek, Portuguese, Turkish, Slovak, Catalan, Simplified Chinese, Traditional Chinese, Korean.
- When [RTF], [DOCX], [XLSX], or [PPTX] is selected for the file format, you can set the font of the output text.
- When the [Detect Image Direction] checkbox is selected () , the orientation of the original is detected and the image is rotated before transmission.
- When the [File Name Auto Extraction] checkbox is selected () , the text string that is read from the file is included in the file name. If a file name is set, the set file name will be used for transmission.
- You can set the accuracy of OCR in [OCR Accuracy:]. Select from [Auto] or [Priority Text]. When [Priority Text] is selected, the character reading accuracy is raised before scanning. When [Priority Text] is selected, accuracy in diagram and table areas may be degraded. Only change the setting when you particularly want to increase the accuracy of text areas.

5

To select more detailed settings, tap the [Detail] key to switch to normal mode.

- ▶ [Changing mode from each mode \(page 5-10\)](#)

6

Tap the [File Format] key.

7

Tap the [Colour/Greyscale] or [B/W] tab and select the format mode for scanning.



- The format setting for [B/W] mode is the file format with the colour mode set to [Mono2].
- The format setting for [Colour/Greyscale] mode is the file format with the colour mode set to [Full Colour] or [Greyscale].



8

Tap the key of the desired file type.

MX-2630N/MX-3050V/MX-3550V/MX-4050V/MX-5050V/MX-6050V

When the [B/W] key is selected

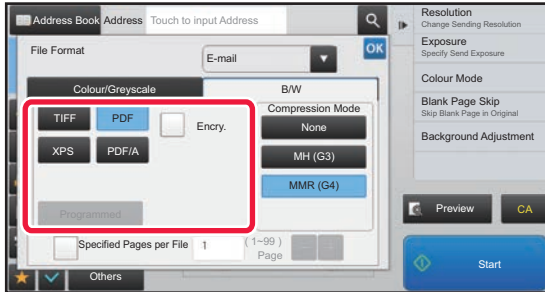

When the [Colour/Greyscale] key is selected

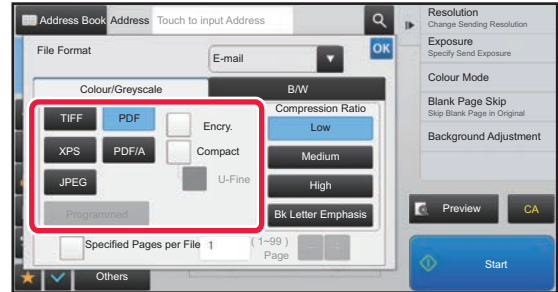

MX-3060V/MX-3070V/MX-3560V/MX-3570V/MX-4060V/MX-4070V/MX-5070V/MX-6070V

When the [B/W] key is selected

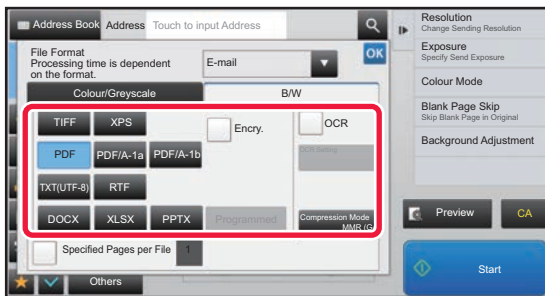

When the [Colour/Greyscale] key is selected

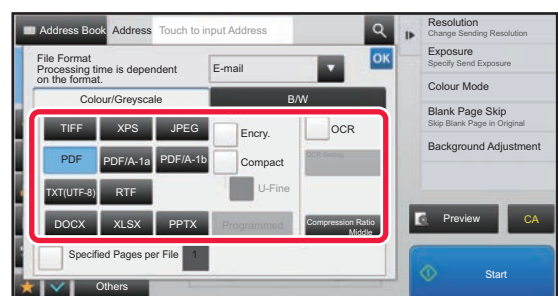

When [Colour/Greyscale] mode is selected, the [Compact] and [U-Fine] checkboxes appear. To suppress image quality deterioration and reduce the data size of a file to be transmitted, select Compact PDF. Select [U-Fine] only when you select Compact PDF.*

* On the MX-3050V/MX-3550V/MX-4050V/MX-5050V/MX-6050V, the Enhanced compression kit is required. When using the MX-2630N, Compact PDF cannot be selected because the enhanced compression kit cannot be installed.



9

(MX-3060V/MX-3070V/MX-3560V/MX-3570V/MX-4060V/MX-4070V/MX-5070V/MX-6070V only) Tap the [Compression Mode] key or [Compression Ratio] key.

10

Tap the Compression key or Compression Ratio key.

MX-3050V/MX-3550V/MX-4050V/MX-5050V/MX-6050V

When the [B/W] key is selected

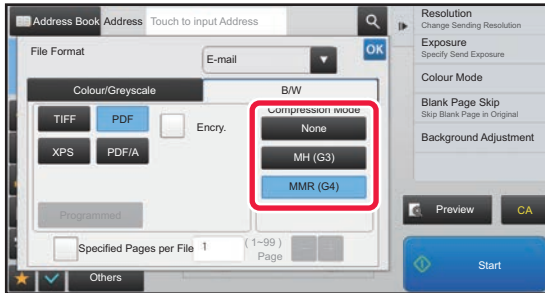

When the [Colour/Greyscale] key is selected

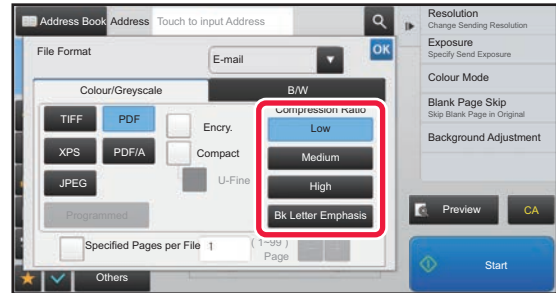

MX-3060V/MX-3070V/MX-3560V/MX-3570V/MX-4060V/MX-4070V/MX-5070V/MX-6070V

When the [B/W] key is selected



When the [Colour/Greyscale] key is selected

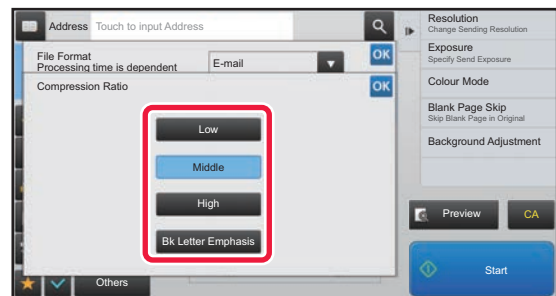

- [Bk Letter Emphasis] in the [Colour/Greyscale] tab is a file format that reduces the data size while suppressing deterioration of black text.
- On the MX-3060V/MX-3070V/MX-3560V/MX-3570V/MX-4060V/MX-4070V/MX-5070V/MX-6070V, tap **OK** when you have completed the settings.

11

To change the number of pages per file, set the [Specified Pages per File] checkbox to , and use numeric keys to specify the number of pages per file.



- When the [Specified Pages per File] checkbox is , one file is created for each of the number of pages at the right. When the checkmark is removed, one file is created for all pages.
- When [Specified Pages per File] is selected, consecutive numbers are added to the created file names.
- When [JPEG] is selected for the file type, one file is created for each page. For this reason, the [Specified Pages per File] checkbox does not appear.



CHANGING FORMAT IN INTERNET FAX MODE

The format for Internet Fax mode is set in the system settings.

► [Internet Fax Settings \(page 7-102\)](#)

CHANGING COLOUR MODE

Change the colour mode used to scan the original.

In Easy mode

Tap the [B/W Start] or [Colour Start] key when scanning the original.



To set the settings used when each key is tapped, select "Settings (Web version)" - [System Settings]→ [Image Send Settings] → [Scan Settings] → [Initial Status Settings] → [Easy Scan Settings].

In Normal mode

Mode	Scanning method
Auto	The machine detects whether the original is colour or black and white and automatically selects full colour or black and white (Mono2 or Greyscale) scanning.
Full Colour	The original is scanned in full colour. This mode is best for full colour originals such as catalogues.
Mono2	Colours in the original are scanned as black or white. This mode is best for text-only originals.
Greyscale	The colours in the original are scanned in black and white as shades of grey (greyscale).



This function cannot be used in Internet fax mode.

1

Tap the [Detail] key to switch to the normal mode.

► [Changing mode from each mode \(page 5-10\)](#)

2

Tap the [Colour Mode] key.

3

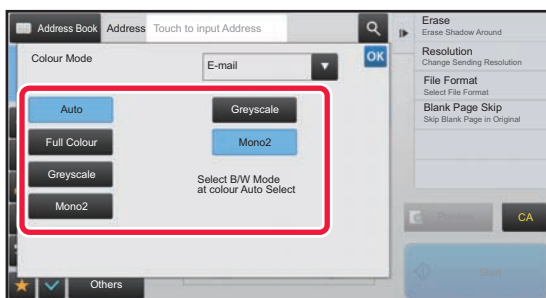

Tap the key of the desired colour mode for the original.



If there is a mix of destinations in different send modes, tap ▼ to select a send mode (E-mail, DeskTop/FTP or Data Entry) to set the colour mode for each mode.



4

Tap the [Greyscale] or [Mono2] key to set the B/W mode for automatic colour selection.

Specify whether Mono2 or greyscale is used when scanning black and white originals. Note that if the file format is set to JPEG, scanning will take place in greyscale.

After the settings are completed, tap **OK**.



The B/W mode can be set only when the [Auto] key is selected in the colour mode setting (step 3).



SETTING SCAN SETTINGS AUTOMATICALLY (Auto Set) (MX-3060V/MX-3070V/MX-3560V/MX-3570V/ MX-4060V/MX-4070V/MX-5070V/MX-6070V only)

To automatically set scan settings appropriate for the original, tap the [Auto Set] key in the base screen of Easy Mode.

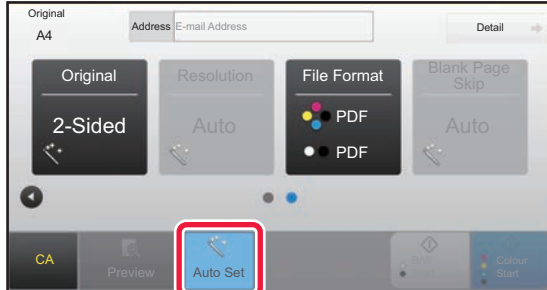

The following functions are set automatically.

- Image Orientation
- Resolution
- Blank Page Skip

Each function setting value/parameter can be changed in setting mode.



- When "Auto Set" is enabled, greyed out functions cannot be enabled.
- When an Internet Fax address is selected, "Auto Set" cannot be enabled.



To change the "Auto Set" setting, use "Settings (administrator)" - [System Settings] → [Image Send Settings] → [Scan Settings] → [Condition Settings] → [Auto Scan Setting].

CHECKING THE IMAGE TO BE TRANSMITTED

Check the image that will be sent in the touch panel before transmission.

You can tap the [Preview] key to check a preview of the image before sending an image. As you can adjust the exposure and resolution to scan the original while checking it in the preview screen, you can send a better quality original to the destination.



- Depending on the size of the transmission data, part of the preview image may not appear in the preview screen in the touch panel.
- The preview function is not available when the original size is set to Long Size.



OTHER FUNCTIONS

STORING SCAN OPERATIONS (PROGRAM)

This function collectively stores various settings as one program. The stored program can be retrieved using an easy operation.
For example, suppose A4 (8-1/2" x 11") size documents are scanned into a file and sent to each branch office once a month.

- The same documents are sent to each branch office
- Each page of a bound document is successively transmitted
- Smudges on the edges of the documents are erased before transmission

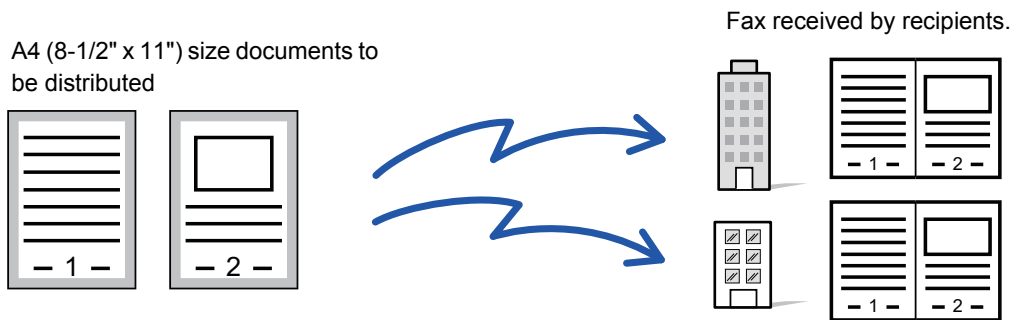

When a job program is not stored	When a job program is stored
<p>Enter the address of each branch office.</p> <p>↓</p> <p>Select Dual Page Scan.</p> <p>↓</p> <p>Specify Erase.</p> <p>↓</p> <p>Tap the [Start] key.</p> <p>Scan and send the original.</p>	<p>Tap the key of a stored program.</p> <p>↓</p> <p>Tap the [Start] key.</p> <p>Scan and send the original.</p>
<p>Considerable time is required to send the documents each month because the above settings must be selected. In addition, mistakes are occasionally made when selecting the settings.</p>	<p>When a program is stored, settings are selected with ease by simply tapping the key of the program. In addition, transmission takes place based on the stored settings so there are no chances for mistakes.</p>

To configure a program:



Tap [Program Registration - Register Current Settings] on the action panel that appears when you operate any mode screens.



- The settings stored in a program will be retained even after the program is used for transmission. The same settings can be used repeatedly for transmission.
- The following contents cannot be stored in programs:
 - Tapping of the [Speaker] key
 - Quick File
 - File
 - Page changes and unspecified erases during preview
 - Metadata Settings
 - Send Settings
 - Own Name
 - Sign E-mail
 - Encrypt E-mail
- Up to 48 programs can be stored.
- Up to 500 destinations can be stored in one program.
- A program in which sub addresses and passcodes are specified as an F-code destination records all sub addresses and passcodes.



This function cannot be used in data entry mode.

1

Tap the [Detail] key to switch to the normal mode.

► [Changing mode from each mode \(page 5-10\)](#)

2

Place the original and tap [Call Program] on the action panel.

According to the function stored in the program, place the original in the document feeder tray of the automatic document feeder, or on the document glass.

- [AUTOMATIC DOCUMENT FEEDER \(page 1-84\)](#)
- [DOCUMENT GLASS \(page 1-86\)](#)

3

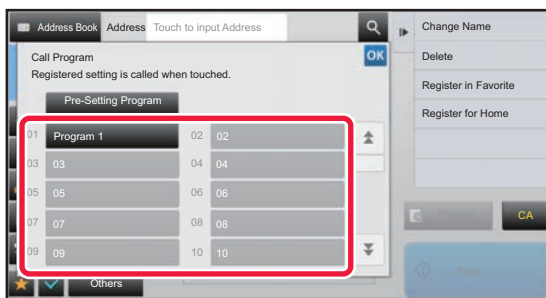

Tap the desired program key.

4

Configure additional settings if needed.



Some settings cannot be added depending on the contents of the called program.



5

Tap the [Start] key to start scanning of the original.

- A beep will sound to indicate that scanning and transmission have ended.
- When you place the original on the document glass, scan each page one at a time.
When scanning finishes, place the next original and tap the [Start] key.
Repeat until all pages have been scanned and then tap the [Read-End] key.



You can tap the [Preview] key to check a preview of the image before sending an image. For more information, see "[CHECKING THE IMAGE TO BE TRANSMITTED \(page 5-68\)](#)".



SCANNING AND SENDING ORIGINALS COLLECTIVELY

SENDING TWO PAGES AS A SINGLE PAGE (N-Up)

Reduce two original pages to the equal size and send them as a single page. This function is convenient when you have a large number of original pages and wish to reduce the number of pages sent.

For the standard size (A4 (8-1/2" x 11"), B5 or A5 (5-1/2" x 8-1/2")), original pages are scanned from both the single pass feeder and document glass.

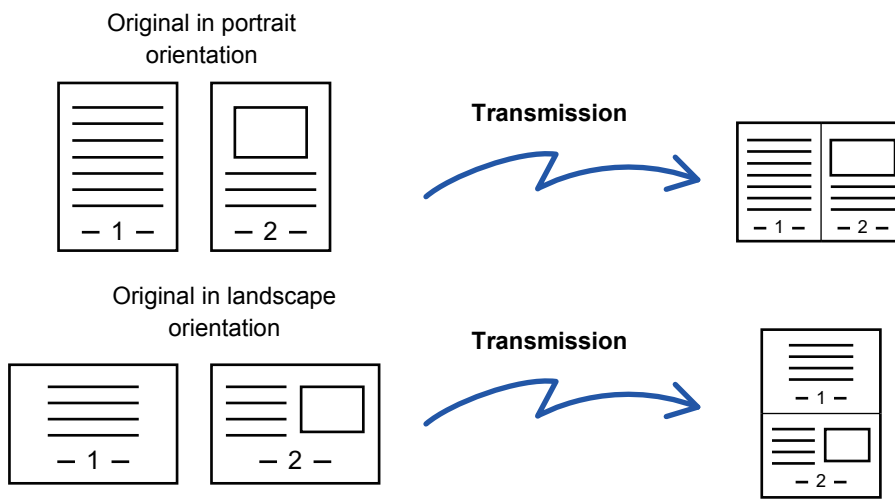

- This function cannot be used in scan mode or data entry mode.
- The N-Up is only available for originals with A4 (8-1/2" x 11"), B5 or A5 (5-1/2" x 8-1/2") size.
- Transmission is not possible at a size smaller than the original size.
- When the scan size of the original is specified by numeric values, this function cannot be used.
- This function cannot be used together with Dual Page Scan or Card Shot.

1

Place the original.

Place the original in the document feeder tray of the automatic document feeder, or on the document glass.

- ▶ [AUTOMATIC DOCUMENT FEEDER \(page 1-84\)](#)
- ▶ [DOCUMENT GLASS \(page 1-86\)](#)



2

Tap the mode display to switch to the initial screen of Internet Fax mode.

▶ [Changing mode from each mode \(page 5-10\)](#)

3

Specify the destination.

- ▶ [RETRIEVING A DESTINATION FROM AN ADDRESS BOOK \(page 5-16\)](#)
- ▶ [VIEWING A LIST OF THE SELECTED DESTINATIONS \(page 5-19\)](#)
- ▶ [USING A SEARCH NUMBER TO RETRIEVE A DESTINATION \(page 5-20\)](#)
- ▶ [ENTERING AN ADDRESS MANUALLY \(page 5-21\)](#)
- ▶ [SPECIFYING A NETWORK FOLDER \(page 5-22\)](#)
- ▶ [RETRIEVING A DESTINATION FROM A GLOBAL ADDRESS BOOK \(page 5-23\)](#)
- ▶ [USING A TRANSMISSION LOG TO RESEND \(page 5-25\)](#)

4

Tap the [Others] key, and tap the [N-Up] key.

A checkmark appears on the icon.

After the settings are completed, tap the [Back] key.



To cancel the N-Up setting

Tap the [N-Up] key to uncheck it.

5

Tap the [Original] key.

6

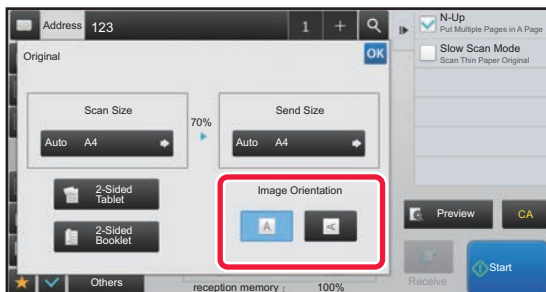

Tap the [Image Orientation] key with the same orientation as the original image.

If this setting is not correct, a suitable image may not be transmitted.

After the settings are completed, tap **OK**.

7

Tap the [Start] key to start scanning of the original.

- If you inserted the original pages in the document feeder tray, all pages are scanned. A beep will sound to indicate that scanning and transmission have ended.
- When you place the original on the document glass, scan each page one at a time. When scanning finishes, place the next original and tap the [Start] key. Repeat the procedure until all pages have been scanned and then tap the [Read-End] key. A beep will sound to indicate that scanning and transmission have ended.



You can tap the [Preview] key to check a preview of the image before sending an image. For more information, see "[CHECKING THE IMAGE TO BE TRANSMITTED \(page 5-68\)](#)".

Tap the [Change Setting] key in the scan-end confirmation screen to change the exposure, resolution, scan size, and send size. (However, when scanning each even-numbered page of the original, only the exposure is changed.)



SCANNING ORIGINALS OF DIFFERENT SIZES (MIXED SIZE ORIGINAL)

Scan originals of different sizes at the same time; for example, when B4 (8-1/2" x 14") size originals are mixed together with A3 (11" x 17") size originals.

When scanning the originals, the machine automatically detects the size of each original.



This function can only be used with the combinations of original sizes as shown below.

- A3 and B4, A3 and B5, B4 and A4, and A4 and B5
- A4R and B5, B4 and A4R, B4 and A5, and B5 and A5
- 11" x 17" and 8-1/2" x 14", 11" x 17" and 8-1/2" x 13", and 11" x 17" and 5-1/2" x 8-1/2"



- On the MX-2630N/MX-3050V/MX-3550V/MX-3560V/MX-4050V/MX-4060V/MX-5050V/MX-6050V, two sided scanning cannot be used when scanning originals of mixed width as in the above.
- When Mixed Size Original is selected, an original scan size cannot be specified.
- After the original scan size has been selected, Mixed Size Original cannot be specified.
- Rotate cannot be used when Mixed Size Original is enabled.
- This function is not available if [System Settings] → [Common Settings] → [Device Control] → [Original Size Detector Setting] is set to "AB-3" in "Settings (administrator)".

1

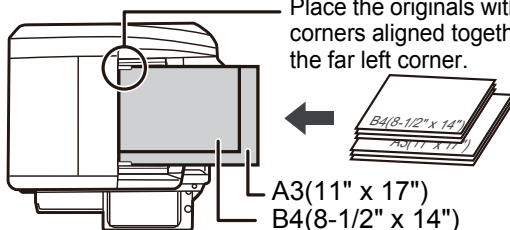

Place the originals with the corners aligned together in the far left corner.

Place the original in the document feeder tray of the automatic document feeder.

Insert the originals with the corners aligned together in the far left corner of the document feeder tray.

▶ [AUTOMATIC DOCUMENT FEEDER \(page 1-84\)](#)

2

Tap the mode display to switch to the initial screen of each mode.

▶ [Changing mode from each mode \(page 5-10\)](#)

3

Specify the destination.

- ▶ [RETRIEVING A DESTINATION FROM AN ADDRESS BOOK \(page 5-16\)](#)
- ▶ [VIEWING A LIST OF THE SELECTED DESTINATIONS \(page 5-19\)](#)
- ▶ [USING A SEARCH NUMBER TO RETRIEVE A DESTINATION \(page 5-20\)](#)
- ▶ [ENTERING AN ADDRESS MANUALLY \(page 5-21\)](#)
- ▶ [SPECIFYING A NETWORK FOLDER \(page 5-22\)](#)
- ▶ [RETRIEVING A DESTINATION FROM A GLOBAL ADDRESS BOOK \(page 5-23\)](#)
- ▶ [USING A TRANSMISSION LOG TO RESEND \(page 5-25\)](#)



4

Tap the [Mixed Size Original] key. Otherwise, tap the [Others] key, and tap the [Mixed Size Original] key.

A checkmark appears on the icon.

After the settings are completed, tap the [Back] key.



For mixed size originals, set "Original" to "Auto".



To cancel the mixed size original setting

Tap the [Mixed Size Original] key to uncheck it.

5

Tap the [Start] key to start scanning of the original.

A beep will sound to indicate that scanning and transmission have ended.



Tap the [Preview] key to check the preview of an image before sending a fax. For more information, see "[CHECKING THE IMAGE TO BE TRANSMITTED \(page 5-68\)](#)". However, settings for this function cannot be changed in the preview screen.



SCANNING BOTH SIDES OF A CARD ONTO A SINGLE PAGE (CARD SHOT)

Send the front and reverse sides of a card as a single page, without the need to send each side separately.

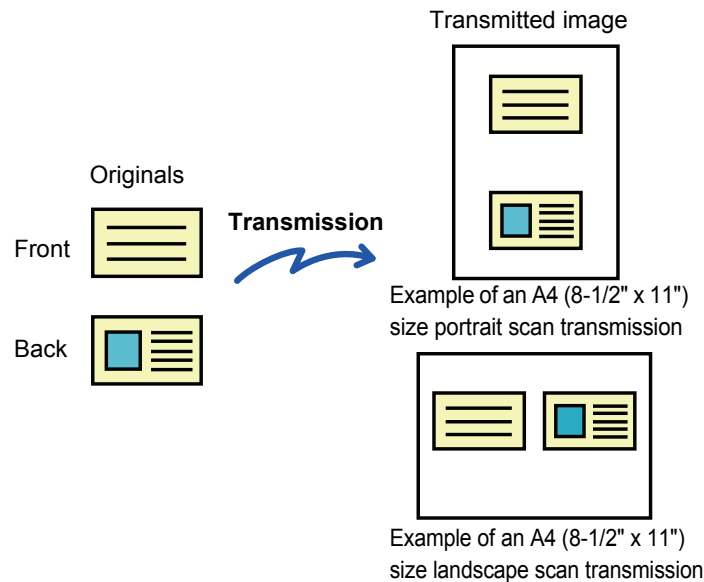

- If the scan size is larger than the send size, it will result in a sending failure.
- The ratio cannot be specified and "Rotation Sending Setting" cannot be selected.

1

Place a card face down on the document glass.

- ▶ [DOCUMENT GLASS \(page 1-86\)](#)

2

Tap the mode display to switch to the initial screen of each mode.

- ▶ [Changing mode from each mode \(page 5-10\)](#)

3

Specify the destination.

- ▶ [RETRIEVING A DESTINATION FROM AN ADDRESS BOOK \(page 5-16\)](#)
- ▶ [VIEWING A LIST OF THE SELECTED DESTINATIONS \(page 5-19\)](#)
- ▶ [USING A SEARCH NUMBER TO RETRIEVE A DESTINATION \(page 5-20\)](#)
- ▶ [ENTERING AN ADDRESS MANUALLY \(page 5-21\)](#)
- ▶ [SPECIFYING A NETWORK FOLDER \(page 5-22\)](#)
- ▶ [RETRIEVING A DESTINATION FROM A GLOBAL ADDRESS BOOK \(page 5-23\)](#)
- ▶ [USING A TRANSMISSION LOG TO RESEND \(page 5-25\)](#)

4

Tap the [Others] key, and tap the [Card Shot] key.



5

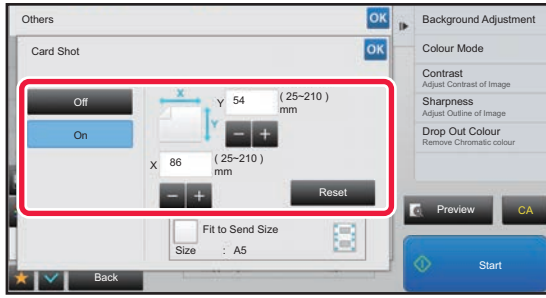

Tap the [On] key, and specify the original size as required.

After the settings are completed, tap **OK** and [Back] keys in sequence.



- Tap the areas displaying width and height sizes respectively, and enter the sizes using the numeric keys.
- To quickly set the size, first specify a value close to the desired ratio value by the numeric keys, then tap [-] or [+] for adjustment .
- To enlarge or reduce the images to fit the paper based on the entered original size, tap the [Fit to Send Size] key.
- After selecting Card Shot, tap the [Original] key in the base screen to change the original scan size or the send size. In this case, the screen of this step appears when you tap the scan size key. For the procedure for setting the send size, see "[SPECIFYING THE SEND SIZE OF THE IMAGE \(page 5-55\)](#)".



To cancel the Card Shot settings
Tap the [Off] key.

6

Tap the [Start] key, and scan the front side.

7

Place a card face up on the document glass, and tap the [Start] key to scan the reverse side.



Before scanning the back of the card, tap the [Change Setting] key on the touch panel to change the exposure.

8

Tap the [Read-End] key.



If you will continue by scanning the front of the card, you can tap the [Change Setting] key to change the exposure, resolution, scan size, and send size.



SIMULTANEOUSLY SCANNING MULTIPLE CARDS, RECEIPTS OR OTHER SMALL ORIGINALS TO INDIVIDUAL FILES (MULTICROP)

This function automatically crops and scans multiple cards, receipts, or other small originals placed on the document glass to individual files.

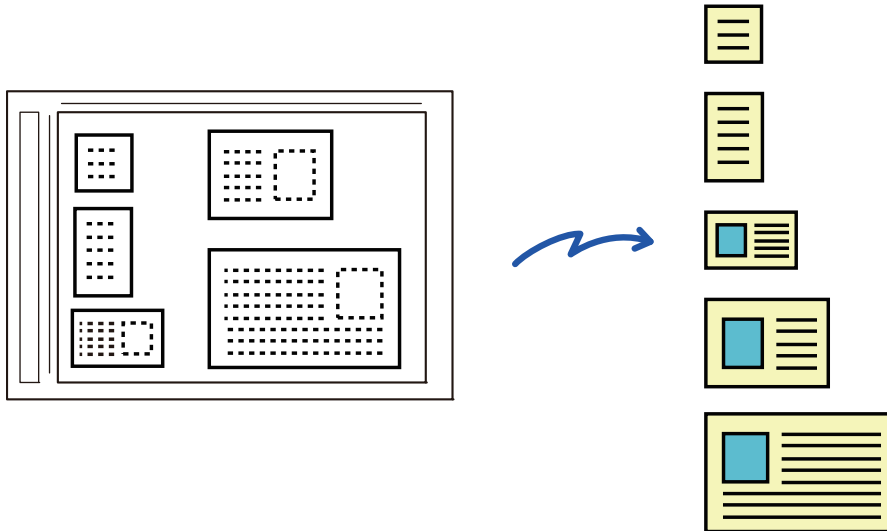

- This function can be used with Scan to E-mail, Scan to FTP/Desktop, Scan to Network Folder, and Save to External Memory Device.
- The e-mail will be sent without being divided if System Settings - [Image Send Settings]→[Scan Settings]→[Condition Settings]→[If the E-mail attachment(s) exceed maximum size, it will be sent in multiple files.] is enabled and [Maximum Size of E-mail Attachments(E-Mail)] is set. If the transmitted e-mail exceeds the limit, a send error occurs.

1

Place the multiple originals that you want to scan on the document glass.

► [DOCUMENT GLASS \(page 1-86\)](#)



Cautions when placing the originals

- Up to 50 originals can be placed at once.
- Separate the originals by at least 5 mm.
- Available originals sizes are 40 to 297 mm in height and 40 to 432 mm in width.
- If the shape of an original is not square or rectangular, the original may not be cropped correctly.

2

Keep the auto document feeder open, not closed.

If you scan the originals with the auto document feeder closed, it will not be possible to detect the outlines of the originals and scanning will fail. Always use this function with the auto document feeder open. If a light source such as an electric light shines onto the originals during scanning, cropping may not be successful. Adjust the angle of the automatic document feeder so that the light source does not affect the image.



Do not look directly at the light during scanning.



3

Tap the mode display and change to the base screen of the desired mode.

- ▶ [Changing mode from each mode \(page 5-10\)](#)

4

Specify the destination.

- ▶ [RETRIEVING A DESTINATION FROM AN ADDRESS BOOK \(page 5-16\)](#)
- ▶ [VIEWING A LIST OF THE SELECTED DESTINATIONS \(page 5-19\)](#)
- ▶ [USING A SEARCH NUMBER TO RETRIEVE A DESTINATION \(page 5-20\)](#)
- ▶ [ENTERING AN ADDRESS MANUALLY \(page 5-21\)](#)
- ▶ [SPECIFYING A NETWORK FOLDER \(page 5-22\)](#)
- ▶ [RETRIEVING A DESTINATION FROM A GLOBAL ADDRESS BOOK \(page 5-23\)](#)
- ▶ [USING A TRANSMISSION LOG TO RESEND \(page 5-25\)](#)

5

Tap the [Others] key, and tap the [Multicrop] key.

A checkmark appears on the icon. When you have completed the setting, tap the [Back] key.



When original count is enabled, the number of scanned originals will appear during scanning.

**To cancel the multicrop setting**

Tap the [Multicrop] key to remove the checkmark.

6

Tap the [Start] key to start scanning the originals.

When scanning is completed, place the next originals and tap the [Start] key.

Repeat the above step until you have scanned all originals, and then tap the [Read-End] key.

When transmission is completed, a beep sounds.

**• Restrictions when multicrop is enabled**

The following restrictions apply when multicrop is enabled. Restricted items may change automatically in some cases.

- Resolution: 600 x 600 dpi cannot be used.
- Scan size / send size: Only auto can be used.
- Two-sided original: Only one-sided original is enabled.
- Image Orientation: Cannot be used. (Each cropped original is corrected to the orientation that is least skewed.)
- Format: High compression and ultra-fine cannot be used.
- Compression / compression format: Black text emphasis cannot be used.
- One file per page: Cannot be set when the checkmark is enabled and the number is "1".
- The following functions cannot be used at the same time as multicrop.
Job Build, Slow Scan Mode, Mixed Size Original, Erase, Dual Page Scan, Book Divide, Card Shot, Verif. Stamp, Blank Page Skip, File, Quick File, Preview, Business Card Scan, Image Crop
- When the Multicrop setting is canceled, the following items retain the setting changes that occurred when Multicrop was enabled.
Resolution, Scan Size, Send Size, 2-Sided Original, File Type, OCR, Compression Mode/Compression Ratio, Specified Pages per File
- Depending on the original, it may not be extracted to the file correctly.



SCANNING A BUSINESS CARD, READING THE TEXT STRING, CREATING A FILE, AND SENDING THE FILE (BUSINESS CARD SCAN) (MX-3060V/MX-3070V/MX-3560V/MX-3570V/MX-4060V/MX-4070V/MX-5070V/MX-6070V only)

You can scan a business card, extract the name and telephone number from the text string read by OCR, and create and send a vCard or other file.

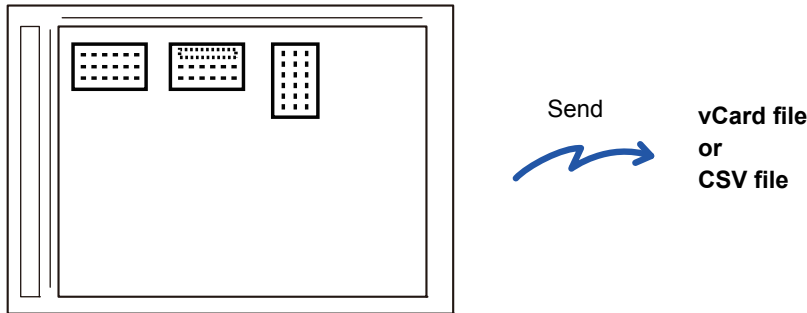

This function can be used with Scan to E-mail, Scan to FTP/Desktop, Scan to Network Folder, and Save to External Memory Device.

The e-mail will be sent without being divided if System Settings - [Image Send Settings]→[Scan Settings]→[Condition Settings]→[If the E-mail attachment(s) exceed maximum size, it will be sent in multiple files.] is enabled and [Maximum Size of E-mail Attachments(E-Mail)] is set. If the transmitted e-mail exceeds the limit, a send error occurs.

For the information that can be extracted and output from a scanned business card, refer to the table below.

Item	Description
Name	The name is extracted.
Kana	When the language is set to Japanese, you can convert the name to kana.
Pinyin	When the language is set to Chinese, you can convert the name to pinyin.
Postal code	The postal code is extracted.
Address	The address is extracted.
Company/group name	The company/organization name is extracted.
Department	The department is extracted.
Job title	The position is extracted.
Telephone number	The telephone number is extracted. Up to five.
Fax number	The fax number is extracted. Up to five.
URL	The URL is extracted. Up to five.
E-mail address	The E-mail address is extracted.
Other	Other is used if none of the above apply.



1

Place the multiple business cards that you want to scan on the document glass.► [DOCUMENT GLASS \(page 1-86\)](#)**Cautions when placing business cards**

- Up to 20 business cards can be placed at once.
- Separate the business cards by at least 5 mm.
- Available business card sizes are 45 x 85 mm to 110 x 110 mm.
- If the shape of a business card is not square or rectangular, the business card may not be cropped correctly.
- Place the business cards with the top side of the cards at the far side of the document glass as shown. If the cards are placed in the wrong orientation, it will not be possible to read the cards correctly.

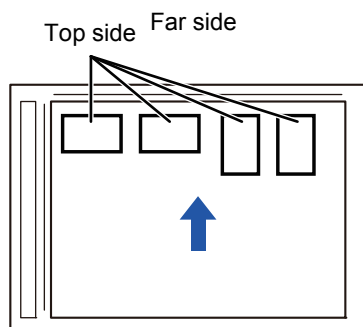

2

Keep the auto document feeder open, not closed.

If you scan the business cards with the auto document feeder closed, it will not be possible to detect the outlines of the business cards and scanning will fail. Always use this function with the auto document feeder open. If a light source such as an electric light shines onto the originals during scanning, cropping may not be successful. Adjust the angle of the automatic document feeder so that the light source does not affect the image.



Do not look directly at the light during scanning.

3

Tap the mode display and change to the base screen of the desired mode.► [Changing mode from each mode \(page 5-10\)](#)

4

Specify the destination.

- [RETRIEVING A DESTINATION FROM AN ADDRESS BOOK \(page 5-16\)](#)
- [VIEWING A LIST OF THE SELECTED DESTINATIONS \(page 5-19\)](#)
- [USING A SEARCH NUMBER TO RETRIEVE A DESTINATION \(page 5-20\)](#)
- [ENTERING AN ADDRESS MANUALLY \(page 5-21\)](#)
- [SPECIFYING A NETWORK FOLDER \(page 5-22\)](#)
- [RETRIEVING A DESTINATION FROM A GLOBAL ADDRESS BOOK \(page 5-23\)](#)
- [USING A TRANSMISSION LOG TO RESEND \(page 5-25\)](#)

5

Tap the [Others] key, and tap the [Business Card Scan] key.

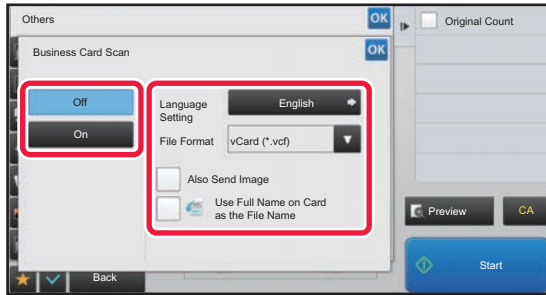

6

**Tap the [On] key, and change settings as needed.**

When you have completed the settings, tap the **OK** key and then the [Back] key.



- If original count is enabled, the number of scanned originals will appear during scanning.
- Change the language setting to match the language used on the business card. For the language settings, refer to "[CHANGING FORMAT IN SCAN OR DATA ENTRY MODE \(page 5-60\)](#)".
- To use the full name as the file name, enable [Use Full Name on Card as the File Name].
- To send the scanned image file together with the file format selected in [File Format], enable [Also Send Image].

**To cancel the business card scan setting**

Tap the [Off] key.

7

Tap the [Start] key to start scanning the originals.

When scanning is completed, place the next group of originals and tap the [Start] key.

Repeat the above step until you have scanned all originals, and then tap the [Read-End] key.

When transmission is completed, a beep sounds.

The image of the scanned business card is sent together with the VCard or CSV file set in File Format.

**Restrictions when Business Card Scan is enabled**

The following restrictions apply when Business Card Scan is enabled. Restricted items may change automatically in some cases.

- Resolution: Only 300 x 300 dpi or 400 x 400 dpi can be used.
- Scan size / send size: Only auto can be used.
- Two-sided original: Only one-sided original is enabled.
- Image Orientation: Cannot be used. (Each cropped original is corrected to the orientation that is least skewed.)
- Format: High compression and ultra-fine cannot be used.
- Compression / compression format: Black text emphasis cannot be used.
- One file per page: Cannot be set when the checkmark is enabled and the number is "1".
- The following functions cannot be used at the same time as multicrop.
Job Build, Slow Scan Mode, Mixed Size Original, Erase, Dual Page Scan, Book Divide, Card Shot, Verif. Stamp, Blank Page Skip, File, Quick File, Preview, Multicrop, Image Crop
- When the Business Card Scan setting is canceled, the following items retain the setting changes that occurred when Business Card Scan was enabled.
Resolution, Scan Size, Send Size, 2-Sided Original, File Type, OCR, Compression Mode/Compression Ratio, Specified Pages per File
- Depending on the business card, it may not be extracted to the file correctly.



File names

The user can assign any file name to a file.

When [Use Full Name on Card as the File Name] is enabled, the name on a scanned business card can be assigned as the file name.

If you do not set a file name, the machine will assign an automatically generated file name.

File name rules

File names are assigned as follows in each setting.

Setting	File	File name	Description
User entry	vCard	User_0001.vcf User_0002.vcf	The name entered by the user ("User" in this case) is inserted at the beginning of the file name.
	CSV	User.csv	
	Scanned image	User_0001.jpg User_0002.jpg	
File name auto extraction	vCard	AAAAAA_0001.vcf AAAAAA_0002.vcf BBBBBB_0001.vcf Untitled_0001.vcf Untitled_0002.vcf	Example: The names read from business cards are "AAAAAA", "BBBBB" When there are cards with the same first and last name such as "AAAAAA", the number at the end is a serial number. If the name could not be read, the file name is "Untitled". If there are multiple untitled files, the number at the end is a serial number.
	CSV	AAAAAA_0001.csv	
	Scanned image	AAAAAA_0001.jpg AAAAAA_0002.jpg BBBBBB_0001.jpg Untitled_0001.jpg Untitled_0002.jpg	
Automatic generation	vCard	MXxxxx_yyyyyy_zzzzzz_0001.vcf MXxxxx_yyyyyy_zzzzzz_0002.vcf	"xxxx" is the model name, "yyyyyy" is the scan date, and "zzzzzz" is the scan time.
	CSV	MXxxxx_yyyyyy_zzzzzz_0001.csv	
	Scanned image	MXxxxx_yyyyyy_zzzzzz_0001.jpg MXxxxx_yyyyyy_zzzzzz_0002.jpg	



If the user sets a file name when file name auto extraction is enabled, the user's file name is given priority.



SCANNING MULTIPLE PHOTOS AT ONCE TO INDIVIDUAL FILES (Image Crop)

This function automatically scans photographs placed on the document glass to individual files.

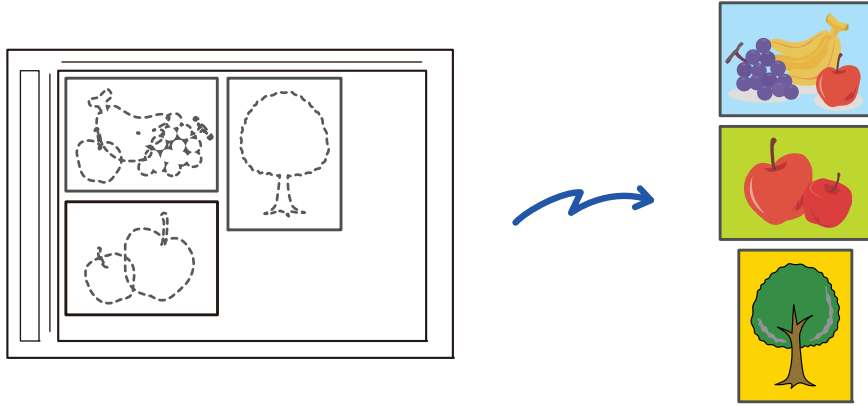

This function can be used with Scan to E-mail, Scan to FTP/Desktop, Scan to Network Folder, and Save to External Memory Device.

Settings (administrator) - "Image Send Settings" → "Scan Settings" → "Condition Settings" → "If the E-mail attachment(s) exceed maximum size, it will be sent in multiple files." is not applied.

If the transmitted e-mail exceeds the limit, a send error will occur.

1

Place the multiple originals that you want to scan on the document glass.

► [DOCUMENT GLASS \(page 1-86\)](#)



Cautions when placing the originals

- Up to 50 originals can be placed at once.
- Separate the originals by at least 5 mm.
- Available originals sizes are 40 to 297 mm in height and 40 to 432 mm in width.
- If the shape of an original is not square or rectangular, the original may not be cropped correctly.
- The top and bottom of each original cannot be distinguished automatically, so take care to orient the originals appropriately.

2

Close the automatic document feeder.

The scanning method is different from multi-crop. Close the automatic document feeder.

3

Tap the mode display and change to the home screen of the desired mode.

► [Changing mode from each mode \(page 5-10\)](#)



4

Specify the destination.

- ▶ [RETRIEVING A DESTINATION FROM AN ADDRESS BOOK \(page 5-16\)](#)
- ▶ [VIEWING A LIST OF THE SELECTED DESTINATIONS \(page 5-19\)](#)
- ▶ [USING A SEARCH NUMBER TO RETRIEVE A DESTINATION \(page 5-20\)](#)
- ▶ [ENTERING AN ADDRESS MANUALLY \(page 5-21\)](#)
- ▶ [SPECIFYING A NETWORK FOLDER \(page 5-22\)](#)
- ▶ [RETRIEVING A DESTINATION FROM A GLOBAL ADDRESS BOOK \(page 5-23\)](#)
- ▶ [USING A TRANSMISSION LOG TO RESEND \(page 5-25\)](#)

5

Tap the [Others] key, and tap the [Image Crop] key.

A checkmark appears on the icon. After the settings are completed, tap the [Back] key.



When original count is enabled, the number of scanned originals will appear during scanning.



To cancel the image crop setting

Tap the [Image Crop] key to remove the checkmark.

6

Tap the [Start] key to start scanning the originals.

When scanning is completed, place the next group of originals and tap the [Start] key.
Repeat the above step until you have scanned all originals, and then tap the [Read-End] key.
When transmission is completed, a beep sounds.



- Restrictions when image crop is enabled
The following restrictions apply when image crop is enabled. Restricted items may change automatically in some cases.
 - Scan size / send size: Only auto can be used.
 - Two-sided original: Only one-sided original is enabled.
 - Image Orientation: Cannot be used. (Each cropped original is corrected to the orientation that is least skewed.)
 - Format: High compression and ultra-fine cannot be used.
 - Compression / compression format: Black text emphasis cannot be used.
 - One file per page: Cannot be set when the checkmark is enabled and the number is "1".
 - The following functions cannot be used at the same time as image crop.
Job Build, Slow Scan Mode, Mixed Size Original, Erase, Dual Page Scan, Book Divide, Card Shot, Verif. Stamp, Blank Page Skip, File, Quick File, Preview, Multicrop Business Card Scan
- When the image crop setting is canceled, the following items retain the setting changes that occurred when image crop was enabled.
Resolution, Scan Size, Send Size, 2-Sided Original, File Type, OCR, Compression Mode/Compression Ratio, Specified Pages per File
- Depending on the photo, it may not be extracted to the file correctly.



SCANNING MANY ORIGINALS AT ONCE (JOB BUILD)

This function lets you separate an original consisting of numerous pages into sets, scan each set using the automatic document feeder, and transmit the pages in a single transmission. You can also send a fax by placing originals in both the automatic document feeder and on the document glass.

Use this function when there are more original pages than can be placed at once in the automatic document feeder.

When scanning originals that are separated into sets, scan the set that has the first page first.

The settings that you select for the first set can be used for all remaining sets.

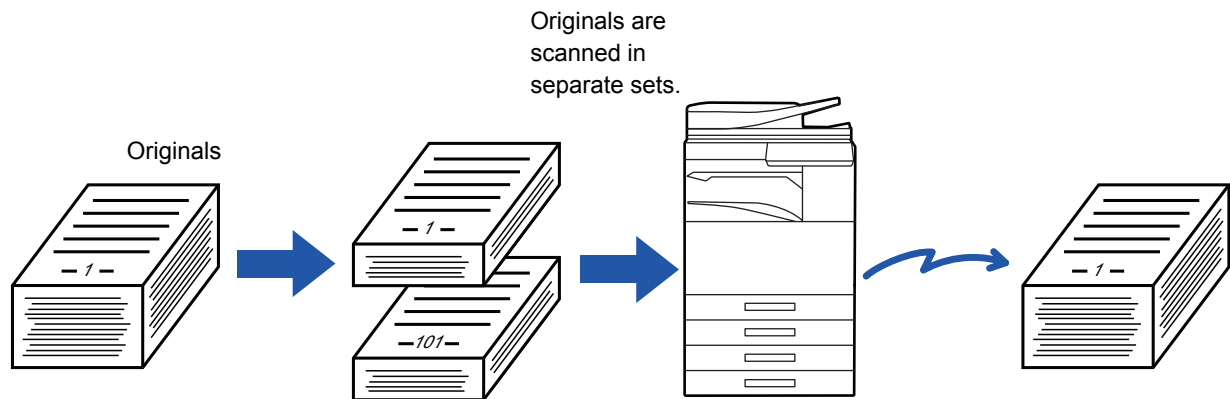

- Up to 9999 (excluding Internet Fax) pages can be scanned. Note that when the memory is being used for other jobs, fewer pages can be scanned.
- If the memory becomes full during scanning, a message will appear and the transmission will be cancelled.
- The scan settings can be changed for each set of originals.

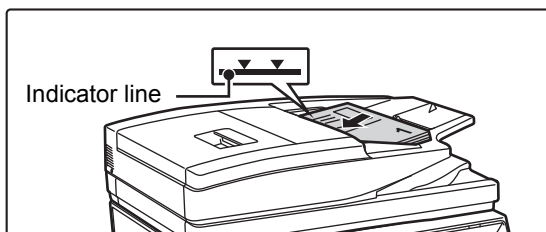
1

Place originals in the automatic document feeder.

Insert the originals all the way into the document feeder tray. Originals can be stacked up to the indicator line.

► [AUTOMATIC DOCUMENT FEEDER \(page 1-84\)](#)

2

Tap the mode display to switch to the initial screen of each mode.

► [Changing mode from each mode \(page 5-10\)](#)

3

Specify the destination.

- [RETRIEVING A DESTINATION FROM AN ADDRESS BOOK \(page 5-16\)](#)
- [VIEWING A LIST OF THE SELECTED DESTINATIONS \(page 5-19\)](#)
- [USING A SEARCH NUMBER TO RETRIEVE A DESTINATION \(page 5-20\)](#)
- [ENTERING AN ADDRESS MANUALLY \(page 5-21\)](#)
- [SPECIFYING A NETWORK FOLDER \(page 5-22\)](#)
- [RETRIEVING A DESTINATION FROM A GLOBAL ADDRESS BOOK \(page 5-23\)](#)
- [USING A TRANSMISSION LOG TO RESEND \(page 5-25\)](#)



4

Tap the [Job Build] key.

A checkmark appears on the icon.



If you are performing Scan to E-mail, tap the [Others] key and then tap the [Job Build] key.



To cancel the job build setting:

Tap the [Job Build] key to uncheck it.

5

Change settings as needed.

6

Tap the [Start] key to scan the first original page.

7

Place the next set of originals and tap the [Start] key.

Repeat until all originals have been scanned.



- If needed, tap [Change Setting] before tapping the [Start] key, and change the original scan settings and send settings for the next original. The setting changes will be applied to the next job.
- If you tap the [Preview] key, you cannot scan additional pages.



To cancel scanning:

Tap the [CA] key. All the settings including scanned data will be cleared.

8

Tap the [Read-End] key.



SCANNING AND SENDING AN ORIGINAL AS SEPARATE PAGES

SCANNING AN ORIGINAL AS TWO SEPARATE PAGES (DUAL PAGE SCAN)

The left and right sides of an original are scanned as two separate pages. This function is useful when you wish to successively scan each page of a book or other bound document.

When using dual page scan, the original must be placed on the document glass.

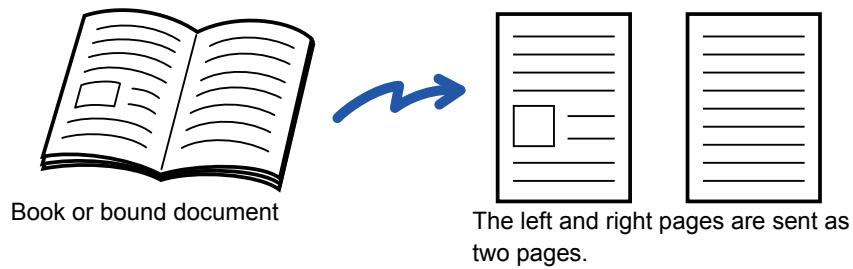

Original scan size	Transmitted image
A3 (11" x 17") x 1 page	A4 (8-1/2" x 11") x 2 pages
B4 (8-1/2" x 14") x 1 pages	B5 (5-1/2" x 8-1/2") x 2 pages



- This function is available when the original size setting is set to [Auto].
- Note that "Centre Erase" and "Edge+Centre Erase" cannot be used.



1

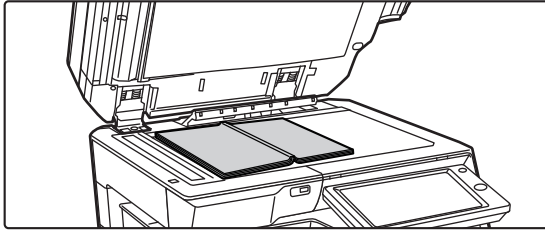

Place the original on the document glass.

▶ [DOCUMENT GLASS \(page 1-86\)](#)

Align the centre of the original with the appropriate size mark

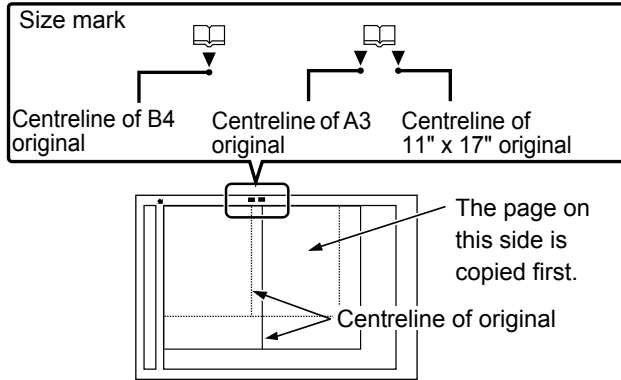

2

Tap the mode display to switch to the initial screen of each mode.

▶ [Changing mode from each mode \(page 5-10\)](#)

3

Specify the destination.

- ▶ [RETRIEVING A DESTINATION FROM AN ADDRESS BOOK \(page 5-16\)](#)
- ▶ [VIEWING A LIST OF THE SELECTED DESTINATIONS \(page 5-19\)](#)
- ▶ [USING A SEARCH NUMBER TO RETRIEVE A DESTINATION \(page 5-20\)](#)
- ▶ [ENTERING AN ADDRESS MANUALLY \(page 5-21\)](#)
- ▶ [SPECIFYING A NETWORK FOLDER \(page 5-22\)](#)
- ▶ [RETRIEVING A DESTINATION FROM A GLOBAL ADDRESS BOOK \(page 5-23\)](#)
- ▶ [USING A TRANSMISSION LOG TO RESEND \(page 5-25\)](#)

4

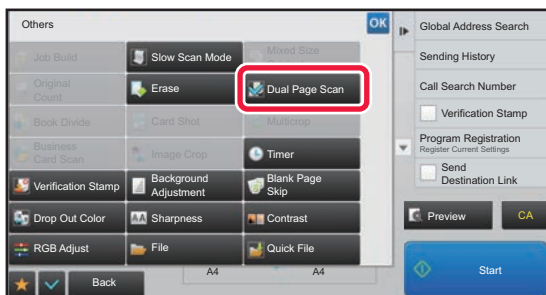

Tap the [Others] key, and tap the [Dual Page Scan] key.

A checkmark appears on the icon.

After the settings are completed, tap the [Back] key.



To cancel the dual page scan setting

Tap the [Dual Page Scan] key to uncheck it.



5

Tap the [Start] key to start scanning of the original.

When scanning finishes, place the next original and tap the [Start] key.
Repeat until all pages have been scanned and then tap the [Read-End] key.
A beep will sound to indicate that transmission has ended.



SPLITTING A PAMPHLET BY PAGE AND TRANSMITTING THE PAGES SUCCESSIVELY (BOOK DIVIDE)

The opened pages of a saddle-stitch pamphlet are split by page according to actual page order before transmission. When using this function, you do not need to sort the original pages to be sent.

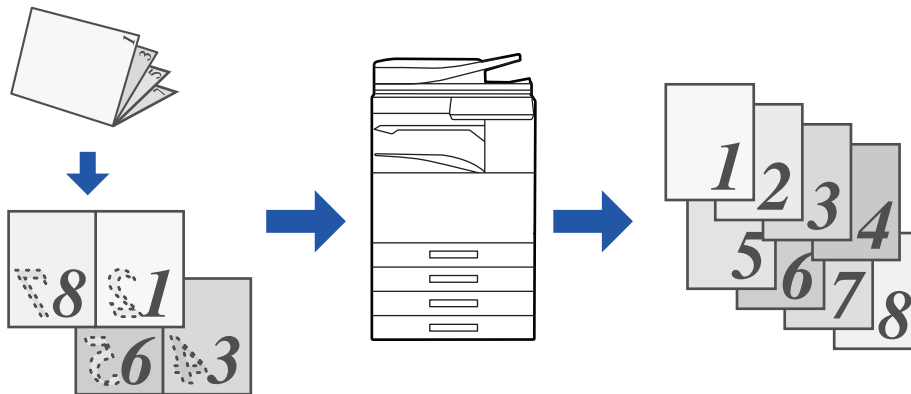

This function can be enabled when the original size setting is set to [Auto].



The document glass is not available for this function.

1

Place the original in the document feeder tray of the automatic document feeder.

▶ [AUTOMATIC DOCUMENT FEEDER \(page 1-84\)](#)

2

Tap the mode display to switch to the initial screen of each mode.

▶ [Changing mode from each mode \(page 5-10\)](#)

3

Specify the destination.

- ▶ [RETRIEVING A DESTINATION FROM AN ADDRESS BOOK \(page 5-16\)](#)
- ▶ [VIEWING A LIST OF THE SELECTED DESTINATIONS \(page 5-19\)](#)
- ▶ [USING A SEARCH NUMBER TO RETRIEVE A DESTINATION \(page 5-20\)](#)
- ▶ [ENTERING AN ADDRESS MANUALLY \(page 5-21\)](#)
- ▶ [SPECIFYING A NETWORK FOLDER \(page 5-22\)](#)
- ▶ [RETRIEVING A DESTINATION FROM A GLOBAL ADDRESS BOOK \(page 5-23\)](#)
- ▶ [USING A TRANSMISSION LOG TO RESEND \(page 5-25\)](#)

4

Tap the [Others] key, and tap the [Book Divide] key.



5

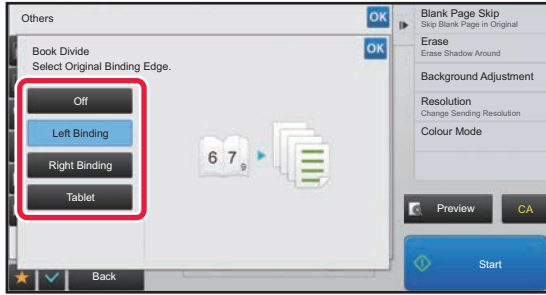

Select the binding edge of the pamphlet original.

After the settings are completed, tap **OK** and [Back] keys in sequence.



Check the preview image displayed in the screen, and make sure that the binding edge is correct.



To cancel the Book Divide setting:
Tap the [Off] key.

6

Tap the [Start] key to start scanning of the original.

A beep will sound to indicate that scanning and transmission have ended.



ADJUSTING COLOURS AND SHADING

ADJUSTING THE BACKGROUND BY MAKING LIGHT AREAS OF THE ORIGINAL DARKER OR LIGHTER (BACKGROUND ADJUSTMENT)

You can adjust the background by making light areas of the original darker or lighter.

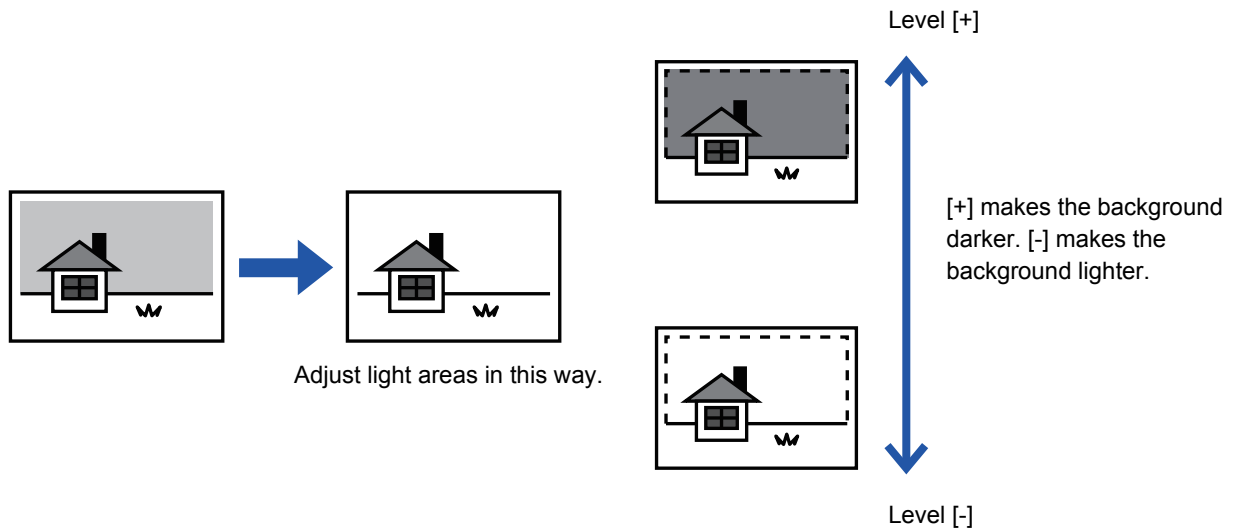

This function cannot be used in Internet fax mode.

1

Place the original.

Place the original in the document feeder tray of the automatic document feeder, or on the document glass.

- ▶ [AUTOMATIC DOCUMENT FEEDER \(page 1-84\)](#)
- ▶ [DOCUMENT GLASS \(page 1-86\)](#)

2

Tap the mode display to switch to the initial screen of each mode.

- ▶ [Changing mode from each mode \(page 5-10\)](#)

3

Specify the destination.

- ▶ [RETRIEVING A DESTINATION FROM AN ADDRESS BOOK \(page 5-16\)](#)
- ▶ [VIEWING A LIST OF THE SELECTED DESTINATIONS \(page 5-19\)](#)
- ▶ [USING A SEARCH NUMBER TO RETRIEVE A DESTINATION \(page 5-20\)](#)
- ▶ [ENTERING AN ADDRESS MANUALLY \(page 5-21\)](#)
- ▶ [SPECIFYING A NETWORK FOLDER \(page 5-22\)](#)
- ▶ [RETRIEVING A DESTINATION FROM A GLOBAL ADDRESS BOOK \(page 5-23\)](#)
- ▶ [USING A TRANSMISSION LOG TO RESEND \(page 5-25\)](#)



4

Tap the [Others] key, and tap the [Background Adjustment] key.

5

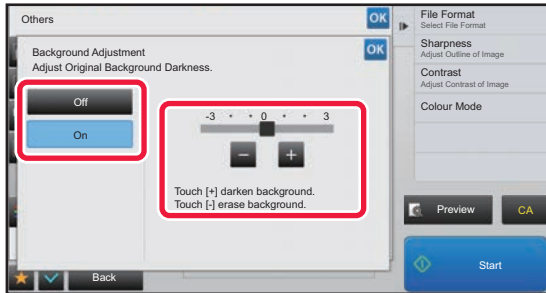

Tap **-** **+** or slide the slider to adjust the range to be suppressed.

After the settings are completed, tap **OK** and [Back] key in sequence.



To cancel the background adjustment setting:
Tap the [Off] key.

6

Tap the [Start] key to start scanning of the original.

- If you inserted the original pages in the document feeder tray, all pages are scanned. A beep will sound to indicate that scanning and transmission have ended.
- When you place the original on the document glass, scan each page one at a time. When scanning finishes, place the next original and tap the [Start] key. A beep will sound to indicate that transmission has ended.



- You can tap the [Preview] key to check a preview of the image before sending an image. For more information, see "[CHECKING THE IMAGE TO BE TRANSMITTED \(page 5-68\)](#)". However, settings for this function cannot be changed in the preview screen.
- When the colour mode setting is [Mono2], the background adjustment function will not operate.



ADDING CONTRAST TO THE SCANNED ORIGINAL BEFORE TRANSMISSION (CONTRAST)

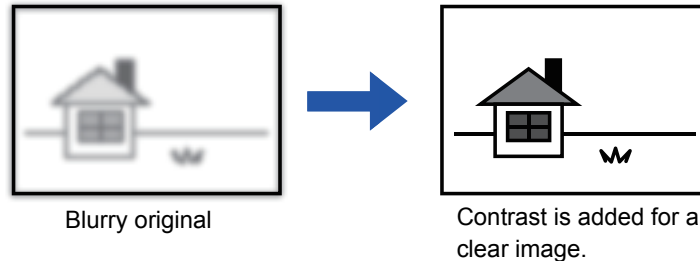

This function cannot be used in Internet fax mode.

1

Place the original.

Place the original in the document feeder tray of the automatic document feeder, or on the document glass.

- ▶ [AUTOMATIC DOCUMENT FEEDER \(page 1-84\)](#)
- ▶ [DOCUMENT GLASS \(page 1-86\)](#)

2

Tap the mode display to switch to the initial screen of each mode.

- ▶ [Changing mode from each mode \(page 5-10\)](#)

3

Specify the destination.

- ▶ [RETRIEVING A DESTINATION FROM AN ADDRESS BOOK \(page 5-16\)](#)
- ▶ [VIEWING A LIST OF THE SELECTED DESTINATIONS \(page 5-19\)](#)
- ▶ [USING A SEARCH NUMBER TO RETRIEVE A DESTINATION \(page 5-20\)](#)
- ▶ [ENTERING AN ADDRESS MANUALLY \(page 5-21\)](#)
- ▶ [SPECIFYING A NETWORK FOLDER \(page 5-22\)](#)
- ▶ [RETRIEVING A DESTINATION FROM A GLOBAL ADDRESS BOOK \(page 5-23\)](#)
- ▶ [USING A TRANSMISSION LOG TO RESEND \(page 5-25\)](#)

4

Tap the [Others] key, and tap the [Contrast] key.



5

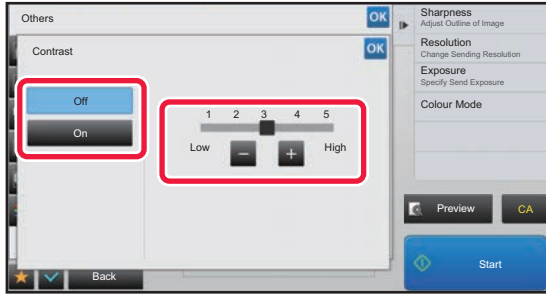

Tap **- +** or slide the slider to adjust the contrast level.

After the settings are completed, tap **OK** and [Back] keys in sequence.



To cancel the contrast settings:

Tap the [Off] key.

6

Tap the [Start] key to start scanning of the original.

- If you inserted the original pages in the document feeder tray, all pages are scanned. A beep will sound to indicate that scanning and transmission have ended.
- When you place the original on the document glass, scan each page one at a time. When scanning finishes, place the next original and tap the [Start] key. Repeat the procedure until all pages have been scanned and then tap the [Read-End] key. A beep will sound to indicate that scanning and transmission have ended.



You can tap the [Preview] key to check a preview of the image before sending an image. For more information, see "[CHECKING THE IMAGE TO BE TRANSMITTED \(page 5-68\)](#)". However, settings for this function cannot be changed in the preview screen.



ENHANCING THE OUTLINE OF THE SCANNED ORIGINAL BEFORE TRANSMISSION (SHARPNESS)

Blurry outlined original



Enhance the outline before transmitting.

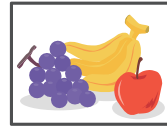

This function cannot be used in Internet fax mode.

1

Place the original.

Place the original in the document feeder tray of the automatic document feeder, or on the document glass.

- ▶ [AUTOMATIC DOCUMENT FEEDER \(page 1-84\)](#)
- ▶ [DOCUMENT GLASS \(page 1-86\)](#)

2

Tap the mode display to switch to the initial screen of each mode.

- ▶ [Changing mode from each mode \(page 5-10\)](#)

3

Specify the destination.

- ▶ [RETRIEVING A DESTINATION FROM AN ADDRESS BOOK \(page 5-16\)](#)
- ▶ [VIEWING A LIST OF THE SELECTED DESTINATIONS \(page 5-19\)](#)
- ▶ [USING A SEARCH NUMBER TO RETRIEVE A DESTINATION \(page 5-20\)](#)
- ▶ [ENTERING AN ADDRESS MANUALLY \(page 5-21\)](#)
- ▶ [SPECIFYING A NETWORK FOLDER \(page 5-22\)](#)
- ▶ [RETRIEVING A DESTINATION FROM A GLOBAL ADDRESS BOOK \(page 5-23\)](#)
- ▶ [USING A TRANSMISSION LOG TO RESEND \(page 5-25\)](#)

4

Tap the [Others] key, and tap the [Sharpness] key.



5

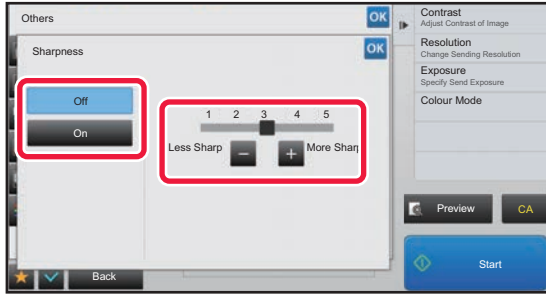

Tap **- +** or slide the slider to adjust the sharpness.

After the settings are completed, tap **OK** and [Back] keys in sequence.



To cancel the sharpness setting:

Tap the [Off] key.

6

Tap the [Start] key to start scanning of the original.

- If you inserted the original pages in the document feeder tray, all pages are scanned. A beep will sound to indicate that scanning and transmission have ended.
- When you place the original on the document glass, scan each page one at a time. When scanning finishes, place the next original and tap the [Start] key. Repeat the procedure until all pages have been scanned and then tap the [Read-End] key. A beep will sound to indicate that scanning and transmission have ended.



You can tap the [Preview] key to check a preview of the image before sending an image. For more information, see "[CHECKING THE IMAGE TO BE TRANSMITTED \(page 5-68\)](#)". However, settings for this function cannot be changed in the preview screen.



REMOVING CHROMATIC COLOURS FROM THE SCANNED ORIGINAL BEFORE TRANSMISSION (DROP OUT COLOUR)

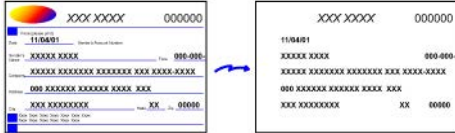

This function cannot be used in Internet fax mode.

1

Place the original.

Place the original in the document feeder tray of the automatic document feeder, or on the document glass.

- ▶ [AUTOMATIC DOCUMENT FEEDER \(page 1-84\)](#)
- ▶ [DOCUMENT GLASS \(page 1-86\)](#)

2

Tap the mode display to switch to the initial screen of each mode.

- ▶ [Changing mode from each mode \(page 5-10\)](#)

3

Specify the destination.

- ▶ [RETRIEVING A DESTINATION FROM AN ADDRESS BOOK \(page 5-16\)](#)
- ▶ [VIEWING A LIST OF THE SELECTED DESTINATIONS \(page 5-19\)](#)
- ▶ [USING A SEARCH NUMBER TO RETRIEVE A DESTINATION \(page 5-20\)](#)
- ▶ [ENTERING AN ADDRESS MANUALLY \(page 5-21\)](#)
- ▶ [SPECIFYING A NETWORK FOLDER \(page 5-22\)](#)
- ▶ [RETRIEVING A DESTINATION FROM A GLOBAL ADDRESS BOOK \(page 5-23\)](#)
- ▶ [USING A TRANSMISSION LOG TO RESEND \(page 5-25\)](#)

4

Tap the [Others] key, and then tap the [Drop Out colour] key.

A checkmark appears on the icon.

After the settings are completed, tap the [Back] key.



To cancel the drop out colour setting

Tap the [Drop Out colour] key to uncheck it.



5

Tap the [Start] key to start scanning of the original.

- If you inserted the original pages in the document feeder tray, all pages are scanned. A beep will sound to indicate that scanning and transmission have ended.
- When you place the original on the document glass, scan each page one at a time. When scanning finishes, place the next original and tap the [Start] key. Repeat the procedure until all pages have been scanned and then tap the [Read-End] key. A beep will sound to indicate that scanning and transmission have ended.



You can tap the [Preview] key to check a preview of the image before sending an image. For more information, see "[CHECKING THE IMAGE TO BE TRANSMITTED \(page 5-68\)](#)". Tap the [Change Setting] key in the scan-end confirmation screen to change the exposure, resolution, scan size, and send size. (However, when scanning each even-numbered page of the original, only the exposure can be changed.)



ADJUSTING RED/GREEN/BLUE (RGB Adjust)

This function heightens or lightens any one of the three colour components R (red), G (green), and B (blue).

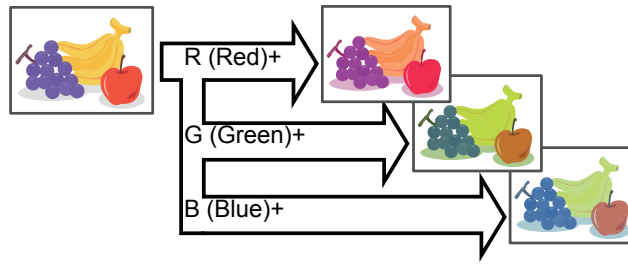

1

Place the original.

Place the original in the document feeder tray of the automatic document feeder, or on the document glass.

- ▶ [AUTOMATIC DOCUMENT FEEDER \(page 1-84\)](#)
- ▶ [DOCUMENT GLASS \(page 1-86\)](#)

2

Tap the mode display to switch to the initial screen of each mode.

- ▶ [Changing mode from each mode \(page 5-10\)](#)

3

Specify the destination.

- ▶ [RETRIEVING A DESTINATION FROM AN ADDRESS BOOK \(page 5-16\)](#)
- ▶ [VIEWING A LIST OF THE SELECTED DESTINATIONS \(page 5-19\)](#)
- ▶ [USING A SEARCH NUMBER TO RETRIEVE A DESTINATION \(page 5-20\)](#)
- ▶ [ENTERING AN ADDRESS MANUALLY \(page 5-21\)](#)
- ▶ [SPECIFYING A NETWORK FOLDER \(page 5-22\)](#)
- ▶ [RETRIEVING A DESTINATION FROM A GLOBAL ADDRESS BOOK \(page 5-23\)](#)
- ▶ [USING A TRANSMISSION LOG TO RESEND \(page 5-25\)](#)

4

Tap the [Others] key, and tap the [RGB Adjust] key.

5

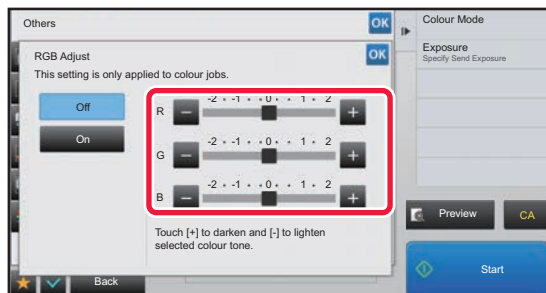

Tap **− +** of the colour you want to adjust or slide the slider to adjust the colouring.

After the settings are completed, tap **OK** and [Back] keys in sequence.



To cancel the RGB Adjust setting:

Tap the [Off] key.



6

Tap the [Start] key to start scanning of the original.

- If you inserted the original pages in the document feeder tray, all pages are scanned. A beep will sound to indicate that scanning and transmission have ended.
- When you place the original on the document glass, scan each page one at a time. When scanning finishes, place the next original and tap the [Start] key. Repeat the procedure until all pages have been scanned and then tap the [Read-End] key. A beep will sound to indicate that scanning and transmission have ended.



You can tap the [Preview] key to check a preview of the image before sending an image. For more information, see "[CHECKING THE IMAGE TO BE TRANSMITTED \(page 5-68\)](#)". Tap the [Change Setting] key in the scan-end confirmation screen to change the exposure, resolution, scan size, and send size. (However, when scanning each even-numbered page of the original, only the exposure can be changed.)



SCANNING ORIGINALS

ERASING PERIPHERAL SHADOWS ON THE IMAGE (ERASE)

When scanning thick originals or books, erase any peripheral shadows that may be produced on the image.

Scanning a thick book

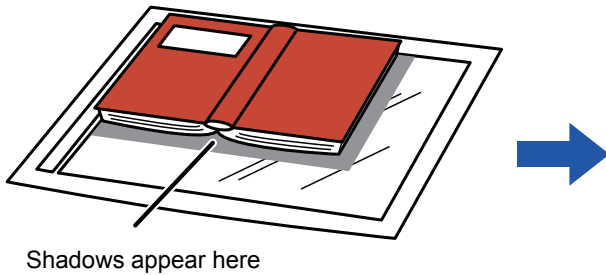

Not using the erase function	Using the erase function
Shadows appear in the image.	No shadows appear.

Erase modes

Outer Frame Erase

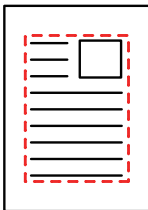

Centre Erase

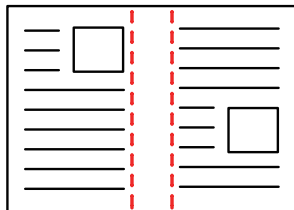

Edge + Centre Erase

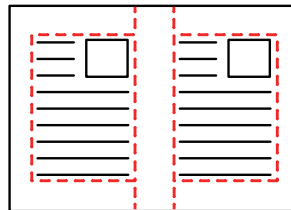

Side Erase

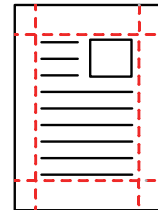

- This function erases the parts of the image where shadows tend to form, but does not detect shadows and erase only the shadows.
- If a ratio setting is used in combination with an erase setting, the erase width will change according to the selected ratio. For example, if you set an erase width of 10 mm (1/2") and reduce the image to 70% before scanning it, the erase width will be reduced to 7 mm (3/8").
- When the erase setting is selected, the image orientation will be forcibly portrait.



To change the default erase width setting:

In "Settings (administrator)", select [System Settings] → [Image Send Settings] → [Common Settings] → [Condition Settings] → [Erase Width Adjustment].

The width can be set from 0 mm to 20 mm (0" to 1"). The factory default setting is 10 mm (1/2"). The setting changed here will apply to [System Settings] → [Copy Settings] → [Condition Settings] → [Erase Width Adjustment] in "Settings".



1

Place the original.

Place the original in the document feeder tray of the automatic document feeder, or on the document glass.

- ▶ [AUTOMATIC DOCUMENT FEEDER \(page 1-84\)](#)
- ▶ [DOCUMENT GLASS \(page 1-86\)](#)

2

Tap the mode display to switch to the initial screen of each mode.

- ▶ [Changing mode from each mode \(page 5-10\)](#)

3

Specify the destination.

- ▶ [RETRIEVING A DESTINATION FROM AN ADDRESS BOOK \(page 5-16\)](#)
- ▶ [VIEWING A LIST OF THE SELECTED DESTINATIONS \(page 5-19\)](#)
- ▶ [USING A SEARCH NUMBER TO RETRIEVE A DESTINATION \(page 5-20\)](#)
- ▶ [ENTERING AN ADDRESS MANUALLY \(page 5-21\)](#)
- ▶ [SPECIFYING A NETWORK FOLDER \(page 5-22\)](#)
- ▶ [RETRIEVING A DESTINATION FROM A GLOBAL ADDRESS BOOK \(page 5-23\)](#)
- ▶ [USING A TRANSMISSION LOG TO RESEND \(page 5-25\)](#)

4

Tap the [Others] key, and tap the [Erase] key.

5

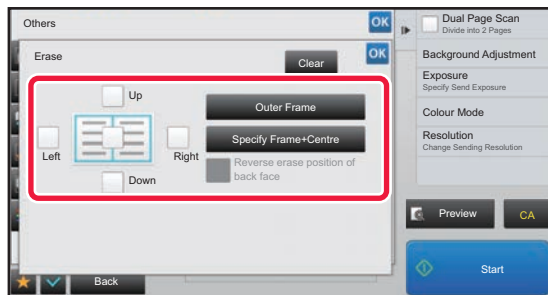
**Tap the checkbox of the edge that you wish to erase, and specify the erase position.**

Check that the tapped checkbox is set to .

If the [Specify Frame] key is tapped, the [Up], [Down], [Left], and [Right] checkboxes are set to .

If the [Specify Frame+Centre] key is tapped, all the checkboxes are set to .



Specify the erase edge on the reverse side when erasing edges of one to three sides of Up, Down, Left, and Right on the front side to scan a 2-sided original.

- If the [Reverse Erase Position of The Back Face] checkbox is set to , the edge in the position opposite to the erased edge on the front side will be erased.
- If the [Reverse Erase Position of The Back Face] checkbox is set to , the edge in the same position as on the front side will be erased.





6

Specify the erase width.

After the settings are completed, tap  and [Back] keys in sequence.



- Tap the numeric value display indicating the margin shift area on the front side or reverse side, and enter the area using the numeric keys.
- To quickly set the area, first specify a value close to the desired value by the numeric keys, then adjust it with  .



To cancel the erase setting:

Tap the [Clear] key.

7

Tap the [Start] key to start scanning of the original.

- If you inserted the original pages in the document feeder tray, all pages are scanned. A beep will sound to indicate that scanning and transmission have ended.
- When you place the original on the document glass, scan each page one at a time. When scanning finishes, place the next original and tap the [Start] key. Repeat until all pages have been scanned and then tap the [Read-End] key. A beep will sound to indicate that transmission has ended.



You can tap the [Preview] key to check a preview of the image before sending an image. For more information, see "[CHECKING THE IMAGE TO BE TRANSMITTED \(page 5-68\)](#)".



SCANNING A THIN ORIGINAL (SLOW SCAN MODE)

Use this function when you wish to scan thin originals using the automatic document feeder. This function helps prevent thin originals from misfeeding.

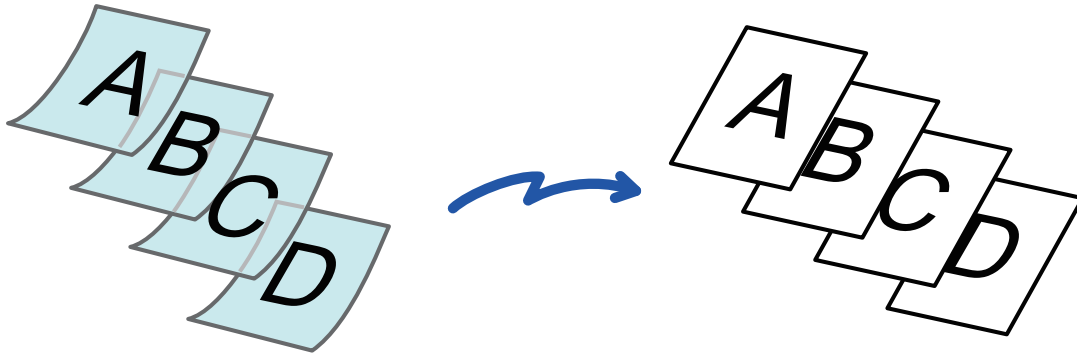

When slow scan mode is selected, 2-sided scanning is not possible.

1

Place the original in the document feeder tray of the automatic document feeder.

Adjust the original guides slowly.

- ▶ [AUTOMATIC DOCUMENT FEEDER \(page 1-84\)](#)



If the originals are inserted with too much force, they may crumple and misfeed.

2

Tap the mode display to switch to the initial screen of each mode.

- ▶ [Changing mode from each mode \(page 5-10\)](#)

3

Specify the destination.

- ▶ [RETRIEVING A DESTINATION FROM AN ADDRESS BOOK \(page 5-16\)](#)
- ▶ [VIEWING A LIST OF THE SELECTED DESTINATIONS \(page 5-19\)](#)
- ▶ [USING A SEARCH NUMBER TO RETRIEVE A DESTINATION \(page 5-20\)](#)
- ▶ [ENTERING AN ADDRESS MANUALLY \(page 5-21\)](#)
- ▶ [SPECIFYING A NETWORK FOLDER \(page 5-22\)](#)
- ▶ [RETRIEVING A DESTINATION FROM A GLOBAL ADDRESS BOOK \(page 5-23\)](#)
- ▶ [USING A TRANSMISSION LOG TO RESEND \(page 5-25\)](#)



4

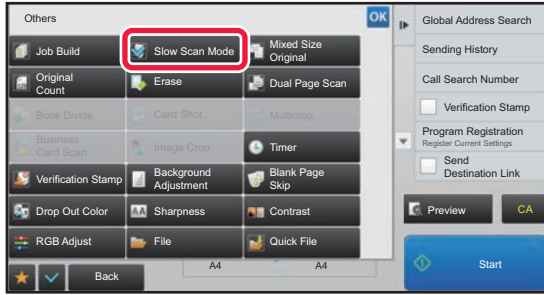

Tap the [Others] key, and tap the [Slow Scan Mode] key.

A checkmark appears on the icon.

After the settings are completed, tap the [Back] key.



To cancel the slow scan Mode setting

Tap the [Slow Scan Mode] key to uncheck it.

5

Tap the [Start] key to start scanning of the original.

A beep will sound to indicate that scanning and transmission have ended.



Tap the [Preview] key to check the preview of an image before sending a fax. For more information, see "[CHECKING THE IMAGE TO BE TRANSMITTED \(page 5-68\)](#)". However, settings for this function cannot be changed in the preview screen.



ELIMINATING BLANK PAGES FROM A TRANSMISSION (BLANK PAGE SKIP)

If the scanned original contains blank pages, this function skips them to send only non-blank pages. The machine detects blank pages, enabling you to skip useless blank sheets without checking an original.

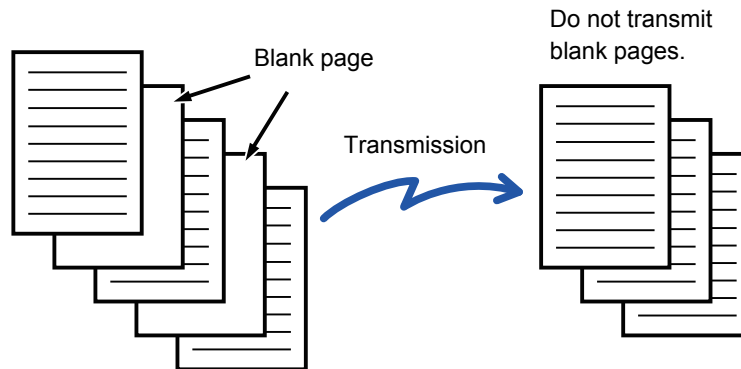

- If an original of which one side is blank is scanned, blank pages are skipped for 2-sided sending.
- In a broadcast transmission to destinations including fax and Internet fax destinations, this function is applied to scan mode destinations only.
- Depending on the original, some pages that are not blank may be detected as blank pages and thus not being sent, and some pages that are blank may not be detected as blank and thus sent.



- This function cannot be used in Internet fax mode.
- If the [Send Same Image as Fax Address] key is tapped, this function is cancelled if a fax address is specified for the destination.

1

Place the original.

Place the original in the document feeder tray of the automatic document feeder, or on the document glass.

- ▶ [AUTOMATIC DOCUMENT FEEDER \(page 1-84\)](#)
- ▶ [DOCUMENT GLASS \(page 1-86\)](#)

2

Tap the mode display to switch to the initial screen of each mode.

- ▶ [Changing mode from each mode \(page 5-10\)](#)

3

Specify the destination.

- ▶ [RETRIEVING A DESTINATION FROM AN ADDRESS BOOK \(page 5-16\)](#)
- ▶ [VIEWING A LIST OF THE SELECTED DESTINATIONS \(page 5-19\)](#)
- ▶ [USING A SEARCH NUMBER TO RETRIEVE A DESTINATION \(page 5-20\)](#)
- ▶ [ENTERING AN ADDRESS MANUALLY \(page 5-21\)](#)
- ▶ [SPECIFYING A NETWORK FOLDER \(page 5-22\)](#)
- ▶ [RETRIEVING A DESTINATION FROM A GLOBAL ADDRESS BOOK \(page 5-23\)](#)
- ▶ [USING A TRANSMISSION LOG TO RESEND \(page 5-25\)](#)



4

Tap the [Others] key, and tap the [Blank Page Skip] key.

5

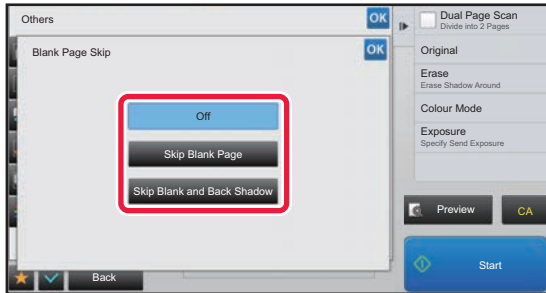

Tap the [Skip Blank Page] or [Skip Blank and Back Shadow] key.

After the settings are completed, tap **OK** and [Back] keys in sequence.



To cancel the Blank Page Skip setting:
Tap the [Off] key.

6

Tap the [Start] key to start scanning of the original.

A beep will sound to indicate that scanning has ended.



Tap the [Preview] key to check the preview of an image before sending a fax. For more information, see "[CHECKING THE IMAGE TO BE TRANSMITTED \(page 5-68\)](#)".

7

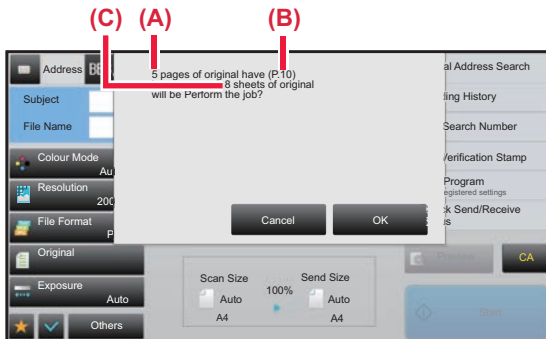

When scanning ends, check the number of original sheets and the number of sheets to be sent and tap the [OK] key to start transmission.

- When Job Build mode is used, the confirmation message will appear after the [Start] key is tapped.
- On the confirmation screen, the number of scanned original sheets appears in (A), the number of scanned sides in (B), and the number of sheets to be sent excluding blank pages in (C).

For example, if five original sheets that include two blank pages are scanned by duplex scanning, (A) will show "5", (B) will show "10", and (C) will show "8".



If this step is not performed within one minute after the above confirmation screen appears, the scanned image and settings will be cleared and the base screen will reappear. Scanning will not be completed automatically and the image will not be reserved for transmission.



CHECKING THE NUMBER OF SCANNED ORIGINAL SHEETS BEFORE TRANSMISSION (ORIGINAL COUNT)

Count the number of scanned original sheets and display the count before transmission.

Checking the number of scanned original sheets before transmission helps prevent transmission mistakes.



- The count result is displayed with the number of scanned original sheets, not the number of scanned original pages. For example, when a 2-sided original is transmitted, the number "1" will appear to indicate that one original sheet is transmitted, not "2" to indicate the front-side page and the reverse side page.
- When a broadcast transmission is performed, if the original count function is selected in any of the modes, the function will operate for all destinations.
- The setting should be enabled separately for each mode.

1

Place originals in the automatic document feeder.

- [AUTOMATIC DOCUMENT FEEDER \(page 1-84\)](#)

2

Tap the mode display to switch to the initial screen of each mode.

- [Changing mode from each mode \(page 5-10\)](#)

3

Specify the destination.

- [RETRIEVING A DESTINATION FROM AN ADDRESS BOOK \(page 5-16\)](#)
- [VIEWING A LIST OF THE SELECTED DESTINATIONS \(page 5-19\)](#)
- [USING A SEARCH NUMBER TO RETRIEVE A DESTINATION \(page 5-20\)](#)
- [ENTERING AN ADDRESS MANUALLY \(page 5-21\)](#)
- [SPECIFYING A NETWORK FOLDER \(page 5-22\)](#)
- [RETRIEVING A DESTINATION FROM A GLOBAL ADDRESS BOOK \(page 5-23\)](#)
- [USING A TRANSMISSION LOG TO RESEND \(page 5-25\)](#)

4

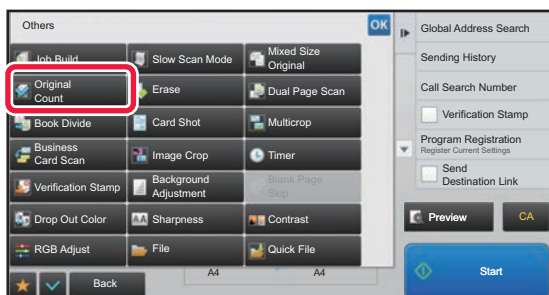

Tap the [Others] key, and tap the [Original Count] key.

A checkmark appears on the icon.

After the settings are completed, tap the [Back] key.



To cancel the original count setting:

Tap the [Original Count] key to uncheck it.



5

Tap the [Start] key to start scanning of the original.

A beep will sound to indicate that scanning has ended.



Tap the [Preview] key to check the preview of an image before sending a fax. For more information, see "[CHECKING THE IMAGE TO BE TRANSMITTED \(page 5-68\)](#)". However, settings for this function cannot be changed in the preview screen.

6

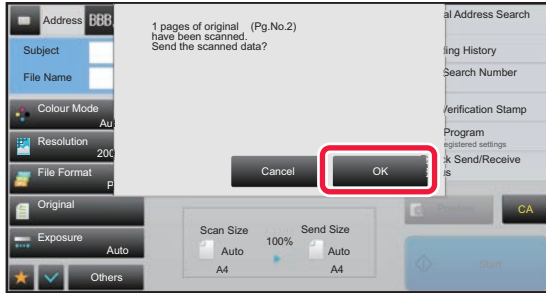

Check the number of original sheets.

The number that is displayed is the number of scanned original sheets, not the number of scanned original pages. For example, when 2-sided copying is performed using one original, the number "1" will appear to indicate that one original sheet was scanned, not "2" to indicate the front-side page and the reverse side page.

7

Tap the [OK] key to start transmission.



If this function is combined with [Job Build], the count result is displayed after the [Read-End] key has been tapped. If this step is not performed within one minute after the above confirmation screen appears, the scanned image and settings will be cleared and the base screen will reappear. Scanning will not be completed automatically and the image will not be reserved for transmission.



If the displayed number of original sheets is different from the actual number of sheets:

Tap the [Cancel] key and then tap the [OK] key in the message screen to clear all scanned data. Scan settings and destination settings will not be cleared. Insert the original sheets in the document feeder tray again and tap the [Start] key to re-scan.



STAMPING SCANNED ORIGINALS (VERIFICATION STAMP)

This function stamps each original that is scanned using the automatic document feeder, allowing you to verify that all originals were correctly scanned.

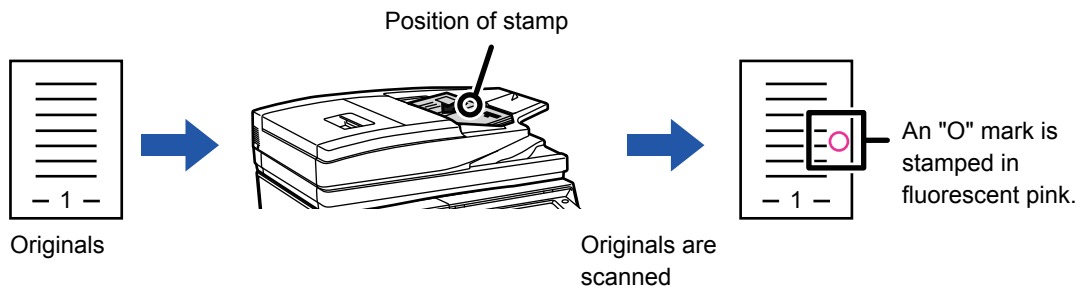

- To use the verification stamp function, the optional stamp unit must be installed.
- When 2-sided originals are used, the front of each original is stamped twice.
- If an error occurs during scanning, an original that was not scanned may be stamped.
- When the "O" mark that is stamped on originals starts to become faint, replace the stamp cartridge.
For the procedure for replacing the stamp cartridge, see "[REPLACING THE STAMP CARTRIDGE \(page 1-162\)](#)".



1

Place originals in the automatic document feeder.

- ▶ [AUTOMATIC DOCUMENT FEEDER \(page 1-84\)](#)

2

Tap the mode display to switch to the initial screen of each mode.

- ▶ [Changing mode from each mode \(page 5-10\)](#)

3

Specify the destination.

- ▶ [RETRIEVING A DESTINATION FROM AN ADDRESS BOOK \(page 5-16\)](#)
- ▶ [VIEWING A LIST OF THE SELECTED DESTINATIONS \(page 5-19\)](#)
- ▶ [USING A SEARCH NUMBER TO RETRIEVE A DESTINATION \(page 5-20\)](#)
- ▶ [ENTERING AN ADDRESS MANUALLY \(page 5-21\)](#)
- ▶ [SPECIFYING A NETWORK FOLDER \(page 5-22\)](#)
- ▶ [RETRIEVING A DESTINATION FROM A GLOBAL ADDRESS BOOK \(page 5-23\)](#)
- ▶ [USING A TRANSMISSION LOG TO RESEND \(page 5-25\)](#)

4

Tap [Verification Stamp] on the action panel or [Others] key, and tap the [Verif. Stamp] key.

The appropriate icon or checkbox is selected.

If you tap the [Others] key, tap the [Back] key after the settings have been completed.



To cancel the verification stamp setting:

Tap [Verification Stamp] on the action panel or the [Others] key, and tap [Verif. Stamp] to clear the checkmark.

5

Tap the [Start] key to start scanning of the original.

A beep will sound to indicate that scanning and transmission have ended.



Tap the [Preview] key to check the preview of an image before sending a fax. For more information, see "[CHECKING THE IMAGE TO BE TRANSMITTED \(page 5-68\)](#)". However, settings for this function cannot be changed in the preview screen.



SPECIFIC FUNCTIONS

ADDING YOUR SENDER INFORMATION TO FAXES (I-FAX OWN ADDRESS SEND)

Your sender information (date, time, sender name, sender address, number of pages) is automatically added to the top of the file you transmit.



This function cannot be used in scan mode or data entry mode.

Example of the sender information printed

- (1) Date, time: The date and time of transmission.
- (2) Sender name: The sender name programmed in the machine.
- (3) Source Address.
- (4) Page numbers: Page number/total pages.

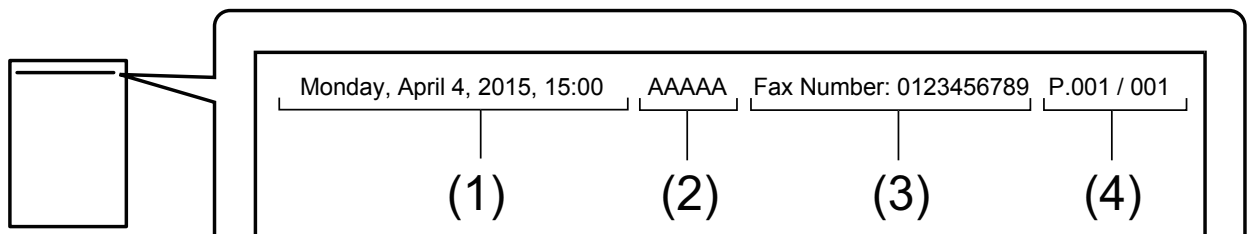

- Storing and setting sender information

Date, time: In "Settings", select [System Settings] → [Common Settings] → [Clock Adjust].

Sender name, sender address: In "Settings (administrator)", select [System Settings] → [Image Send Settings] → [Common Settings] → [Own Number and Name Set] → [Sender Data Registration]. If you intend to use the I-Fax Own Address Send function, be sure to configure this information.

Page numbers: Select whether or not to include page numbers using [System Settings] → [Image Send Settings] → [Internet Fax Settings] → [Send Setting] → [Printing Page Number at Receiver] in "Settings (administrator)".

- Position of sender information

The sender information is printed at the top of the scanned image data. This makes the transmission data longer than the scan size, so it may be reduced or divided onto two pages when printed by the receiving machine.



CHANGING THE PRINT SETTINGS FOR THE TRANSACTION REPORT (TRANSACTION REPORT)

A transaction report is automatically printed out to alert you when an Internet fax transmission fails or when a broadcast transmission is performed.

The transaction report contains a description of the transmission (date, start time, name of destination, time required, number of pages, result, etc.).

► [INFORMATION APPEARING IN THE RESULT COLUMN \(page 5-132\)](#)

Transaction reports are printed based on conditions set in the setting mode. Select different conditions for a transmission as required.



This function cannot be used in scan mode or data entry mode.



For a broadcast transmission, changes to the transaction report print conditions apply to all destinations.

1

Place the original.

Place the original in the document feeder tray of the automatic document feeder, or on the document glass.

- [AUTOMATIC DOCUMENT FEEDER \(page 1-84\)](#)
- [DOCUMENT GLASS \(page 1-86\)](#)

2

Tap the mode display to switch to the initial screen of Internet Fax mode.

- [Changing mode from each mode \(page 5-10\)](#)

3

Specify the destination.

- [RETRIEVING A DESTINATION FROM AN ADDRESS BOOK \(page 5-16\)](#)
- [VIEWING A LIST OF THE SELECTED DESTINATIONS \(page 5-19\)](#)
- [USING A SEARCH NUMBER TO RETRIEVE A DESTINATION \(page 5-20\)](#)
- [ENTERING AN ADDRESS MANUALLY \(page 5-21\)](#)
- [SPECIFYING A NETWORK FOLDER \(page 5-22\)](#)
- [RETRIEVING A DESTINATION FROM A GLOBAL ADDRESS BOOK \(page 5-23\)](#)
- [USING A TRANSMISSION LOG TO RESEND \(page 5-25\)](#)

4

Tap the [Others] key, and tap the [Transaction Report] key.

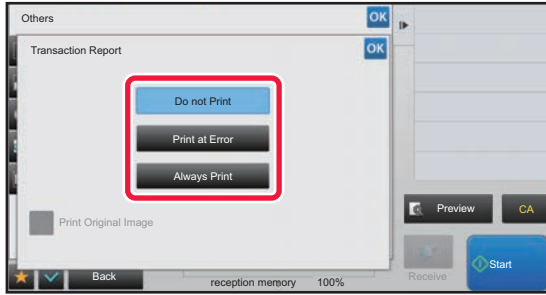

5

**Tap the key of the print settings.**

After the settings are completed, tap **OK** and [Back] keys in sequence.

**To cancel the transaction report settings:**

Tap the [Do not Print] key.



• The print conditions for a transaction report are as follows:

- "Always Print": A transaction report is printed no matter whether the transmission succeeds or fails.
- "Print at Error": A transaction report is printed when transmission fails.
- "Do not Print": Do not print a transaction report.
- Set the [Print Original Image] checkbox to to include part of the transmitted original in the transaction report.

6

Tap the [Start] key to start scanning of the original.

- If you inserted the original pages in the document feeder tray, all pages are scanned. A beep will sound to indicate that scanning and transmission have ended.
- When you place the original on the document glass, scan each page one at a time. When scanning finishes, place the next original and tap the [Start] key. Repeat the procedure until all pages have been scanned and then tap the [Read-End] key. A beep will sound to indicate that scanning and transmission have ended.



You can tap the [Preview] key to check a preview of the image before sending an image. For more information, see "[CHECKING THE IMAGE TO BE TRANSMITTED \(page 5-68\)](#)".

Original image in transaction report

When [Print Original Image] is enabled, the first page of the transmitted original is printed on the same sheet as the transaction report. The original image is reduced to allow it to fit on the sheet. If the vertical scanning length (X direction) of the original is longer than 432 mm (17-1/64"), the part that exceeds 432 mm (17-1/64") may be cut off.



STARTING A TRANSMISSION AT A SPECIFIED TIME (TIMER TRANSMISSION)

Specify a time at which a transmission or broadcast transmission will automatically take place. Transmission begins automatically at the specified time.

This function is helpful when you wish to perform reserved, broadcast or other transmissions during your absence or at night or other times when telephone rates are low.

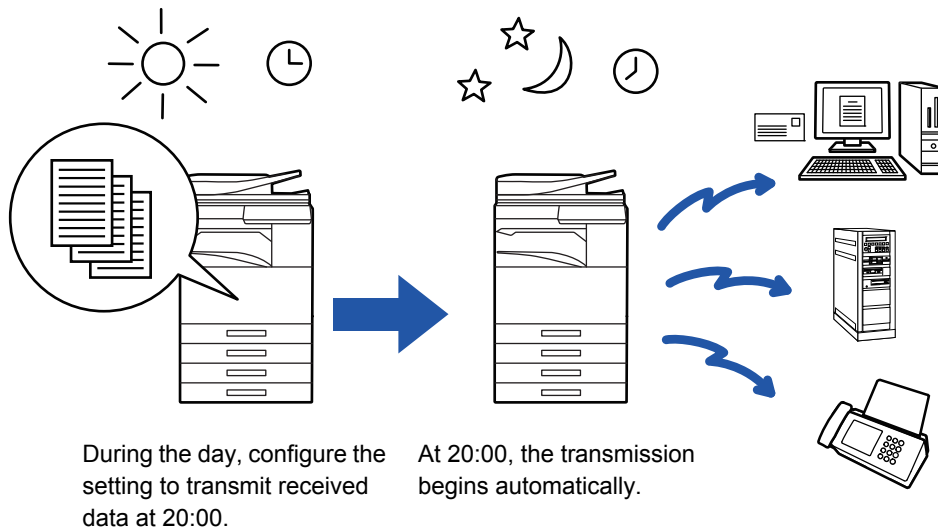

- When a timer transmission is set, keep the main power switch in the " | " position. If the main power switch is in the " ⏻ " position at the specified time, transmission will not take place.
- When performing a timer transmission, you must scan the original into memory when you set up the transmission. It is not possible to leave the document in the document feeder tray or on the document glass and have it scanned at the reserved time of transmission.
- Up to 100 timer transmissions can be stored at once.



- Settings selected for a timer transmission (exposure, resolution, and other functions) are automatically cleared after the transmission is finished. (However, when the document filing function is used, the scanned original image and settings are stored in the built-in hard drive.)
- If another transmission is in progress when the specified time arrives, the timer transmission will begin after that transmission is finished.
- If a job scheduled for timer transmission is given priority on the job status screen, the timer will be cancelled. The transmission will begin as soon as the job in progress is completed.
 - ▶ [PRIORITY PROCESSING OF A RESERVED JOB \(page 1-91\)](#)
- The time can be specified up to a week in advance.
- After the timer transmission settings are specified, start the transmission in the same way as other functions.
- A timer transmission can be deleted in the job status screen.

1

Place the original.

Place the original in the document feeder tray of the automatic document feeder, or on the document glass.

- ▶ [AUTOMATIC DOCUMENT FEEDER \(page 1-84\)](#)
- ▶ [DOCUMENT GLASS \(page 1-86\)](#)

2

Tap the mode display to switch to the initial screen of each mode.

- ▶ [Changing mode from each mode \(page 5-10\)](#)



3

Specify the destination.

- ▶ [RETRIEVING A DESTINATION FROM AN ADDRESS BOOK \(page 5-16\)](#)
- ▶ [VIEWING A LIST OF THE SELECTED DESTINATIONS \(page 5-19\)](#)
- ▶ [USING A SEARCH NUMBER TO RETRIEVE A DESTINATION \(page 5-20\)](#)
- ▶ [ENTERING AN ADDRESS MANUALLY \(page 5-21\)](#)
- ▶ [SPECIFYING A NETWORK FOLDER \(page 5-22\)](#)
- ▶ [RETRIEVING A DESTINATION FROM A GLOBAL ADDRESS BOOK \(page 5-23\)](#)
- ▶ [USING A TRANSMISSION LOG TO RESEND \(page 5-25\)](#)

4

Tap the [Others] key, and tap the [Timer] key.

5

Tap [On] key.

6

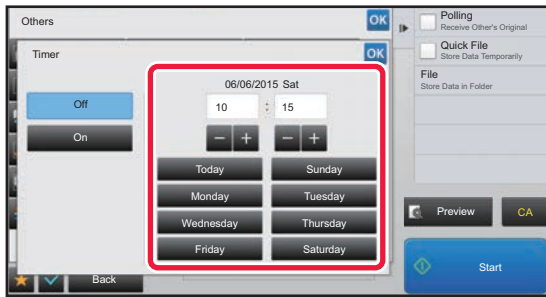

Specify the date.

7

Specify the time (hour and minute) in 24-hour format.

After the settings are completed, tap **OK** and [Back] keys in sequence.



- Tap the areas displaying the hour and minute respectively, and enter the values using the numeric keys.
- It is convenient to use **- +** to finely adjust the time.
- The setting will show the current time. If the time is not correct, press the [CA] key to cancel the operation. Correct the time in setting mode and then perform the timer transmission procedure.
 - ▶ [BEFORE USING THE MACHINE AS A NETWORK SCANNER FUNCTION \(page 5-4\)](#)



To cancel the Timer Transmission settings:

Tap the [Off] key.



To set the date and time of the machine:

In "Settings", select [System Settings] → [Common Settings] → [Clock Adjust].
 If [Disabling of Clock Adjustment] has been enabled, the date and time cannot be modified. Select [System Settings] in "Settings (administrator)" and select [System Settings] → [Common Settings] → [Enable/Disable Settings] to disable the [Disabling of Clock Adjustment] setting.



8

Tap the [Start] key to start scanning of the original.

- If you inserted the original pages in the document feeder tray, all pages are scanned. A beep will sound to indicate that scanning has ended, and the machine stands by for transmission.
- When you place the original on the document glass, scan each page one at a time. When scanning finishes, place the next original and tap the [Start] key. Repeat until all pages have been scanned and then tap the [Read-End] key. A beep will sound to indicate that scanning has ended, and the machine stands by for transmission.



You can tap the [Preview] key to check a preview of the image before sending an image. For more information, see "[CHECKING THE IMAGE TO BE TRANSMITTED \(page 5-68\)](#)".



The original is scanned into memory. The original cannot be scanned at a specified time.



ADDING A SIGNATURE WHEN SENDING AN IMAGE (ELECTRONIC SIGNATURE)

You can add a signature when sending a scanned image. This allows the recipient to check your sender information in the electronic signature.



This function is available for Scan to E-mail.



To add an electronic signature to a scanned image

- In "Settings (administrator)", select [System Settings] → [Security Settings] → [S/MIME Settings] → [Condition Settings].
- When [Select at Sending] is selected in "Sign E-mail" in "Settings (administrator)", you can specify whether or not an electronic signature is added each time you send an image. When [Always Enable] is selected, the setting cannot be changed.

1

Place the original.

Place the original in the document feeder tray of the automatic document feeder, or on the document glass.

- ▶ [AUTOMATIC DOCUMENT FEEDER \(page 1-84\)](#)
- ▶ [DOCUMENT GLASS \(page 1-86\)](#)

2

Tap the mode display to switch to the initial screen of E-mail mode.

- ▶ [Changing mode from each mode \(page 5-10\)](#)

3

Specify the destination.

- ▶ [RETRIEVING A DESTINATION FROM AN ADDRESS BOOK \(page 5-16\)](#)
- ▶ [VIEWING A LIST OF THE SELECTED DESTINATIONS \(page 5-19\)](#)
- ▶ [USING A SEARCH NUMBER TO RETRIEVE A DESTINATION \(page 5-20\)](#)
- ▶ [ENTERING AN ADDRESS MANUALLY \(page 5-21\)](#)
- ▶ [SPECIFYING A NETWORK FOLDER \(page 5-22\)](#)
- ▶ [RETRIEVING A DESTINATION FROM A GLOBAL ADDRESS BOOK \(page 5-23\)](#)
- ▶ [USING A TRANSMISSION LOG TO RESEND \(page 5-25\)](#)

4

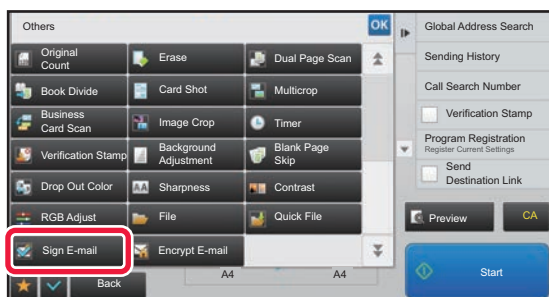

Tap the [Others] key, and tap the [Sign E-mail] key.

A checkmark appears on the icon.

After the settings are completed, tap the [Back] key.



To cancel the sign E-mail setting

Tap the [Sign E-mail] key to uncheck it.



5

Tap the [Start] key to start scanning of the original.

- If you inserted the original pages in the document feeder tray, all pages are scanned. A beep will sound to indicate that scanning and transmission have ended.
- When you place the original on the document glass, scan each page one at a time. When scanning finishes, place the next original and tap the [Start] key. Repeat the procedure until all pages have been scanned and then tap the [Read-End] key. A beep will sound to indicate that scanning and transmission have ended.



You can tap the [Preview] key to check a preview of the image before sending an image. For more information, see "[CHECKING THE IMAGE TO BE TRANSMITTED \(page 5-68\)](#)".



ENCRYPTING THE TRANSMITTED DATA (ENCRYPTION)

You can encrypt the transmitted data to strengthen security.



This function is available for Scan to E-mail.



To encrypt transmitted data

- In "Settings (administrator)", select [System Settings] → [Security Settings] → [S/MIME Settings] → [Condition Settings].
- When [Select at Sending] is selected in "Encrypt E-mail" in "Settings (administrator)", you can specify whether or not the data is encrypted each time you send an image. When [Always Enable] is selected, the setting cannot be changed.

1

Place the original.

Place the original in the document feeder tray of the automatic document feeder, or on the document glass.

- ▶ [AUTOMATIC DOCUMENT FEEDER \(page 1-84\)](#)
- ▶ [DOCUMENT GLASS \(page 1-86\)](#)

2

Tap the mode display to switch to the initial screen of E-mail mode.

- ▶ [Changing mode from each mode \(page 5-10\)](#)

3

Specify the destination.

- ▶ [RETRIEVING A DESTINATION FROM AN ADDRESS BOOK \(page 5-16\)](#)
- ▶ [VIEWING A LIST OF THE SELECTED DESTINATIONS \(page 5-19\)](#)
- ▶ [USING A SEARCH NUMBER TO RETRIEVE A DESTINATION \(page 5-20\)](#)
- ▶ [RETRIEVING A DESTINATION FROM A GLOBAL ADDRESS BOOK \(page 5-23\)](#)



- Data encryption is not possible when the address is directly entered.
- Encrypted data can only be sent to an address for which you have registered a user certificate. Register a user certificate for the address in "Settings (Web version)" - [Address Book] → [E-mail] → "User Certificate". Only one E-mail address can be registered for an address that has a user certificate.
- If the "Disable sending to the addresses which cannot be encrypted." checkbox is () in "Settings (administrator)" - [System Settings] → [Security Settings] → [S/MIME Settings] → [Condition Settings] → [Encryption Settings], addresses without a user certificate cannot be selected. When the checkmark is removed () , the data is sent without encryption.

4

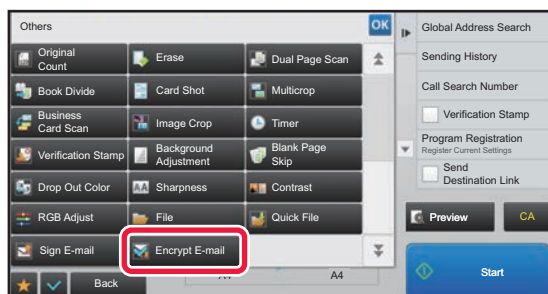

Tap the [Others] key, and tap the [Encrypt E-mail] key.

A checkmark appears on the icon.

After the settings are completed, tap the [Back] key.



To cancel the encryption setting

Tap the [Encrypt E-mail] key to remove the checkmark.



5

Tap the [Start] key to start scanning of the original.

- If you inserted the original pages in the document feeder tray, all pages are scanned. A beep will sound to indicate that scanning and transmission have ended.
- When you place the original on the document glass, scan each page one at a time. When scanning finishes, place the next original and tap the [Start] key. Repeat the procedure until all pages have been scanned and then tap the [Read-End] key. A beep will sound to indicate that scanning and transmission have ended.



You can tap the [Preview] key to check a preview of the image before sending an image. For more information, see "[CHECKING THE IMAGE TO BE TRANSMITTED \(page 5-68\)](#)".



SENDING A SCANNED DOCUMENT BY GMAIL OR EXCHANGE

You can send e-mail from the machine using Gmail or Exchange.

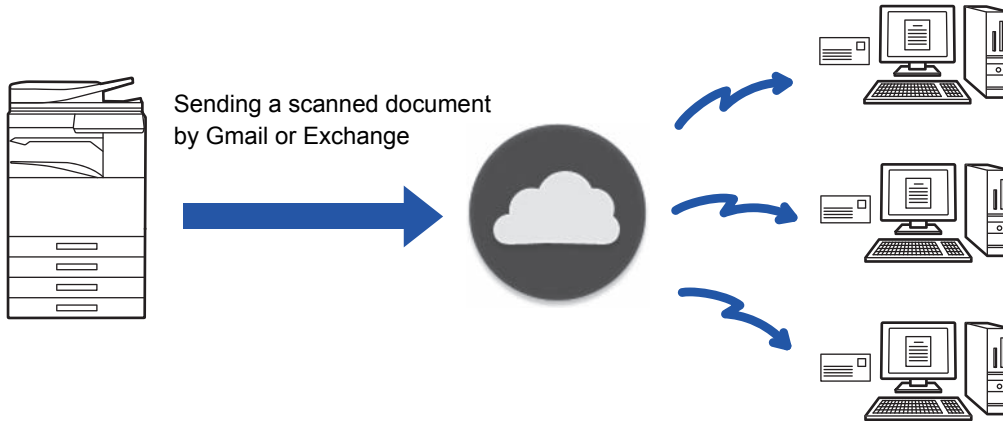

EMAIL LINK FUNCTION

Gmail Connector is a function for sending scanned documents by e-mail via the Gmail server using a Google account. To use Gmail Connector, you must log in using an account that has a Gmail address in the format "****@Gmail.com".

Before using Gmail link function

This section explains settings that must be configured before you can use Gmail link function.

Settings required on the machine

System settings

Enable the "Gmail" setting in "Settings (Administrator)" → [System Settings] → [Network Settings] → [External Service Connect] → [E-mail Connect Settings].

Add the Gmail icon to the home screen

1

Tap [Edit Home] on the action panel.

2

In home edit mode, tap an unused shortcut key.

3

Tap the [Gmail] key.



4

Tap [Exit Home Edit Mode] on the action panel.

You will exit home edit mode and return to the home screen.



To edit the home screen, refer to "UI Customize Guide".

Sending a scanned document by Gmail link function

The steps for scanning a document on the machine and sending the scanned image by Gmail are explained below.

1

Tap the [Gmail] key in the home screen.

The Gmail login screen appears.

2

Enter your Google account information.

The settings screen appears.

3

Select the address of the recipient and scan settings.

For the address and scan settings, refer to "[SETTINGS SCREEN \(page 5-128\)](#)".

4

To view a preview of the scanned image, tap the [Preview] key.

5

Tap the [Start] key.

The sent e-mail is managed in "Sent Mail" of Gmail.



EXCHANGE LINK FUNCTION

Exchange link function is a function for sending scanned documents by e-mail using Exchange server and Exchange Online offered by Microsoft Corporation.

You can connect to "Microsoft Exchange Server 2010/2013" or "Exchange Online (Cloud Service)".

Before using Exchange link function

This section explains the settings that must be configured before you can use Exchange link function.

Settings required on the machine

System settings

To connect to Exchange Server:

Enter the host name (FQDN) of the Exchange server in "Hostname" of "Settings (Administrator)" → [System Settings] → [Network Settings] → [External Service Connect] → [E-mail Connect Settings] → [Exchange].

To connect to Exchange Online:

Select "Use Exchange Online" in Settings (administrator) - "System Settings" → "Network Settings" → "External Service Connect" → "E-mail Connect Settings" → "Exchange".

Add the Exchange Connector icon to the home screen

1

Tap [Edit Home] on the action panel.

2

In home edit mode, tap an unused shortcut key.

3

Tap the [Exchange (E-Mail)] key.

4

Tap [Exit Home Edit Mode] on the action panel.

Exit home edit mode and return to the home screen.



To edit the home screen, refer to "UI Customize Guide".



Sending a scanned document by Exchange

The steps for scanning a document on the machine and sending the scanned image by Exchange are explained below.

1

Tap the [Exchange (E-Mail)] key in the home screen.

The Exchange login screen appears.

2

Enter the user name and password used to connect to the Exchange server or the Exchange Online.

The settings screen appears.

3

Select the address of the recipient and scan settings.

For the address and scan settings, refer to "[SETTINGS SCREEN \(page 5-128\)](#)".

4

To view a preview of the scanned image, tap the [Preview] key.

5

Tap the [Start] key.

The sent e-mail is managed in "Sent Mail" of Exchange.



SETTINGS SCREEN

This section explains the settings screen of Gmail link function and Exchange link function. You can use this screen to enter recipient settings, the e-mail subject, a message, and the name of the file to be attached. You can also change the account used to log in and select advanced scan settings.

Recipient settings

Enter the desired recipient addresses in the To, Cc, and Bcc text boxes. To enter multiple addresses, separate the addresses by commas. You can also search for addresses in the address book.

Search screen

You can tap  next to the To, Cc, and Bcc text boxes to search for a saved address. Enter the text you want to find in the text box and tap [Search Start]. A list of the addresses that begin with the entered text will appear. You can select multiple addresses from the list. When searching for an address, you can switch between the regular address book and a global address book. To search again, enter the text you want to find in the text box and tap [Search Again].



Checking an address

You can tap the [Address List] key to show the list of addresses to be used. You can check the addresses in To, Cc, and Bcc. You can also remove addresses from the list. To remove an address, select the address and tap the [Delete] key.



When a contact is selected in the list, no additional contacts can be directly entered.



When an address is entered in To, Cc, or Bcc,  appears. To cancel all addresses that are displayed, tap .

Subject, message, and file name settings

Enter a subject for the e-mail, a message, and the file name of the scanned image to be attached.

Changing the login account

You can change the account currently used for login to a different account. Tap the [Switch Accounts] key to open the Gmail or Exchange login screen, and enter the user name and password of the account that you want to use.



Scan settings

To select advanced scan settings, tap the [Detail] key.

Details screen

The scan settings below can be selected.

Details and restrictions on each setting can be found on the indicated pages. Refer to these pages as needed.

Setting	Description	Page
Colour Mode	Auto, Mono ² , Greyscale, Full Colour	5-66
Resolution	100x100dpi, 150x150dpi, 200x200dpi, 300x300dpi, 400x400dpi, 600x600dpi	5-59
Format	<p>[Colour/Greyscale] tab</p> <p>Format PDF, Compact PDF^{*1}, Compact PDF (Ultra Fine)^{*1}, PDF/A-1a^{*2}, PDF/A-1b^{*2}, PDF/A^{*3}, Compact PDF/A-1a^{*2}, Compact PDF/A-1b^{*2}, Compact PDF/A^{*4, 5}, Compact PDF/A-1a (Ultra Fine)^{*2}, Compact PDF/A-1b (Ultra Fine)^{*2}, Compact PDF/A (Ultra Fine)^{*4, 5}, Encrypt PDF, Encrypt/Compact PDF^{*1}, Encrypt/Compact PDF (Ultra Fine)^{*1}, TIFF, JPEG, XPS, TXT(UTF-8)^{*2}, RTF^{*2}, DOCX^{*2}, XLSX^{*2}, PPTX^{*2}</p> <p>OCR Settings^{*2} Language Setting, Font, Detect Image Direction, File Name Auto Extraction, OCR Accuracy</p> <p>Compression Ratio Low, Middle, High, Bk Letter Emphasis</p> <p>[B/W] tab</p> <p>Format PDF, PDF/A-1a^{*2}, PDF/A-1b^{*2}, PDF/A^{*3}, Encrypt PDF, TIFF, XPS, TXT(UTF-8)^{*2}, RTF^{*2}, DOCX^{*2}, XLSX^{*2}, PPTX^{*2}</p> <p>OCR Settings^{*2} Language Setting, Font, Detect Image Direction, File Name Auto Extraction, OCR Accuracy</p> <p>Compression Mode None, MH (G3), MMR (G4)</p>	5-60
Original	<p>Scan Size Auto</p> <p>[AB] tab A5, A5R, B5, B5R, A4, A4R, B4, A3, 216 x 340, 216 x 343, Long Size</p> <p>[Inch] tab 5-1/2" x 8-1/2", 8-1/2" x 11"R, 11" x 17", 5-1/2" x 8-1/2"R, 8-1/2" x 13", 8-1/2" x 13-1/2", 8-1/2" x 11", 8-1/2" x 14", Long Size</p> <p>Image Orientation Portrait, Landscape</p> <p>Duplex Setup 1-Sided, Book, Tablet</p>	5-48
Job Build	Enabled, Disabled	5-86
Blank Page Skip	Off, Skip Blank Page, Skip Blank and Back Shadow	5-108

*1 On the MX-3050V/MX-3550V/MX-4050V/MX-5050V/MX-6050V, this only appears when the Enhanced compression kit is installed

*2 Only appears on the MX-3060V/MX-3070V/MX-3560V/MX-3570V/MX-4060V/MX-4070V/MX-5070V/MX-6070V

*3 Only appears on the MX-2630N/MX-3050V/MX-3550V/MX-4050V/MX-5050V/MX-6050V

*4 Only appears on the MX-3050V/MX-3550V/MX-4050V/MX-5050V/MX-6050V

*5 Only appears when the Enhanced compression kit is installed



- E-mail that is sent may be limited by the settings and specifications of the Gmail or Exchange server.
- In some network environments, the machine may not be able to use the Gmail or Exchange connection functions, or sending may be slow or may stop before the job is completed.
- Sharp Corporation does not in any way guarantee the continuity or stability of Gmail or Exchange connection functions. With the exception of instances provided for by law, Sharp Corporation bears no responsibility for any damages or loss due to the customer's use of these functions.



INTERNET FAX RECEPTION FUNCTIONS

CHECKING THE INTERNET FAX ACTIVITY LOG

PRINTING IMAGE SENDING ACTIVITY REPORTS

Print a log of recent image sending activities (date, name of destination, time required, result, and other items).

The Image Sending Activity Report contains information that is useful in dealing with problems, such as the types of errors that occurred.

The most recent 200 transactions are included in the report.

You can have the machine print the Image Sending Activity Report each time the number of transactions reaches 201, or at a specified time (once a day only).



The contents of the Image Sending Activity Report are erased when the report is printed, and thus it cannot be reprinted.



To configure the image sending activity report:

In "Settings", select [System Settings] → [Image Send Settings] → [Internet Fax Settings] → [Default Settings] → [Activity Report Print Select Setting].



INFORMATION APPEARING IN THE RESULT COLUMN

Error types and other information are printed in the result column of transaction and activity reports. When a transaction or activity report is printed, check the result of the transaction in the result column and take action as needed.

Examples of messages that are printed in the result column

Print Page	Description
OK	The transaction was completed normally.
Cancel	A transmission was stopped while in progress, or a reserved transmission job was cancelled.
FULL	The memory became full during reception.
Rejected	An Internet fax was sent from a party that is blocked.
Report Wait	Transmission confirmation was enabled, but transmission confirmation was not received within the set time.
NG LIMIT	Transmission was not possible because the file size exceeded the machine's file size limit setting.
E-mail	An e-mail was received, however, the attached file was not a TIFF-F file or there was no attached file, and thus printing was not possible.
FAIL xx (xxxx)	The transaction failed due to a communication error. First 2 digits of communication error number: Error code from 00 to 99. Last 4 digits of communication error number: Code for use by service technicians.
displayed*	Displayed at the receiving machine when delivery confirmation is set.
dispatched*	Forwarded elsewhere before being displayed at the receiving machine when delivery confirmation is set.
processed*	Processed without being displayed at receiving machine when delivery confirmation is set.
deleted*	Message deleted at receiving machine when delivery confirmation is set.
denied*	Receiving machine refused to notify sending machine of message processing content when delivery confirmation is set.
failed*	An abnormal condition occurred when delivery confirmation is set.

* If the receiving machine is a SHARP machine, the receiving machine will return "dispatched" if the fax was received normally, or "processed" if reception failed.

When delivery confirmation is set for Internet Fax, the disposition feeld value indicated on the delivery confirmation return e-mail appears.



RECEIVING INTERNET FAXES

RECEIVING INTERNET FAXES AUTOMATICALLY

The Internet fax function periodically connects to the mail server (POP3 server) and checks whether or not Internet faxes have been received. When faxes have been received, the faxes are automatically retrieved and printed. In the default setting, this function checks for reception once every five minutes.



- If faxes will be received at night, keep the main power switch of the machine in the " | " position.
- If the machine is out of paper or there is no paper that matches the size of the received fax, a message will appear in the touch panel. Follow the instructions in the message to load an appropriate size of paper.
- You can print the received Internet fax data at the specified time.
 - ▶ [PRINTING RECEIVED DATA AT A SPECIFIED TIME \(page 5-135\)](#)
- You can print the received Internet fax data when a password has been entered.
 - ▶ [PRINTING A PIN CODE-PROTECTED FAX \(Hold setting for received data print\) \(page 5-134\)](#)
- You can print, forward, or save the received Internet fax data after checking it.
 - ▶ [CHECKING THE IMAGE BEFORE PRINTING \(page 5-136\)](#)
 - ▶ [FORWARDING RECEIVED DATA MANUALLY \(page 5-144\)](#)
 - ▶ [SAVING RECEIVED DATA \(page 5-145\)](#)

1

The machine rings and fax reception begins automatically.

A beep sounds when reception ends.

2

The fax is automatically printed.

RECEIVING INTERNET FAXES MANUALLY

If the interval for checking for received faxes is somewhat long and you wish to check immediately, you can manually initiate reception.



The [Receive] key can be tapped only when POP3 server settings are configured in the Setting mode (administrator).

Tap the [Receive] key to connect to the mail server and retrieve received faxes.

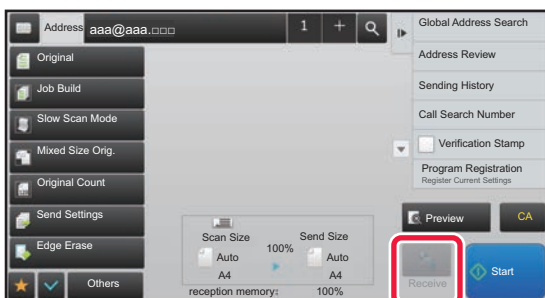



PRINTING RECEIVED DATA

PRINTING A PIN CODE-PROTECTED FAX (Hold setting for received data print)

Enable this setting to have faxes received and stored in memory without being printed. To print the faxes, a PIN Code must be entered.

When this function is used, a PIN Code entry screen appears in the touch panel when a fax is received.



To enable the hold setting for received data print:

In "Settings (administrator)", select [System Settings] → [Image Send Settings] → [Common Settings] → [Condition Settings] → [Hold Setting for Received Data Print].

When the previously programmed 4-digit PIN Code is entered using the numeric keys, printing begins.

When the [Cancel] key is tapped, the PIN Code entry screen closes; however, the data in memory key will blink in the touch panel. The PIN Code entry screen will reappear when you tap the blinking key or change modes.



• **To display the received data list screen after entering the PIN Code:**

In "Settings", select [System Settings] → [Common Settings] → [Operation Settings] → [Condition Settings] → [Preview Setting] → [Received Data Image Check Setting].

• **To transfer received data to another machine:**

In "Settings (administrator)", select [System Settings] → [Image Send Settings] → [Inbound Routing (Forwarding/Storing) Settings].



You can check the received data image on the touch panel before printing.

► [CHECKING THE IMAGE BEFORE PRINTING \(page 5-136\)](#)



• The received faxes will be stored in memory regardless of whether they are received automatically or manually.

• When the received data is transferred to another machine, data stored in memory is also transferred. At that time, the same PIN Code entry screen will appear as for printing. Forwarding will not take place unless the PIN Code is entered.



PRINTING RECEIVED DATA AT A SPECIFIED TIME

Print received data at a specified time.

For stress-free printing, you should avoid printing large numbers of pages at peak times during the day, and when you do not urgently need to print.



- The printed data is automatically deleted from memory.
- If the power is turned off at the specified time, printing will start at the timing when the power is turned on.
- This function can be specified when the Received Data Image Check Setting is enabled.



If Hold Setting for Received Data Print is enabled, this function cannot be used.

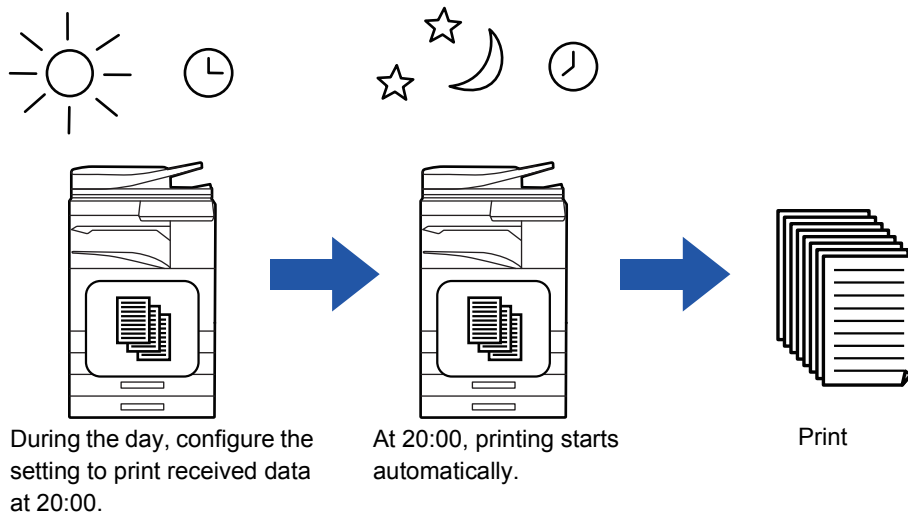

- **To print received data at the specified time:**
In "Settings", select [System Settings] → [Image Send Settings] → [Common Settings] → [Condition Settings] → [Time Specified Output of Received Data].
- **To disable the hold setting for received data print:**
In "Settings (administrator)", disable this function using [System Settings] → [Image Send Settings] → [Common Settings] → [Condition Settings] → [Hold Setting for Received Data Print].



CHECKING THE IMAGE BEFORE PRINTING

Check the image of received data on the touch panel before printing.

This function is available when [System Settings] → [Image Send Settings] → [Common Settings] → [Condition Settings] → [Preview Setting] → [Received Data Image Check Setting] is enabled* in "Settings (administrator)".

* The factory default setting is disabled.



Depending on the size of the received data, part of the check image on the touch panel may not appear.



The received data list can also be shown in the job status screen that appears when you tap the job status display. The received data can be forwarded, deleted, or saved from Received Data List.

► [FORWARDING RECEIVED DATA MANUALLY \(page 5-144\)](#)

► [SAVING RECEIVED DATA \(page 5-145\)](#)

When data is received,  is shown at the top of the screen.

1

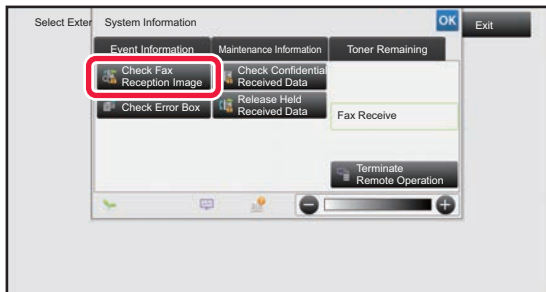

In the System Information, tap the [Event Information] tab and tap the [Check Fax Reception Image] key.

The received data is listed.



You can also display the received data list by tapping the job status display and tapping [Check Received Data] on the action panel of Job Status screen.

2

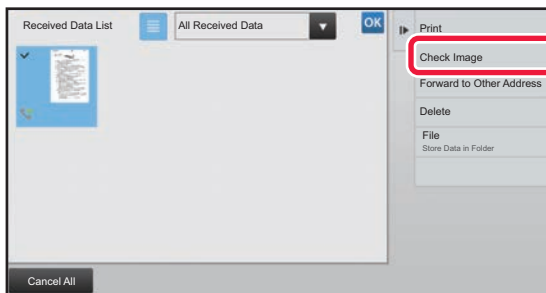

Tap the key of the received data you wish to check, and tap [Check Image] on the action panel.

Displays the received data image.



- Tap  to show thumbnails of received images (Thumbnail screen). The list view or thumbnails view can be changed depending on the setting mode.
- To delete a received image, tap [Delete] on the action panel.
- To transfer the selected received image, tap [Forward to Other Address] on the action panel.
 - [FORWARDING RECEIVED DATA MANUALLY \(page 5-144\)](#)
- To save the selected received image, tap the [File] key.
 - [SAVING RECEIVED DATA \(page 5-145\)](#)



3



Tap the image you wish to print, and tap [Print] on the action panel.

The machine starts printing the image.

- [Select All Page]: Selects all displayed images.
- [Release All Page]: Cancels all images that have been selected by "Select All Page".
- / : Use these keys to enlarge or reduce an image.
- / : Rotates image counterclockwise or clockwise.



- A preview image is an image for the touch panel. It will differ from the actual print result.
- Tap [Erase Specified Range] on the action panel to delete unwanted area of the image. Specify the image area you wish to delete in the Erase Specified Range screen.
- To forward the selected image, tap the [Forward to Other Address] on the action panel.
 - ▶ [FORWARDING RECEIVED DATA MANUALLY \(page 5-144\)](#)
- To save the selected image, tap the [File] key.
 - ▶ [SAVING RECEIVED DATA \(page 5-145\)](#)



FORWARDING RECEIVED DATA

FORWARDING RECEIVED INTERNET FAX DATA (FAX DATA FORWARD)

When the machine cannot print because it is out of paper or out of toner, received Internet faxes are forwarded to another previously registered Internet fax address (including direct SMTP).

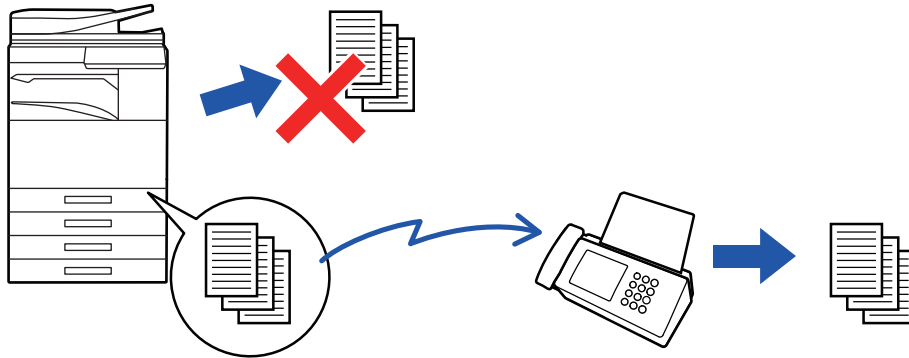

- Forwarding is not possible if no faxes were received or a forwarding fax number is not programmed.
- If some pages of a fax that is being forwarded were successfully printed, only those pages that were not printed will be forwarded.
- If forwarding was not successful because the transmission was cancelled or a communication error occurred, the faxes that were to be forwarded will return to the print queue on the machine.
- If a PIN Code entry screen appears after tapping the [OK] key, "Hold Setting for Received Data Print" has been enabled. Enter the PIN Code using the numeric keys to begin forwarding.
 - ▶ [PRINTING A PIN CODE-PROTECTED FAX \(Hold setting for received data print\) \(page 5-134\)](#)

1

Tap the [Settings] key on the Home screen.

2

Select the [System Settings] key and tap the [Image Send Settings] key.

3

Tap the [Fax Data Receive/Forward (Manual)] key.

4

To start forwarding, tap the [Execute] key of "Forward Received Data" in "I-Fax Settings".



FORWARDING RECEIVED DATA TO PRESET DESTINATIONS (INBOUND ROUTING SETTINGS)

Received Internet faxes are automatically forwarded to a fax destination number, an Internet fax address, an e-mail address, a file server address, a desktop address, or a network folder address.

Received data can be forwarded to the specified destinations without being printed.

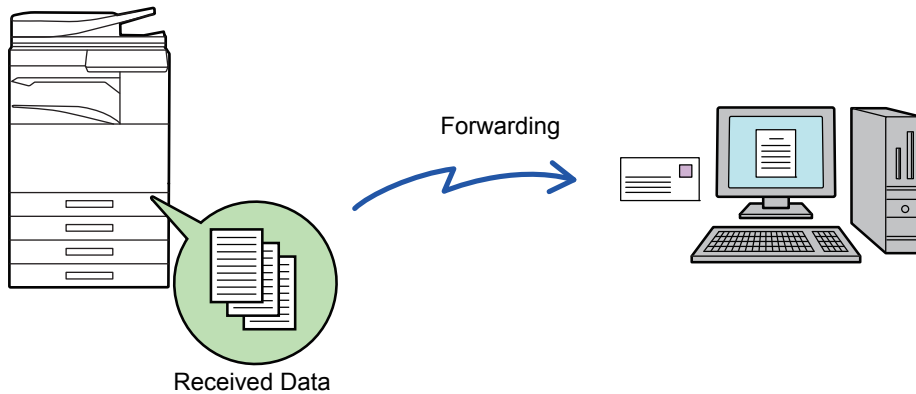

In setting mode (Web version), configure the inbound routing settings. For the procedure for accessing the setting mode (Web version), see Start Guide.

The following explanation assumes that the setting mode (Web version) has been accessed with administrator rights.



Whether or not to forward data for each forwarding table can be quickly set.

In "Settings (administrator)", select [Image Send Settings] → [Inbound Routing (Forwarding/Storing) Settings] → [Administration Settings] → [Inbound Routing], and tap [Enable]/[Disable] on the displayed forwarding table to switch the settings.



- When faxes forwarded using this function are printed at the forwarding destination, the date and time of reception cannot be printed on the faxes. ("Receiving Date & Time Print" is disabled.)
- The received data is not forwarded to a hyperlink destination that is registered in the specified address.
- A direct SMTP address cannot be specified as a forwarding destination.

1

In "Settings (Web version)", click [System Settings] → [Image Send Settings] → [Inbound Routing (Forwarding/Storing) Settings] → [Administration Settings].

2

In "Inbound Routing", select [Enable] and click the [Submit] button.



Users without administrator rights can be prohibited from storing, editing, and deleting forwarding tables in this screen, and from specifying which table is used. To do so, set the checkboxes for the following items to .

- Disable Registration of Forward Table
- Disable Change/Delete of Forward Table
- Disabling of Forward Condition Change

Specify in [Print Style Setting] whether or not to have the machine to print the faxes to forward when inbound routing is enabled. After the settings are completed, be sure to click the [Submit] button.

- [Always Print]: Always prints received data before forwarding the data.
- [Print at Error]: Prints received data only when an error prevents forwarding.
- [Save Only at Error]: Saves received data only when an error prevents forwarding. For the saved data, the error address can be confirmed and the data can be resent.



3

Click **[Sender Address Registration]** in the **[Inbound Routing (Forwarding/Storing) Settings]** menu in the **"Settings (Web version)"**.

4

Enter the sender address or fax number in **"Internet Fax Address"** or **"Fax Number"** as appropriate, and click the **[Add to List]** button.

The sender address or number you entered will be added to the "Address to be Entered" list.

- Enter the address directly (maximum of 1500 characters) or select the address from a global address book by clicking the **[Global Address Search]** button.
- To store multiple sender addresses or fax numbers, repeat these steps.



- If you wish to have only faxes from specified addresses forwarded, store the desired sender addresses. Send addresses stored here can be selected from a list when you store a forwarding table.
- A maximum of 500 sender numbers/addresses can be stored.
- To delete an entered address, select the address in "Address to be Entered" and click the **[Delete]** button.

5

When you have finished adding addresses, click the **[Submit]** button.

6

Click **[Inbound Routing Settings]** in the **"Inbound Routing (Forwarding/Storing) Settings"** menu in the **"Settings (Web version)"** menu and click the **[Add]** button.

7

Enter a **"Table Name"**.



A maximum of 50 forwarding tables can be stored.

8

Select the sender whose faxes will be forwarded.

- To forward all received data, select **[Forward All Received Data]**.
- To forward only data received from specific senders, select **[Forward received data from specified senders only.]**. To forward all data except data from specific senders, select **[Forward all received data except that from specified senders.]**. Select the appropriate senders from the list and click the **[Add]** button.



When selecting senders from the "Sender Number/Address Setting" list, you can use the **[Shift]** key or the **[Ctrl]** key on your keyboard to select multiple senders.



9

Select the forwarding conditions.

- To always forward received data, select [Always Forward].
- To specify a day and time on which received data will be forwarded, select [Forward received data only on specified days.] and select the checkbox () of the desired day of the week. To specify a time, select the [Set Forwarding Time] checkbox () and specify the time.



Up to three forwarding day and time settings can be set for one forwarding table, and a forwarding destination can be set for each set time. To configure these settings, use the [Forward Condition] tabs to access each setting.

10

Select the file format.

The format can be set separately for each forwarding address (for each of forwarding addresses 1, 2, and 3 in the table).



- Images forwarded in TIFF format may not be displayed correctly in some recipient environments. In this event, change the file format to PDF.
- If the Internet fax address is selected as a recipient, data is forwarded in TIFF regardless of the specified format.
- If a fax number is selected as a recipient, the file format is ignored.

11

Select the recipient from the address book.

You can specify multiple registered addresses or telephone numbers from the address book of the machine. Up to 1,000 recipients can be registered for Recipients 1, 2, and 3 in total. When you select the recipients from the address book, up to 400 recipients can be registered for network folder, FTP/Desktop, Internet fax, and fax.



A direct SMTP address cannot be specified as a forwarding destination.

12

Enter a recipient directly and specify the recipient.

- Specify this information if necessary.
- Enter an E-mail address, an Internet fax address, or a fax number directly and tap the [Add to forwarding destinations] key.
- When you specify an E-mail address or a fax number, you can use the global address search.
- When you specify a fax number, also specify the sending line and international correspondence mode.
- When enter the recipients directly, up to 100 recipients can be registered for E-mail address, network folder, FTP/Desktop, Internet fax, and fax.

13

Click [Submit].

14

Click [Inbound Routing Settings] in the "Inbound Routing (Forwarding/Storing) Settings" menu in the "Settings (Web version)" menu.

15

From the forwarding table, select [Forward to All Forward Destinations] or [Forward based on Forward Condition].



16

Select [Always Forward] or [Forward received data only on specified days.] from the forwarding table.

The forwarding permission settings that appear here are linked to the forwarding conditions set in step 9. If you wish to use different forwarding conditions than those set in step 9, set the forwarding permission settings.



- To use the inbound routing function, enable the forwarding tables that you wish to use from among the stored tables.
- To delete a forwarding table, click the checkbox next to the table name so that it is selected () and click [Delete].

17

Click [Submit].

SAVING RECEIVED FAXES TO THE MACHINE'S HARD DISK (INBOUND ROUTING)

Received faxes can be saved to the machine's hard disk. Saved faxes can be viewed on a computer. Set PDF, TIFF (multi) or TIFF (signal) for the saved Internet faxes.

You can also receive notification of the storage result or storage folder by E-mail.

Received faxes are saved in the following directory:

\\MFP\faxreceive

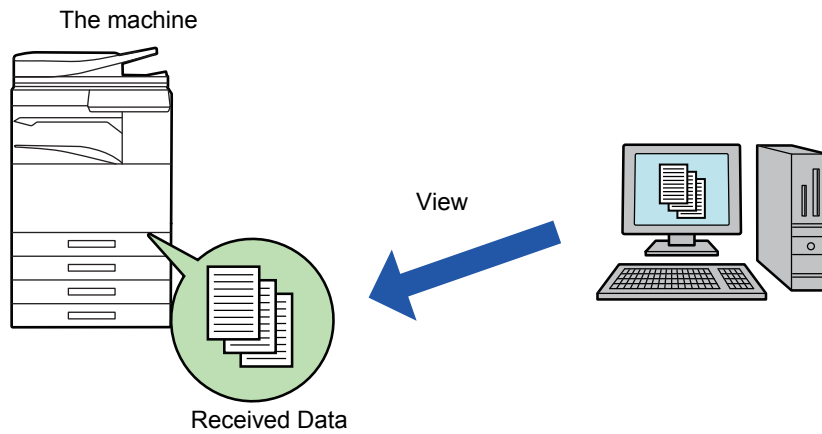

- Up to 500 files can be stored in one folder as received data.
- The "faxreceive" folder contains files of "Settings for HDD Storing of Received Data".
- The folder is automatically created.
- The folder name is automatically assigned based on the setting of "Settings for HDD Storing of Received Data" in the received data save settings.



How to save received faxes to the hard disk

1 In "Settings (administrator)", click [System Settings] → [Network Settings] → [Public Folder / NAS Setting]. (Administrator rights required.)

2 Select [Allowed] in "faxreceive:Use of Storage" and click the [Submit] button.

Settings for saving received faxes to the hard disk

1 In Setting mode (administrator), click [System Settings] → [Image Send Settings] → [Inbound Routing (Forwarding/Storing) Settings] → [Inbound Routing (Storage) Settings] → [Settings for HDD Storing of Received Data]. (Administrator rights required.)



- Data that can be saved are received faxes and received Internet faxes. Confidential reception and polling reception faxes cannot be saved.
 - Depending on the setting, received faxes that cannot be saved because of the file number limit or other reason are either printed or saved in the inbound routing error box.
-



FORWARDING RECEIVED DATA MANUALLY

Received faxes can be forwarded manually after receipt.

This function is available when [System Settings] → [Image Send Settings] → [Common Settings] → [Condition Settings] → [Preview Setting] → [Received Data Image Check Setting] is enabled* in "Settings (administrator)".

* The factory default setting is disabled.

When data is received,  is shown at the top of the screen.

1

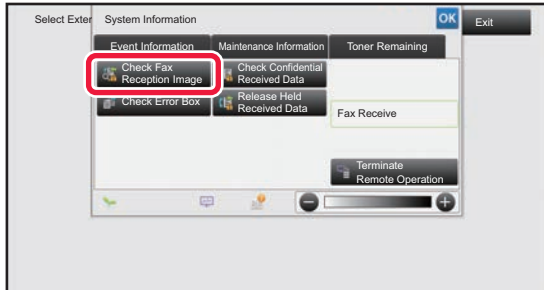

In the System Information, tap the [Event Information] tab and tap the [Check Fax Reception Image] key.

The received data is listed.



You can also display the received data list by tapping the job status display and tapping [Check Received Data] on the action panel of Job Status screen.

2

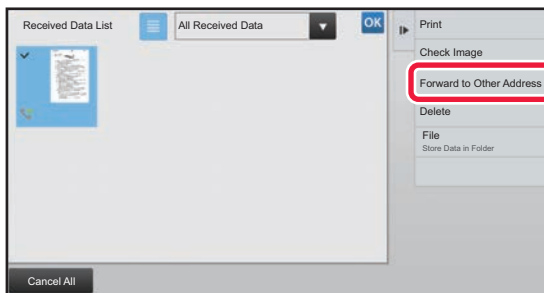

Tap the key of the received data you wish to forward, and tap [Forward to Other Address].

- Tap  to show thumbnails of received images (Thumbnail screen). The list view or thumbnails view can be changed depending on the setting mode.
- Multiple sets of received data can be selected.



When you select a single received data only, you can tap [Check Image] on the action panel and check the image on the preview screen.

3

Select the destination from the Address Book screen, and tap the [Start] key.





SAVING RECEIVED DATA

Save received faxes in the document filing folder.

This function is available when [System Settings] → [Image Send Settings] → [Common Settings] → [Condition Settings] → [Preview Setting] → [Received Data Image Check Setting] is enabled* in "Settings (administrator)".

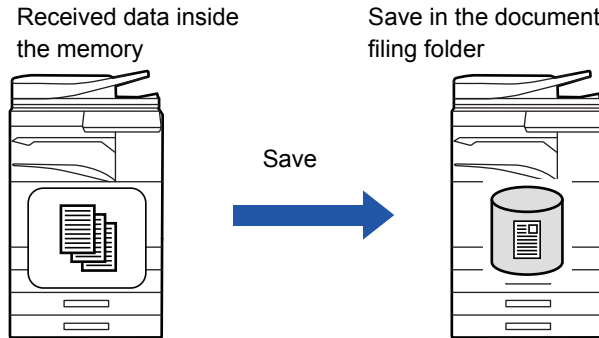
* The factory default setting is disabled.



When data is received,  is shown at the top of the screen.

1

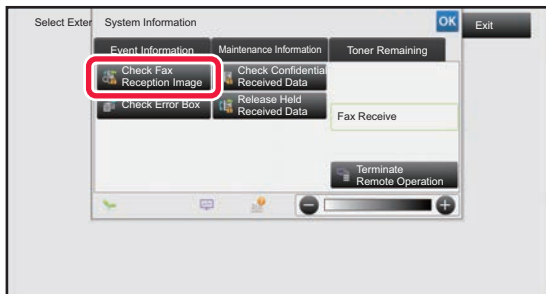

In the System Information, tap the [Event Information] tab and tap the [Check Fax Reception Image] key.

The received data is listed.



You can also display the received data list by tapping the job status display and tapping [Check Received Data] on the action panel of Job Status screen.

2

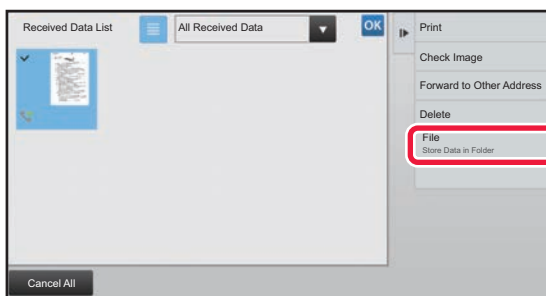

Tap the key of the received data you wish to save, and tap [File] on the action panel.

- Tap  to show thumbnails of received images (Thumbnail screen). The list view or thumbnails view can be changed depending on the setting mode.
- Multiple sets of received data can be selected.



When you select a single received data only, you can tap [Check Image] on the action panel and check the image on the preview screen.

3

Set the file information, and tap the [Save] key.



CHECKING THE STATUS OF TRANSMISSION/RECEPTION JOBS

IMAGE SEND JOBS

When you tap the job status display, jobs are displayed in a list. To check the status of a scanner mode job, select the [Scan] tab. To check the status of an Internet fax job, select the [Internet Fax] tab.

When you wish to stop or delete jobs or to perform priority processing, see the following items:

- ▶ [STOPPING/DELETING A JOB IN PROGRESS OR RESERVED \(page 1-90\)](#)
- ▶ [PRIORITY PROCESSING OF A RESERVED JOB \(page 1-91\)](#)
- ▶ [CHECKING A RESERVED JOB OR THE JOB IN PROGRESS \(page 1-93\)](#)
- ▶ [CHECKING COMPLETED JOBS \(page 1-94\)](#)

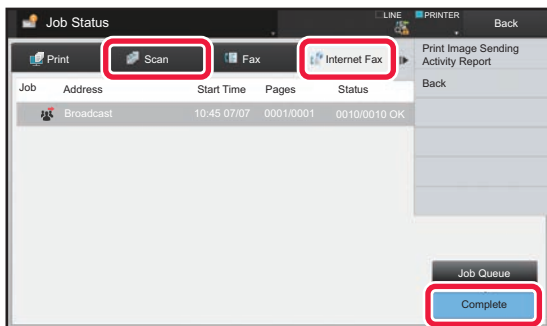

Image send jobs include reception, timer transmission, and data forwarding as well as usual transmission. For the Image Send job operations, see "[COMPLETED TRANSMISSION/RECEPTION JOBS \(page 5-147\)](#)".



COMPLETED TRANSMISSION/RECEPTION JOBS

A usual transmission job moves to the job list when transmission is completed. Then the status field displays "Send OK". However, Internet Fax jobs such as reception, timer transmission, retries, and forwarding are displayed in the job status screen as follows:

Reception job

During Internet Fax receiving, the status field displays "Receiving" in the job queue list. When reception is completed, the job moves to the completed job list and the status field displays "In Memory". After Internet Fax printing is completed, the status changes to "Received".

Timer transmission jobs

A timer transmission job appears at the end of the job queue list until the specified time is reached. Transmission begins at the specified time. When transmission is completed, the job moves to the completed job list and the status field displays "Send OK".

Internet Fax transmission job with reception report request specified

An Internet Fax transmission job with a reception report request specified, excluding a direct SMTP transmission job, is placed into the standby state at the bottom of the Job Queue screen after a transmission has been completed. "Report Wait" appears in the status field.

The screen changes to the completion screen when a reception report e-mail has been received from the destination.

Reception jobs when the inbound routing settings are enabled

When the inbound routing settings are enabled, reception jobs are handled as follows depending on the print setting.

► [FORWARDING RECEIVED DATA TO PRESET DESTINATIONS \(INBOUND ROUTING SETTINGS\) \(page 5-139\)](#)

Received data is not printed

When a data is being received, "Receiving" appears in the job queue list. When the reception is completed, the status changes to "Waiting".

Received Internet fax is printed

When reception is completed, the status field displays "In Memory" in the completed job list. After the fax is printed, the status changes to "Received". Then a job is added for which the status field displays "Waiting" in the job queue list.

When forwarding the received fax is completed, the field changes to "Forward OK".



SCANNING FROM A COMPUTER (PC Scan Mode)

BASIC SCANNING PROCEDURE

You can install the scanner driver on your computer and use a TWAIN* compliant application to scan an image using your computer.

Scanning from your computer is most useful for scanning a single original such as a photo, particularly when you want to adjust scan settings as you scan. By contrast, scanning at the machine is most useful for continuous scanning of multiple originals.

* An interface standard used for scanners and other image input devices. When the scanner driver is installed on your computer, you can use any TWAIN-compliant application to scan an image.



- For the procedures for installing the scanner driver and configuring settings, see the Software Setup Guide.
- This function cannot be used when it has been disabled using "Disable Scan Function" in the system settings (administrator).
- The procedures for selecting the scanner driver and starting scanning vary depending on the TWAIN-compliant application. For more information, see the manual for the application or Help.
- When a large image is scanned at high resolution, the amount of data will be very large and scanning will take a long time. Be sure to select appropriate scan settings for the original (text, photo, etc.).
- A print job cannot be printed while remote PC scan is in progress. The print job will print when remote PC scan ends.
- Remote PC scan cannot be performed while a print job is in progress.

As an example, the procedure for scanning from the "Sharpdesk" application is explained below.

[At the machine]

1

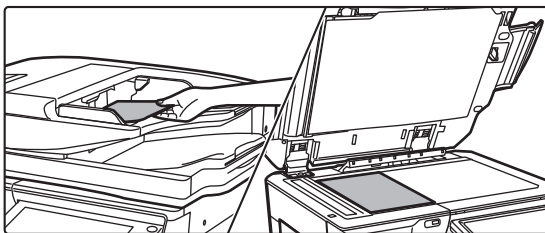

Place the original.

Place the original face up in the document feeder tray, or face down on the document glass.



2

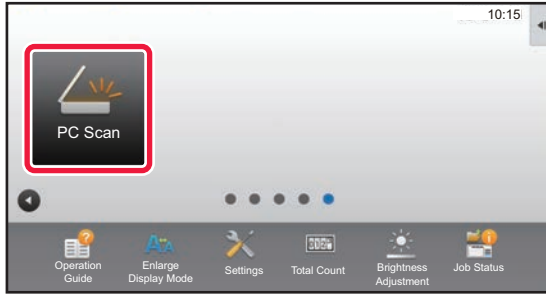

Tap the [PC Scan] mode icon to switch to PC Scan mode.

If the [PC Scan] mode icon does not appear, tap  to move the screen.



When PC scan mode is selected, only the [Exit] key displayed in the touch panel can be used on the machine; no other keys can be used.

[At your computer]

3

Start the TWAIN-compliant application on your computer and select [Select Scanner] from the [File] menu.

4

Select the scanner driver of the machine.

- (1) Select [SHARP MFP TWAIN K].
- (2) Click the [Select] button.

5

Select [Acquire Image] from the [File] menu.

The scanner driver opens.



6

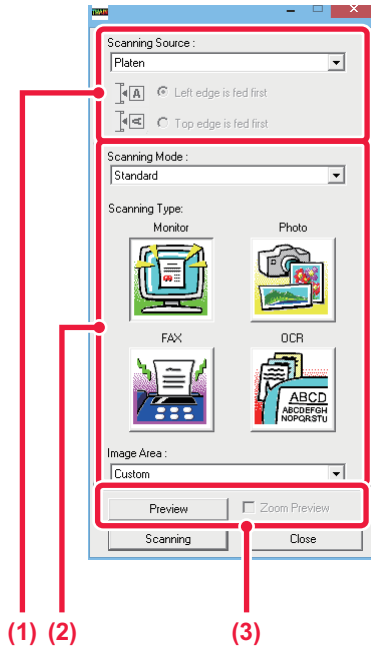

Preview the image.

(1) Select the location where the original is placed.

"Scanning Source" menu:

- If the original is a one-sided original and is placed in the document feeder tray, select [SPF(Simplex)].
- If the original is a 2-sided original and is placed in the document feeder tray, select [SPF(Duplex - Book)] or [SPF(Duplex - Tablet)] depending on whether the original is a book-style or tablet-style original. In addition, select [Left edge is fed first] or [Top edge is fed first] depending on the orientation of the original.

(2) Select scan settings.

"Scanning Mode" menu:

Switch between the "Standard" screen and the "Professional" screen. In the "Standard" screen, select "Monitor", "Photo", "FAX" or "OCR" depending on the original type and your scanning purpose.

If you wish to change the initial settings of any of the four buttons or select the resolution or other advanced settings, change to the "Professional" screen.

"Image Area" menu:

Select the scan area. If "Auto" is selected, the original size detected by the machine will be scanned. You can also set the scanning area in the preview window with your mouse.

(3) Click the [Preview] button.

The preview image will appear in the scanner driver. If you are not satisfied with the preview image, repeat (2) and (3).

If the [Zoom Preview] checkbox is selected before the [Preview] button is clicked, the selected area will be enlarged in the preview window. If the checkmark is removed, the preview image will return to normal. Note that if SPF is selected in the "Scanning Source" menu, the [Zoom Preview] function cannot be used.



- For further information on the scan settings, click the button in the preview image screen of step 7 to open scanner driver Help.
- If the [Preview] button is clicked when scanning from the document feeder tray, only one original page will be scanned for the preview image. If you wish to include that original in the scan, return it to the document feeder tray.



7

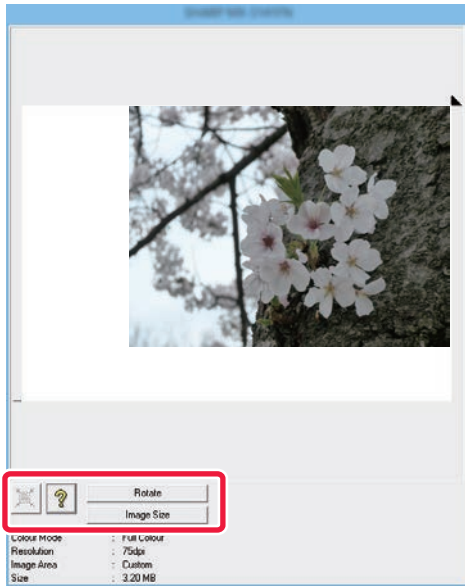

Select scanning settings while viewing the image.

[Rotate] button:

Each time this button is clicked, the preview image rotates 90 degrees. This lets you change the orientation of the image without picking up and placing the original again. The image file will be created using the orientation that appears in the preview window.

[Image Size] button:

Click this button to specify the scan area by entering numerical values. Pixels, mm, or inches can be selected for the units of the numerical values. If a scanning area has already been specified, the entered numbers will change the area relative to the top left corner of the specified area.

[? button:

When a preview image is displayed and a scanning area is not specified, you can click the button to automatically set the scanning area to the entire preview image.



- For further information on the scan settings, click button to open scanner driver Help.
- If the originals are placed in the document feeder tray, only the top page will be previewed. The top page will be delivered to the original exit tray. Be sure to return the previewed page to the document feeder tray before previewing again or scanning.

8

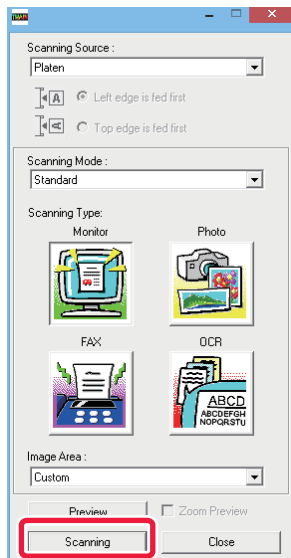

Click the [Scanning] button.

Scanning begins. The image appears in your application. Assign a file name to the scanned image and save it as appropriate in the software application you are using.



[At the machine]

9

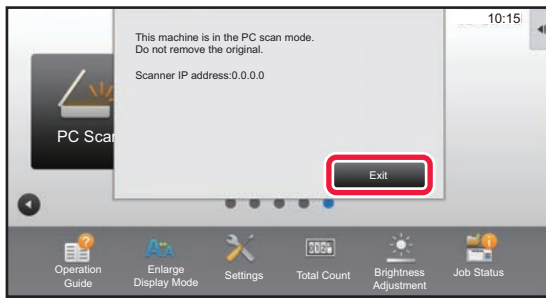

Tap the [Exit] key.

10

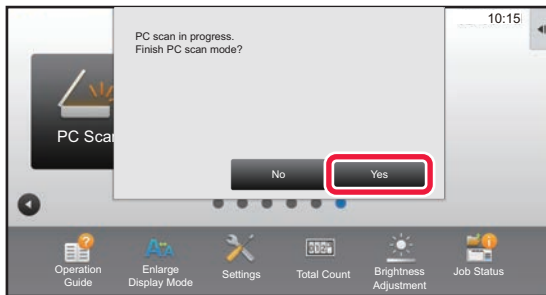

Tap the [Yes] key.



METADATA DELIVERY

PREPARATIONS FOR METADATA DELIVERY

METADATA DELIVERY (DATA ENTRY)

When the application integration module kit is installed, metadata (data indicating the attributes of the image file and how it is to be processed) is generated based on pre-stored information and transmitted separately from an image file that is generated for sending a scanned image. The metadata file is created in XML format. By linking the metadata with applications such as document management software, a workflow application, or an encryption server, a sophisticated document solution environment can be built. Using the application integration module kit, information on a generated image file can be entered at the touch panel and transmitted along with the image as an XML file.

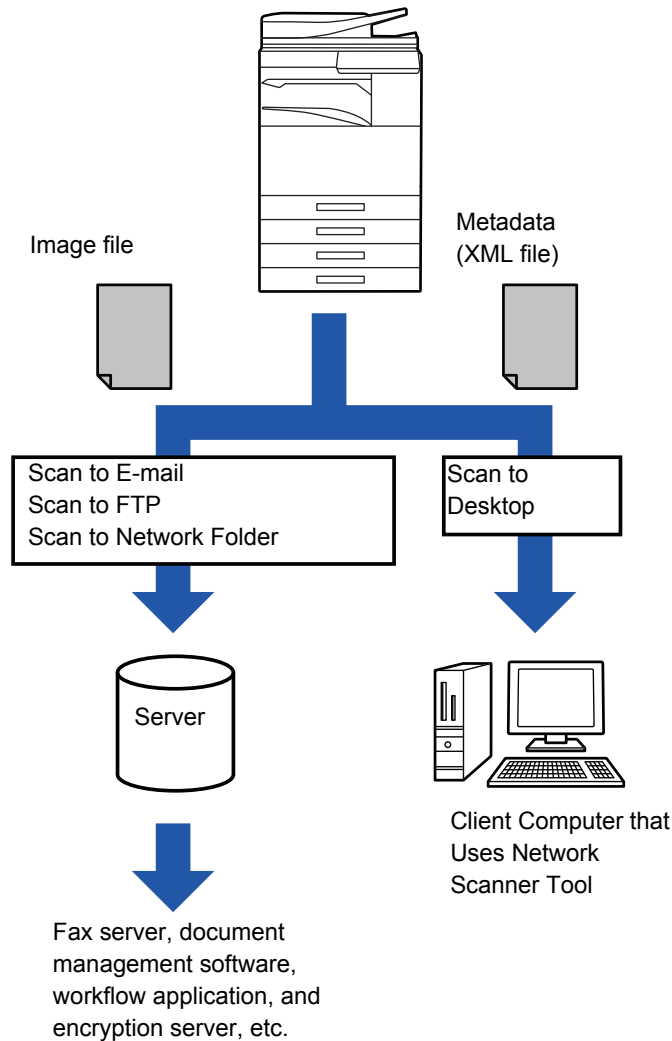



SETTINGS REQUIRED IN THE SETTING MODE (WEB VERSION)

To configure the settings related to metadata, select [System Settings] → [Image Send Settings] → [Metadata Settings] → [Metadata Entry] in "Settings (administrator)". (Administrator rights are required.)
Enable metadata delivery.

Storing Metadata Sets

Store the items (the metadata set) to write to the XML file that will be generated during scanning. Up to 10 metadata items can be configured in a metadata set. A stored metadata set can be selected at the time of transmission.

Addresses specified in "Address Type Allowing Metadata Entry" when a metadata set is stored can be selected as transmission destinations at the time of transmission using one-touch keys, manual entry, or a global address book search. (Addresses for which metadata entry is not allowed cannot be specified as transmission destinations.)

METADATA DELIVERY USING SCAN TO DESKTOP

When Network Scanner Tool is used in its factory default configuration, a file will be generated with a new file name on the PC.

When Network Scanner Tool is used as a means of sending a metadata file to a third party application, this setting must be disabled to allow cross referencing between the image file and XML file by means of the file name generated by the computer. (When setting the file name in [Options ▼], to ensure that an existing file on the PC is not overwritten by a transmitted file of the same name, be sure to configure the file name so that name duplication will not occur; for example, by including a unique extension (the date, etc.) in the generated file name. If the file name setting is left blank, the machine will automatically generate a unique file name.)



It is recommended that you use Network Scanner Tool to receive metadata.

For information on the license agreement and how to use the CD-ROM that accompanies the application integration module, see the separate "Sharpdesk license kit" manual.

Using third party applications

Various types of third party applications exist. Some applications can start automatically from Network Scanner Tool and some cannot.

When the auto-run function of an application is enabled, Network Scanner Tool will start the application with the ".exe" command using the image file name as a parameter. For example, when Network Scanner Tool is set to start application "APP.EXE", the "APP.EXE IMG.TIF" command is applied. If a file was specified to receive metadata, the metadata file name cannot be specified at the same time using the command to start the application directly. (However, the metadata file is stored in the same folder as IMG.TIF in the computer.)



TRANSMITTING METADATA

TRANSMITTING METADATA

Select a metadata set, enter each item, and perform metadata delivery.



Metadata delivery is performed using the document filing function. The [Data Entry] tab appears in the transmission settings screen of document filing mode to allow metadata delivery.

In addition, perform metadata delivery using document filing in [Metadata Entry] in "Settings (Web version)."



- **In data entry mode, configure metadata settings to perform metadata delivery.**

To perform transmission without sending metadata, switch the screen from data entry mode to a different mode and then perform transmission.

• When metadata settings have been configured or an address is specified in data entry mode, it will not be possible to switch to another mode.

• Before configuring metadata settings, specify addresses in all available modes. After metadata settings have been configured, specify only addresses in modes that are allowed in the selected metadata.

1

Tap the [Data Entry] icon on the [Home Screen], and tap [Metadata Set].



If a specific metadata set has been specified as the default set, go to step 3.



If no metadata sets have been stored, Metadata Entry is unavailable. Store metadata set in the setting mode (Web version) before performing transmission.

2

Tap the key for the desired metadata set.

3

The keys of the items stored in the metadata set will appear. Tap the key of the item that you wish to enter.

4

Tap the key of the value that you wish to enter, and tap the [OK] key.

To directly enter the metadata value, tap the [Direct Entry] key. On the soft keyboard screen that appears, tap the [OK] key. You will return to the screen shown in step 3.

After the settings are completed, tap **OK**.



To cancel the selection of the metadata value: Tap the [Clear] key.

5

Configure image or other settings, and perform the scan send procedure.

- Configure job detail settings and then start transmission using the same operations as in other modes.

- When directly entering an address, tap [Touch to input Address] to display the screen for selecting an address type. If the address type such as E-mail, Internet Fax, Fax, Network Folder, or Direct SMTP is selected, the address type entry screen appears.



METADATA FIELDS

The following three types of metadata are included in the XML file that is transmitted.

- Data automatically generated by the machine

These data are always included in the XML file and are automatically stored on your PC.

- Previously defined fields

These fields are automatically recognized by the machine and assigned to appropriate XML tags. These fields can be selected, and can only be included in the XML file if they are enabled in the setting mode (Web version).

- User defined fields

Custom fields are added to the XML file. These fields can be selected and are defined in the setting mode (Web version).

If a defined metadata field is one of the following fields, a message will appear informing you that the field cannot be filled in. Enter appropriate information in the related items of the send settings.

Name entered in metadata fields	Description	Where entered
formName	Name of the user who sent the job. If the name is not entered as metadata, the sender name determined by the usual rules for determining the sender name will be applied as metadata.	[Reply-To] (sender name of selected sender)
replyTo	E-mail address to which the transmission result will be sent.	[Reply-To] (E-mail address of selected sender)
documentSubject	Job name appearing in the E-mail "Subject" line, or job name on the fax cover sheet. When the user enters a [Subject] in the send settings screen in the touch panel, the entered value is applied as metadata.	[Subject] (Blank until a value is set in the send settings screen.)
fileName	Enter the file name of the image to be sent.	[File Name] (Only when the [Allow Custom Filenames] checkbox is selected in the metadata entry screen in the setting mode (Web version)) (Blank until a value is set in the send settings screen.)



DOCUMENT FILING

Icons



Functions that you can use with Easy Scan

DOCUMENT FILING

DOCUMENT FILING	6-2
• TYPES OF DOCUMENT FILING	6-3
• BEFORE USING SCAN TO HDD IN DOCUMENT FILING	6-3
• IMPORTANT POINTS WHEN USING DOCUMENT FILING	6-6
• USING DOCUMENT FILING IN EACH MODE ...	6-7
BASE SCREEN OF DOCUMENT FILING MODE ...	6-8

SAVING FILES WITH DOCUMENT FILING

FILING WHILE USING ANOTHER MODE	6-9
• QUICK FILE	6-9
• FILE	6-10



SAVING DOCUMENT DATA ONLY (SCAN TO HDD)	6-14
• SAVE ON HDD	6-14
• SAVE IN EXTERNAL MEMORY DEVICE	6-16

USING STORED FILES

SEQUENCE FOR USING A STORED FILE	6-20
FILE SELECTION SCREEN	6-21
SELECTING A FILE TO RETRIEVE	6-22
FILE PRINTING	6-22
MULTI-FILE PRINTING	6-24
• MULTI-FILE PRINTING	6-24
• BATCH PRINTING	6-25
FILE TRANSMISSION	6-26
FILE MOVING	6-27
DELETE FILE	6-28
FILE IMAGE CHECKING	6-30
FILE MERGING	6-31
RETRIEVING AND USING A FILE FROM THE JOB STATUS SCREEN	6-32
FILE SEARCH AND RETRIEVAL	6-33
PRINTING AN EXTERNAL FILE	6-35



DOCUMENT FILING

DOCUMENT FILING

This function saves the original scanned on the machine, transmitted fax image, or print data from a computer on the hard drive of the machine or an external memory device as data.

The stored files can be printed or transmitted as required. Editing of the stored files, for example combining, is also possible.



A PDF file created for PC browsing can be displayed or printed on a computer.

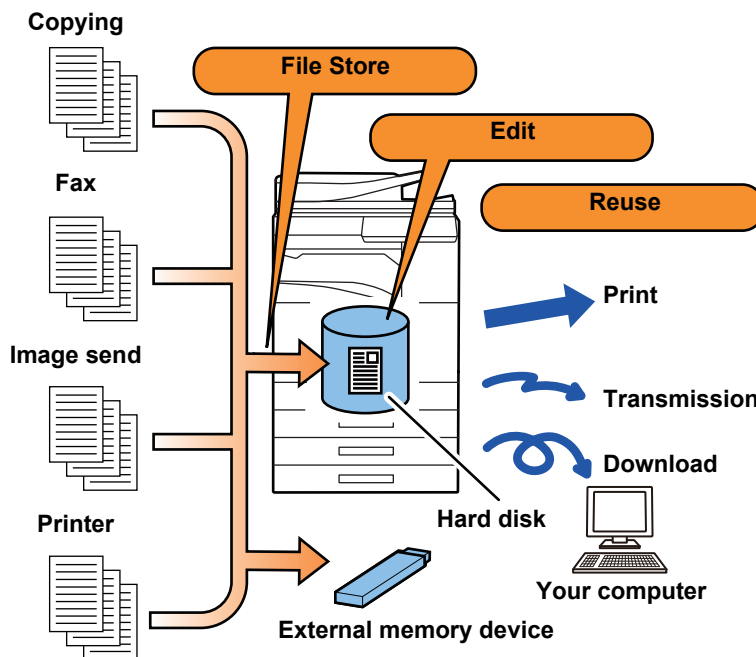

Uses of document filing

Using the document filing function allows you to additionally print out conference material with the same settings, or print out ledger sheets used for routine tasks as required.

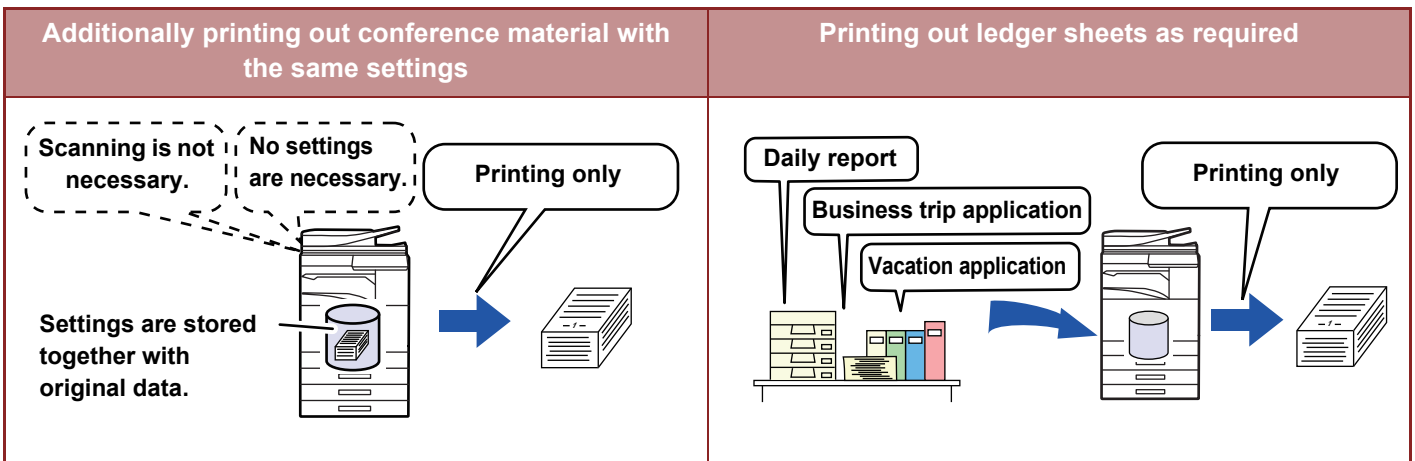



TYPES OF DOCUMENT FILING

There are the following ways to save a file using document filing: [Quick File] and [File] in copy mode or image send mode, and [Scan to HDD] and [Scan to External Memory Device] in document filing mode.

Quick File	As a copy, image send, or other job is performed, this function saves the document data to the hard drive. Use this function when you want to quickly and easily store document data without specifying a file name or other information. The stored file can also be used by other people. Do not use this method to save files that you do not want others to use.
File	As a copy, image send, or other job is performed, this function saves the document data to the hard drive. Unlike Quick File, various types of information can be appended to the file when the file is saved to enable efficient file management. A password can also be established.
Scan to HDD	This function scans an original and stores it to the hard drive. Like File, various types of information can be appended.
Scan to External Memory Device	This function scans an original and stores it in an external memory device such as a USB memory device. Like File, various types of information can be appended.

BEFORE USING SCAN TO HDD IN DOCUMENT FILING

Folder types

Three types of folders are used to store files on the hard drive using the document filing function.

Folders on the hard drive

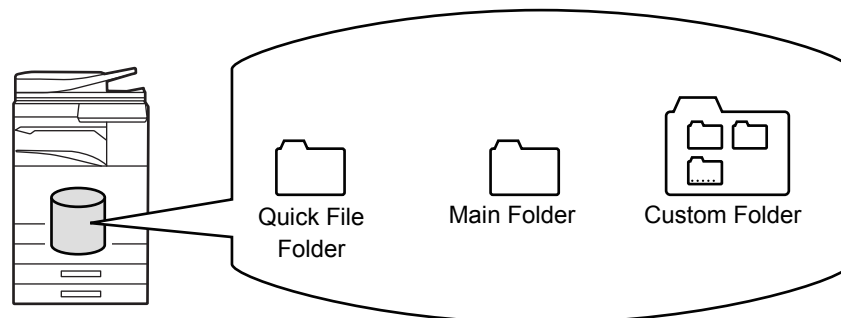

Quick File Folder

Documents scanned using [Quick File] on the action panel are stored in this folder. A user name and file name are automatically assigned to each job.

Main Folder

Scanned documents are stored in this folder.

When you store a job in the Main folder, you can specify a previously stored user name and assign a file name. A password (5 to 32 characters) can also be set when storing a file ("Confidential" save) as required.

Custom Folder

Folders with custom names are stored inside this folder.

Scanned documents are stored in the stored folder.

Like the Main folder, a custom folder allows you to specify a previously stored user name and assign a file name when storing a job.

Passwords (PIN code: 5 to 8 digit number) can be established for custom folders and for files saved in custom folders.



A maximum of 1000 custom folders can be created on the hard drive.



Convenient items to store

When storing a job using [File] in copy mode or image send mode, or [Scan to HDD] in document filing mode, it is convenient to store the items below. These settings are not required when storing a job using [Quick File].

User Name	This is necessary if you will be assigning a user name to stored files. A user name is also used as a search condition when searching for a file.
Custom Folder	The Main folder is initially available as a location for storing files by [File] and [File Store]. Store a custom folder and specify it as a location for storing files. Specify a password for the user folder as required. Enter the PIN Code to use the folder.
My Folder	A previously created custom folder can be selected as "My Folder", or a new folder created as "My Folder". When "My Folder" has been configured and user authentication is used, "My Folder" will always be selected as the destination of [File] and [File Store].



- **To store a custom folder for document filing:**

On the Web page, select "Settings (administrator)" → [Document Operations] → [Document Filing] → [Custom Folder].

On the machine, select "Settings (administrator)" → [System Settings] → [Document Filing Settings] → [Document Filing Control] → [Custom Folder].



- **To store a user name and specify a folder as "My Folder":**

In "Settings (administrator)", select [User Control] → [User List].





Approximate number of pages and files that can be stored

Combined total number of pages and total number of files that can be stored in custom folders and in the Main folder

Examples of original types	Number of pages*	Number of files
<p>Full colour original (Text and photo example)</p>  <p>Size: A4</p>	Max. 5700	Max. 3000
<p>Black & white original (Text)</p>  <p>Size: A4</p>	Max. 13000	

Number of pages and number of files that can be stored in the Quick File folder

Examples of original types	Number of pages*	Number of files
<p>Full colour original (Text and photo example)</p>  <p>Size: A4</p>	Max. 700	Max. 1000
<p>Black & white original (Text)</p>  <p>Size: A4</p>	Max. 2000	

* The indicated numbers are guidelines for the number of pages that can be stored when all pages are full colour, and when all pages are black & white.

Copying in sort mode uses the same memory area as the main folder and custom folder. For this reason, when too much data has been stored in the main folder and custom folder, it may not be possible to perform a large copy job using sort mode. Delete unnecessary files from the main folder and custom folder.

The original types above are examples to make the explanation easier to understand. The actual number of pages and number of files that can be stored will vary depending on the contents of the original images and the settings when the files are stored.



Information added to files

When saving a file using "File", add the following information to distinguish it from other files.

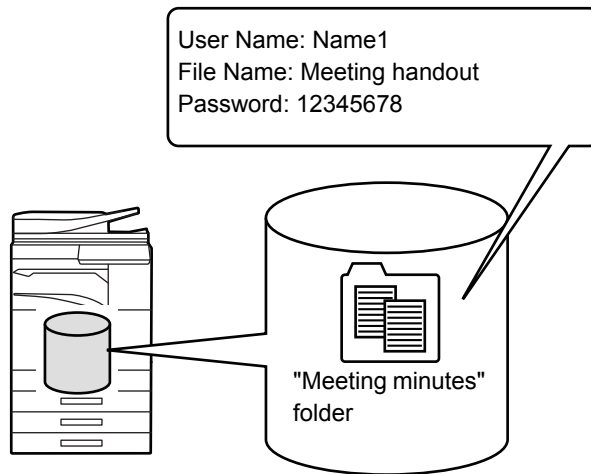

User Name	The user name is required to enter a file ownership and other information. The user name must be registered in advance.	
File Name	Names a file.	
Stored to	Specifies a folder to store files.	
Property	Sharing	Any user can display and operate files having the "Sharing" property.
	Protect	Once "Protect" is set, its file cannot be edited, moved, and deleted. No password setting is required.
	Confidential	You can set a password (5 to 32 characters) for file protection.



- The above information cannot be specified when a file is saved with Quick File.
- When you select [Create Downloadable File] in Scan to HDD and save as a confidential file, the properties cannot be changed.



To store a user name:

In "Settings (administrator)", select [User Control] → [User List].

IMPORTANT POINTS WHEN USING DOCUMENT FILING

- Files stored using [Quick File] are provided with the "Sharing" property that can be accessed by any person for output and sending. Therefore, do not store sensitive documents or documents that you do not want to be used by others using the [Quick File] function.
- When saving a file with [File], you can save it with the "Confidential" property. Set a password for a "Confidential" file to prevent the file from being used by other people. Exercise care to prevent other people from obtaining the password.
- The property of a stored "Confidential" file can be changed to "Sharing" by "Property Change" as required. Do not store sensitive documents or documents that you do not want to be used by others.
- Except in cases provided for by law, SHARP Corporation bears no responsibility for any damages that result from the disclosure of sensitive information due to manipulation by a third party of any data saved using the Quick File function or File function, or incorrect operation of the Quick File function or File function by the operator who saves the data.



USING DOCUMENT FILING IN EACH MODE

To use Document Filing, select the action panel for each mode.

To save data simultaneously with a copy or fax, tap [File] or [Quick File] on the action panel in each mode.

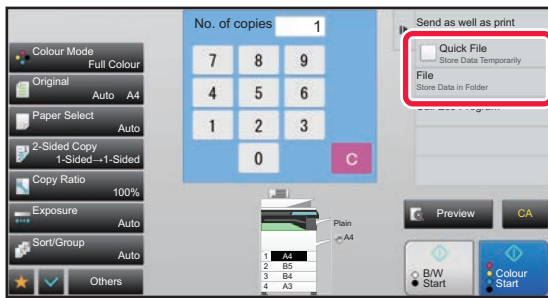

To use Document Filing from the beginning, select the action panel in the Document Filing mode. Tap any one of the keys to scan and save the original.

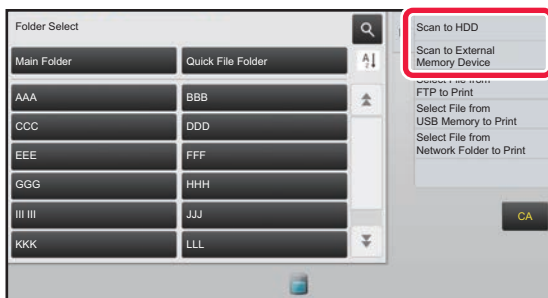

• **[File] and [Quick File]**

These keys may not appear on the action panel depending on the mode or settings. In this case, tap [Others] on the base screen in each mode, and then tap [Quick File] or [File].

• **Using document filing in print mode**

To use document filing in print mode, select document filing in the printer driver. For details on document filing, see "[SAVING AND USING PRINT FILES \(DOCUMENT FILING\) \(page 3-76\)](#)" in "PRINTER".

• **Using document filing in PC-Fax/PC-I-Fax mode**

To use document filing in PC-Fax or PC-I-Fax mode, select document filing settings in the PC-Fax driver. For more information, see Help in the PC-Fax driver.



BASE SCREEN OF DOCUMENT FILING MODE

The screenshot shows the 'Folder Select' screen in Document Filing Mode. It features a grid of folders, a search function, and a list of actions. Red lines connect text annotations to specific UI elements.

- Use to save originals to be shared among users.** Points to the 'Main Folder' button.
- Use to save a file temporarily.** Points to the 'My Folder' button.
- Use to search for a file in a folder.** Points to the search icon (magnifying glass).
- Displays the functions available in document filing mode.** Points to the list of actions on the right, including 'Scan to HDD', 'Scan to External Memory Device', and 'Select File from FTP to Print'.
- Switch the custom folder order between ascending and descending.** Points to the 'A ↓' sort icon.
- Resets all settings.** Points to the 'CA' button.
- The folder for the registered user.** Points to the grid of folders (AAA, BBB, CCC, DDD, etc.).
- Displayed during user authentication. Tap this key to open the logged-in user's personal screen.** Points to the 'CA' button.
- Displays the usage status of the machine's built-in hard disk drive. Tap the key to display details.** Points to the hard disk icon at the bottom center.



SAVING FILES WITH DOCUMENT FILING

FILING WHILE USING ANOTHER MODE

QUICK FILE

This function allows you to store an original in copy mode or image send mode as an image file in the Quick File folder of the machine.

The image file stored in quick file mode can be retrieved at a later time, allowing you to copy the document or transmit it in image send mode without having to locate the original.

As an example, the procedure for using "Quick File" in copy mode is explained below.



- Quick File can be used in normal mode.
- When a file is stored using Quick File, the following user name and file name are automatically assigned to the file.
User Name: User Unknown
File Name: Mode_Month-Day-Year_Hour-Minute-Second
(Example: Copy_04042015_112030AM)
Save location: Quick File Folder
When user authentication is used, the user name that was used for login is automatically selected.
Only the file name and location of a file stored in the Quick File folder can be changed.



To delete all files in the Quick File folder with the exception of protected files:

In "Settings (administrator)", select [System Settings] → [Document Filing Settings] → [Condition Settings] → [Delete All Quick Files]. Configure settings to have all files deleted when the power is turned on as required.

1

Place the original.

Place the original in the document feeder tray of the automatic document feeder, or on the document glass.

- [SELECTING A PROCEDURE FOR PLACING THE ORIGINAL DEPENDING ON THE TYPE AND STATUS OF THE ORIGINAL \(page 1-83\)](#)

2

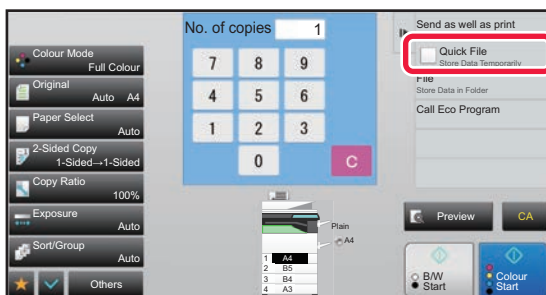

Change to normal mode and tap [Quick File] on the action panel so that it is selected .



When a message relating to saving confidential information appears, tap the [OK] key.



3

Start a copy or image sending.

When the function is executed, the image data of the original is stored in the Quick File folder.



To prevent accidental saving of the file, the message "The scanned data is stored in the quick file folder." appears for 6 seconds (default setting) after the [Start] key ([Colour Start] key or [B/W Start] key in copy mode) is tapped.

To change the message display time, in "Settings (administrator)" → [System Settings] → [Common Settings] → [Operation Settings] → [Condition Settings] → [Message Time Setting].



To cancel Quick File:

Tap [Quick File] to enable .

FILE

Tapping the [File] key of the document filing function when printing or transmitting an original in each mode allows you to store the original in the Main folder or stored Custom folder as a file simultaneously with printing or transmission. The stored file can be retrieved at a later time, allowing you to recopy or resend the original without having to locate it. As an example, the procedure for using "File" in copy mode is explained below.



- File can be used in normal mode.
- When a file is stored using File without appending file information, the following user name and file name are automatically assigned to the file.

User Name: User Unknown

File Name: Mode_Month-Day-Year_Hour-Minute-Second

(Example: Copy_04042015_112030)

Save location: Main Folder

1

Place the original.

Place the original in the document feeder tray of the automatic document feeder, or on the document glass.

- [SELECTING A PROCEDURE FOR PLACING THE ORIGINAL DEPENDING ON THE TYPE AND STATUS OF THE ORIGINAL \(page 1-83\)](#)



There are also cases where settings are required to be made before a preview is carried out.



2

Change to normal mode and tap [File] on the action panel to specify the file information.

To select the user name, file name, folder, and property setting, see "[File Information \(page 6-12\)](#)".

To save on the HDD:

- ▶ [Changing the property \(page 6-12\)](#)
- ▶ [Specifying a user name \(page 6-13\)](#)
- ▶ [Assigning a file name \(page 6-13\)](#)
- ▶ [Specifying the folder \(page 6-13\)](#)
- ▶ [Creating PDF for PC browsing \(page 6-13\)](#)

To save in an external memory device:

- ▶ [Assigning a file name \(page 6-13\)](#)
- ▶ [Specifying the folder \(page 6-13\)](#)
- ▶ [Creating PDF for PC browsing \(page 6-13\)](#)

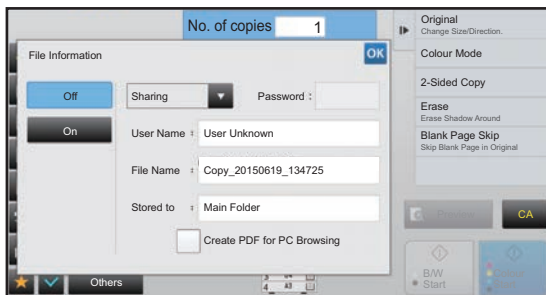

After configuring the above settings, you will return to this screen. Go to the next step.

If you do not wish to assign a user name or other information to the file, go to the next step.

3

Tap **OK**.

You will return to the base screen of copy mode.

4

Select copy settings and then tap the [Colour Start] key or the [B/W Start] key.

- Simultaneously with starting copy, the original is stored as a file. The selected copy settings are also saved.
- For the procedure for placing the original, see "[SELECTING A PROCEDURE FOR PLACING THE ORIGINAL DEPENDING ON THE TYPE AND STATUS OF THE ORIGINAL \(page 1-83\)](#)".



File Information

The procedure for detail settings is described below.

Specifying a property, user name, file name, and folder makes it easier to manage and search for a file. In addition, when [Confidential] is selected for Property and a password is established, other people will not be able to view the file without permission.

Changing the property

A protect setting can be selected for files saved with the document filing function. This prevents a file from being moved, or automatically or manually deleted.

Three properties are available for saved files: "Sharing", "Protect", and "Confidential". When saved with the "Sharing" property, a file is not protected. When saved with the "Protect" or "Confidential" property, a file is protected.

Files saved to the Quick File folder are all saved as "Sharing" files. When a file is saved to the Main folder or a custom folder, "Sharing", "Protect" or "Confidential" can be selected.

Sharing	A "Sharing" file can be changed to "Protect" or "Confidential" using "Property Change" in the Job Settings.
Protect	"Protect" does not require setting of a password, but prevents a file from being moved, deleted or edited. A password cannot be established.
Confidential	To protect a "Confidential" file, a password is set. (The password must be entered to retrieve the file.) When a file is saved in encrypted PDF format, the file property is automatically set to "Confidential".



Restrictions on changing the property

- A file that is set to "Sharing" can be changed to "Protect" or "Confidential" as required. However, a "Sharing" file that is saved in the Quick File folder can only be changed to "Protect".
- A file that is set to "Protect" can be changed to "Sharing" or "Confidential" as required. However, a "Protect" file that is saved in the Quick File folder can only be changed to "Sharing".
- A file that is saved in the Quick File folder cannot be changed to "Confidential". If the file is moved to the Main folder or a custom folder, the property can be changed to "Confidential".
- Two properties cannot be selected for a single file.

1

Select [Property] in the File Information screen.

2

When you have selected [Confidential], enter a password (5 to 32 characters).

Every time you enter one digit, "*" is displayed.



Specifying a user name

1 Tap the [User Name] text box.

When user authentication is used, the user name that was used for login is automatically selected. In this case, this step is not necessary.



The user name must first be stored by selecting [User Control] in "Settings (administrator)" → [User List].

2 Tap the key of the user name.

Alternatively, you can select a user name by tapping the [Call with Registration Number] key and entering the user number. The user number must be first set by selecting [User Control] in "Settings (administrator)" → [User List].

3 Tap .

The system goes back to the screen of step 1 to display the selected user name.

Assigning a file name

A file name can be assigned to the file.

1 Tap the [File Name] text box and enter the file name.

Enter a file name using up to 30 characters.



File Name

- If a file name that already exists is specified, a tilde and a serial number are added after the file name and this file is saved as a different file. The file name is not case-sensitive.
For example, if the "test.txt" file already exists and you specify the "TEST.TXT" file, the file will be saved as "TEST.TXT~1" file.
- If the length of the file name exceeds the limit, excess characters will be omitted and a serial number will be added to the end of the file name.

Specifying the folder

Specify the folder for storing the file.

1 Tap the [Stored to] text box.

If a user name with a "My Folder" setting is selected, "My Folder" of that user will automatically be selected.

2 Tap the key of the folder where you want to store the file, and tap .

If a password has been set for the folder, a password entry screen appears. Enter the password (5 to 8 digit number) using the numeric keys and tap the .

Creating PDF for PC browsing

Tap the [Create PDF for PC Browsing] checkbox to , and a public PDF for PC browsing will be created when the file is saved.



SAVING DOCUMENT DATA ONLY (SCAN TO HDD)

SAVE ON HDD

Storing from Easy Scan

1

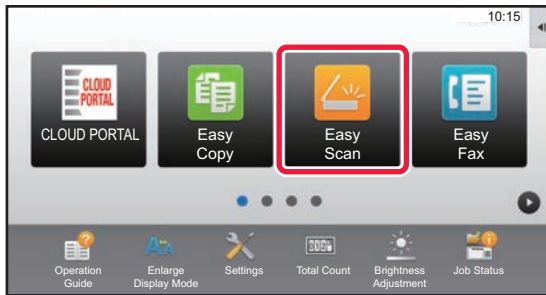

Tap the [Easy Scan] key on the Home screen.

2

Tap [Scan to HDD/USB].

3

Place the original.

Place the original in the document feeder tray of the automatic document feeder, or on the document glass.

- ▶ [AUTOMATIC DOCUMENT FEEDER \(page 1-84\)](#)
- ▶ [DOCUMENT GLASS \(page 1-86\)](#)

4

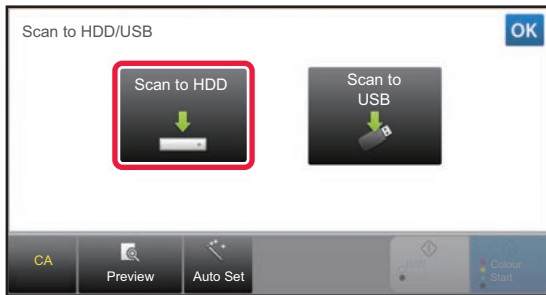

Tap [Scan to HDD].



On the MX-3060V/MX-3070V/MX-3560V/MX-3570V/MX-4060V/MX-4070V/MX-5070V/MX-6070V, you can tap the [Auto Set] key to automatically set appropriate scan settings for the original.

- ▶ [SETTING SCAN SETTINGS AUTOMATICALLY \(Auto Set\) \(MX-3060V/MX-3070V/MX-3560V/MX-3570V/MX-4060V/MX-4070V/MX-5070V/MX-6070V only\) \(page 5-68\)](#)

5

To select settings, tap the key of each desired setting.

- ▶ [IMAGE SEND SEQUENCE \(page 5-12\)](#)



6

Tap the [Colour Start] or [B/W Start] key to start scanning.

A beep will sound to indicate that scanning and file store have ended.

Storing from Document Filing

1

Tap the [HDD File retrieve] key on the Home screen.

2

Tap [Scan to HDD] on the action panel.

3

Place the original.

Place the original in the document feeder tray of the automatic document feeder, or on the document glass.

- [AUTOMATIC DOCUMENT FEEDER \(page 1-84\)](#)
- [DOCUMENT GLASS \(page 1-86\)](#)

4

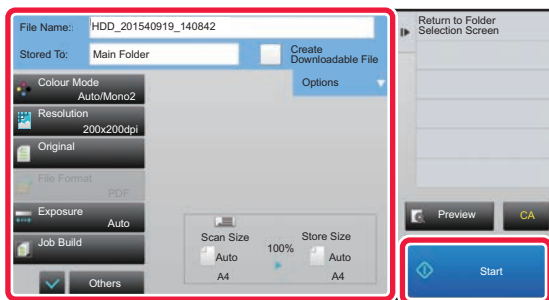

Check the file name and save location, and tap keys for any settings you want to select.



- When the [Create Downloadable File] checkbox is () , the [File Format] key is greyed out and cannot be used. You will not be able to download scan data in the specified format from the Web page.
- For original scan settings, see the explanation of the copy or image send mode.
- If the original is 2-sided, be sure to tap the [Original] key and then tap the [2-Sided Tablet] key or the [2-Sided Book] key as appropriate for the original.
- To set a user name, file attribute, or password, tap [Options].
- When a file is created with [Create Downloadable File] disabled, this setting cannot be enabled later.

5

Tap the [Start] key to start scanning.

A beep will sound to indicate that scanning and file store have ended.



SAVE IN EXTERNAL MEMORY DEVICE

Storing from Easy Scan

1

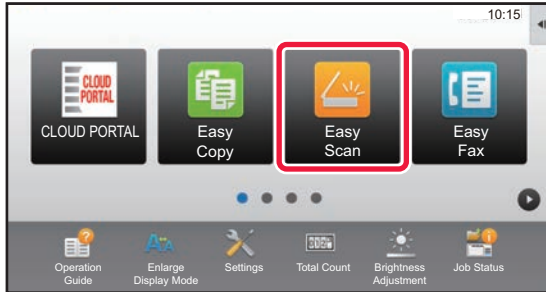

Tap the [Easy Scan] key on the Home screen.

2

Tap [Scan to HDD/USB].

3

Place the original.

Place the original in the document feeder tray of the automatic document feeder, or on the document glass.

- ▶ [AUTOMATIC DOCUMENT FEEDER \(page 1-84\)](#)
- ▶ [DOCUMENT GLASS \(page 1-86\)](#)

4

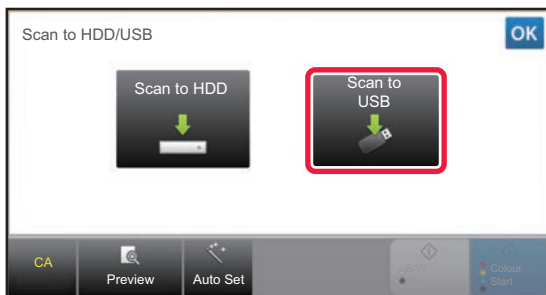

Tap [Scan to USB].



On the MX-3060V/MX-3070V/MX-3560V/MX-3570V/MX-4060V/MX-4070V/MX-5070V/MX-6070V, you can tap the [Auto Set] key to automatically set appropriate scan settings for the original.

- ▶ [SETTING SCAN SETTINGS AUTOMATICALLY \(Auto Set\) \(MX-3060V/MX-3070V/MX-3560V/MX-3570V/MX-4060V/MX-4070V/MX-5070V/MX-6070V only\) \(page 5-68\)](#)

5

To select settings, tap the key of each desired setting.

- ▶ [IMAGE SEND SEQUENCE \(page 5-12\)](#)

6

Tap the [Colour Start] or [B/W Start] key to start scanning.

A beep will sound to indicate that scanning and file store have ended.



Storing from Document Filing

1

Tap the [HDD File retrieve] key on the Home screen.

2

Tap [Scan to External Memory Device] on the action panel.

3

Place the original.

Place the original in the document feeder tray of the automatic document feeder, or on the document glass.

► [AUTOMATIC DOCUMENT FEEDER \(page 1-84\)](#)

► [DOCUMENT GLASS \(page 1-86\)](#)

4

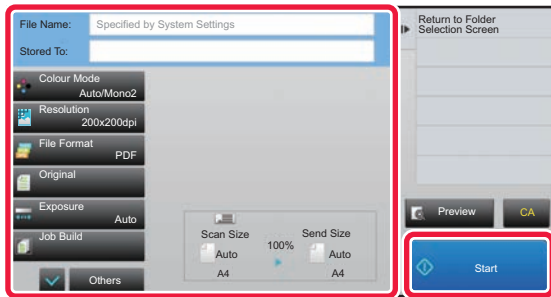

Check the file name and save location, and tap keys for any settings you want to select.



- For original scan settings, see the explanation of the copy or image send mode.
- If the original is 2-sided, be sure to tap the [Original] key and then tap the [2-Sided Tablet] key or the [2-Sided Book] key as appropriate for the original.

5

Tap the [Start] key to start scanning.

A beep will sound to indicate that scanning and file store have ended.



Scan to USB memory device

1

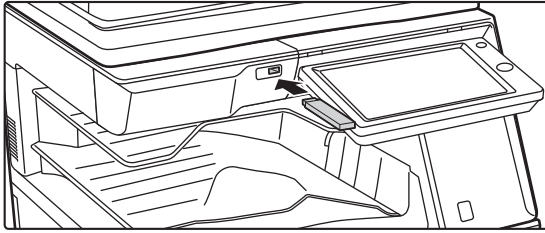

Connect the USB memory device to the machine.

2

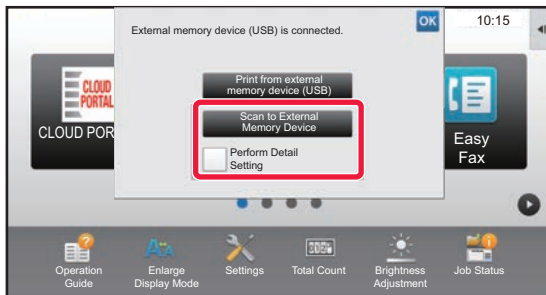

When a screen for selecting the action appears, tap [Scan to External Memory Device].

- To select detailed settings in normal mode, select the [Perform Detail Setting] checkbox .
▶ [NETWORK SCANNER MODE \(page 5-8\)](#)



If the machine/device save screen is open, this screen will not appear.

3

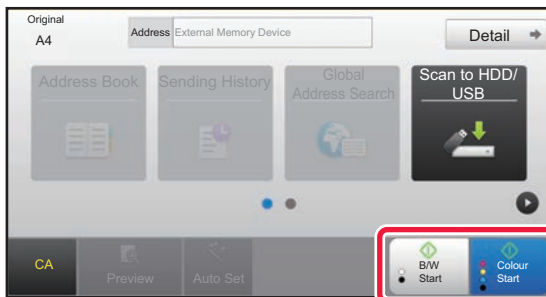

Tap the [Colour Start] key or [B/W Start] key.

To check a preview of a document, tap the [Preview] key.
[PREVIEW SCREEN \(page 1-17\)](#)

4

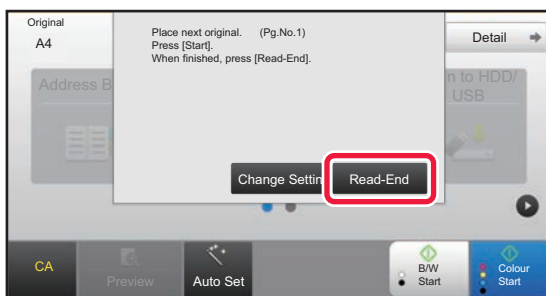

After scanning all originals, tap the [Read-End] key.



When you scan the original using the automatic document feeder, this screen does not appear.



5

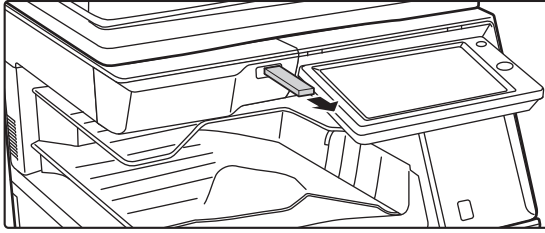

Check the [Sending data has been completed.] message, and remove the USB memory device from the machine.



USING STORED FILES

SEQUENCE FOR USING A STORED FILE

The screens and procedures differ depending on whether or not user authentication is enabled.

The sequence for using a stored file depending on the situation is explained.

For information on user authentication procedures, see "[USER AUTHENTICATION \(page 1-32\)](#)". For information on enabling user authentication and storing user names, see "[USER CONTROL \(page 7-59\)](#)".



Also in setting mode (Web version), you can use document filing. In setting mode (Web version), click [Document Operations] → [Document Filing], and then click the folder that contains the file you wish to use. You can also check a preview of a stored file in setting mode (Web version).

1

Switch to document filing mode.

► [CHANGING MODES \(page 1-16\)](#)

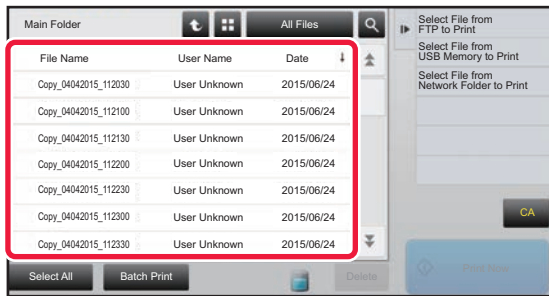
2

Select the file that you wish to retrieve.

When the folder is selected, the files in the folder will appear.

Select the file that you wish to retrieve.

Select a file from the thumbnail images of the stored files.

► [FILE SELECTION SCREEN \(page 6-21\)](#)

► [SELECTING A FILE TO RETRIEVE \(page 6-22\)](#)

Retrieve a file using the search function.

► [FILE SEARCH AND RETRIEVAL \(page 6-33\)](#)

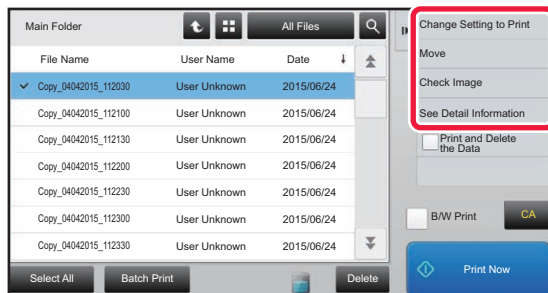
3

Select an operation item.

Select the desired operation and configure settings.

► [FILE SELECTION SCREEN \(page 6-21\)](#)

► [FILE PRINTING \(page 6-22\)](#)

► [FILE TRANSMISSION \(page 6-26\)](#)

► [FILE MOVING \(page 6-27\)](#)

► [DELETE FILE \(page 6-28\)](#)

► [FILE IMAGE CHECKING \(page 6-30\)](#)

► [FILE MERGING \(page 6-31\)](#)



When retention is selected on the printer, reset items that cannot be set for retention do not appear.



FILE SELECTION SCREEN

The file selection screen can be displayed in "List" format or "Thumbnail" format to display thumbnail images of files.

List display mode

Switch the file display mode between list and thumbnail.

Switch the file key displayed for each job type.

Search for a file saved in a folder.

Return to the base screen of document filing mode.

Displays the saved files.

Displays the functions that can be used.

Print in black and white.

Reset all settings.

Start printing immediately.

Select or clear all files. Tapping this key switches the key display mode between [Select All] and [Cancel All].

Tap this key to display the usage status of the machine's built-in hard disk drive.

File Name	User Name	Date
✓ Copy_04042015_112030	User Unknown	2015/06/24
Copy_04042015_112100	User Unknown	2015/06/24
Copy_04042015_112130	User Unknown	2015/06/24
Copy_04042015_112200	User Unknown	2015/06/24
Copy_04042015_112230	User Unknown	2015/06/24
Copy_04042015_112300	User Unknown	2015/06/24
Copy_04042015_112330	User Unknown	2015/06/24

Thumbnail display mode

Switch the file display mode between list and thumbnail.

Displays thumbnails of the saved files.



SELECTING A FILE TO RETRIEVE

1**Tap the [HDD File retrieve] key.**

When user authentication is enabled and "My Folder" is configured by selecting [User Control] in "Settings (administrator)" → [User List], the custom folder specified as "My Folder" opens.

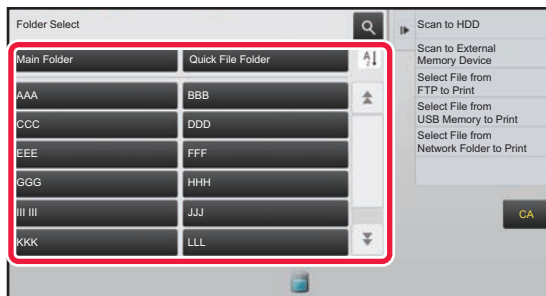
2**Tap the key of the folder that contains the desired file.**

If the folder with a PIN Code is tapped, a PIN Code entry screen will appear.

Enter the PIN Code (5 to 8 digit number) using the numeric keys and tap the **OK**.

3**Tap the key of the desired file.**

If the folder with a PIN Code is tapped, a PIN Code entry screen will appear. Enter the PIN Code (5 to 32 characters) and tap the **OK**.



- Tap the [Print Now] key to print out the file with the settings used for its storage.
- Tap the [Filter by Job] key to display the keys of a particular mode such as copy or scanner mode, enabling quick data search.
- Tap the [File Name] key, the [User Name] key, or the [Date] key to change the order of display of the files.
- Select [User Control] in "Settings (administrator)" → [Authority Group List]. Then, in authority group setting for the users who are currently logged in, select [Job Settings] → [Document Filing] and enable [Display only the Files of Logged-in Users] to display only files stored by the users who are currently logged in.

FILE PRINTING

A file stored using document filing can be retrieved and printed when needed. The settings used when the file was stored are also stored, and thus the file can be printed again using those settings. The file can also be modified before printing by changing the print settings.



- A file saved in black and white or greyscale cannot be printed in colour.
- Print settings that are changed by re-manipulation of the file cannot be saved.
- The printing speed may be somewhat slow depending on the resolution and exposure mode settings of the stored file.
- When retention is selected on the printer, reset items that cannot be set for retention do not appear.



Quick printing

Prints a file with the various settings used when it was saved. Select a file and tap the [Print Now] key.

To delete data after printing, set the [Print and Delete the Data] checkbox to .

To print the file in black and white, select the [B/W Print] checkbox .

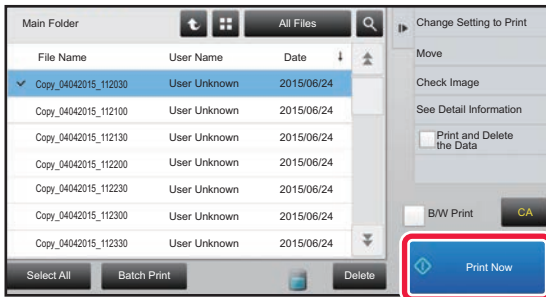

Changing settings before printing

After selecting the desired file, follow the steps below.

► [SELECTING A FILE TO RETRIEVE \(page 6-22\)](#)

1 Tap [Change Setting to Print] on the action panel.

2 Change the print settings.

3 Select the [Delete] or [B/W Print] checkbox when needed.

4 Tap the [Start] key.
The file will be printed.



MULTI-FILE PRINTING

MULTI-FILE PRINTING

1

Select the keys of the multiple files that you wish to print.



- Confidential files cannot be printed simultaneously with other files.
- A file in the currently selected folder cannot be selected simultaneously with a file in a different folder.



- If the job type is changed with the By Job Display key or the screen is changed by  being tapped while a file is selected, the selection of the file will be cancelled.

2

Tap [Print] on the action panel.

3

When not printing with the number of copies at data saving, tap the [Apply the Number from Stored Setting of Each Job.] checkbox to set to .

When printing with the number of copies at data saving without specifying copies, go to step 5.

4

Use   to specify the number of copies.

As required, directly tap the numeric value display key and change the value using the numeric keys.

5

To delete the file after printing, tap the [Delete] checkbox to set to .

6

Tap the [OK] key to start printing.



BATCH PRINTING

1

Tap the [Batch Print] key.

2

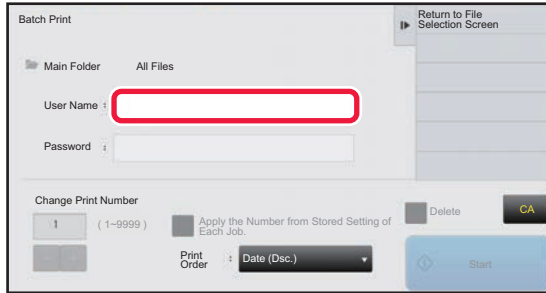

Tap the [User Name] text box.

3

Select the user name.

After selecting the user name, tap **OK**.



If you have selected [System Settings] in "Settings (administrator)" → [Document Filing Settings] → [Condition Settings] → [Batch Print Settings] and disabled the [Selection of [All Users] is not allowed.] checkbox and [Selection of [User Unknown] is not allowed.] checkbox, select the [All Users] key and [User Unknown] key. If you tap the [All Users] key, all files in the folder (the files of all users) are selected. If you tap the [User Unknown] key, all files in the folder with no user name specified are selected.

4

If a password has been established, tap the [Password] key.

Enter the password (5 to 32 characters) and tap **OK**. Only files that have the same password will be selected. If you do not wish to enter a password, go to the next step.

5

When not printing with the number of copies at data saving, tap the [Apply the Number from Stored Setting of Each Job.] checkbox to set to .

When printing with the number of copies at data saving, go to step 7.

6

Use **- +** to specify the number of copies.

As required, directly tap the numeric value display key and change the value using the numeric keys.

7

To automatically delete the file after printing, tap the [Delete] key.



8

Tap the [Start] key to start printing.

If there are no files that match the search conditions, you will return to the file list screen.



If [Delete the Data] on the action panel is tapped, all files that match the current search conditions will be deleted.

FILE TRANSMISSION

The settings used when the file was stored with document filing are stored, and thus the file can be transmitted using those settings. If needed, you can also change the transmission settings to modify the retrieved file.

After selecting the desired file, follow the steps below.

► [SELECTING A FILE TO RETRIEVE \(page 6-22\)](#)



- A file saved in black and white or greyscale cannot be transmitted in colour.
- A stored print job cannot be transmitted. (However, if the job was filed in the printer driver, it can be transmitted if "Rip Style" is set to [RGB]. This settings is accessed by selecting the [Other Settings] button on the [Detailed Settings] tab.)



- These transmission methods require installation of the corresponding options.
- If any of the following other modes were included in the saved file, the file cannot be transmitted. "Stamp", "Photo Repeat", "Multi-Page Enlargement" for copying.
- If any of the following other modes were included in the saved file, the file can be transmitted, but other functions cannot be executed. "Margin Shift", "Transparency Inserts", "Book Copy", "Tab Copy", "Stamp", all "Colour Adjust" menu items, "Centring"
- Depending on the reduction or enlargement ratio used when storing a file, it may not be possible to send the stored file using a selected resolution setting. In this event, try changing the resolution. However, when sending a stored file by Internet fax, transmission may not be possible even if the resolution is changed.
- Files saved in other than Internet Fax mode cannot be sent to an Internet Fax address.

1

Tap [Send] on the action panel.

2

Select settings for sending.

3

Tap the [Start] key.



Only the [B/W Start] key can be used for Fax and Internet Fax.



FILE MOVING

Changes the file storage location. (The file is moved to another folder.)



A file whose property is "Protect" cannot be moved. To move a protected file, change its property to "Sharing" or "Confidential".

After selecting the desired file, follow the steps below.

► [SELECTING A FILE TO RETRIEVE \(page 6-22\)](#)

1

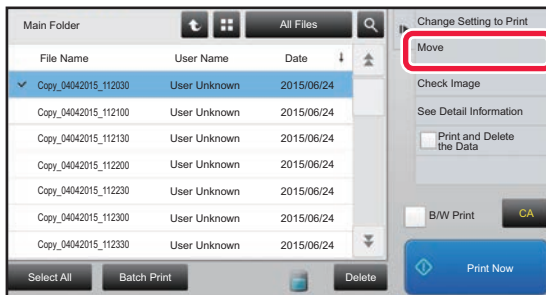

Tap [Move] on the action panel.

2

Tap the [Move to:] key.



- A file cannot be moved to the Quick File folder.
- To change the file name, tap the [File Name] key.

3

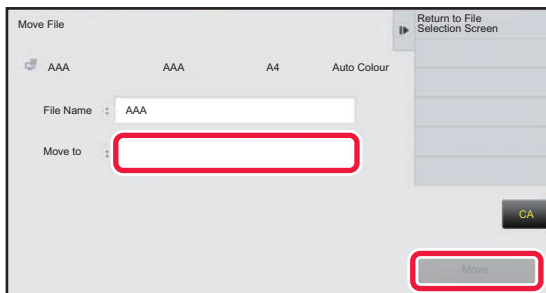

Tap the key of the folder to which you want to move the file.

If the folder with a password is tapped, a password entry screen will appear.

Enter the password (5 to 8 digit number) using the numeric keys and tap the **OK**.



When multiple files are moved, file names cannot be changed.

4

Tap the [Move] key.



DELETE FILE

Stored files that are no longer required can be deleted.



A file whose property is "Protect" cannot be deleted. To delete a protected file, change its property to "Sharing" or "Confidential".

After selecting the desired file, follow the steps below.

► [SELECTING A FILE TO RETRIEVE \(page 6-22\)](#)

1

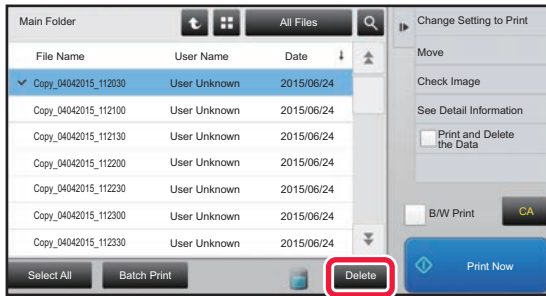

Tap the [Delete] key.

2

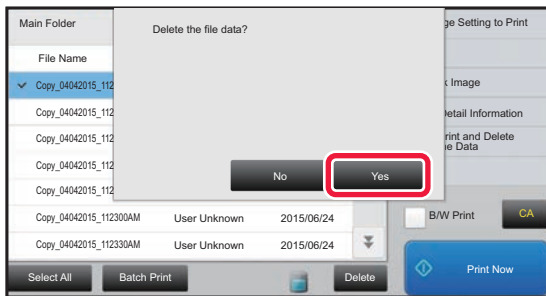

Check the file and then tap the [Yes] key.



Automatic Deletion of File

You can have document filing data in specified folders automatically deleted by specifying the folders and the time. Periodic deletion of files stored in the machine helps to prevent the disclosure of sensitive information and frees space on the hard drive.

When [Delete by Schedule] is selected, you can select every day, every week, or every month for the deletion cycle, and set a scheduled time for each.

When [Delete at Specified Time after Specified Days Have Elapsed] is selected, you can select 1 to 7 days, 10 days, 20 days, or 30 days for the number of elapsed days, and set a scheduled time for each.

Example: Delete the data in the Quick File folder at 9:00 AM 1 day from now.

File Name	Stored Date		Deletion date and time
Document A	05/23/2015 2:22AM	➔	05/25/2015 9:00AM
Document B	05/23/2015 11:59PM		05/25/2015 9:00AM
Document C	05/24/2015 0:01AM		05/26/2015 9:00AM



- **To automatically delete document filing data periodically:**

In "Settings (administrator)", select [System Settings] → [Document Filing Settings] → [Automatic Deletion of File Settings].

- **To check the set deletion cycle:**

In "Settings (administrator)", select [Status] → [List Print] → [List for Administrator], and print a list of the administrator settings including document filing settings.

- **To check information on the folders selected for file deletion:**

In "Settings", select [Status] → [List for User] → [Document Filing Folder List] and print a list of the folders of document filing.



When you specify automatic deletion of document filing data takes place periodically, all files in the specified folders will be deleted when the set time arrives. Exercise care not to store files that you wish to keep in folders specified for file deletion.



FILE IMAGE CHECKING

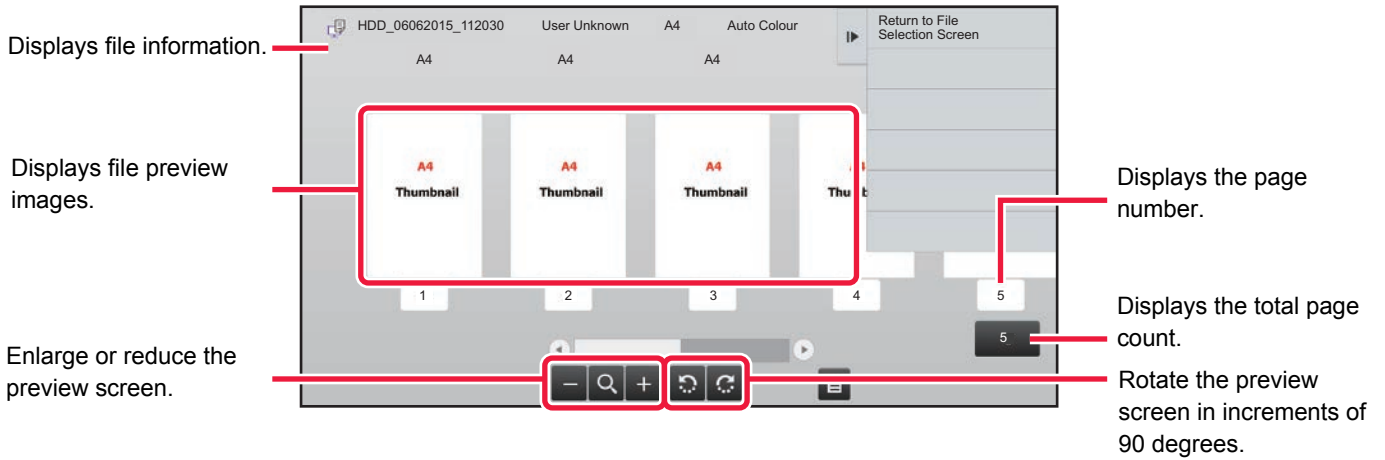

- Depending on the size of the image, part of the image may be clipped off in the image check screen on the touch panel.
- A preview image is an image for display on the touch panel. It will differ from the actual print result.
- The image check screen does not appear when multiple files are selected.

After selecting the desired file, follow the steps below.

▶ [SELECTING A FILE TO RETRIEVE \(page 6-22\)](#)

1

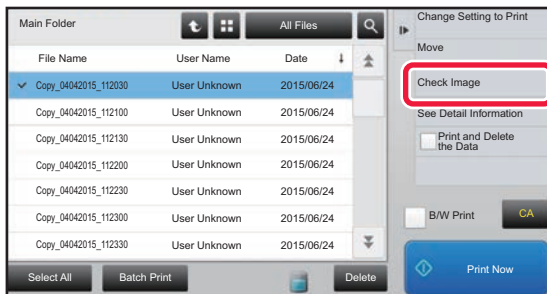

Tap [Check Image] on the action panel.

2

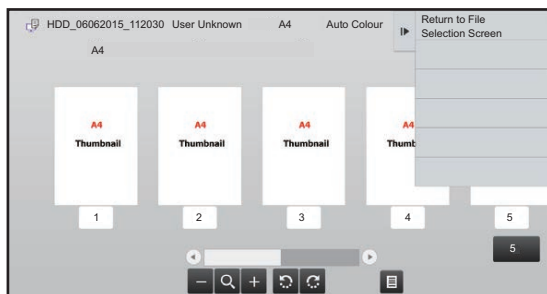

Check the image of the file.



FILE MERGING

You can combine files that have been saved by Document Filing.



- If you have only selected a single file, the [Combine File] key is not displayed.
- The file name is a combination of "the first file name", "a tilde (~)", and "Serial No.". As required, change the file name at a later time.
- The files are joined in the selected order.

After selecting two desired files, follow the steps below.

► [SELECTING A FILE TO RETRIEVE \(page 6-22\)](#)

1

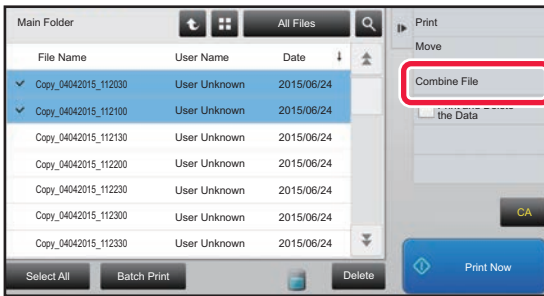

Tap [Combine File] on the action panel.

2

Append file information.

To select the user name, file name, folder, and property setting, see "[File Information \(page 6-12\)](#)".

- [Changing the property \(page 6-12\)](#)
- [Specifying a user name \(page 6-13\)](#)
- [Assigning a file name \(page 6-13\)](#)
- [Specifying the folder \(page 6-13\)](#)
- [Creating PDF for PC browsing \(page 6-13\)](#)

To delete the original file, select the [Delete Original File] checkbox.

3

Tap the [Execute] key.

Combining of files starts, and after the processing is finished, the "Combining complete" message appears.



To cancel the operation

Tap the [CA] key. Note that the operation cannot be cancelled when the original file is being deleted after the files are combined.



RETRIEVING AND USING A FILE FROM THE JOB STATUS SCREEN

Files stored using File and Quick File appear as keys in the job status complete screen. This is convenient when you need to quickly print the saved data of a copy job or quickly send a saved fax to another destination.

1

Tap the job status display.

2

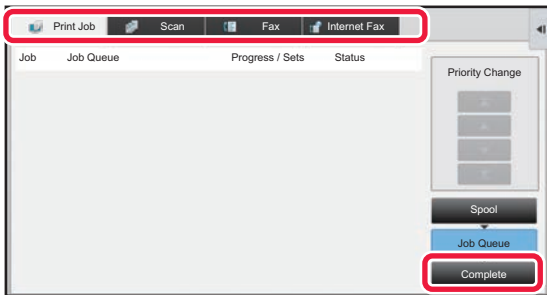

Tap the tab with a file to be retrieved, and tap the [Complete] key.

3

Tap the key of the desired file from the completed job.

A file that has been processed by Quick File or File can be selected for a job in the retrieve operation.

4

Tap [Send] or [Change Setting to Print] on the action panel.

- ▶ [FILE TRANSMISSION \(page 6-26\)](#)
- ▶ [FILE PRINTING \(page 6-22\)](#)



To view detailed information on a file, select the file, and then tap [Check Details of Selected Job] on the action panel.



FILE SEARCH AND RETRIEVAL

When there are many stored files, it may take some time to locate a file. The search function of document filing mode can be used to find a file quickly.

Searching is possible even when you only know part of the file name or folder name. As required, a folder can also be specified as a search range.

Example: Only part of a file name is known: "Conference"

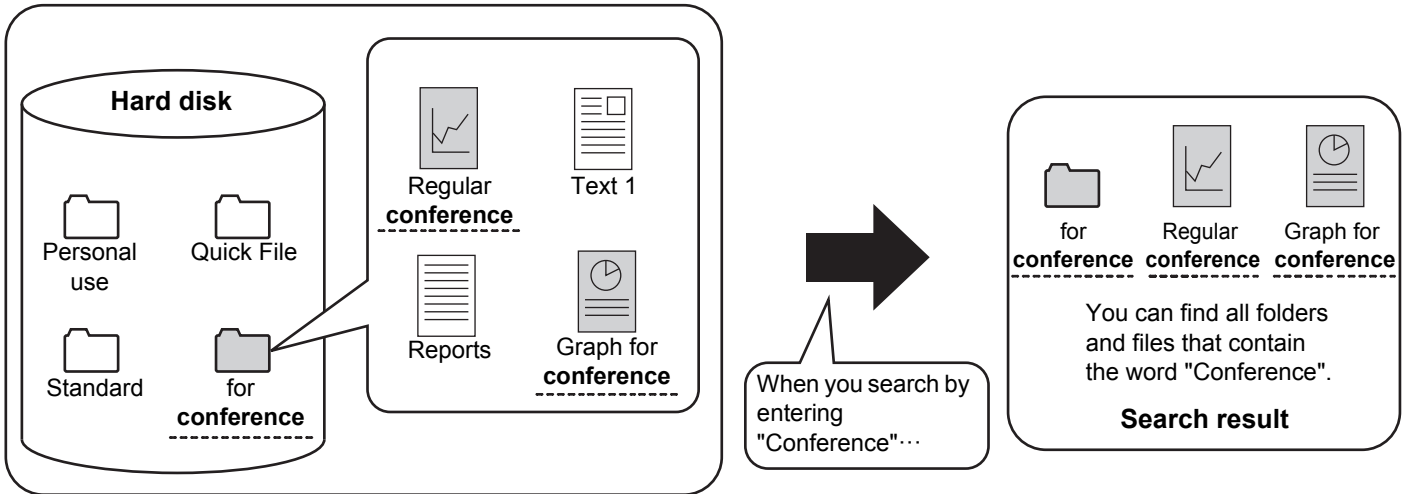

1

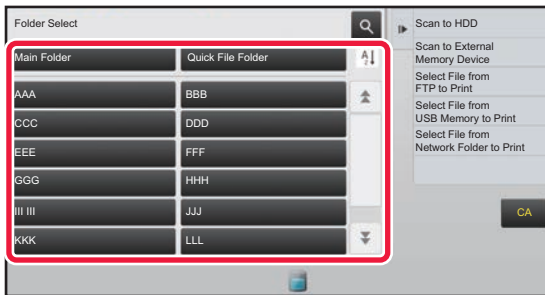

To search for a specific folder, tap its key.



If the folder with a password is tapped, a password entry screen will appear. Enter the password (5 to 8 digit number) using the numeric keys.

2

Tap .



3

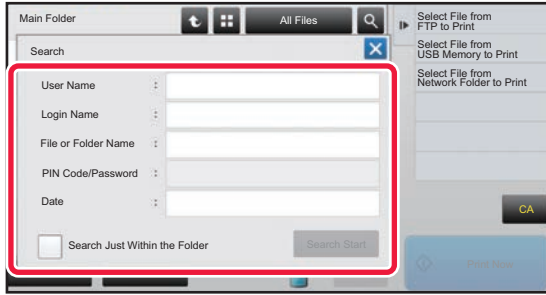

Select search conditions.

Tap each text box and set the search condition.

To search for the current folder, set the [Search Just Within the Folder] checkbox to .

[User Name]

Search using the user name.

Select a user on the user selection screen that appears, and then tap **OK**.

[Login Name]

Search using the login name.

Enter the login name on the soft keyboard that appears and tap the [OK] key.

[File or Folder Name]

Search using the file name or folder name.

Enter the file name or folder name on the soft keyboard that appears and tap the [OK] key.

[PIN Code/Password]

Search for files that have a password set.

Enter the password with the soft keyboard that appears, and tap the [OK] key.

[Date]

Search using the date when the file was created.

When you have selected [Today] or [Date Set], set the time and date.

4

Tap the [Search Start] key.

A list of the files that match your search conditions will appear. Select the desired file from the list. The job settings screen will appear.

To return to the base screen of document filing mode, tap the [CA] key.

To return to the file search screen, tap the [Search Again] key.



- When you search using [File or Folder Name], custom folders that match the search characters will also appear in the list. When a folder key is tapped, a list of the files in the folder appears. Tap the desired file in the list.
- Also in setting mode (Web version), you can use the file search function. Click [Document Operations] in "Settings (Web version)" → [Document Filing] → [Search].



PRINTING AN EXTERNAL FILE

A file stored in the FTP server, USB memory device, or network folder of a PC can be printed. The file can also be modified before printing by changing the print settings.

On the action panel, tap [Select File from FTP to Print], [Select File from USB Memory to Print] or [Select File from Network Folder to Print].

For more information, see "[PRINTING WITHOUT THE PRINTER DRIVER \(page 3-80\)](#)".



SYSTEM SETTINGS

SETTING MODE

SETTING MODE LIST

SETTING MODE LIST	7-5
• Status	7-5
• Address Book	7-5
• Document Operations	7-6
• User Control	7-6
• System Settings	7-9

STATUS

Status	7-48
• Machine Identification	7-48
• Total Count	7-49
• Device Status	7-49
• Network Status	7-50
• Firmware Version	7-50
• Power Reset	7-51
• Data List	7-51

ADDRESS BOOK

Address Book	7-53
• Category Setting	7-55

DOCUMENT OPERATIONS

Document Operations	7-56
• Document Filing	7-56
• Submit Print Job	7-58

USER CONTROL

User Control	7-59
• User List	7-59
• Custom Index	7-62
• Organization /Group List	7-62
• Default Settings	7-62
• Pages Limit Group	7-68
• Machine Page Limit Setting	7-68
• Authority Group	7-69
• Favourite Operation Group	7-73
• User Count	7-75

• Billing Code Setting	7-77
• Card Setting	7-79

SYSTEM SETTINGS

Home Screen Settings	7-80
• Condition Settings	7-80
• Icon	7-80
• Background Image	7-81
• Home Screen Registration	7-81
Copy Settings	7-82
• Condition Settings	7-82
• Initial Status Settings	7-85
• Text /Image Printing	7-85
Printer Settings	7-86
• Condition Settings	7-86
• Interface Settings	7-87
• Initial Status Settings	7-88
• PCL Settings	7-89
• PostScript Settings	7-90
• OOXML Settings	7-90
• Print Release Settings	7-90
• E-mail Print Settings	7-91
• Direct Print Settings (FTP)	7-91
• Direct Print Settings (Network Folder)	7-92
• Print Setting from PC/Mobile Terminal	7-92
Image Send Settings	7-93
• Common Settings	7-93
• Scan Settings	7-97
• Internet Fax Settings	7-102
• Fax Data Receive/Forward (Manual)	7-108
• Inbound Routing (Forwarding/Storing) Settings	7-109
• Inbound Routing (Storage) Settings	7-111
• Metadata Settings	7-112
Document Filing Settings	7-113
• Condition Settings	7-113
• Document Filing Control	7-115
• Automatic Deletion of File Settings	7-115
Sharp OSA Settings	7-116
• Condition Settings	7-116
• Standard Application Settings	7-116
• Receiving Application Setting	7-117
• External Accounting Application Settings	7-117
• Embedded Application Settings	7-118
• Polling Setting	7-118





Common Settings	7-119
• Paper Settings	7-119
• Paper Type Registration	7-121
• Operation Settings	7-122
• Keyboard Settings	7-126
• Device Control	7-127
• Enable/Disable Settings	7-130
• Machine Identification Settings	7-134
• Clock Adjust.	7-135
• Product Key	7-136
• Custom Link Setting	7-136
Network Settings	7-137
• Quick Settings	7-137
• Network Name Setting	7-139
• Protocol Settings	7-140
• Services Settings	7-141
• Print Port Settings	7-144
• External Print Services Settings	7-144
• External Service Connect	7-146
• LDAP Settings	7-147
• Active Directory Settings	7-148
• Public Folder / NAS Setting	7-148
• Proxy Setting	7-149
• Wireless Settings	7-149
• Easy Connection Setting	7-151
• Device Web Page Setting	7-152
Security Settings	7-153
• Restrict Device Web Page Access Via Password	7-153
• Change Password	7-153
• Port Control	7-154
• Filter Setting	7-154
• SSL Settings	7-154
• S/MIME Settings	7-155
• IPsec Settings	7-156
• IEEE802.1X Setting	7-157
• Security Control	7-159
• Document Administration Function	7-159
• Hidden Pattern Print Setting	7-160
• Tracking Information Print	7-161
• Audit Log	7-161
Energy Save	7-162
• Eco Setting	7-162
• Eco Scan Setting	7-166
• Energy Saving Pattern List	7-166
• Specific Date Operation Settings	7-167
• Power ON/OFF Schedule Setting	7-168
• Toner Save Mode	7-168

System Control	7-169
• Job Log	7-169
• Data Import/Export (CSV Format)	7-169
• Storage Backup	7-169
• Device Cloning	7-170
• Address Book Forward	7-170
• Filing Data Backup	7-170
• Storing/Calling of System Settings	7-171
• Reset Settings	7-171
• Optimization of Hard Disk	7-171
• E-mail Alert and Status	7-172
Image Quality Adjustment	7-173
• Collective Adjustment	7-173
• Copy Image Quality	7-174
• Print Image Quality	7-174
• Scan Image Quality	7-175
• Colour Profile Settings	7-175
• Common Functions	7-176
• Remove Toner Cartridge	7-176
Initial Installation Settings	7-177

SETTING MODE FOR FAX

Image Send Settings	7-180
• Fax Settings	7-180
• F-Code Memory Box	7-190
• Fax Data Receive/Forward (Manual)	7-191



SETTING MODE

"Settings" allows management of various functions that will make it easier to use the machine, such as default registration for each function, network connection setting, and log check of operation status.

Setting mode can also be selected using the Web browser by accessing the machine from a PC connected to the same network as the machine.



• Administrator password

To maintain security, the machine administrator should promptly change the password after the machine is purchased. (For the default administrator password, see Start Guide.) To change the password, see "[Change Password \(page 7-153\)](#)".

* To ensure a high level of security, change the password at regular intervals.

For fax settings, see "[SETTING MODE FOR FAX \(page 7-178\)](#)".

Displaying the setting mode on the machine

1

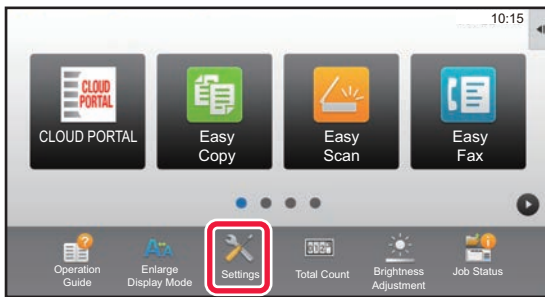

Tap the [Settings] key.

Tap the [Settings] key on the home screen.

The setting mode screen appears on the touch panel.

The setting menu appears at the top of the displayed screen.

Tap the setting in the menu that you want to configure.

For details of the settings, see the explanation for each item.

2

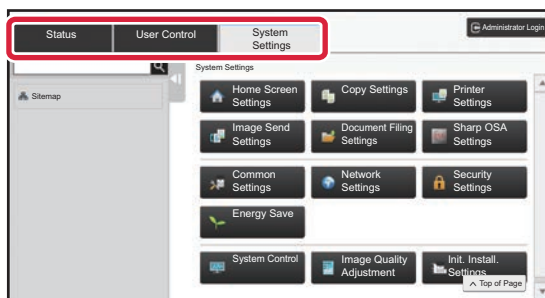

On the upper tab, tap the item that you want to set.

The setting menu appears on the left side of the displayed screen.

Tap the setting in the menu that you want to configure.

When you tap the [System Settings] tab, item keys appear on the screen.

When you tap the key of an item, a setting item menu appears.

(When you tap the [Image Send Settings] key, further item keys appear.)



• To quit the setting mode, tap the [Cancel] key in the upper right corner of the screen.

• For details on login procedures when user authentication is enabled, see "[USER AUTHENTICATION \(page 1-32\)](#)".



Displaying the setting mode (Web version)

When the machine is connected to the network, access the built-in Web server of the machine using the PC's Web browser.

From the setting mode of the machine, print the IP address of the machine and enter the address on the PC's Web browser.

1

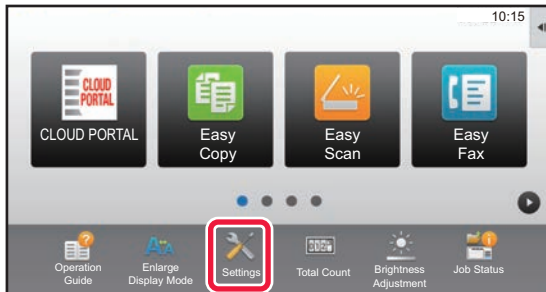

Tap the [Settings] key.

2

Tap [Status] → [Data List] → [List for User] from the menu.

3

Enter "✓" in [NIC Page] and tap the [Print] key.

Check the IP address on the printed list.

4

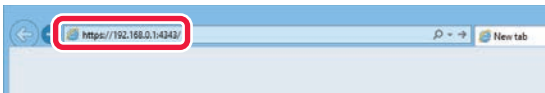

Start the Web browser on the PC, and enter the IP address of the machine

Start a Web browser on a PC on the same network the machine is on, and enter the IP address of the machine.

Recommended Web browsers:

Internet Explorer: 9 or later (Windows®)

Firefox: 37 or later (Windows®)

Safari: 4.0 or later (Mac OS®)

Chrome: 42 or later (Windows®)

Depending on the machine settings, user authentication may be required to display the setting mode (Web version).

For password and other information required for user authentication, contact the administrator of the machine.



SETTING MODE LIST

SETTING MODE LIST

The following is a list of setting mode items, factory default settings and restrictions for each item.



- Depending on the machine specifications and peripheral devices installed, it may not be possible to use some settings.
- Some setting items can only be configured on the Web page.

Status

U: General user; A: System administrator/Administrator

Setup Items	Factory default setting	U	A
■ Status (page 7-48)			
● Machine Identification (page 7-48)	–	Yes*	Yes
● Total Count (page 7-49)	–	Yes	Yes
● Device Status (page 7-49)	–	Yes	Yes
● Network Status (page 7-50)	–	Yes	Yes
● Firmware Version (page 7-50)	–	No	Yes
● Power Reset (page 7-51)	–	No	Yes
● Data List (page 7-51)	–	Yes	Yes
▶ List for User	–	Yes	Yes
▶ List for Administrator	–	No	Yes

* Some settings can only be configured by the administrator.

Address Book

U: General user; A: System administrator/Administrator

Setup Items	Factory default setting	U	A
■ Address Book (page 7-53)			
● Address Book (page 7-53)*1	–	Yes	Yes
● Category Setting (page 7-55)*2	–	Yes	Yes

*1 This setting is configured in setting mode on the web page.

*2 Set the Category Setting in System Settings→Image Send Settings→Common Settings→Category Setting of the machine's setting mode.



Document Operations

U: General user; A: System administrator/Administrator

Setup Items	Factory default setting	U	A
■ Document Operations (page 7-56) *1			
● Document Filing (page 7-56)		Yes	Yes
▶ Main Folder	–	Yes	Yes
▶ Quick File Folder	–	Yes	Yes
▶ Custom Folder*2	–	Yes	Yes
▶ My Folder*3	–	Yes	Yes
▶ Search	–	Yes	Yes
▶ File Batch Print	–	Yes	Yes
● Submit Print Job (page 7-58)	–	Yes	Yes

*1 This setting is configured in setting mode on the web page.

*2 Set the Category Setting in System Settings→Document Filing Settings→Document Filing Control of the machine's setting mode.

*3 This appears when My Folder is set.

User Control

U: General user; A: System administrator/Administrator

Setup Items	Factory default setting	U	A
■ User Control (page 7-59)			
● User List (page 7-59)	–	No	Yes
● Custom Index (page 7-62)	–	No	Yes
● Organization /Group List (page 7-62)	–	No	Yes
● Default Settings (page 7-62)		No	Yes
▶ User Authentication	Disabled	No	Yes
▶ Authentication Server Settings	Local	No	Yes
▶ Default Network Authentication Server Setting*1	Not Set	No	Yes
▶ Perform network server access control	Disabled	No	Yes
▶ Authentication Method Setting	Authenticate a User by Login Name and Password	No	Yes
▶ Device Account Mode Setting		No	Yes
◆ Device Account Mode	Disabled	No	Yes
◆ Allow Login by Different User	Disabled	No	Yes
▶ Login User	–	No	Yes
▶ Cache User Information	Enabled	No	Yes
◆ Cache Period	Unlimited	No	Yes
◆ Cache Password for Authentication	Enabled	No	Yes



Setup Items	Factory default setting	U	A
▶ Store user authentication information for External Connect	Enabled	No	Yes
▶ Card Setting		No	Yes
◆ Use IC Card for Authentication	Disabled	No	Yes
◆ Request Password at IC Card Authentication	Only Card Authentication Approved	No	Yes
◆ Automatic Logout with a Card	Disabled	No	Yes
◆ Authentication Method Setting	Disabled	No	Yes
▶ Actions when the Limit of Pages for Output Jobs*2	Job is Completed even when the Limit of Pages is Reached	No	Yes
▶ A Warning when Login Fails*2	Disabled	No	Yes
▶ Disabling of Printing by Invalid User*2	Disabled	No	Yes
▶ Allow Remote Scanner Using Before Login.	Disabled	No	Yes
▶ Automatically print stored jobs after login	Disabled	No	Yes
▶ Display Usage Status after Login*2	Enabled	No	Yes
▶ Login Name Display	Display login name	No	Yes
▶ Include Job Status in user authentication	Disabled	No	Yes
▶ Disable display/change of other users' information in the job status	Disabled	No	Yes
▶ Automatic Logout Setting	Enabled (60sec.)	No	Yes
▶ Case sensitivity of login name is enabled.	Enabled	No	Yes
▶ Apply login name to the user name of network folder	Enabled	No	Yes
▶ Edit Help Display of Login Screen	–	No	Yes
▶ User Information Print	User List	No	Yes
▶ Reset Counter After Sending E-mail Status	Disabled	No	Yes
● Pages Limit Group (page 7-68)	–	No	Yes
● Machine Page Limit Setting (page 7-68)	–	No	Yes
● Authority Group (page 7-69)	–	No	Yes
● Favourite Operation Group (page 7-73)	–	No	Yes
▶ Favourite Operation Group List	–	No	Yes
▶ Favorite Key List*3	–	No	Yes
▶ Home Screen List	–	No	Yes
● User Count (page 7-75)		No	Yes
▶ View User Count	–	No	Yes
▶ Save User Count*3	–	No	Yes
● Billing Code Setting (page 7-77)		No	Yes
▶ Administration Settings	–	No	Yes
◆ Use Billing Code	Disabled	No	Yes



Setup Items	Factory default setting	U	A
◆ Default Code Setting	usecode	No	Yes
◆ Remember Billing Code Between Modes	Disabled	No	Yes
◆ Disable Change of Billing Code	Disabled	No	Yes
◆ Apply Default Code when Billing Code not entered Billing Code not Entered	Disabled	No	Yes
◆ Disable Billing Code for Selected Applications		No	Yes
• Sharp OSA	All Invalid	No	Yes
◆ Billing Code Display Name Setting		No	Yes
• Main Code Display Name	Default	No	Yes
• Sub Code Display Name	Default	No	Yes
▶ Main Code List	–	No	Yes
▶ Sub Code List	–	No	Yes
● Card Setting (page 7-79)		No	Yes
▶ Card Area Setting (page 7-79)		No	Yes
◆ Check System Code only in FeliCa User Area mode	Disabled	No	Yes
◆ Check Facility Code in HID mode	Disabled	No	Yes
◆ Importing from the setup file	–	No	Yes
◆ Card Scan Test	Disabled	No	Yes
▶ Card Type / Card Reader Settings (page 7-79)		No	Yes
◆ Card Type / Card Reader	200	No	Yes
◆ Card Reader Device Registration*4	–	No	Yes

*1 Appears when [LDAP] is set in "Authentication Settings".

*2 Appears when "Settings (administrator)" - [Sharp OSA Settings] → [External Accounting Application Settings] → [Set Authentication Server (Server 1)] is enabled.

*3 This setting is configured in setting mode on the web page.

*4 This setting is configured in setting mode on the machine.



System Settings

Home Screen Settings

U: General user; A: System administrator/Administrator

Setup Items	Factory default setting	U	A
● Home Screen Settings (page 7-80)			
▶ Condition Settings	–	No	Yes
▶ Icon*	–	No	Yes
▶ Background Image*	–	No	Yes

* In the machine's setting mode, this can be set with a USB memory device connected.

Copy Settings

U: General user; A: System administrator/Administrator

Setup Items	Factory default setting	U	A
● Copy Settings (page 7-82)			
▶ Condition Settings		No	Yes
◆ Rotation Copy Setting	Rotation Copy	No	Yes
◆ Add or Change Extra Preset Ratios	–	No	Yes
◆ Setting a Maximum Number of Copies	9999	No	Yes
◆ Initial Margin Shift Setting		No	Yes
• Side 1	10mm (1/2")	No	Yes
• Side 2	10mm (1/2")	No	Yes
◆ Erase Width Adjustment		No	Yes
• Edge Clearance Width	10mm (1/2")	No	Yes
• Centre Clearance Width	10mm (1/2")	No	Yes
◆ InitialN-Up Setting	Off	No	Yes
• Layout	Left to Right/Right, and Down	No	Yes
• Border	No Print	No	Yes
◆ Card Shot Settings		No	Yes
• Original Size	X: 86 mm (3-3/8"), Y: 54 mm (2-1/8")	No	Yes
• Fit to Page	Disabled	No	Yes
◆ Initial Tab Copy Setting	10mm (1/2")	No	Yes
◆ Disabling of Registration/Deletion of Program	Disabled	No	Yes
◆ Disabling of Bypass-Tray in Duplex Copy	Disabled	No	Yes
◆ Disabling of Auto Paper Selection	Disabled	No	Yes
◆ Auto Selection Setting of Tray that is Supplied the Paper	Disabled	No	Yes



Setup Items	Factory default setting	U	A
◆ Disabling Registration of Custom Image	Disabled	No	Yes
◆ Disabling sending while copying	Disabled	No	Yes
◆ High Quality Scan from Document Feeder (B/W)	Disabled	No	Yes
◆ Quick Scan from Document Glass (B/W)	Disabled	No	Yes
◆ Auto Clear Before Copy Execution Also	Disabled	No	Yes
► Initial Status Settings		No	Yes
◆ Colour Mode	Full Colour	No	Yes
◆ Image Orientation	Portrait	No	Yes
◆ Paper Tray	Varies depending on the machine configuration	No	Yes
◆ Exposure Type	Auto	No	Yes
• Copy of Copy	Disabled	No	Yes
• Colour Tone Enhancement	Disabled	No	Yes
◆ Copy Ratio	100%	No	Yes
• Select magnification automatically according to paper size, when paper tray is selected.	Disabled	No	Yes
◆ 2-Sided Copy	1-Sided→1-Sided	No	Yes
◆ Original Binding	Book	No	Yes
◆ Output Binding	Book	No	Yes
◆ Output	Auto	No	Yes
◆ Output Tray	Varies depending on the machine configuration	No	Yes
◆ Offset	Enabled	No	Yes
◆ Staple Sort*1	–	No	Yes
◆ Staple Position*1	–	No	Yes
◆ Separator Page		No	Yes
• Insert Before Job	Disabled	No	Yes
• Insert After Job	Disabled	No	Yes
◆ Punch*2	–	No	Yes
► Text /Image Printing		No	Yes
◆ Text Settings (Stamp)	–	No	Yes
◆ Custom Stamp	–	No	Yes
◆ Custom Watermark	–	No	Yes

*1 When an inner finisher/finisher/finisher (large stacker)/saddle stitch finisher/saddle stitch finisher (large stacker) is installed.

*2 When an inner finisher/finisher/finisher (large stacker)/saddle stitch finisher/saddle stitch finisher (large stacker) is installed and a punch module is installed.



Printer Settings

U: General user; A: System administrator/Administrator

Setup Items	Factory default setting	U	A
● Printer Settings (page 7-86)			
▶ Condition Settings		No	Yes
◆ Prohibit Notice Page Printing	Enabled	No	Yes
◆ Prohibit Test Page Printing	Disabled	No	Yes
◆ A4/Letter Size Auto Change	Disabled	No	Yes
◆ Bypass Tray Settings		No	Yes
• Enable Detected Paper Size in Bypass Tray	Disabled	No	Yes
• Enable Selected Paper Type in Bypass Tray	Disabled	No	Yes
• Exclude Bypass-Tray from Auto Paper Select	Disabled	No	Yes
◆ Job Spool Queuing	Enabled	No	Yes
◆ Disabling of USB Memory Direct Print	Disabled	No	Yes
◆ Disabling of Network Folder Direct Print	Disabled	No	Yes
◆ Disabling sending while printing	Disabled	No	Yes
▶ Interface Settings		No	Yes
◆ Hexadecimal Dump Mode	Disabled	No	Yes
◆ I/O Timeout	60sec.	No	Yes
◆ Enable Network Port	Enabled	No	Yes
◆ Network Port Emulation Switching	Auto	No	Yes
◆ Port Switching Method	Switch at End of Job	No	Yes
▶ Initial Status Settings		Yes	Yes
◆ Copies	1	Yes	Yes
◆ Orientation	Portrait	Yes	Yes
◆ Paper Size	A4 (8-1/2" x 11")	Yes	Yes
◆ Output Tray	Auto	Yes	Yes
◆ Paper Type	Plain	Yes	Yes
◆ Resolution Setting	600dpi (High Quality)	Yes	Yes
◆ Disable Blank Page Print	Enabled	Yes	Yes
◆ 2-Sided Print	1-Sided	Yes	Yes
◆ Colour Mode	Auto	Yes	Yes
◆ N-Up	1-Up	Yes	Yes
◆ Fit To Page	Enabled	Yes	Yes
◆ Output	Varies depending on the machine configuration	Yes	Yes
• Print per Unit	Enabled	Yes	Yes
• Separator Page		Yes	Yes
- Insert Before Job	Disabled	Yes	Yes
- Insert After Job	Disabled	Yes	Yes
• Staple Sort*2	Disabled	Yes	Yes



Setup Items	Factory default setting	U	A
• Punch*3	Disabled	Yes	Yes
• Fold*4	Disabled	Yes	Yes
- Fold Multiple Sheets Together*5	Disabled	Yes	Yes
◆ Quick File	Disabled	Yes	Yes
▶ PCL Settings		Yes	Yes
◆ PCL Symbol Set Setting	PC-8	Yes	Yes
◆ PCL Font Setting	Internal Font, 0: Courier	Yes	Yes
◆ PCL Line Feed Code	0.CR=CR; LF=LF; FF=FF	Yes	Yes
◆ Wide A4	Disabled	Yes	Yes
▶ PostScript Settings*6		Yes	Yes
◆ Screen Settings	Standard	Yes	Yes
◆ Print PS Errors	Disabled	Yes	Yes
◆ Binary Processing	Disabled	Yes	Yes
▶ OOXML Settings*7		Yes	Yes
◆ Print What	Selected Sheet	Yes	Yes
▶ Print Release Settings	For information about each of the print release settings, see "Print Release Settings Guide".	No	Yes
▶ E-mail Print Settings		No	Yes
◆ E-mail Print	Disabled	No	Yes
◆ POP3 Server	–	No	Yes
◆ Port Number	110	No	Yes
◆ POP Authentication	Disabled	No	Yes
◆ User Name	–	No	Yes
◆ Password	–	No	Yes
• Change Password	Disabled	No	Yes
◆ Check Interval	5 minutes	No	Yes
◆ Enable SSL	Disabled	No	Yes
◆ Connection Test	–	No	Yes
▶ Direct Print Settings (FTP)		No	Yes
▶ Direct Print Settings (Network Folder)	–	No	Yes
▶ Print Setting from PC/Mobile Terminal		No	Yes
◆ FTP Print	Enabled	No	Yes
◆ Port Number	21	No	Yes
◆ Use Banner	Disabled	No	Yes

*1 When an inner finisher is installed.

*2 When an inner finisher/finisher/finisher (large stacker)/saddle stitch finisher/saddle stitch finisher (large stacker) is installed.

*3 When an inner finisher/finisher/finisher (large stacker)/saddle stitch finisher/saddle stitch finisher (large stacker) is installed and a punch module is installed.

*4 When a saddle stitch finisher/saddle stitch finisher (large stacker) is installed.

*5 When a saddle stitch finisher (large stacker) is installed.

*6 When a PS3 expansion kit is installed. (MX-2630N/MX-3050V/MX-3550V/MX-4050V/MX-5050V/MX-6050V)

*7 When a direct print expansion kit is installed. (MX-2630N/MX-3050V/MX-3550V/MX-4050V/MX-5050V/MX-6050V)



Image Send Settings

Common Settings

U: General user; A: System administrator/Administrator

Setup Items	Factory default setting	U	A
● Common Settings (page 7-93)			
▶ Condition Settings		No	Yes
◆ Hold settings for a while after scanning has been completed	Disabled	No	Yes
◆ Job Auto Start Time During Scanning	60sec.		
◆ Default Display Setting	E-mail (Fax when the facsimile expansion kit is installed)	No	Yes
◆ Address Book Default Selection		No	Yes
• Higher priority is given to the display of address book.	Disabled	No	Yes
• Apply Addresses of Sending Modes Only	Enabled	No	Yes
◆ Category Displayed as Default	None	No	Yes
◆ Display all address type regardless of the mode being displayed currently.	Disabled	No	Yes
◆ Enlarge Address Book	Enabled	No	Yes
◆ Image Orientation	Portrait	No	Yes
◆ Preview Setting		No	Yes
• Received Data Image Check Setting	Disabled	No	Yes
• Default List/Thumbnail Display		No	Yes
- Fax/I-Fax Reception Data* ^{1, *2}	Thumbnail	No	Yes
◆ Default Exposure Settings	Auto	No	Yes
◆ Default Original Image Type	Text	No	Yes
◆ Sending the same image sent in Fax mode* ¹	Disabled	No	Yes
◆ Be sure to press Next Address Key ([+]) before selecting the next address.	Disabled	No	Yes
◆ Scan Complete Sound Setting	Middle	No	Yes
◆ Disable Switching of Display Order	Disabled	No	Yes
◆ Hold Setting for Received Data Print	Disabled	No	Yes
◆ Default Verification Stamp* ³		No	Yes
• E-mail/Scan/Data Entry	Disabled	No	Yes
• Fax/Internet Fax* ^{1, *2}	Disabled	No	Yes
◆ Erase Width Adjustment		No	Yes
• Edge Clearance Width	10mm (1/2")	No	Yes
• Centre Clearance Width	10mm (1/2")	No	Yes
◆ Time Specified Output of Received Data	Disabled	No	Yes
▶ Enable/Disable Settings		No	Yes



Setup Items	Factory default setting	U	A
◆ Settings to Disable Registration		No	Yes
• Disable Registering Destination from Operation Panel	All Invalid	No	Yes
• Disable Registering Destination on Web Page	All Invalid	No	Yes
• Disable Registration/Delection of All Program Items	Disabled	No	Yes
• Disable Registration of Memory Box*1	All Invalid	No	Yes
• Disable Destination Registration Using Global Address Search	All Invalid	No	Yes
• Disable Registration Using Network Scanner Tool	Disabled	No	Yes
• Disabling of Forwarding via Network	Disabled	No	Yes
◆ Settings to Disable Transmission		No	Yes
• Disable [Resend] on Fax/Image Send Mode*1, *2	Disabled	No	Yes
• Disable Selection from Address Book	All Invalid	No	Yes
• Disable Direct Entry	All Invalid	No	Yes
• Disabling of PC Scan	Disabled	No	Yes
• Disable Storing to External Memory Device	Disabled	No	Yes
• Disable PC-I-Fax Transmission*2	Disabled	No	Yes
• Disable PC-Fax Transmission*1	Disabled	No	Yes
• Disabling of Find My Address	Disabled	No	Yes
► Own Name and Destination Set		No	Yes
◆ Sender Data Registration		No	Yes
• Sender Name	–	No	Yes
• Sender Fax Number	–	No	Yes
• I-Fax Own Address	–	No	Yes
◆ Registration of Own Name Select	–	No	Yes

*1 When a facsimile expansion kit is installed.

*2 When an internet fax expansion kit is installed.

*3 When a stamp unit is installed.

Scan Settings

Setup Items	Factory default setting	U	A
● Scan Settings (page 7-97)			
► Scan Settings		No	Yes
◆ Initial Status Settings		No	Yes
• Default Colour Mode Settings		No	Yes
- Scanner Common	Auto: Mono2	No	Yes
+ Disable Change of B/W Setting in Auto Mode	Disabled	No	Yes
- E-mail	Auto: Mono2	No	Yes
+ Disable Change of B/W Setting in Auto Mode	Disabled	No	Yes



Setup Items	Factory default setting	U	A
• Initial File Format Setting		No	Yes
- Scanner Common		No	Yes
+ File Type	PDF	No	Yes
+ OCR*	Disabled	No	Yes
+ Black & White	Compression Mode: MMR (G4)	No	Yes
+ Colour/Greyscale	Compression Ratio: Medium	No	Yes
+ Bk Letter Emphasis	Disabled	No	Yes
+ Specified Pages per File	Disabled	No	Yes
- OCR Setting*		No	Yes
+ Font	Western Languages: Arial	No	Yes
	Japanese: MS Gothic	No	Yes
	Chinese: SimSun	No	Yes
	Traditional Chinese: MingLiU	No	Yes
	Korean: Dotum	No	Yes
+ Detect Image Direction	Enabled	No	Yes
+ File Name Extraction	Disabled	No	Yes
- E-mail		No	Yes
+ File Type	PDF	No	Yes
+ OCR*	Disabled	No	Yes
+ Black & White	Compression Mode: MMR (G4)	No	Yes
+ Colour/Greyscale	Compression Ratio: Medium	No	Yes
+ Bk Letter Emphasis	Disabled	No	Yes
+ Specified Pages per File	Disabled	No	Yes
- OCR Setting*		No	Yes
+ Font	Western Languages: Arial	No	Yes
	Japanese: MS Gothic	No	Yes
	Chinese: SimSun	No	Yes
	Traditional Chinese: MingLiU	No	Yes
	Korean: Dotum	No	Yes
+ Detect Image Direction	Enabled	No	Yes
+ File Name Extraction	Disabled	No	Yes
• Easy Scan Settings		No	Yes
- Colour	Auto	No	Yes
- B/W	Mono2	No	Yes
• Resolution Setting		No	Yes
- Scan		No	Yes
+ Apply the Resolution Set when Stored	Disabled	No	Yes
+ (No item)	200x200dpi	No	Yes



Setup Items	Factory default setting	U	A
- E-mail		No	Yes
+ Apply the Resolution Set when Stored	Disabled	No	Yes
+ (No item)	200x200dpi	No	Yes
◆ Condition Settings		No	Yes
• Default Reply.Address Set	–	No	Yes
• PDF Compression Options		No	Yes
- Flate Compression	Enabled	No	Yes
• Compression Mode at Broadcasting		No	Yes
- Black & White	MH (G3)	No	Yes
- Colour/Greyscale	Medium	No	Yes
+ Bk Letter Emphasis	Disabled	No	Yes
• Send Destination Link Settings	Enabled	No	Yes
- Enable Send Destination Link as Default	Disabled	No	Yes
- File Retention Period	4 Hour	No	Yes
- Enable SSL	Enabled	No	Yes
• Maximum Size of E-mail Attachments(E-Mail)	Unlimited	No	Yes
- If the E-mail attachment(s) exceed maximum size, it will be sent in multiple files.	Disabled	No	Yes
• Maximum Size of Data Attachments(FTP/Desktop/Network Folder)	Unlimited	No	Yes
• Bcc Setting		No	Yes
- Enable Bcc	Disabled	No	Yes
- Display Bcc Address on the Job Status Screen	Disabled	No	Yes
• Auto Scan Setting*	Disabled	No	Yes
- Set Image Orientation Automatically	Enabled, 2-Sided	No	Yes
- Set Resolution Automatically	Enabled	No	Yes
- Blank Page Skip	Enabled, Skip Blank Page	No	Yes
• Disable Scan Function		No	Yes
- PC Scan	Disabled	No	Yes
• Preset restriction of E-mail for direct input	–	No	Yes
◆ Default Address	Disabled	No	Yes
• Add Selected	Select From Address Book	No	Yes
- Index	All Destinations	No	Yes
- Display Items	10	No	Yes
- Allow cancel of the first entered address	Disabled	No	Yes
- Disable selection of other address(es)	Disabled	No	Yes
◆ Administration Settings		No	Yes
• Advanced Settings		No	Yes



Setup Items	Factory default setting	U	A
- Disable Selection of Reply-to.	Disabled	No	Yes
• File Naming		No	Yes
- Unit Serial Number	Disabled	No	Yes
- Text	Disabled	No	Yes
- Sender Name	Enabled	No	Yes
- Date & Time	Enabled	No	Yes
- Session Page Counter	Disabled	No	Yes
- Unique Identifier	Disabled	No	Yes
• Default Subject	–	No	Yes
• Add Job Information Automatically to the Mail Message Body	Enabled	No	Yes
• Add a Footer Automatically to the Mail Message Body	Disabled	No	Yes
• Mail Footer Registration	–	No	Yes
◆ Subject Name Settings	–	Yes	Yes
◆ File Name Settings	–	Yes	Yes
◆ Message Body Settings	–	Yes	Yes

* Can only be enabled on the MX-3060V/MX-3070V/MX-3560V/MX-3570V/MX-4060V/MX-4070V/MX-5070V/MX-6070V.



For fax settings, refer to "[SETTING MODE FOR FAX \(page 7-178\)](#)".

Internet Fax Settings

Setup Items	Factory default setting	U	A
● Internet Fax Settings (page 7-102) * ¹			
▶ Default Settings		No	Yes
◆ Resolution Setting		No	Yes
• Apply the Resolution Set when Stored	Disabled	No	Yes
• (No item)	200x100dpi	No	Yes
• Half Tone	Disabled	No	Yes
◆ Auto Wake Up Print	Enabled	No	Yes
◆ Initial File Format Setting		No	Yes
• File Type	TIFF-F	No	Yes
• Compression Mode	MH (G3)	No	Yes
◆ Speaker Volume Setting		No	Yes
• Receive Signal	Middle	No	Yes
• Communication Error Signal	Middle	No	Yes
• Original Print on Transaction Report	Print Out Error Report Only	No	Yes
◆ Transaction Report Print Select Setting		No	Yes



Setup Items	Factory default setting	U	A
• Single Sending	Print Out Error Report Only	No	Yes
• Broadcasting	Print Out All Report	No	Yes
• Receiving	No Printed Report	No	Yes
◆ Activity Report Print Select Setting		No	Yes
• Auto Print at Memory Full	Disabled	No	Yes
• Print Daily at Designated Time	Disabled	No	Yes
• Body Text Print Select Setting	Disabled	No	Yes
► Send Setting		No	Yes
◆ I-Fax Reception Report On/Off Setting	Disabled	No	Yes
◆ I-Fax Reception Report Request Timeout Setting	1 Hour	No	Yes
◆ Number of Resend Times at Reception Error	2 Time(s)	No	Yes
◆ Maximum Size of E-mail Attachments	Unlimited	No	Yes
◆ Rotation Sending Setting	All Enabled	No	Yes
◆ Default Own Number Sending	Enabled	No	Yes
◆ Printing Page Number at Receiver	Enabled	No	Yes
◆ Recall in Case of Line Busy		No	Yes
• Number of Times to Recall When Line is Busy	2 Time(s)	No	Yes
• Interval to Wait Between Recall Attempts (min.) When Line is Busy	3 Time(s)	No	Yes
◆ Recall in Case of Communication Error		No	Yes
• Number of Times to Recall in Case of Error	2 Time(s)	No	Yes
• Interval to Wait Between Recall Attempts (min.) in Case of Error	3 Time(s)	No	Yes
► Receive Settings		No	Yes
◆ Auto Receive Reduce Setting	Enabled	No	Yes
◆ 2-Sided Printing of Received Data	Disabled	No	Yes
◆ Set Address for Data Forwarding		No	Yes
• Forwarding to	–	No	Yes
• Direct SMTP	Disabled	No	Yes
• Add Hostname or IP Address.	Disabled	No	Yes
• Hostname or IP Address	–	No	Yes
◆ Receiving Date & Time Print	Disabled	No	Yes
◆ Letter Size RX Reduce Print*2	Disabled	No	Yes
◆ POP3 Communication Timeout	60sec.	No	Yes
◆ A3 RX Reduce*2	Disabled	No	Yes
◆ Reception Check Interval Setting	5 Minute	No	Yes
• Fax Output Settings	Varies depending on the machine configuration	No	Yes
◆ Allow/Reject Mail or Domain Name Setting		No	Yes



Setup Items	Factory default setting	U	A
• Allow/Reject Mail or Domain Name Setting	All Invalid	No	Yes
• Add New	–	No	Yes
► Server Settings		No	Yes
◆ Receive Settings		No	Yes
• Internet Fax Receive	Enabled	No	Yes
• POP3 Server	–	No	Yes
• Port Number	110	No	Yes
• POP Authentication	Disabled	No	Yes
• User Name	–	No	Yes
• Password	–	No	Yes
- Change Password	Disabled	No	Yes
• POP3 Communication Timeout	60sec.	No	Yes
• Reception Check Interval Setting	5 minutes	No	Yes
• Enable SSL	Disable	No	Yes
◆ Default Settings		No	Yes
• I-Fax Own Name and Address Set		No	Yes
- Set I-Fax Own Name	–	No	Yes
- Own Address	–	No	Yes
• Direct SMTP Setting		No	Yes
- Port Number (Receive)	25	No	Yes
- Timeout	300 seconds	No	Yes
- Port Number (Send)	25	No	Yes
- Timeout	300 seconds	No	Yes

*1 When an internet fax expansion kit is installed.

*2 This function is not available in some countries and regions.

Fax Data Receive/Forward (Manual)

Setup Items	Factory default setting	U	A
● Fax Data Receive/Forward (Manual) (page 7-108)			
► Fax Settings*1	See " Fax Data Receive/Forward (Manual) (page 7-191) ".	Yes	Yes
► Internet Fax Settings*2		Yes	Yes
◆ Reception Start	–	Yes	Yes
◆ Manual Reception Key in Initial Screen	Enabled	Yes	Yes
◆ Forward Received Data	–	Yes	Yes

*1 When a facsimile expansion kit is installed.

*2 When an internet fax expansion kit is installed.



Inbound Routing (Forwarding/Storing) Settings

Setup Items	Factory default setting	U	A
● Inbound Routing (Forwarding/Storing) Settings (page 7-109)*			
▶ Inbound Routing Settings	–	Yes	Yes
◆ Table Registration	–	Yes	Yes
◆ Sender Settings for Received Data		Yes	Yes
• Receive Line Select		Yes	Yes
- Internet Fax	Enabled	Yes	Yes
- Fax	Enabled	Yes	Yes
• Sender Address Setting	Forward All Received Data	Yes	Yes
◆ Forwarding Destination Settings for Received Data		Yes	Yes
• Forward Condition 1 to 3		Yes	Yes
- Forward Condition	No Forwarding	Yes	Yes
- Day of the Week	All Invalid	Yes	Yes
- Set Forwarding Time	Disabled	Yes	Yes
- Start Time	00 Hour 00 Minute	Yes	Yes
- Completing Time	00 Hour 00 Minute	Yes	Yes
- Format for Forwarding	TIFF(Multi)	Yes	Yes
▶ Sender Address Registration	–	Yes	Yes
▶ Administration Settings		No	Yes
◆ Inbound Routing Settings		No	Yes
• Inbound Routing	Disabled	No	Yes
• Disable Registration of Forward Table	Disabled	No	Yes
• Disable Change/Delete of Forward Table	Disabled	No	Yes
• Disabling of Forward Condition Change	Disabled	No	Yes
• Print Style Setting	Print at Error	No	Yes
◆ File Name Setting		No	Yes
• Preset of Character		No	Yes
- Character 1, 2	–	No	Yes
- File Naming		No	Yes
+ No.1	Sender Name	No	Yes
+ No.2	Date & Time	No	Yes
+ No.3	None	No	Yes
+ No.4	None	No	Yes
+ No.5	None	No	Yes
+ No.6	None	No	Yes
+ No.7	None	No	Yes
+ If received from a contact registered in the address book, sender's name is changed to contact's name.	Disabled	No	Yes



Setup Items	Factory default setting	U	A
► Inbound Routing (Storage) Settings		No	Yes
◆ Settings for HDD Storing of Received Data		No	Yes
• Auto Storing of Received Data in HDD	Disabled	No	Yes
• Specifying Data to be Stored		No	Yes
- Fax	Disabled	No	Yes
- Internet Fax	Disabled	No	Yes
• Specifying Stored Folder	–	No	Yes
- Sort Received Faxes by Date in Folders	Disabled	No	Yes
• File Format	PDF	No	Yes
• Print Style Setting	Print Only at Storage Error	No	Yes
◆ File Name Setting		No	Yes
• Preset of Character		No	Yes
- Character 1, 2	–	No	Yes
- File Naming		No	Yes
+ No.1	Sender Name	No	Yes
+ No.2	Date & Time	No	Yes
+ No.3	None	No	Yes
+ No.4	None	No	Yes
+ No.5	None	No	Yes
+ No.6	None	No	Yes
+ No.7	None	No	Yes
+ If received from a contact registered in the address book, sender's name is changed to contact's name.	Disabled	No	Yes
◆ Setting of Result Notification Address at Storing		No	Yes
• Reception Notification Settings	Disabled	No	Yes
• Address of Notification Destination	–	No	Yes
• Direct Entry	–	No	Yes

* When a facsimile expansion kit or internet fax expansion kit is installed.

Metadata Settings

Setup Items	Factory default setting	U	A
● Metadata Settings (page 7-112)			
► Metadata Settings		No	Yes
◆ Metadata Settings	Disabled	No	Yes
► Metadata Set List	–	No	Yes



Document Filing Settings

U: General user; A: System administrator/Administrator

Setup Items	Factory default setting	U	A
● Document Filing Settings (page 7-113)			
▶ Condition Settings		No	Yes
◆ Default Mode Settings	Sharing Mode	No	Yes
◆ Sort Method Setting	Date	No	Yes
◆ Administrator Authority Setting		No	Yes
• Delete File	Disabled	No	Yes
• Delete Folder	Disabled	No	Yes
• Change PIN Code/Password	Disabled	No	Yes
◆ Delete All Quick Files		No	Yes
• Delete	–	No	Yes
• Delete quick files at power up.(Protected files excluded)	Enabled	No	Yes
◆ Image Orientation	Portrait	No	Yes
◆ Default Colour Mode Settings	Auto, Mono2	No	Yes
◆ Disable Change of B/W Setting in Auto Mode	Disabled	No	Yes
◆ Default Exposure Settings	Auto	No	Yes
◆ Default Original Image Type	Text	No	Yes
◆ Initial Resolution Settings	200x200dpi	No	Yes
◆ Scan Complete Sound Setting	Middle	No	Yes
◆ Default Output Tray	Varies depending on the machine configuration	No	Yes
◆ Disable Text/Stamp functions for Reprinting	Disabled	No	Yes
◆ Batch Print Settings		No	Yes
• Selection of [All Users] is not allowed.	Enabled	No	Yes
• Selection of [User Unknown] is not allowed.	Enabled	No	Yes
• Print Order	Date (Dsc.)	No	Yes
◆ Erase Width Adjustment		No	Yes
• Edge Clearance Width	10mm (1/2")	No	Yes
• Centre Clearance Width	10mm (1/2")	No	Yes
◆ Card Shot Settings		No	Yes
• Original Size	X: 86 mm (3-3/8"), Y: 54 mm (2-1/8")	No	Yes
• Fit to Store Size	Disabled	No	Yes
◆ Setting of store/delete after file print	Store	No	Yes



Setup Items	Factory default setting	U	A
► Default Setting of PDF Format for PC Browsing		No	Yes
◆ B/W		No	Yes
• Compression Mode	MMR (G4)	No	Yes
◆ Colour/Greyscale		No	Yes
• Compression Ratio	Medium	No	Yes
◆ Copies	Disabled	No	Yes
• Apply the resolution at job execution	Disabled	No	Yes
• Resolution	200×200dpi	No	Yes
◆ Printer	Disabled	No	Yes
• Apply the resolution at job execution	Disabled	No	Yes
• Resolution	200×200dpi	No	Yes
◆ Scan to	Disabled	No	Yes
• Apply the resolution at job execution	Disabled	No	Yes
• Resolution	200×200dpi	No	Yes
◆ Internet Fax* ¹	Disabled	No	Yes
• Apply the resolution at job execution	Disabled	No	Yes
• Resolution	200×100dpi	No	Yes
◆ Fax* ²	Disabled	No	Yes
• Apply the resolution at job execution	Disabled	No	Yes
• Resolution	Standard	No	Yes
◆ Scan to HDD	Enabled	No	Yes
• Apply the resolution at job execution	Disabled	No	Yes
• Resolution	200×200dpi	No	Yes
► Document Output Options		No	Yes
◆ Print		No	Yes
• Copies	Enabled	No	Yes
• Printer	Enabled	No	Yes
• Scan Send	Disabled	No	Yes
• Internet Fax Send(Incl. PC-I-Fax)* ¹	Disabled	No	Yes
• Fax Send(Incl. PC-Fax)* ²	Disabled	No	Yes
• Scan to HDD	Enabled	No	Yes
◆ Scan Send		No	Yes
• Copies	Disabled	No	Yes
• Printer	Disabled	No	Yes
• Scan Send	Enabled	No	Yes
• Internet Fax Send(Incl. PC-I-Fax)	Disabled	No	Yes



Setup Items	Factory default setting	U	A
• Fax Send(Incl. PC-Fax)	Disabled	No	Yes
• Scan to HDD	Enabled	No	Yes
◆ Internet Fax Send* ¹		No	Yes
• Internet Fax Send(Incl. PC-I-Fax)	Enabled	No	Yes
◆ Fax Send* ²		No	Yes
• Copies	Disabled	No	Yes
• Printer	Disabled	No	Yes
• Scan Send	Disabled	No	Yes
• Internet Fax Send(Incl. PC-I-Fax)* ¹	Disabled	No	Yes
• Fax Send(Incl. PC-Fax)	Enabled	No	Yes
• Scan to HDD	Disabled	No	Yes
▶ Document Filing Control	–	No	Yes
▶ Automatic Deletion of File Settings	All Invalid	No	Yes

*1 When an internet fax expansion kit is installed.

*2 When a facsimile expansion kit is installed.



Sharp OSA Settings

U: General user; A: System administrator/Administrator

Setup Items	Factory default setting	U	A
● Sharp OSA Settings (page 7-116)			
▶ Condition Settings*1		No	Yes
◆ Cookie Setting	–	No	Yes
◆ Delete Cookie	–	No	Yes
▶ Standard Application Settings	–	No	Yes
▶ Receiving Application Setting		No	Yes
◆ Forward to Application	Disabled	No	Yes
◆ Application Name	–	No	Yes
◆ Address for Web Service	–	No	Yes
◆ Timeout	20 seconds	No	Yes
◆ Communication Error Notification		No	Yes
• E-mail Address	–	No	Yes
• Body Text	–	No	Yes
• Connection Test	–	No	Yes
▶ External Accounting Application Settings		No	Yes
◆ External Account Control	Disabled	No	Yes
◆ Set Authentication Server (Server 1)		No	Yes
• Server 1-4	Disabled	No	Yes
- Application Name	–	No	Yes
- Address for Application UI*2	–	No	Yes
- Address for Web Service	–	No	Yes
- Timeout	20 seconds	No	Yes
- Browser*2	HTML Browser n2.0	No	Yes
- Extended Platform	Disabled	No	Yes
- Data Size*2	Wide-SVGA	No	Yes
- Find My Address*2	–	No	Yes
- Target*2	LDAP	No	Yes
◆ Communication Error Notification		No	Yes
• E-mail Address	–	No	Yes
• Body Text	–	No	Yes
▶ Embedded Application Settings	–	No	Yes
▶ Polling Setting		No	Yes
◆ Server 1 - Server 2	Disabled	No	Yes
• Polling Address	–	No	Yes
• Check Interval	1min.	No	Yes



Setup Items	Factory default setting	U	A
• Timeout	20 seconds	No	Yes

*1 This setting is configured in setting mode on the machine.

*2 This setting can be set in Server 1.

Common Settings

U: General user; A: System administrator/Administrator

Setup Items	Factory default setting	U	A
● Common Settings (page 7-119)			
▶ Paper Settings		Yes	Yes
◆ Paper Tray Settings		Yes	Yes
• Auto Switching of Tray	Enabled	Yes	Yes
• Display Paper Tray Settings when bypass tray detects paper.	Enabled	Yes	Yes
• Tray 1	When using the MX-5050V/ MX-5070V/MX-6050V/MX-6070V Plain, Auto-AB (Auto-Inch) When using the MX-2630N/ MX-3050V/MX-3060V/MX-3070V/ MX-3550V/MX-3560V/MX-3570V/ MX-4050V/MX-4060V/MX-4070V Plain, A4 (8-1/2" x 11")	Yes	Yes
• Tray 2 ^{*1}	Plain, Auto-AB (Auto-Inch) Stand/550&2100 sheet paper drawer Tray 3 Plain, A4 (8-1/2" x 11") Tray 4 Plain, A4 (8-1/2" x 11")	Yes	Yes
• Tray 3 ^{*2}		Yes	Yes
• Tray 4 ^{*3}		Yes	Yes
• Tray 5 ^{*4}	Plain, A4 (8-1/2" x 11")	Yes	Yes
• Bypass Tray	Plain, Auto-AB (Auto-Inch)	Yes	Yes
◆ Custom Size Registration (Bypass)	Custom 1 to 7 Auto-AB (Auto-Inch) X=420mm (17") Y=297mm (11")	Yes	Yes
◆ Paper Type Registration	–	Yes	Yes
▶ Operation Settings		No	Yes
◆ Condition Settings		No	Yes
• Enlarge Display Mode	Disabled	No	Yes
• Message Time Setting	6 sec.	No	Yes
• Language Setting	Varies depending on country and region	No	Yes
• Default Display Setting	Home Screen	No	Yes
• Display Favorite Menus as Default	Disabled	No	Yes
• Display Action Panel as default.	Enabled	No	Yes
• Icon is displayed when network cable is not connected.	Enabled	No	Yes



Setup Items	Factory default setting	U	A
• Display Confirmation Dialog when job is cancelled.	Enabled	No	Yes
• Switch the Number of Sets to be Displayed for Job Status	Progress	No	Yes
• Alignment Order of 10-Key	Ascending order from upper left	No	Yes
• Setting Display from Main Unit		No	Yes
- Display Current Path	Enabled	No	Yes
- Enable link of current path	Enabled	No	Yes
• MFP Display Pattern Setting	Pattern 1	No	Yes
• Key Operation Setting		No	Yes
- Keys Touch Sound	Middle	No	Yes
- Make Key Touch Sound at Default Setting	Disabled	No	Yes
- Auto Clear Setting	60sec.	No	Yes
+ Cancel Timer	Disabled	No	Yes
- Key Operation Setting : Time for Accepting Key Entry	0.0 seconds	No	Yes
+ Disable Auto Key Repeat	Disabled	No	Yes
- Time for Accepting Key Entry of Long Touch	0.5 seconds	No	Yes
- Double Tap Interval Setting	0.5 seconds	No	Yes
• Disabling of Job Priority Operation	Disabled	No	Yes
• Disabling of Bypass Printing	Disabled	No	Yes
• Disabling of Covers/Inserts Mode	Disabled	No	Yes
• Disable Printing of Operation Manual from the Operation Panel	Disabled	No	Yes
• Initial Original Count Setting	All Invalid	No	Yes
• Preview Setting		No	Yes
- Received Data Image Check Setting	Disabled	No	Yes
- Default List/Thumbnail Display		No	Yes
+ Fax/I-Fax Reception Data *5, *6	Thumbnail	No	Yes
+ File Retrieve of Main Folder/Quick File Folder	List	No	Yes
+ File Retrieve of Custom Folder	List	No	Yes
+ File Retrieve of Direct Print	List	No	Yes
• Remote Operation Settings		No	Yes
- Remote Software Operation		No	Yes
+ Operational Authority	Prohibited	No	Yes
+ View Password Entry Screen	Display in Both PC and MFP	No	Yes
- Operation from Specified PC		No	Yes
+ Operational Authority	Prohibited	No	Yes



Setup Items	Factory default setting	U	A
+ Hostname or IP Address of PC	–	No	Yes
+ View Password Entry Screen	Display in Both PC and MFP	No	Yes
- Operation by User who Has Password		No	Yes
+ Operational Authority	Prohibited	No	Yes
+ View Password Entry Screen	Display in Both PC and MFP	No	Yes
◆ Easy Mode Settings	–	No	Yes
◆ Favorite Key Setting	–	No	Yes
◆ Mode Key Display Setting		No	Yes
• Modes to Display	–	No	Yes
• Display Mode Keys on Home	Enabled	No	Yes
► Keyboard Settings		No	Yes
◆ Default Keyboard Setting		No	Yes
• Keyboard Select	Varies depending on country and region	No	Yes
• Set Keyboard Priority	Varies depending on country and region	No	Yes
◆ Soft Keyboard Template Setting	–	No	Yes
► Device Control		No	Yes
◆ Original Size Detector Setting		No	Yes
• Original Detection Size Combination	AB-1 (Inch-1)	No	Yes
• Cancel Detection at Document Glass	Disabled	No	Yes
◆ Original Feeding Mode	All Off	No	Yes
◆ Automatic Saddle Stitch*7	Enabled	No	Yes
◆ Saddle Stitch Position Adjust*7	Enabled	No	Yes
◆ Paper Type for Auto Paper Selection	Plain	No	Yes
◆ Tandem Connection Setting		No	Yes
• IP Address of Client Machine	0.0.0.0	No	Yes
• Port Number	50001	No	Yes
• Tandem Mode		No	Yes
- Disabling of Master Machine Mode	Disabled	No	Yes
- Disabling of Client Machine Mode	Disabled	No	Yes
◆ Auto Switching of Finisher Trays*8	Enabled	No	Yes
◆ Detect Standard in Auto Colour Mode	3 (Normal)	No	Yes
◆ Data Indicator Setting	Pattern 1	No	Yes
• Status Indicator will blink if data is received	Enabled	No	Yes
• Error Light Setting	Light & Blink	No	Yes



Setup Items	Factory default setting	U	A
◆ Total Setting for Finish	Specify Finishing Position Based on Paper Selected.	No	Yes
◆ Plain Paper Weight Settings		No	Yes
• Paper Weight	60 to 89g/m ² (16 to 23 lbs.)	No	Yes
◆ Data List	One Sided	No	Yes
◆ Disabling of Duplex	Disabled	No	Yes
◆ Disabling of Offset	Disabled	No	Yes
◆ Disabling of Document Feeder	Disabled	No	Yes
◆ Disabling of Large Capacity Cassette* ⁴	Enabled	No	Yes
◆ Disabling of Optional Paper Drawer* ¹	Disabled	No	Yes
◆ Disabling of Tray Settings	Disabled	No	Yes
◆ Disabling of Finisher* ⁷	Disabled	No	Yes
◆ Disabling of Stapler* ⁷	Disabled	No	Yes
◆ Disabling of Punch* ⁹	Disabled	No	Yes
► Enable/Disable Settings		No	Yes
◆ User Control		No	Yes
• Disabling of Printing by Invalid User	Disabled	No	Yes
◆ Copy Function Settings		No	Yes
• Disabling of Registration/Deletion of Program	Disabled	No	Yes
• Disabling of Bypass-Tray in Duplex Copy	Disabled	No	Yes
• Disabling of Auto Paper Selection	Disabled	No	Yes
• Disabling Registration of Custom Image	Disabled	No	Yes
• Disabling sending while copying	Disabled	No	Yes
◆ Printer Settings		No	Yes
• Prohibit Notice Page Printing	Enabled	No	Yes
• Prohibit Test Page Printing	Disabled	No	Yes
• Exclude Bypass-Tray from Auto Paper Select	Disabled	No	Yes
• Disabling of USB Memory Direct Print	Disabled	No	Yes
• Disabling of Network Folder Direct Print	Disabled	No	Yes
• Disabling sending while printing	Disabled	No	Yes
• Disable Blank Page Print	Disabled	No	Yes
◆ Image Send Settings		No	Yes
• Disable Switching of Display Order	Disabled	No	Yes
• Disable Fax Broadcasting* ⁵	Disabled	No	Yes
• Disable Scan Function	All Invalid	No	Yes
• Settings to Disable Registration		No	Yes



Setup Items	Factory default setting	U	A
- Disable Registering Destination from Operation Panel	All Invalid	No	Yes
- Disable Registering Destination on Web Page	All Invalid	No	Yes
- Disabling of Registration/Deletion of Program	Disabled	No	Yes
- Disable Registration of Memory Box*5	All Invalid	No	Yes
- Disable Destination Registration Using Global Address Search	All Invalid	No	Yes
- Disable Registration Using Network Scanner Tool	Disabled	No	Yes
- Disabling of Forwarding via Network	Disabled	No	Yes
• Settings to Disable Transmission		No	Yes
- Disable [Resend] on Fax/Image Send Mode*5, *6	Disabled	No	Yes
- Disable Selection from Address Book	All Invalid	No	Yes
- Disable Direct Entry	All Invalid	No	Yes
- Disable PC-I-Fax Transmission*6	Disabled	No	Yes
- Disable PC-Fax Transmission*5	Disabled	No	Yes
- Disabling of Find My Address	Disabled	No	Yes
◆ Document Filing Settings		No	Yes
• Disable Text/Stamp functions for Reprinting	Disabled	No	Yes
• Batch Print Settings		No	Yes
- Selection of [All Users] is not allowed.	Enabled	No	Yes
- Selection of [User Unknown] is not allowed.	Enabled	No	Yes
◆ Operation Settings		No	Yes
• Cancel Auto Clear Timer	Disabled	No	Yes
• Disabling of Job Priority Operation	Disabled	No	Yes
• Disabling of Bypass Printing	Disabled	No	Yes
• Disable Auto Key Repeat	Disabled	No	Yes
• Disabling of Clock Adjustment	Disabled	No	Yes
• Disabling of Covers/Inserts Mode	Disabled	No	Yes
• Disable Printing of Operation Manual from the Operation Panel	Disabled	No	Yes
◆ Device Control		No	Yes
• Disabling of Document Feeder	Disabled	No	Yes
• Disabling of Duplex	Disabled	No	Yes
• Disabling of Large Capacity Cassette*4	Enabled	No	Yes
• Disabling of Optional Paper Drawer*1	Disabled	No	Yes
• Disabling of Tray Settings	Disabled	No	Yes
• Disabling of Finisher*7	Disabled	No	Yes



Setup Items	Factory default setting	U	A
• Disabling of Offset	Disabled	No	Yes
• Disabling of Stapler*7	Disabled	No	Yes
• Disabling of Punch*9	Disabled	No	Yes
• Disabling of Master Machine Mode	Disabled	No	Yes
• Disabling of Client Machine Mode	Disabled	No	Yes
◆ Security Settings		No	Yes
• Hidden Pattern Print Setting		No	Yes
- Disable Direct Entry	Disabled	No	Yes
▶ Machine Identification Settings	–	No	Yes
▶ Clock Adjust		No	Yes
◆ Clock Adjust		No	Yes
• Current Date	–	No	Yes
• Specify Time Zone	–	No	Yes
• Date&Time Settings	–	No	Yes
• Synchronize with Internet Time Server	Disabled	No	Yes
◆ Daylight Saving Time Setting	Disabled	No	Yes
◆ Date Format		No	Yes
• Current Setting	–	No	Yes
• Format	Varies depending on country and region	No	Yes
▶ Product Key		No	Yes
◆ Serial Number	–	No	Yes
◆ Font Kit for Barcode	–	No	Yes
◆ Internet Fax Expansion Kit*6	–	No	Yes
◆ Application Integration Module	–	No	Yes
◆ Direct Print Expansion Kit*10	–	No	Yes
◆ Application Communication Module*10, *11	–	No	Yes
◆ External Account Module*10, *11	–	No	Yes
▶ Custom Links	–	No	Yes

*1 When a stand/550 sheet paper drawer/low stand/550 sheet paper drawer/stand/2x550 sheet paper drawer/stand/3x550 sheet paper drawer/stand/550&2100 sheet paper drawer is installed.

*2 When a stand/2x550 sheet paper drawer/stand/3x550 sheet paper drawer/stand/550&2100 sheet paper drawer is installed.

*3 When a stand/3x550 sheet paper drawer/stand/550&2100 sheet paper drawer is installed.

*4 When a large capacity tray is installed.

*5 When a facsimile expansion kit is installed.

*6 When an internet fax expansion kit is installed.

*7 When a saddle stitch finisher/saddle stitch finisher (large stacker) is installed.

*8 When a finisher (large stacker)/saddle stitch finisher (large stacker) is installed.

*9 When an inner finisher/finisher/finisher (large stacker)/saddle stitch finisher/saddle stitch finisher (large stacker) is installed and a punch module is installed.

*10 Can only be enabled on the MX-2630N/MX-3050V/MX-3550V/MX-4050V/MX-5050V/MX-6050V.

*11 This setting cannot be specified in some countries and regions.



Network Settings

U: General user; A: System administrator/Administrator

Setup Items	Factory default setting	U	A
● Network Settings (page 7-137)			
▶ Quick Settings		No	Yes
◆ Wireless Settings		No	Yes
• Connection Type	Wired Only	No	Yes
◆ IPv4 Settings		No	Yes
• DHCP	Enabled	No	Yes
• IPv4 Address	–	No	Yes
• Subnet Mask	–	No	Yes
• Default Gateway	–	No	Yes
◆ Network Name Settings		No	Yes
• Device Name	–	No	Yes
• Domain Name	–	No	Yes
◆ DNS Settings		No	Yes
• Primary Server	–	No	Yes
• Secondary Server	–	No	Yes
• Domain Name	–	No	Yes
◆ SMTP Settings		No	Yes
• Primary Server	–	No	Yes
• Sender Name	–	No	Yes
• Sender Address	–	No	Yes
• Enable SSL	–	No	Yes
• SMTP Authentication	–	No	Yes
• User Name	–	No	Yes
• Password	–	No	Yes
- Change Password	–	No	Yes
• Connection Test	–	No	Yes
◆ LDAP Settings		No	Yes
• Name	–	No	Yes
• Search Root	–	No	Yes
• LDAP Server	–	No	Yes
• User Name	–	No	Yes
• Password	–	No	Yes
- Change Password	–	No	Yes
• Authentication Type	–	No	Yes
• KDC Server	–	No	Yes
• Realm	–	No	Yes
• Allow selection on operation panel.	Disabled	No	Yes



Setup Items	Factory default setting	U	A
• Authenticate a User in Global Address Search	Disabled	No	Yes
• Enable SSL	–	No	Yes
• Connection Test	–	No	Yes
◆ Public Folder / NAS Setting		No	Yes
• public		No	Yes
- Use of Storage	Allowed	No	Yes
• shared		No	Yes
- Use of Storage	Allowed	No	Yes
• faxreceive		No	Yes
- Use of Storage	Allowed	No	Yes
► Network Name Setting		No	Yes
◆ Device Name	–	No	Yes
◆ Domain Name	–	No	Yes
◆ Comment	–	No	Yes
► Protocol Settings		No	Yes
◆ IPv4 Settings		No	Yes
• DHCP	Enabled	No	Yes
• IPv4 Address	–	No	Yes
• Subnet Mask	–	No	Yes
• Default Gateway	–	No	Yes
◆ IPv6 Settings		No	Yes
• IPv6	Enabled	No	Yes
• DHCPv6	Enabled	No	Yes
• Manual Address / Prefix Length	–	No	Yes
• Default Gateway	–	No	Yes
◆ MTU Settings		No	Yes
• MTU	1500	No	Yes
◆ SMB Settings		No	Yes
• Use SMB1.0	Enabled	No	Yes
• Use SMB2.0	Enabled	No	Yes
• Use SMB2.1	Enabled	No	Yes
• Use SMB3.0	Enabled	No	Yes
◆ Ping Command		No	Yes
• IPv4	–	No	Yes
• IPv6	–	No	Yes
► Services Settings		No	Yes
◆ DNS	–	No	Yes
• DNS Settings	–	No	Yes
- IPv4 Settings	–	No	Yes



Setup Items	Factory default setting	U	A
- Primary Server	–	No	Yes
- Secondary Server	–	No	Yes
- IPv6 Settings	–	No	Yes
- Primary Server	–	No	Yes
- Secondary Server	–	No	Yes
- Timeout	2 seconds	No	Yes
- Domain Name	–	No	Yes
- DNS Update	Disabled	No	Yes
- Update Interval	3 minutes	No	Yes
◆ SMTP	–	No	Yes
• SMTP Settings	–	No	Yes
- Primary Server	–	No	Yes
- Secondary Server	–	No	Yes
- Port Number	25	No	Yes
- Timeout	20 seconds	No	Yes
- Sender Name	–	No	Yes
- Sender Address	–	No	Yes
- Enable SSL	Disabled	No	Yes
- SMTP Authentication	Disabled	No	Yes
- User Name	–	No	Yes
- Password	–	No	Yes
- POP before SMTP	Disabled	No	Yes
- Connection Test	–	No	Yes
◆ Kerberos	–	No	Yes
• Kerberos Authentication Settings	–	No	Yes
- KDC Server	–	No	Yes
- Port Number	88	No	Yes
- Realm	–	No	Yes
◆ SNTP	–	No	Yes
• SNTP Settings	–	No	Yes
- SNTP	–	No	Yes
- SNTP Server	–	No	Yes
- Port Number	123	No	Yes
- Timeout	5 seconds	No	Yes
- Synchronous Interval	6 hours	No	Yes
- Synchronize Upon Start	Disabled	No	Yes
- Synchronize Now	–	No	Yes
◆ mDNS	–	No	Yes
• mDNS Settings	–	No	Yes



Setup Items	Factory default setting	U	A
- mDNS	Enabled	No	Yes
- Service Name	Model Name (Serial Number)	No	Yes
- Domain Name	Model Name-Serial Number-.Local	No	Yes
- Highest Priority Service	LPD	No	Yes
◆ SNMP	–	No	Yes
• SNMP v1 Settings	–	No	Yes
- SNMP v1 Settings	Enabled	No	Yes
- Access Method	–	No	Yes
- GET Community	public	No	Yes
- SET Community	private	No	Yes
- Change SET Community	Disabled	No	Yes
- TRAP Community	public	No	Yes
- TRAP Target Address	–	No	Yes
• SNMP v3 Settings	–	No	Yes
- SNMP v3 Settings	–	No	Yes
- User Name	–	No	Yes
- Authentication Key	–	No	Yes
- Privacy Key	–	No	Yes
- Context Name	–	No	Yes
◆ WINS	–	No	Yes
• WINS Settings	–	No	Yes
- Primary Server	–	No	Yes
- Secondary Server	–	No	Yes
- Scope ID	–	No	Yes
► Print Port Settings		No	Yes
◆ LPD		No	Yes
• LPD Settings		No	Yes
- LPD	Enabled	No	Yes
- Timeout	90 seconds	No	Yes
- Use Banner	Disabled	No	Yes
◆ RAW		No	Yes
• Raw Print Settings		No	Yes
- Raw Print	Enabled	No	Yes
- Port Number	9100	No	Yes
- Timeout	90 seconds	No	Yes
- Use Bidirectional	Disabled	No	Yes
◆ WSD		No	Yes
• WSD Settings		No	Yes
- WSD Print	Enabled	No	Yes



Setup Items	Factory default setting	U	A
- Use Multicast Discovery	Enabled	No	Yes
► External Print Services Settings		No	Yes
◆ Google Cloud Print Settings		No	Yes
• Google Cloud Print	Disabled	No	Yes
• Status	–	No	Yes
- Always Retain Prints	–	No	Yes
• E-mail	–	No	Yes
• Device Name	–	No	Yes
• Register with Google Cloud Print	–	No	Yes
• Delete from Google Cloud Print	–	No	Yes
• Registration URL/QR code	–	No	Yes
◆ AirPrint Settings		No	Yes
• AirPrint (Print)	Enabled	No	Yes
• AirPrint (Scan)	Enabled	No	Yes
• AirPrint (Fax Send)	Enabled	No	Yes
• mDNS	Enabled	No	Yes
• IPP	Enabled	No	Yes
• IPP-SSL	Enabled	No	Yes
• Service Name	–	No	Yes
• Machine Location	–	No	Yes
• geo URI (RFC 5870)	geo:	No	Yes
► External Service Connect		No	Yes
◆ Cloud Connect Settings		No	Yes
• Office 365		No	Yes
- Domain Name	–	No	Yes
• Google Drive		No	Yes
- Google Drive	Enabled	No	Yes
◆ E-mail Connect Settings		No	Yes
• Exchange		No	Yes
- Exchange	Enabled	No	Yes
- Hostname	–	No	Yes
• Gmail		No	Yes
- Gmail	Enabled	No	Yes
► LDAP Settings		No	Yes
◆ LDAP Settings	–	No	Yes
◆ Global Address Books List	–	No	Yes
► Public Folder / NAS Setting		No	Yes
◆ public		No	Yes
• Use of Storage	Allowed	No	Yes



Setup Items	Factory default setting	U	A
◆ shared		No	Yes
• Use of Storage	Allowed	No	Yes
◆ faxreceive		No	Yes
• Use of Storage	Allowed	No	Yes
▶ Proxy Setting		No	Yes
◆ Proxy Setting	Disabled	No	Yes
◆ Proxy Server Address	–	No	Yes
◆ User Name	–	No	Yes
◆ Password	–	No	Yes
• Change Password	–	No	Yes
◆ Port Number	8080	No	Yes
◆ Address without Using Proxy	–	No	Yes
▶ Wireless Settings	–	No	Yes
▶ Easy Connection Setting	-	No	Yes
▶ Device Web Page Setting		No	Yes
◆ HTTP Access Settings		No	Yes
• Number of Users who can Log-in at the Same Time	32	No	Yes
• Auto Logout Time	60 minutes	No	Yes
◆ View Login User	–	No	Yes
▶ Active Directory Settings		No	Yes
◆ Domain Name	–	No	Yes
◆ Search Attribute:	cn	No	Yes
◆ Linkage with User Control Function	–	No	Yes
• Pages Limit Group	pagelimit	No	Yes
• Authority Group	authority	No	Yes
• Favourite Operation Group	favorite	No	Yes
• My Folder	myfolder	No	Yes
◆ Device Registration Account	–	No	Yes
• User Name	–	No	Yes
• Password	–	No	Yes



Security Settings

U: General user; A: System administrator/Administrator

Setup Items	Factory default setting	U	A
● Security Settings (page 7-153)			
▶ Password Change	–	No	Yes
▶ Restrict Device Web Page Access Via Password	Disabled	No	Yes
◆ User Password		No	Yes
• Change Password	Disabled	No	Yes
• Protect Settings by Password	Disabled	No	Yes
◆ Administrator Password		No	Yes
• Change Password	Disabled	No	Yes
▶ Port Control		No	Yes
◆ Server Port		No	Yes
• HTTP	Enabled	No	Yes
- Port Number	80	No	Yes
• HTTPS	Enabled	No	Yes
- Port Number	443	No	Yes
• FTP Print	Enabled	No	Yes
- Port Number	21	No	Yes
• Raw Print	Enabled	No	Yes
- Port Number	9100	No	Yes
• LPD	Enabled	No	Yes
- Port Number	515	No	Yes
• IPP	Enabled	No	Yes
- Port Number	631	No	Yes
• IPP-SSL	Disabled	No	Yes
- Port Number	443	No	Yes
• Tandem Output Receive	Enabled	No	Yes
- Port Number	50001	No	Yes
• PC Scan	Enabled	No	Yes
- Port Number	52000	No	Yes
• Remote Operation Panel	Enabled	No	Yes
- Port Number	5900	No	Yes
• SNMPD	Enabled	No	Yes
- Port Number	161	No	Yes
• NBT/WINS	Disabled	No	Yes
• SMTP	Enabled	No	Yes



Setup Items	Factory default setting	U	A
• WSD	Enabled	No	Yes
• Print Release	Disabled	No	Yes
- Port Number	53000	No	Yes
• Sharp OSA (Expansion Platform)		No	Yes
- HTTPS	Enabled	No	Yes
+ Port Number	10080	No	Yes
- HTTPS	Enabled	No	Yes
+ Port Number	10443	No	Yes
◆ Client Port		No	Yes
• HTTP	Enabled	No	Yes
• HTTPS	Enabled	No	Yes
• FTP	Enabled	No	Yes
• FTPS	Enabled	No	Yes
• SMTP	Enabled	No	Yes
• SMTP-SSL	Enabled	No	Yes
• POP3	Enabled	No	Yes
• POP3-SSL	Enabled	No	Yes
• SNMP-TRAP	Enabled	No	Yes
- Port Number	162	No	Yes
• Notify Job End	Enabled	No	Yes
• LDAP	Enabled	No	Yes
• LDAP-SSL	Enabled	No	Yes
• SMB/WINS	Enabled	No	Yes
• SNTP	Disabled	No	Yes
• mDNS	Enabled	No	Yes
• Tandem Output Send	Enabled	No	Yes
• Data Backup Send	Enabled	No	Yes
• Print Release	Enabled	No	Yes
• XMPP	Disabled	No	Yes
► Filter Setting	Disabled	No	Yes
◆ Filter	Disabled	No	Yes
◆ IP Address Filter Settings		No	Yes
• Filter Mode	Allowed	No	Yes
• Filter Address 1-4		No	Yes
- Start IP Address	0.0.0.0	No	Yes
- End IP Address	0.0.0.0	No	Yes



Setup Items	Factory default setting	U	A
◆ MAC Address Filter Settings		No	Yes
• Filter Address 1-10	000000000000	No	Yes
► SSL Settings		No	Yes
◆ Condition Settings		No	Yes
• Setting of SSL		No	Yes
- Server Port		No	Yes
+ HTTPS	Enabled	No	Yes
+ IPP-SSL	Disabled	No	Yes
+ Redirect HTTP to HTTPS in Device Web Page Access	Disabled	No	Yes
- Client Port		No	Yes
+ HTTPS	Enabled	No	Yes
+ FTPS	Enabled	No	Yes
+ SMTP-SSL	Enabled	No	Yes
+ POP3-SSL	Enabled	No	Yes
+ LDAP-SSL	Enabled	No	Yes
- Level of Encryption	Low	No	Yes
• Device Certificate	–	No	Yes
- Certificate Status	–	No	Yes
- Export Certificate and Private Key	–	No	Yes
• Make of Certificate Signing Request(CSR)	–	No	Yes
► S/MIME Settings		No	Yes
◆ Condition Settings		No	Yes
• S/MIME Settings	Disabled	No	Yes
• Device Certificate		No	Yes
- Certificate Status	–	No	Yes
• Sign Settings		No	Yes
- Sign E-mail	Always Enable	No	Yes
- Signature Algorithm	SHA-1	No	Yes
• Encryption Settings		No	Yes
- Encrypt E-mail	Always Enable	No	Yes
- Encrypt	AES-128	No	Yes
- Disable sending to the addresses which cannot be encrypted.	Disabled	No	Yes
◆ Make of Certificate Signing Request(CSR)	–	No	Yes
► IPsec Settings		No	Yes



Setup Items	Factory default setting	U	A
◆ IPsec Settings	Disabled	No	Yes
◆ IKEv1 Settings		No	No
• Pre-Shared Key	–	No	Yes
• SA Lifetime (time)	28800 seconds	No	Yes
• SA Lifetime (size)	28800KB	No	Yes
• IKE Lifetime	30sec.	No	Yes
◆ IPsec Rules	–	No	Yes
► IEEE802.1X Setting		No	Yes
◆ Condition Settings		No	Yes
• IEEE802.1X Authentication (Wired)	Disabled	No	Yes
• EAP Authentication Method	EAP-TLS	No	Yes
• EAP User Name	–	No	Yes
• Password	–	No	Yes
- Change Password	Disabled	No	Yes
• Server Authentication	Enabled	No	Yes
• EAP Timeout	10 seconds	No	Yes
• Number of EAP Retries	3 times	No	Yes
• Device Certificate		No	Yes
- Certificate Status	–	No	Yes
- CA Certificate Status	–	No	Yes
◆ Make of Certificate Signing Request(CSR)	–	No	Yes
► Security Control		No	Yes
◆ Restrict Print Jobs other than the current Print Hold Job	Disabled	No	Yes
◆ Restrict Operation	Force Retention	No	Yes
◆ Reject Requests from External Sites	Enabled	No	Yes
► Document Administration Function		No	Yes
◆ Forwarding Destination Settings (Send Data)		No	Yes
• Forward Send Data	Disabled	No	Yes
• E-mail	–	No	Yes
• Network Folder	–	No	Yes
• FTP	–	No	Yes
• Desktop	–	No	Yes
• File Format	TIFF(Multi)	No	Yes
◆ Forwarding Destination Settings (Received Data)		No	Yes
• Forward Received Data	Disabled	No	Yes



Setup Items	Factory default setting	U	A
• E-mail	–	No	Yes
• FTP	–	No	Yes
• Desktop	–	No	Yes
• File Format	TIFF(Multi)	No	Yes
► Hidden Pattern Print Setting		No	Yes
◆ Initial Status Settings		No	Yes
• Default Settings		No	Yes
- Hidden Pattern Print Setting	All Invalid	No	Yes
- Print Colour	Black	No	Yes
- Exposure	Standard	No	Yes
- Size	48 points	No	Yes
- Angle	0°	No	Yes
- Font Style	Standard	No	Yes
- Camouflage Pattern	Pattern 1	No	Yes
- Print Method	Positive	No	Yes
• Print Contents Setting		No	Yes
- Pre-Set Word	Enabled, DO NOT COPY	No	Yes
- Unit Serial Number	Disabled	No	Yes
- Account Job ID	Disabled	No	Yes
- Login Name/User Number	Disabled	No	Yes
- Control No.	Disabled	No	Yes
- Date/Time	Disabled	No	Yes
- Disable Direct Entry	Disabled	No	Yes
◆ Contrast		No	Yes
• Hidden Pattern Print		No	Yes
- Black	5	No	Yes
- Magenta	5	No	Yes
- Cyan	5	No	Yes
◆ Custom Text Registration	–	No	Yes
► Tracking Information Print	–	No	Yes
◆ Tracking Information Print Setting	Disabled	No	Yes
◆ Print Information		No	Yes
• Unit Serial Number	Enabled	No	Yes
• Text	Disabled	No	Yes
• Account Job ID	Enabled	No	Yes
• Login Name/User Number	Enabled	No	Yes



Setup Items	Factory default setting	U	A
• Date/Time	Enabled	No	Yes
◆ Print Colour	Black	No	Yes
◆ Print Position		No	Yes
• Vertical position		No	Yes
- Print Upper Side of Paper	Disabled	No	Yes
- Print Lower Side of Paper	Enabled	No	Yes
• Horizontal position		No	Yes
- Print Left Side of Paper	Enabled	No	Yes
- Print Right Side of Paper	Disabled	No	Yes
◆ Select the Job to Print		No	Yes
• Copy	Enabled	No	Yes
• Print	Enabled	No	Yes
• Prints(Doc.Filing)	Enabled	No	Yes
• Internet Fax Receive*1	Enabled	No	Yes
• Fax Receive*2	Enabled	No	Yes
• List Prints	Enabled	No	Yes
▶ Initialize Private Data/Data in Machine*3	–	No	Yes
▶ Security code input*3	–	No	Yes
▶ Audit Log		No	Yes
◆ Security Control		No	Yes
• Audit Log	Disabled	No	Yes
◆ Storage/Send Settings		No	Yes
• Store Setting		No	Yes
- Stored to Storage	Enabled	No	Yes
• Send Settings		No	Yes
- Server Send	Disabled	No	Yes
- Hostname or IP Address (Required)	–	No	Yes
- Enable SSL	Off	No	Yes
- Port Number	514	No	Yes
- Port Number (Use SSL)	6514	No	Yes
◆ Save/Delete Audit Log		No	Yes
• Save Audit Log*4	–	No	Yes
• Delete Audit Log	–	No	Yes

*1 When an internet fax expansion kit is installed.

*2 When a facsimile expansion kit is installed.

*3 This setting is configured in setting mode on the machine.

*4 This setting is configured in setting mode on the web page.



Energy Save

U: General user; A: System administrator/Administrator

Setup Items	Factory default setting	U	A
● Energy Save (page 7-162)			
▶ Eco Setting		No	Yes
◆ Eco Recommendation Function Display	Disabled	No	Yes
◆ Display Message When Extending Transition Time to Preheat/Auto Power Shut-Off Mode	Disabled	No	Yes
◆ Mode Setting	Custom	No	Yes
◆ Preheat Mode Setting	1min.	No	Yes
• Turn off Panel Display during pre-heat mode	Enabled	No	Yes
◆ Auto Power Shut-Off*	Enabled	No	Yes
◆ As soon as the remote job is finished, enter Auto power shut off mode.	Enabled	No	Yes
◆ Fix transition time.	Enabled	No	Yes
• Auto Power Shut-Off Timer	1min.	No	Yes
◆ Change transition time by time of day.	Auto	No	Yes
◆ Sleep Mode Power Level	Low Power	No	Yes
▶ Eco Scan Setting		No	Yes
◆ Eco Scan Setting	Enabled	No	Yes
• Home Screen	Disabled	No	Yes
• Copy	Disabled	No	Yes
◆ Image Send	All Enabled	No	Yes
◆ Document Filing	All Enabled	No	Yes
◆ System Settings	Enabled	No	Yes
◆ Sharp OSA	All Enabled	No	Yes
▶ Energy Saving Pattern List		No	Yes
◆ Automatic Update Pattern	–	No	Yes
◆ Original Eco Pattern	–	No	Yes
▶ Specific Date Operation Settings	–	No	Yes
▶ Power ON/OFF Schedule Setting	–	No	Yes
▶ Toner Save Mode	All Invalid	No	Yes



System Control

U: General user; A: System administrator/Administrator

Setup Items	Factory default setting	U	A
● System Control (page 7-169)			
▶ Job Log		No	Yes
◆ Job Log Operation	–	No	Yes
• Job Log	–	No	Yes
• Save Job Log		No	Yes
- The Number of Job Log to Notify by E-mail	50000	No	Yes
• Delete Job Log	–	No	Yes
◆ View Job Log	–	No	Yes
▶ Data Import/Export (CSV Format)	–	No	Yes
▶ Storage Backup	–	No	Yes
▶ Device Cloning	–	No	Yes
▶ Address Book Forward*	–	No	Yes
▶ Filing Data Backup	–	No	Yes
▶ Storing/Calling of System Settings		No	Yes
◆ Store Current Configuration	–	No	Yes
◆ Restore Configuration	–	No	Yes
▶ Reset Settings		No	Yes
◆ Restore Factory Defaults	–	No	Yes
◆ Reset the NIC	–	No	Yes
▶ Optimization of a Hard Disk		No	Yes
◆ Optimization of a Hard Disk	–	No	Yes
▶ Status Message		No	Yes
◆ Status Message	–	No	Yes
◆ Alerts Message	–	No	Yes

* This setting is configured in setting mode on the machine.



Image Quality Adjustment

U: General user; A: System administrator/Administrator

Setup Items	Factory default setting	U	A
● Image Quality Adjustment (page 7-173)			
▶ Collective Adjustment		No	Yes
◆ Registration Adjustment*1	–	No	Yes
◆ Fusing Cleaning Mode*1	–	No	Yes
◆ MC Cleaning Mode*1, *2	–	No	Yes
◆ Black Letter/Black Line Width Adjustment	0	No	Yes
◆ Black Streak Reduction	Disabled	No	Yes
◆ Display warning message for black streaks detection.	Disabled	No	Yes
▶ Copy Image Quality		No	Yes
◆ Quick Image Quality Adjustment	2	No	Yes
◆ Colour Balance (Colour)	All 0	No	Yes
◆ Colour Balance (Black & White)	All 0	No	Yes
◆ Color Copy Black Component Amount Adjustment	All 0	No	Yes
◆ Density Adjustment when [Auto] is selected for Exposure		No	Yes
• Colour	Document Glass, Document Feeder: 5 (Normal)	No	Yes
• B/W	Document Glass, Document Feeder: 5 (Normal)	No	Yes
◆ Sharpness	2	No	Yes
◆ Image Quality Priority		No	Yes
• Auto	0	No	Yes
• Text/Prtd.Photo	0	No	Yes
▶ Print Image Quality		No	Yes
◆ Quick Image Quality Adjustment		No	Yes
• Colour	2	No	Yes
• B/W	2	No	Yes
◆ Colour Balance (Colour)	All 0	No	Yes
◆ Colour Balance (Black & White)	All 0	No	Yes
◆ Exposure Adjustment		No	Yes
• Colour	3 (Normal)	No	Yes
• B/W	3 (Normal)	No	Yes
◆ Colour Line Width Adjustment	5	No	Yes
▶ Scan Image Quality		No	Yes
◆ RGB Adjust	All 0	No	Yes
◆ Sharpness	3 (Normal)	No	Yes
◆ Contrast	3 (Normal)	No	Yes
▶ Colour Profile Settings*3	–	No	Yes
▶ Common Functions*1	–	No	Yes
◆ Auto Colour Calibration (for Copy)	–	No	Yes
◆ Auto Colour Calibration (for Print)	–	No	Yes
◆ Copy Calibration by Screen	–	No	Yes
◆ Printer Calibration by Screen	–	No	Yes
◆ Density Smoothing Adjustment	Middle	No	Yes
▶ Remove Toner Cartridge*1	–	No	Yes

* 1 This setting is configured in setting mode on the machine.

* 2 MX-5050V/MX-5070V/MX-6050V/MX-6070V only.

* 3 This setting is configured in setting mode on the web page.



Initial Installation Settings

U: General user; A: System administrator/Administrator

Setup Items	Factory default setting	U	A
● Initial Installation Settings			
▶ Condition Settings		No	Yes
◆ Name	–	No	Yes
◆ Machine Code	–	No	Yes
◆ Machine Location	–	No	Yes
◆ Memo	–	No	Yes
◆ Clock Adjust	–	No	Yes
• Current Date	–	No	Yes
• Specify Time Zone	–	No	Yes
• Date&Time Settings	–	No	Yes
◆ Synchronize with Internet Time Server	Disabled	No	Yes
◆ Daylight Saving Time Setting	–	No	Yes
◆ Preheat Mode Setting	1min.	No	Yes
• Turn off Panel Display during pre-heat mode	Enabled	No	Yes
◆ Auto Power Shut-Off	Enabled	No	Yes
• Fix transition time.	Enabled	No	Yes
◆ Display Message When Extending Transition Time to Preheat/Auto Power Shut-Off Mode	Disabled	No	Yes
◆ Sleep Mode Power Level	Low Power	No	Yes
▶ Network Quick Settings	–	No	Yes
▶ Paper Tray Settings	–	No	Yes
▶ Product Key	–	No	Yes



STATUS

Status

Machine Identification

The Machine Identification displays the system information of the machine. It displays the model name, current status, and machine location.

Item	Description
[Update] key	Updates the information displayed.
Unit Serial Number	Indicates the serial number of the machine.
Name	If [Name] is not set, [Not Set] appears. When you tap the [Not Set] key, the [Machine Identification] screen appears.
Model Name	Displays the standard model name of the machine.
Machine Location	The information entered in the [Machine Location] item in [Machine Identification] appears. If no name has been set, [Not Set] appears.
Current Status	Displays the current status of the machine. If two or more errors occur at the same time, only one status is displayed according to the priority order. The errors and machine conditions are displayed in the following priority order. <ul style="list-style-type: none"> • Printer Error • Account Limit • Incorrect Paper • Overdue service maintenance • Paper jammed • Marker supply missing • No toner • Replace waste toner box. • Cover open • The paper is not available. • Input tray empty • Specified input tray missing • Specified output tray full • Offline • Printer Warning • Toner low • Paper low • Input tray missing • Output Tray Full • Output tray near full • Near to overdue service maintenance • Ready • Auto power shut-off • Warming Up • Busy
Memo	Displays text that the administrator entered. If you have logged in as an administrator, you can enter a memo. If no name has been set, [Not Set] appears. When you tap the [Not Set] key, the Machine Identification screen appears.



Item	Description
Supply Status	Displays the current status of supplies.
	If staples are installed, their status is displayed.
Paper Input Tray Status	Displays the current status of the paper trays installed in the machine.
[Reboot the MFP] key	Displays the restart screen. (Administrator rights are required.)
[Enter the Power Save Mode] key	Displays the power save mode screen. (Administrator rights are required.)

Total Count

This function shows the page count in each mode.



- Pages printed directly from the machine such as list prints are included in the "Other Prints" count.
- The items displayed (or printed) will vary depending on the machine specifications and peripheral devices installed.
- Before printing the number of pages used, select "Settings (administrator)" → [Status] → [Data List] → [List for Administrator].
- In All Sending Address List, the following items are handled by 2-sided printing on an item basis.
 - Individual List
 - Group List

Device Status

This screen shows the device status.

Item	Description
[Update] button	Updates the information displayed.
Paper Input Tray Status	Displays the current status of the paper trays installed in the machine.
Output Tray Status	Displays the current status of the output tray installed in the machine.
Supply Status	Displays the current status of supplies.
	If staples are installed, their status is displayed.
Device Configuration	Displays the information of options installed in the machine.
HDD Status	Displays the usage status of the hard disk drive.



Network Status

The Network Status screen shows the general status information and the statuses relevant to, TCP/IP, DNS, and WINS protocols.

Item	Description
General	<p>Displays the information common to the network.</p> <ul style="list-style-type: none"> • Connection Type: Displays the network connection type. • Link Status: Displays the data transfer rate of the NIC and cable information. • Duplex Mode: Displays the duplex mode of the NIC. • Hardware Address: Displays the MAC address of the NIC. • Device Name: Displays the device name. • Domain Name: Displays the domain name. • Reception Level (Max. 100): Displays the reception level of the wireless LAN. (When connected to a wireless network)
TCP/IP	<p>Displays the current status of the TCP/IP protocol.</p> <ul style="list-style-type: none"> • TCP/IP: Shows use of TCP/IP. • IPv4 Settings: Displays the IPv4 protocol settings. <ul style="list-style-type: none"> • DHCP: Selects whether or not the IP address is obtained from the DHCP server. • IPv4 Address: Displays the IPv4 address to which the notification is sent. • Subnet Mask: Displays the current subnet mask. • Default Gateway: Displays the current default gateway. • IPv6 Settings: Displays the IPv6 status. <ul style="list-style-type: none"> • IPv6: Displays whether IPv6 is enabled. • DHCPv6: Displays the status of the DHCPv6 server. • Manual Address: Displays the IPv6 address that has been manually specified. • Default Gateway: Displays the current default gateway. • Link-Local Address: Displays the link-local address. • Stateless Address 1: Displays the stateless address. • Stateless Address 2: Displays the stateless address. • Stateful Address: Displays the stateful address.
DNS	<p>Displays the status of the DNS server.</p> <ul style="list-style-type: none"> • IPv4 Settings: <ul style="list-style-type: none"> • Primary Server: Displays the current IP address of the primary DNS server. • Secondary Server: Displays the current IP address of the secondary DNS server. • IPv6 Settings: <ul style="list-style-type: none"> • Primary Server: Displays the current IP address of the primary DNS server. • Secondary Server: Displays the current IP address of the secondary DNS server. • Domain Name: Displays the current domain name of the DNS server.
WINS	<p>Displays the status of the WINS server.</p> <ul style="list-style-type: none"> • Primary Server: Displays the current IP address of the primary WINS server. • Secondary Server: Displays the current IP address of the secondary WINS server. • Primary Server (DHCP): Displays the current IP address of the primary WINS server (DHCP). • Secondary Server (DHCP): Displays the current IP address of the secondary WINS server (DHCP). • Scope ID: Displays the current WINS scope ID. • Scope ID (DHCP): Displays the current WINS scope ID (DHCP).

Firmware Version

Shows the firmware version of the machine as a list.



Power Reset

The Power Reset screen enables you to restart the machine or enter the power save mode.



This function requires administrator rights.

Item	Description
Reboot the MFP	Reboots the machine. Tapping the [Execute] key opens the Restart screen, and then tapping the [Execute] key again restarts the machine.
Enter the Power Save Mode	Shifts the machine to power save mode. Tap the [Execute] key to open the power save mode screen.

Data List

Lists showing the settings and information registered in the machine can be printed.



The two-sided or one-sided list printing setting is determined by Device Control - Data List - 1-Sided/2-Sided.

List for User

List name	Description
Machine Status List	This list shows information needed by regular users, such as hardware statuses, software statuses, printer environment settings, and paper tray settings.
Printer Test Page	This is used to print the PCL Symbol Set List, various font lists, and the NIC page (network interface settings, etc.). <ul style="list-style-type: none"> • PCL Symbol Set List • PCL Internal Font List • PCL Extended Font List • PS Font List • NIC Page
Sending Address List	Lists can be printed of various addresses stored in the machine. <ul style="list-style-type: none"> • Individual List • Group List • Memory Box List
Document Filing Folder List	This shows the folder names for document filing.



List for Administrator

You can print out the lists and reports that only the administrator can refer to.

When using "Image Sending Activity Report (Internet Fax)" in Image Sending Activity Report (Auto), select "Settings" → [System Settings] → [Image Send Settings] → [Internet Fax Settings] → [Receive Settings] → [2-Sided Printing of Received Data], enabling you to specify 1-sided or 2-sided printing.

When using "Image Sending Activity Report (Fax)" in Image Sending Activity Report (Auto), select "Settings" → [System Settings] → [Image Send Settings] → [Fax Settings] → [Receive Settings] → [2-Sided Printing of Received Data], enabling you to specify 1-sided or 2-sided printing.

- Home Screen List
- Copy Settings List
- Printer Settings List
- Image Send Settings
 - Metadata Set List
 - Common Settings List
 - Scan Settings List
 - Fax Settings List
 - I-Fax Settings List
- Document Filing Settings List
- Sharp OSA Settings List

Common

Lists of the administrator settings for the following modes can be printed.

- Paper Settings List
- Machine Identification Settings List
- Operation Settings List
- Keyboard Settings List
- Device Control List

Network Settings

- Network Settings List

Security Settings

- Security Settings List

Energy Save Setting

- Energy Save List

Image Quality Adjustment

- Image Quality Adjustment List

Image Sending Activity Report

The following Image Sending Activity Reports can each be separately printed.

- Image Sending Activity Report (Fax)
- Image Sending Activity Report (Scan)
- Image Sending Activity Report (Internet Fax)

Data Receive/Forward List

The following lists showing reception settings and forwarding settings can be printed.

- Allow/Reject Number List
- Allow/Reject Mail & Domain Name List
- Inbound Routing List
- Document Admin List



ADDRESS BOOK

Address Book

Transmission destinations (contacts) such as fax and Scan to E-mail addresses, and groups of transmission destinations, can be stored in the address book. For the procedure for storing contacts and groups using the machine's touch panel, see "[ADDRESS BOOK \(page 1-98\)](#)". In setting mode, a list of stored contact and group information is displayed.

To edit a contact or group, select the name of the contact/group. To add a new contact or group, click the [Add] key.

Item	Description
Type	Select the contact or group.
Search Number	Store a number that can be used to search for a contact or group.
Address Name	Store a name for an address.
Initial	Store an initial that can be used to search for a contact or group.
Category	Enter a category for a contact or group.
Register this Address to be added to the [Frequent Use] index.	Add a contact to the "Frequent Use" index.
Address Public Setting	Set whether the address will be shared with all users or only selected users. If you select [Select user], click the user selection buttons to select the users with whom the address will be shared.
Share also to the following group	When this function is enabled, you can select a previously stored group from the list below and share the address with that group.
E-mail	
E-mail Address	To store a new address, select [New Address] and enter the address in the address entry field.
Global Address Search	To search for an address stored as a global address, click this key and select the address from the list.
File Type	Select the file format used for a scanned image. When [OCR] is enabled on the MX-3060V/MX-3070V/MX-3560V/MX-3570V/MX-4060V/MX-4070V/MX-5070V/ MX-6070V, text in the scanned data is automatically recognized. For PDF, the text information is embedded in the PDF. For PDF, RTF, TXT(UTF-8), DOCX, XLSX, or PPTX, the recognized text is saved in the corresponding format. Black & white: Select the compression format used for saving black & white images. Colour/Greyscale: Select the compression format used for saving colour/greyscale images. To enhance black text when scanning, select "Bk Letter Emphasis".
Set as Default used	Set an address as a default address.



Item	Description
Fax	
Fax Number	To store a new fax number, select [New Address] and enter the fax number in the fax number entry field.
Global Address Search	To search for a fax number stored as a global address, click this key and select the fax number from the list.
Transmission Mode	Select the communication speed and International Correspondence Mode.
Set as Default used	Set an address as a default address.
Internet Fax	
Internet Fax Address	To store a new address, select [New Address] and enter the address in the address entry field.
Global Address Search	To search for an address stored as a global address, click this key and select the address from the list.
Compression Mode	Set the compression format used for transmitted images.
Request Internet Fax Reception Report	Select whether or not you wish to receive a reception report by e-mail after transmission is completed.
Set as Default used	Set an address as a default address.
Direct SMTP	
Direct SMTP Address	To store a new address, select [New Address] and enter the address in the address entry field.
Add Hostname or IP Address.	When the receiving machine is set to only receive e-mail from specific addresses, enter the specified specific e-mail address in the [Direct SMTP Address] text box. Select the "Add Hostname or IP Address." checkbox and enter the host name or IP address of the receiving machine in the [Hostname or IP Address] text box. Example: When the e-mail address of the receiving machine is "user@sample_domain.com" and the IPv4 address is "192.168.123.45" Enter "user@sample_domain.com" in the [Direct SMTP Address] text box and enter "192.168.123.45" in the [Hostname or IP Address] text box.
Compression Mode	Set the compression format used for transmitted images.
Set as Default used	Set an address as a default address.
FTP	
FTP Address	To add a new address, select [New Address] and enter the address in [Hostname or IP Address].
File Type	Select the file format used for a scanned image. When [OCR] is enabled on the MX-3060V/MX-3070V/MX-3560V/MX-3570V/MX-4060V/MX-4070V/MX-5070V/ MX-6070V, text in the scanned data is automatically recognized. For PDF, the text information is embedded in the PDF. For PDF, RTF, TXT(UTF-8), DOCX, XLSX, or PPTX, the recognized text is saved in the corresponding format. Black & white: Select the compression format used for saving black & white images. Colour/Greyscale: Select the compression format used for saving colour/greyscale images. To enhance black text when scanning, select "Bk Letter Emphasis".
Directory	Specify a directory in the FTP server to be used for transmission.
User Name	Enter a user name in the FTP server to be used for transmission.
Password	Enter the password associated with the entered user name.



Item	Description
Enable SSL	Use SSL to encrypt data before transmission.
Use PASV mode	Send data to an FTP server in PASV mode.
Enable Hyperlink to FTP server to be e-mailed	When sending data to an FTP server, send the data to the e-mail address that is specified in the hyperlink to the FTP server.
Set as Default used	Set an address as a default address.
Desktop	
Desktop Destination	To add a new address, select [New Address] and enter the address in [Hostname or IP Address].
Please enter Port Number.	Enter the port of the destination computer.
Process Directory	Specify the directory to which the data is to be sent.
File Type	Select the file format used for a scanned image. When [OCR] is enabled on the MX-3060V/ MX-3070V/MX-3560V/MX-3570V/MX-4060V/MX-4070V/MX-5070V/ MX-6070V, text in the scanned data is automatically recognized. For PDF, the text information is embedded in the PDF. For PDF, RTF, TXT(UTF-8), DOCX, XLSX, or PPTX, the recognized text is saved in the corresponding format. Black & white: Select the compression format used for saving black & white images. Colour/Greyscale: Select the compression format used for saving colour/greyscale images. To enhance black text when scanning, select "Bk Letter Emphasis".
User Name	Enter a user name in the computer to be used for transmission.
Password	Enter the password associated with the entered user name.
Enable SSL	Use SSL to encrypt data before transmission.
Set as Default used	Set an address as a default address.
Network Folder	
Network Folder Path	To store a new path, select [New Address] and enter the path in the path entry field.
User Name	Enter a user name in the computer to be used for transmission.
Password	Enter the password associated with the entered user name.
File Type	Select the file format used for a scanned image. When [OCR] is enabled on the MX-3060V/ MX-3070V/MX-3560V/MX-3570V/MX-4060V/MX-4070V/MX-5070V/ MX-6070V, text in the scanned data is automatically recognized. For PDF, the text information is embedded in the PDF. For PDF, RTF, TXT(UTF-8), DOCX, XLSX, or PPTX, the recognized text is saved in the corresponding format. Black & white: Select the compression format used for saving black & white images. Colour/Greyscale: Select the compression format used for saving colour/greyscale images. To enhance black text when scanning, select "Bk Letter Emphasis".
Enable Hyperlink to Network Folder to be e-mailed	When sending data to a shared folder, send the data to the e-mail address that is specified in the hyperlink to the shared folder.
Set as Default used	Set an address as a default address.

Category Setting

A category can be renamed for greater ease of use.

Delete the previously entered characters and enter a new name (up to 127 characters).

The factory default names are "Category 1" to "Category 32".



DOCUMENT OPERATIONS

Document Operations

Document Filing

Data saved by Document Filing can be manipulated from the Web.

Main Folder

The files that are in the Main Folder can be displayed. A specified file can be manipulated by clicking [Print], [Send], [Move], or [Delete]. If the file to be manipulated has a password, enter the password in “PIN Code/Password of File”.

Item	Description
Display Style	Saved files can be displayed in list format or thumbnail format.
Job Classification	The saved files that are displayed can be filtered by job.
Display Items	Set the number of files that are displayed.

Quick File Folder

Files in the Quick File Folder can be displayed. A specified file can be manipulated by clicking [Print], [Send], [Move], or [Delete].

Item	Description
Display Style	Saved files can be displayed in list format or thumbnail format.
Job Classification	The saved files that are displayed can be filtered by job.
Display Items	Set the number of files that are displayed.

Custom Folder

The files that are in the Custom Folder can be displayed. A specified file can be manipulated by clicking [Print], [Send], [Move], or [Delete]. If the file to be manipulated has a password, enter the password in “PIN Code/Password of File”.

Item	Description
Index	The displayed Custom Folder names can be filtered by index.
Display Items	Set the number of files that are displayed.



Search

Use these settings to enter search conditions. A specified file can be manipulated by clicking [Print], [Send], [Move], or [Delete]. If the file to be manipulated has a password, enter the password in “PIN Code/Password of File”.

Item	Description
User Name	Enter the user name. (Up to 32 characters)
Select from User List	Click the [Setup] button and search for users from the list.
Login Name	Set the number of files that are displayed.
Search Folder	Set the folder.
File Name	Enter a file name. (Up to 30 characters)
PIN Code/Password of File	Enter the password that is set for the file (5 to 32 digits).
Stored Date	Set the date and time the file was saved.

Search Result

Use these settings to enter search conditions. A specified file can be manipulated by clicking [Print], [Send], [Move], or [Delete]. If the file to be manipulated has a password, enter the password in “PIN Code/Password of File”.

Item	Description
Display Style	The files that were found can be displayed in list format or thumbnail format.
Job Classification	The found files can be filtered by job.
Display Items	Set the number of files that are displayed.

File Batch Print

Multiple files can be printed at once by batch printing. Search for the files using search conditions, and then select multiple files from the displayed search results.

If you want to use the number of copies set when each file was saved by Document Filing, select “Apply the Number of Copies Stored in Each File”. If you want to set a different number of copies, enter the desired number in “Enter the Number”. Click [Print] to print the file. To have the file deleted after printing, select the “Print and Delete the Data” checkbox.

Item	Description
Search Condition	
User Name	Enter the user name. (Up to 32 characters)
Select from User List	Click the [Setup] button and search for users from the list.
Search Folder	Set the folder.
File Name	Enter a file name. (Up to 30 characters)
PIN Code/Password of File	Enter the password that is set for the file. (5 to 32 digits)
Search Result	
Job Classification	The found files can be filtered by job.
Billing Code	
Main Code	Select this checkbox, and then enter the main code. (32 characters or less)
Sub Code	Select this checkbox, and then enter the sub code. (32 characters or less)



Submit Print Job

You can print a file on your computer.

Files that can be printed are PDF, TIFF, JPEG, PCL, PS*1, XPS, DOCX*2, PPTX*2, and XLSX*2 files with extensions pdf, tif, tiff, jpeg, jpg, jpe, jfif, pcl, ps*1, xps, docx*2, pptx*2, and xlsx*2. Available only if the MFP supports PostScript. Enter the password for the encrypted PDF data on Spool Queue of the Job Status screen.

*1 On the MX-2630N/MX-3050V/MX-3550V/MX-4050V/MX-5050V/MX-6050V, the PS3 expansion kit is required.

*2 On the MX-2630N/MX-3050V/MX-3550V/MX-4050V/MX-5050V/MX-6050V, the Direct print expansion kit is required.

Print Settings

Select print settings. Select the file you want to print in “Select File”, select settings, and then click [Print].

Item	Description
Copies	Set the number of copies to be printed.
Paper Size	Set the print size.
Orientation	Select portrait or landscape for the print orientation.
2-Sided Print	Select one-sided printing, two-sided printing (booklet), or two-sided printing (tablet).
Output	If printing by set, select the “Print per Unit” checkbox.
Separator Page	Select to insert separator pages. Specify whether separator pages are to be added in front of or behind each set. Select the paper tray with the paper you want to use from the paper trays.
Staple	Select staple settings.
B/W Print	Print the file in black & white.
Fit To Page	Print with the file expanded to the full paper size.
Print What	Select whether blank sheets are to be deleted or the entire book is to be printed when printing an Excel file.
Output Tray	Select the output tray for the print job.
Quick File	Save the print data in the Quick File Folder of the machine.
Print Glossy	Select this checkbox if the print job will be printed on glossy paper.
Billing Code	Select the checkbox of the Billing Code to assign, and then enter the billing code.

“DirectOffice™ is a product of CSR Imaging US, LP.

DirectOffice™ is a trademark of CSR Imaging US, LP, registered in the United States and other countries, used with permission.”



USER CONTROL

User Control

User List

This is used to store, edit, and delete users when user authentication is enabled.

- **[Add] key**
Adds a new user.
- **[Delete All Users] key**
Deletes all registered users. (Excluding users stored as factory default.) Only the administrator of the machine can use this function.
- **[Delete All Auto-registered users] key**
Deletes all auto-registered users.
 - ▶ [Users auto-registered \(page 7-64\)](#)
- **[Delete Your Information for External Connect] key**
Delete the External Connect cache used by the selected user. [Store user authentication information for External Connect] must be enabled to use this function.
- **[Delete All Information for External Connect] key**
Only the administrator of the machine can perform this action. Delete all External Connect caches. [Store user authentication information for External Connect] must be enabled to use this function.
- **User List**
This shows the users stored as factory default and the currently stored users. An asterisk [*] appears in front of the user name of auto-registered users.
When you select a user name, the user edit or delete screen appears.



The [Vender] and [Vender2] options are displayed only when the vender is connected.

Storing a user

When you tap the [Add] key, the registration screen appears. Up to 1000 groups can be registered.

For information on the settings, see "[Settings \(page 7-61\)](#)".

Editing and deleting a user

When you select a user from the list, the user edit/delete screen appears.

For information on the settings, see "[Settings \(page 7-61\)](#)".

A user can be deleted using the [Delete] key.



- If the login authentication with a Fixed User is set, the "Delete All Users" option cannot be used.
- Users stored as factory default cannot be deleted.



Users stored as factory default

The following users are stored in the machine at the factory.

- Administrator: The administrator account of the machine, stored as factory default.
- System Administrator: The account for system maintenance, stored as factory default. This account cannot execute jobs.
- User: This is used when network authentication is used and a login name that is not stored in the machine is entered directly. (This cannot be selected from the login user screen.)
- Fixed User: An account to which the colour prohibited authority is granted.
- Other User: This is used when a print job is executed using invalid user information. (This cannot be selected from the login user screen.)

For settings related to each of the users, see the following table.

User Name	Admin	System Administrator	Users	Device Account	Other User
Login Name	admin	sysadmin	users	device account	Other
PIN Code/Password	(See "Start Guide.") ^{*1}	sysadmin ^{*1}	users ^{*1}	device account ^{*1}	–
My Folder	No	Main Folder	No	Main Folder	No
Authentication Server Settings	Login Locally				–
Pages Limit Group	Unlimited ^{*1}				
Authority Group ^{*2}	Admin	System Administrator Authority ^{*1}	User ^{*1}	Colour Prohibited Authority ^{*1}	Guest ^{*1}
Favourite Operation Group	Following the System Settings ^{*1}				
Default Billing Code	Not Set ^{*1}				

^{*1} Items that can be changed

^{*2} For detailed information, see "[Authority Group \(page 7-69\)](#)".



Settings

Item	Description
User Name	Store a user name consisting of up to 255 characters. This user name is used as the key name in the authentication screen, the user name for document filing, and the sender name.
Apply User Name to Log-in Name.*1	Select this <input checked="" type="checkbox"/> to enter the entered user name in the login name.
Initial (Optional)	This determines where the user name will appear in the user list. Enter a maximum of 10 characters for the initials.
Index	Select a custom index to be stored. The custom index names are the same as those used in the address book.
User Number*2	Enter a user number in 5 to 8 digits.
Login Name*1	Enter the login name that is used when authentication by login name and password is enabled (up to 255 characters). (The login name must be unique.)
Password*1, 3	Enter the password, consisting of 1 to 255 characters, that is used for user authentication by login name and password (the password is optional). After entering the password, enter once again in "Password (for confirmation)".
E-mail Address	Enter the e-mail address that is used in the sender list and for LDAP authentication (up to 255 characters).
Home Directory Path	Enter a maximum of 127 full-width/half-width characters for the home directory path.
Use Login Name for User Authentication	Set whether or not the login name for user authentication will be the same as the user name for home directory path authentication.
User Name	Enter a maximum of 127 full-width/half-width characters for the user name for home directory path authentication.
Password	Enter a maximum of 255 numeric digits for the password for home directory path authentication.
Authentication Settings*1	Select either [Login Locally], [Network Authentication] (when LDAP is enabled) or [Active Directory] (when Active Directory is enabled) for authentication.
Authentication Server	When the [Network Authentication] is selected, select the server to be used for user authentication from the LDAP server list that is stored using Setting mode (Web version).
Organization/Group	Set a group to which the user belongs. Up to 8 groups can be assigned.
Pages Limit Group	Specify the page limit for the user by selecting one of the stored page limit groups. The factory default setting is [Unlimited]. For more information, see " Pages Limit Group (page 7-68) ".
Authority Group	Specify the user authority by selecting one of the stored authority groups. The factory default setting is [User]. For more information, see " Authority Group (page 7-69) ".
Favourite Operation Group	The favourite operation group is displayed when the user logs in. The factory default setting is [Following the System Settings]. To change the settings, select [User Control] in Setting mode (Web version).
Default Billing Code	Set the Main Code and Sub Code when the user logs in. The factory default setting is [Not Set].
My Folder	Store a folder to be used for document filing as the dedicate user folder (or My Folder). A stored folder can be selected, or you can create and specify a new folder.

*1 It is not displayed when "User Number" is selected for the authentication method.

*2 It is displayed when "User Number" is selected for the authentication method.

*3 Not required when network authentication is used, as the password stored in the LDAP server is used.



Custom Index

You can change the custom index name.

Tap the custom index name on the list to edit it.

Delete the previously entered characters and enter a new name (up to 127 characters).

Organization /Group List

This is used to store user groups.

Tap each group name to enter them directly.

Default Settings

User Authentication

This setting enables or disables user authentication and specifies the authentication method.

When the user authentication is enabled, each user of the machine is registered. When a user logs in, the separate authentication settings apply to the user. This function allows greater control of security and cost management than that on previous machines.

Even if user information is not stored on the machine, you can directly enter the user information stored in an LDAP server to log in the machine if necessary. In this case, the authentication information of the "User" being stored as factory default applies to the login user. For more information, see "[Users stored as factory default \(page 7-60\)](#)".



- For the procedure for storing users, see "[User List \(page 7-59\)](#)".
- For details on login procedures when user authentication is enabled, see "[USER AUTHENTICATION \(page 1-32\)](#)".

User Authentication

When [User Authentication] is enabled, the authentication screen appears before an operation is carried out in any mode except the job status screen*.

Log in as an already registered user.

After logging in, you can move freely through the modes.

*The login screen appears when a document filing file is used or when a broadcast transmission is reattempted from the job status screen.

Authentication Settings

Set the location where user authentication is to be enabled.

Local: User authentication by the machine.

LDAP: User authentication by LDAP server.

Active Directory: User authentication by Active Directory.

Default Network Authentication Server Setting

Use this to set the default network authentication server.

When you log into Setting mode (Web version) or send a print job to the machine using user information that is not registered in the machine, the authentication server is not known. This setting is used to select one of the LDAP servers registered in the machine as the authentication server.



When login is performed by network authentication using user information that is not registered in the machine, the login user will be the "User" registered as factory default. For more information, see "[Users stored as factory default \(page 7-60\)](#)".



Perform network server access control

Register the access control information for page count limits, authorities, and favourite operations can be registered on a network server in advance. By using this network server for network authentication, perform the user authentication based on the registered access control information.

Use this function when user authentication is performed by network authentication using an LDAP server or a directory service (Active Directory, etc.).

Before using this function, configure settings for authentication by network server, obtain control numbers for the "Pages Limit Group", "Authority Group", "Favourite Operation Group", and "My Folder" (including base settings for each group), and associate these with the control numbers registered in the machine.

To use this function, add the properties associated with "Pages Limit Group", "Authority Group", "Favourite Operation Group", and "My Folder" to the directory information of the network server used for user authentication.

The property information is indicated below. Settings previously stored in the machine cannot be changed.

Property	Name of property in factory default state	Setting
Pages Limit Group	pagelimit	Registration number of Pages Limit Group registered in the machine, or a group name previously registered in the machine. Unlimited: unlimited
Authority Group	authority	Registration number of Authority Group registered in the machine, or a group name previously registered in the machine. Admin: admin User: user Guest: guest
Favourite Operation Group	favourite	Registration number of Favourite Operation Group registered in the machine, or a group name previously registered in the machine. Following the System Settings: systemsettings
My Folder	myfolder	Folder name of user folder stored in the machine. Do not enter if the default folder is specified.

Rename the properties that the machine obtains from the LDAP server as follows. In "Settings", select [Network Settings] → [LDAP Settings]. From the Global Address Book setting screen that is displayed, select [Linkage with User Control Function] and then select [Pages Limit Group], [Authority Group], [Favourite Operation Group] and [My Folder].

The [Pages Limit Group], [Authority Group], and [Favourite Operation Group] information that is registered in each machine determines the authority and settings that the user is actually granted. To use this function to ensure that users are granted the same authority and settings on any machine, register the [Pages Limit Group], [Authority Group], and [Favourite Operation Group] information with the same authority so that they will be registered in each machine using the same registration numbers.

For [My Folder], register the folder having the same name in [Custom Folder] in each machine.

The directory information of the network server that is used cannot be changed from the machine. Consult the administrator of the network server.



If 1000 users have already been manually registered, login will not be possible. Please delete old or unused user name. Consult the administrator of the machine.



- If Access Control is enabled and the access control information cannot be acquired from the authentication server, user authentication will not be possible.
- If a user that is registered in the machine is authenticated by network authentication, the user registration settings in the machine will be given priority for the page count limit group, authority group, favourite operations group, and my folder.
- If the access control obtained from the LDAP server is not registered in the machine, the factory default user authority will be applied.
- When this function is not enabled and a user is authenticated by network authentication as a non-registered user, the factory default user authority will be applied.

Users auto-registered

When you log in by network authentication, your user information is automatically registered in the machine. The information stored is as follows:

Item	Description
User Name	This information is acquired from the authentication server.*
Initial	1
Index	User1
Card ID	–
PIN Code/Password	–
Authentication Server Settings	–
Authentication Server	Network Authentication
E-mail Address	When Access Control is enabled, this information is acquired from the authentication server.
My Folder	
Pages Limit Group	
Authority Group	
Favourite Operation Group	

* If the user name cannot be acquired by network authentication, the first 16 characters of the text string used as the login name for network authentication is applied.

Authentication Method Setting

This selects the authentication method. When using user authentication, be sure to configure this setting first. The items to be configured for users stored after setting the user authentication method vary depending on the selected authentication method.

Authenticate a User by Login Name and Password

Standard authentication method using a login name and password.

Authenticate a User by Login Name, Password and E-mail Address

This authentication also checks the e-mail address, in addition to the login name and password of the user.

Authenticate a User by User Number Only

Use this option for simple authentication if you skip the network authentication.



- The login screen will vary depending on the authentication method that is selected. For details, see "[USER AUTHENTICATION \(page 1-32\)](#)".
- When "Authenticate a User by User Number Only" is selected for the authentication method, network authentication cannot be used.



Device Account Mode Setting

A specific user can be registered as an auto login user. When this option is enabled, the registered user can log in the machine automatically.

This function can eliminate each login procedure on the authentication screen and apply the selected user settings (such as network authentication and favourite operations). As an example, this enables uses such as "authentication for colour copying only".

Also, you can temporarily log in as a user other than the auto login user, and operate the machine with the privileges of this user. To allow other users to log in temporarily when [Device Account Mode] is enabled, select [Allow Login by Different User].



- If you have logged in as the Auto Login user, and if you have failed automatic login due to some reasons or if you do not have the administrator's privileges, you cannot use the general setting modes or Setting mode. In that case, the administrator should tap the [Admin Password] key on the Setting mode screen and log in again.
- To log in as a user other than a fixed user when [Allow Login by Different User] is enabled, tap the [Logout] key to cancel the fixed user login state. When the user authentication screen appears, log in as the desired user again. After you have used the machine, tap the [Logout] key to log out as the current user.

Login User

This setting is used to select the auto login user when auto user login is enabled.

Cache User Information

Set whether or not automatically registered users are created. Externally authenticated users in Sharp OSA can also be automatically registered.

Cache Period

Select the cache period for user information.

To set the cache period, [Cache User Information] must be enabled.

Cache Password for Authentication

Set whether or not password information is retained as cache information when a user is cached.

Store user authentication information for External Connect

Set whether or not authentication information for connection to the cloud is retained as cache information.

When this setting is enabled, the authentication information of a successfully authenticated user is retained to enable smooth authentication when the user subsequently logs in.

When this setting is disabled, the previously retained cloud connection authentication information of all users is deleted and authentication information is no longer retained.

Card Setting

Use IC Card for Authentication

Use these settings for authentication and for use of a HID or other IC card.

Request Password at IC Card Authentication

This can be enabled when "Authentication Settings" is "Active Directory" and "Use IC Card for Authentication" is enabled. When enabled, a password must be entered each time authentication is performed by IC card. When disabled, a password is entered the 1st time the user logs in by IC card, and the password information is sent to the Active Directory server. When the user subsequently logs in, the password can be omitted.

Automatic Logout with a Card

At the point that the IC card is removed from the IC card reader/writer, the user is logged out. (The user can also log out by tapping the [Logout] key.)

Authentication Method Setting

Set the authentication method for IC cards.



Actions when the Limit of Pages for Output Jobs

This setting determines whether or not a job will be completed if the page limit is reached while the job is in progress. The following settings can be configured.

- Job is Completed even when the Limit of Pages is Reached
- Job is Stopped when the Limit of Pages is Reached
- After reaching to the page limit, cancel the job and delete the job during receiving

A Warning when Login Fails

When entering passwords, including administrator passwords, during user authentication, the number of incorrect password attempts is counted, and if the number of attempts reaches the specified number (three), the user account is locked, and the user is blocked from making any more attempts at authenticating their account until a period of five minutes has elapsed.

The number of incorrect entries made is counted separately for each user, and the count is reset when the correct password is entered.

This prevents an unauthorized person from attempting to guess a password. (The number of failed login attempts is retained even if the power is turned off.)



- Lockout only applies to the user who failed to login, not all users. Even if one user is locked out, the other users can still log in.
- When LDAP or Active Directory network authentication is used, lockout is executed by the server, not the machine. Select appropriate lockout settings on the server.
- If the same user has been locked out, the [Release Operation Lock Status] key is displayed in the "User Registration" screen for that user. An administrator can tap this key to carry out a manual clear.

Disabling of Printing by Invalid User

Printing by users whose information is not stored in the machine, such as printing without entering valid user information in the printer driver or printing of a file on an FTP server in Setting mode (Web version), can be prohibited.

Allow Remote Scanner Using Before Login.

This setting specifies whether scanning can be performed by remote operation before a user has logged in.

Automatically print stored jobs after login

When retention is enabled in the printer driver and print data has been spooled to the machine, you can have the spooled print data automatically print out when the user who enabled retention logs in.

Display Usage Status after Login

When user authentication is enabled, this setting specifies whether or not to display the page counts of a user when the user logs in.

Login Name Display

When user authentication is enabled, select whether the login name is shown or asterisks are shown.

Item	Description
Display login name	Show the login name.
Display Login Name with Asterisk "*****"	Hide the login name with asterisks.

Include Job Status in user authentication

When user authentication is enabled, this setting specifies whether or not to include the job status in user authentication.



Automatic Logout Setting

When user authentication is enabled, this setting specifies whether or not to enable automatic logout. The time until logout can be specified up to 240 seconds in increments of 10 seconds.

Case sensitivity of login name is enabled.

Set whether or not to make login names used at the time of user authentication case sensitive. If the checkbox is set to , login names with identical spelling but different cases (upper and lower) will be identified as different login names. Therefore, login names with identical spelling but different cases will be authenticated as user names of different users. If the checkbox is set to , case sensitivity for login names is disabled. Therefore, identically spelled user names with upper and lower case character differences will be authenticated as the user name of the same user.



If the selected checkbox is changed to , and identical user names with only upper and lower case character differences exist, the user names that have already been registered are identified as user names of different users.

Apply login name to the user name of network folder

Apply login name to the user name of network folder

Edit Help Display of Login Screen

Settings you have created here is displayed on the login screen.

User Information Print

Prints the following item lists.

- User List
- List of Number of Pages Used
- Page Limit Group List*
- Authority Group List
- Favourite Operation Group List*
- All User Information Print

Select each item and tap the [Print] key to print it out.

* Cannot be printed when no groups are stored.



- To specify [One Sided] or [Two Sided] printing in List Print, select "Settings" → [System Settings] → [Common Settings] → [Device Control] → [List Prints].
- In All User Information Print, the following items are handled by 2-sided printing on an item basis.
 - User List
 - List of Number of Pages Used
 - Page Limit Group List
 - Favourite Operation Group List

Reset Counter After Sending E-mail Status

After E-mail Status has been sent, the counter is reset.

This only appears when E-mail Status is enabled.



Pages Limit Group

This is used to register the page limit settings in advance for each group.

The page limit for each user is specified by selecting one of these registered groups when the user is registered.

- [Add] key

Use this to add a new group.

- List

This shows the currently stored groups. Selecting a group name displays the edit screen for that group.

Storing page limit groups

When you tap the [Add] key, the registration screen appears. Up to 20 groups can be registered.

For information on the settings, see "[Settings \(page 7-68\)](#)".

Editing a page limit group

Selecting a group from the list displays the edit screen for that group.

For information on the settings, see "[Settings \(page 7-68\)](#)".

To return a group to the factory default state, set "Select the Group Name to be the Registration Model" to "Unlimited" on the edit screen.

Settings

Item	Description
Group Name	Store a name of group (up to 32 characters).
Select the Group Name to be the Registration Model	Select one of the previously stored groups for use as a template for the new group. When selected, the settings of this group are applied.
Function Names	The name of the functions that can be configured is displayed. Set a limit for each function.
Page Limit	When [Prohibited] is selected for a mode, input from the mode is prohibited. When [Unlimited] is selected for a mode, there is no limit to the number of pages that can be input/output in that mode. When [Limited] is selected, enter a page limit (1 to 99999999 pages).

Machine Page Limit Setting

Sets the page limit for the machine.

Settings

Item	Description
Function Names	The name of the functions that can be configured is displayed. Set a limit for each function.
Page Limit	When [Prohibited] is selected for a mode, input from the mode is prohibited. When [Unlimited] is selected for a mode, there is no limit to the number of pages that can be input/output in that mode. When [Limited] is selected, enter a page limit (1 to 99999999 pages).



Authority Group

This is used to store the settings relevant to user authorities in advance for each group. The authority of each user is specified by selecting one of these registered groups when the user is registered.

- [Add] key
Use this to add a new group.
- List
This shows the currently stored groups. Selecting a group name displays the edit screen for that group.

Storing authority groups

When you tap the [Add] key, the registration screen appears. Up to 20 groups can be registered. For detailed information about each of the settings, see the following table.

Editing an authority group

Selecting a group from the list displays the edit screen for that group. For detailed information about each of the settings, see the following table.

To return a group to the factory default state, select the group from the list and select any of options [Return to the Administrator Authority], [Return to the system administrator authority.], [Return to the User Authority], [Return to the Guest Authority], [Return to the Colour prohibited authority.] and [Return to the scanner prohibited authority.].

Tapping the [Execute] key resets the group status to the factory default.

Item	Description					
Group Name	Store a name of group (up to 32 characters).					
Select the Group Name to be the Registration Model	Select one of the previously stored groups for use as a template for the new group. When selected, the settings of this group are applied.					
	The factory default groups and their settings are shown below.					
	Admin	System Administrator	User	Guest	Colour Prohibited Authority	Scanner Prohibited Authority
Copy						
Colour Mode Approval Setting	All allowed	All prohibited	All allowed	Only Black & White Allowed	Only Black & White Allowed	All allowed
Special Modes Usage	Allowed	Prohibited	Allowed	Prohibited	Prohibited	Allowed
Sending while copying	Allowed	Allowed	Allowed	Allowed	Allowed	Allowed
Approval Setting to Use Toner Save Mode	No Toner Save	No Toner Save	No Toner Save	No Toner Save	No Toner Save	No Toner Save
Creation of PDF for PC Browsing	Allowed	Prohibited	Allowed	Allowed	Allowed	Allowed
Printer						
Colour Mode Approval Setting	Allowed	All prohibited	Allowed	Only Black & White Allowed	Only Black & White Allowed	All allowed
FTP Pull Print	Allowed	Prohibited	Allowed	Prohibited	Prohibited	Allowed
USB Memory Direct Print	Allowed	Prohibited	Allowed	Prohibited	Prohibited	Allowed
Network Folder Pull Print	Allowed	Prohibited	Allowed	Prohibited	Prohibited	Allowed
Sending while printing	Allowed	Allowed	Allowed	Allowed	Allowed	Allowed



Item	Description					
Creation of PDF for PC Browsing	Allowed	Prohibited	Allowed	Allowed	Allowed	Allowed
Approval Setting to Use Toner Save Mode	No Toner Save	No Toner Save	No Toner Save	No Toner Save	No Toner Save	No Toner Save
Image Send						
Approval Settings for Each Mode						
<ul style="list-style-type: none"> • E-mail • FTP • Desktop • Network Folder • Scan to Ext.Memory Dev. • Internet Fax Send • PC-I-Fax Send • Fax Send • PC-Fax Send • PC Scan 	All allowed	All prohibited	All allowed	All allowed	All allowed	All prohibited
Colour Scan	Allowed	Prohibited	Allowed	Prohibited	Prohibited	Allowed
Special Modes Usage	Allowed	Prohibited	Allowed	Prohibited	Prohibited	Allowed
Registration/Deletion of Program	Allowed	Prohibited	Allowed	Prohibited	Prohibited	Allowed
Creation of PDF for PC Browsing	Allowed	Prohibited	Allowed	Allowed	Allowed	Allowed
Access to Fax Data	Allowed	Allowed	Allowed	Allowed	Allowed	Allowed
Approval Setting for Addressing						
<ul style="list-style-type: none"> • Approval Setting for Direct Entry • Approval Setting to Use a Local Address Book • Approval Settings to Use a Global Address Book 	All allowed	All allowed	All allowed	All allowed	All allowed	All allowed
Document Filing						
Scan to HDD						
Colour Scan	Allowed	Prohibited	Allowed	Only Black & White Allowed	Only Black & White Allowed	Allowed
Special Modes Usage	Allowed	Prohibited	Allowed	Prohibited	Prohibited	Allowed
Creating Downloadable File	Allowed	Prohibited	Allowed	Allowed	Allowed	Allowed
Prints (Document Filing)						
Colour Mode Approval Setting	All allowed	All prohibited	All allowed	Allowed	Allowed	All allowed
Special Modes Usage	Allowed	Prohibited	Allowed	Prohibited	Prohibited	Allowed
Document Filing Image Check						
Approval Setting	Allowed	Prohibited	Allowed	Prohibited	Prohibited	Allowed



Item	Description					
Display only the Files of Logged-in Users	Prohibited	Prohibited	Prohibited	Prohibited	Prohibited	Prohibited
SharpOSA						
Approval Setting to Use a Sharp OSA	Allowed	Prohibited	Allowed	Allowed	Allowed	Allowed
Common Functions						
Approval Settings for 2-Sided Print	All allowed	All allowed	All allowed	All allowed	All allowed	All allowed
Change Billing Code	Allowed	Allowed	Allowed	Allowed	Allowed	Allowed
Output Approval Settings	All allowed	All prohibited	All allowed	All prohibited	All prohibited	All allowed
Security						
Document Filing Approval Setting: Quick File/ Sharing Mode	Prohibited	Prohibited	Prohibited	Prohibited	Prohibited	Prohibited
Document Filing Approval Setting: Confidential Mode	Allowed	Prohibited	Allowed	Prohibited	Prohibited	Allowed
Print Jobs Other than Print Hold Job	Allowed	Allowed	Allowed	Allowed	Allowed	Allowed
Hidden Pattern Print Setting - Direct Entry	Allowed	Prohibited	Allowed	Prohibited	Prohibited	Allowed
Machine Settings						
Machine Settings						
Total Count	Allowed	Allowed	Allowed	Prohibited	Allowed	Allowed
Device / Network Status	Allowed	Allowed	Allowed	Prohibited	Allowed	Allowed
Power Reset	Allowed	Allowed	Prohibited	Prohibited	Prohibited	Prohibited
List for User	Allowed	Allowed	Allowed	Prohibited	Allowed	Allowed
List for Administrator	Allowed	Allowed	Prohibited	Prohibited	Prohibited	Prohibited
Address Registration	Allowed	Allowed	Allowed	Prohibited	Allowed	Allowed
Document Filing Folder Registration	Allowed	Allowed	Allowed	Prohibited	Allowed	Allowed
User Control (Admin)	Allowed	Allowed	Prohibited	Prohibited	Prohibited	Prohibited
User Control (User)	Allowed	Allowed	Allowed	Prohibited	Allowed	Allowed
Home Screen Settings	Allowed	Allowed	Prohibited	Prohibited	Prohibited	Prohibited
Copy Function Settings	Allowed	Allowed	Prohibited	Prohibited	Prohibited	Prohibited
Printer Settings (Admin)	Allowed	Allowed	Prohibited	Prohibited	Prohibited	Prohibited
Printer Settings (User)	Allowed	Allowed	Allowed	Prohibited	Allowed	Allowed
Image Send Settings > Common Settings	Allowed	Allowed	Prohibited	Prohibited	Prohibited	Prohibited
Scan Settings	Allowed	Allowed	Prohibited	Prohibited	Prohibited	Prohibited



Item	Description					
Fax Settings	Allowed	Allowed	Prohibited	Prohibited	Prohibited	Prohibited
I-Fax Settings	Allowed	Allowed	Prohibited	Prohibited	Prohibited	Prohibited
Fax Data Receive/Forward (Manual)	Allowed	Allowed	Allowed	Prohibited	Allowed	Allowed
Inbound Routing (Forwarding/Storing) Settings (Admin)	Allowed	Allowed	Prohibited	Prohibited	Prohibited	Prohibited
Inbound Routing (Forwarding/Storing) Settings (User)	Allowed	Allowed	Allowed	Prohibited	Allowed	Allowed
Metadata Entry	Allowed	Allowed	Prohibited	Prohibited	Prohibited	Prohibited
Document Filing Settings	Allowed*	Allowed*	Prohibited	Prohibited	Prohibited	Prohibited
Sharp OSA Settings	Allowed	Allowed	Prohibited	Prohibited	Prohibited	Prohibited
Paper Settings (Bypass Tray Excluded)	Allowed	Allowed	Allowed	Prohibited	Allowed	Allowed
Paper Settings (Bypass Tray)	Allowed	Allowed	Allowed	Prohibited	Allowed	Allowed
Operation Settings	Allowed	Allowed	Prohibited	Prohibited	Prohibited	Prohibited
Keyboard Settings	Allowed	Allowed	Prohibited	Prohibited	Prohibited	Prohibited
Device Control	Allowed	Allowed	Prohibited	Prohibited	Prohibited	Prohibited
Machine Identification Settings	Allowed	Allowed	Prohibited	Prohibited	Prohibited	Prohibited
Clock	Allowed	Allowed	Prohibited	Prohibited	Prohibited	Prohibited
Product Key	Allowed	Allowed	Prohibited	Prohibited	Prohibited	Prohibited
Custom Link Setting	Allowed	Allowed	Prohibited	Prohibited	Prohibited	Prohibited
Network Settings	Allowed	Allowed	Prohibited	Prohibited	Prohibited	Prohibited
Security Settings	Allowed	Allowed	Prohibited	Prohibited	Prohibited	Prohibited
Energy Save	Allowed	Allowed	Prohibited	Prohibited	Prohibited	Prohibited
System Control	Allowed	Allowed	Prohibited	Prohibited	Prohibited	Prohibited
Image Quality Adjustment	Allowed	Allowed	Prohibited	Prohibited	Prohibited	Prohibited
Operation Manual Download	Allowed	Allowed	Allowed	Allowed	Allowed	Allowed
Shortcut Page Setting	Allowed	Allowed	Prohibited	Prohibited	Prohibited	Prohibited

* For information on each setting, see the setting mode list.



Depending on the machine specifications and peripheral devices installed, it may not be possible to use some settings.



Favourite Operation Group

Favourite Operation Group List

The preferred operation environment can be set for each group. For example, a user who speaks a different language would normally have to change the display language each time he or she uses the machine; however, by registering the language in a favourite operation group in advance, the language is automatically selected when the user logs in.



- Depending on the machine specifications and peripheral devices installed, it may not be possible to use some settings.
- This setting can only be configured in Setting mode (Web version). It cannot be configured in the touch panel of the machine.

Adding/editing a group

Tap the [Add] key to display the favourite operation group registration screen.

Tap a group name to display the registration screen for that favourite operation group. You can edit the group in this screen.

Settings

Item	Description
Group Name	Store a name of group (up to 32 characters).
Select the Group Name to be the Registration Model	Select one of the previously stored groups for use as a template for the new group. When selected, the settings of this group are applied.
Copy	
Initial Status Settings	Select settings for colour mode, Image Orientation, Paper Tray, Exposure Type, Copy Ratio, 2-Sided, Original Binding, Output Binding, Output, Offset, Output Tray, Separator Page, Staple Sort, Staple Position, Punch, and Fold.
Image Send	
Initial Status Settings	Select settings for Image Orientation, Exposure, Resolution, Colour Mode, File Format, and Original Image Type. Select settings for Specified Pages per File, and Fax Sender Name.
Document Filing	
Image Orientation	Specify the image orientation.
Initial Status Settings	Select settings for Colour Mode, Exposure, Original Image Type, and Resolution.
Prints (Document Filing)	Set the default output tray for document filing print.
System Settings	
Enlarge Display Mode	Turn this option ON to display large characters on the Setting mode screen.
Original Size Detector Setting	Select whether Inch sizes or AB sizes are detected, or disable detection on the document glass.
Cancel Detection at Document Glass	Original size detection on the document glass can be disabled. When this is done, all originals placed on the document glass are treated as special size originals.
Language Setting	Select the display language.
Switch the Number of Sets to be Displayed for Job Status	Select whether to display the number of progress sets or remaining sets as the job status.
Key Operation Setting	Set the key input time and Auto Key Repeat setting.
Time for Accepting Key Entry of Long Touch	Select a time when a long key touch is detected.
Double Tap Interval Setting	Select an interval when a double tap is detected.



Item	Description
Keys Touch Sound	Set the sound made when keys are touched.
Keyboard Select	Set the language that appears on the keyboard.
MFP Display Pattern Setting	Select the colour pattern used in the touch panel.
Automatically print stored jobs after login	When retention is enabled in the printer driver and print data has been spooled to the machine, the spooled print data is automatically printed out when the user who enabled retention logs in.
Favorite Key Setting	Select to use System Settings or use the registered Favourite key settings for performing Favourite Key Setting.
Home Screen Settings	Select to use System Settings or use the stored home screen settings for performing Home Screen Settings.
Preview Setting: Default List/Thumbnail Display	
Fax/I-Fax Reception Data	Select whether the default display format of the received fax/I-Fax list screen is list or thumbnails.
File Retrieve of Main Folder/Quick File Folder	Select whether the default display format of the document filing main folder and temporary folder screens is list or thumbnails.
File Retrieve of Custom Folder	Select whether the default display format of the document filing custom folder screen is list or thumbnails.
File Retrieve of Direct Print	Select whether the default state of the file list screen for direct print shows the folders as a list or as thumbnails.

Returning a favourite operation group to "Unlimited"

To return a selected favourite operation group to the factory default state, select the checkbox () to the left of "No." and tap the [Return to the Defaults] key.

Favorite Key List

Assign shortcut keys to frequently used functions.
They will be displayed in the base screen of each mode.

Settings

Item	Description
Key Name	Enter a maximum of 20 characters for the favourite key name. (Up to 20 full-width characters can be entered, but only 10 will be shown on the key.)
Function Menu/Program/ Others	Select the function that you wish to assign to the favourite key. The functions that can be selected vary by mode.
No Display	Enable this setting to not show favourite keys.



Home Screen List

Home screen settings must be previously stored. Select a home screen when registering Favourite Operation Group List.

Item	Description
Name	Enter a maximum of 32 characters for the home screen name.
Select the Group Name to be the Registration Model	Select one of the previously stored home screens as a template for the new home screen. When selected, the settings of this home screen are applied.
Change Home Screen Name	Enter a home screen name to change the existing name.
Template	Select a layout pattern of the registered key.
Key Layout of the Screen	The layout of the keys in the home screen is displayed.
Change Text Colour On Home Screen	Set the colour of the text in the scroll area, fixed area, and clock.
Home Button	Registers the function to use for the selected key number.
Fix Key	Registers the function to use for the selected key number. This button is displayed on all pages of the home screen.
Display Toner Quantity	Select this to display the toner level in the fixed area.

User Count

This displays the total number of pages printed by each user.

- [Select All] key
This selects all users.
- [Clear Checked] key
This clears all selections.
- [Show] key
This shows the counts of the selected user.
- [Clear Count] key
Use this to reset the counts of the selected user.
- User List
This shows the users stored as factory default and the currently stored users. When you select a user name, the user is selected.

View User Count

When you select a user and tap the [Show] key, this user count is displayed.

Item	Description
Next	Displays the next user (in the order of the registration numbers).
Previous	Displays the previous user (in the order of the registration numbers).
Show Counts	Displays the counts and the number of pages remaining of the selected user for each function.
Page Limit	The page limit set for the user appears in parentheses below the count.



If peripheral devices are not mounted, their count is not displayed.



Resetting user counts

Select a user in the setting screen and tap the [Clear Count] key. A count reset screen for that user will appear. The reset screen will vary depending on whether a single user or multiple users were selected. The items displayed in each case are described in the table below.

When a single user is selected

Item	Description
Next	Displays the next user (in the order of the registration numbers).
Previous	Displays the previous user (in the order of the registration numbers).
Show Counts	Displays the counts and the number of pages remaining of the selected user for each function.
Clear Count	Reset the count of the selected item to "0".
Clear All Count	Clears all counts of the selected user to zero (0).

When multiple users are selected

Item	Description
Show Counts	Displays the counts and the number of pages remaining of the selected user for each function.
Clear Count	Reset the count of the selected item to "0".
Clear All Count	Clears all counts of the selected user to zero (0).

Save User Count

Clicking the [Save] button saves the user count information as a data file.

To delete the user count information in the machine, click the checkbox next to the "Save and Delete the Data" so that it is selected and click the [Save] button.



This setting can only be configured in Setting mode (Web version). It cannot be configured in the touch panel of the machine.



Billing Code Setting

Administration Settings

Change the billing code setting.

Use Billing Code

Switch whether to enable or disable a billing code.

Default Code Setting

A use code is automatically assigned when no billing code is entered. Specify the code using up to 32 single-byte characters.

Remember Billing Code Between Modes

If this function is enabled, the billing code entry window is not displayed at the time of mode transition.

Disable Change of Billing Code

If this function is enabled, you cannot register, edit, or delete a billing code. In addition, you cannot directly type in a billing code in the billing code entry window.

Apply Default Code when Billing Code not entered Billing Code not Entered

If this function is enabled, a use code is always set while you are logging in with device account.

Disable Billing Code for Selected Applications

The billing code entry window is displayed when the external application that is set to enable is started. The following settings can be configured.

- Application Name registered as Standard Application

Billing Code Display Name Setting

You can change the main code or sub code name displayed in the billing code entry window or billing code selection window.

Main Code List

You can display a list of main codes to search for, register, correct, or delete a main code.

- [Search] key
Searches for a main code.
- [Add] key
Adds a new main code.
- List
Displays a list of registered main codes. Selecting each main code displays the window to correct the main code.
- [Delete] key
Set the check box on the left of each main code to , then tap the [Delete] key; the selected main code is deleted.

Register a main code

When you tap the [Add] key, the registration screen appears. A total of up to 2,000 main and sub codes can be registered.

For information on the settings, see "[Settings \(page 7-78\)](#)".

After the setting has been completed, tap the [Submit and Register Next] key; you can continuously register the next main code. To end the registration process, tap the [Submit] key.

Correct a main code

Selecting a main code from the list displays the window to correct the main code.

For information on the settings, see "[Settings \(page 7-78\)](#)".

After the setting has been completed, tap the [Submit] key; you can apply the corrected contents and complete processing.



Search for a main code

Enter the main code and main code name, then tap the [Search] key; the search result is displayed.

Settings

Item	Description
Main Code	Enter the main code. Specify the code using up to 32 single-byte characters.
Main Code Name	Enter the main code. Specify the code name using up to 32 double- or single-byte characters.
Available to	The registered billing codes can only be shared in the specified group. When not specifying a public destination, select [All Users]. When specifying a public destination, select [Designate Public Address.], then specify a group to share the billing code.



To register a group for specifying a public destination

In "Settings (administrator)", select [User Control] → [Organization /Group List].

Sub Code List

You can display a list of sub codes to search for, register, correct, or delete a sub code.

- [Search] key
Searches for a sub code.
- [Add] key
Adds a new sub code.
- List
Displays a list of registered sub codes. Selecting each sub code displays the window to correct the sub code.
- [Delete] key
Set the check box on the left of each sub code to , then tap the [Delete] key; the selected sub code is deleted.

Register a sub code

When you tap the [Add] key, the registration screen appears. A total of up to 2,000 main and sub codes can be registered.

For information on the settings, see "[Settings \(page 7-79\)](#)".

After the setting has been completed, tap the [Next] key; you can continuously register the next sub code. To end the registration process, tap the [Submit] key.

Correct a sub code

Selecting a sub code from the list displays the window to correct the sub code.

For information on the settings, see "[Settings \(page 7-79\)](#)".

After the setting has been completed, tap the [Submit] key; you can apply the corrected contents and complete processing.



Search for a sub code

Enter the sub code and sub code name, then tap the [Search] key; the search result is displayed.

Settings

Item	Description
Sub Code	Enter the sub code. Specify the code using up to 32 single-byte characters.
Sub Code Name	Enter the sub code. Specify the code name using up to 32 double- or single-byte characters.
Available to	The registered billing codes can only be shared in the specified group. When not specifying a public destination, select [All Users]. When specifying a public destination, select [Designate Public Address.], then specify a group to share the billing code.



To register a group for specifying a public destination

In "Settings (administrator)", select [User Control] → [Organization /Group List].

Card Setting

Card Area Setting

The data check during card reading can be set.

Settings

Item	Description
Check System Code only in FeliCa User Area mode	Check the System Code only in FeliCa User Area mode.
Check Facility Code in HID mode	Checks the facility code of a HID card.
Facility Code	Enters the facility code of a HID card. When you tap the [Store] key, the facility code is stored.
Importing from the setup file	When you enter the configuration file name and tap the [Execute] key, the card area settings are read from the configuration file. If you tap the [Clear] key, all files that match the current search conditions are deleted.

Card Type / Card Reader Settings

Use these settings for authentication and for use of a HID or other IC card.

Settings

Item	Description
Card Type / Card Reader	Enter the card type and card reader information.



SYSTEM SETTINGS

Home Screen Settings

You can change the layout, icons, and background of the machine's home screen.

Condition Settings

Item	Description
Template	You can change the layout of the keys by selecting a pattern saved in advance. The [Key Layout of the Screen] image changes as you make selections.
Change Text Colour On Home Screen	Set the colour of the text in the scroll area, fixed area, and clock.
Home Screen List	The order of arrangement of the shortcut keys in the home screen is indicated by the "No.", and the displayed keys appear in the home button column. To edit the home buttons, click the Home Button item.
Fixed area list	Set the keys (fixed keys) that appear in the fixed area below the home buttons. The order of arrangement of the keys is indicated by the "No.", and the keys appear in the fixed key column. To edit the fixed keys, click the Fix Key item.
Display Toner Quantity	Select this to display the toner level in the fixed area.

Icon

Use this setting to register a key icon.

Item	Description
Icon list	Use this setting to register icons for home screen shortcut keys. The image files of shortcut key icons are registered in a list. To register an image, click an image file registered in "Name" or "Not Set". The icon registration screen appears. Register the desired image. Image formats that can be registered are JPEG, GIF, PNG (jpeg, jpg, jpe, jfif, gif, png). The maximum image file size that can be registered is 50 KB.



To configure this setting on the machine, insert the USB memory device that contains the image into the machine.



Background Image

Use this setting to register a background image.

Item	Description
Background image list	Image files such as a background images are registered in the registered image list. To register an image, click a name with a registered image or an unused name. The background image registration screen will appear. Register the desired image. The formats of images that can be registered are JPEG, GIF, and PNG (jpeg, jpg, jpe, jfif, gif, png). The maximum file size for a background image is 640 MB.



To configure this setting on the machine, insert the USB memory device that contains the image into the machine.

Home Screen Registration

You can click a home button in the home screen list to change the settings of the home button.

Select the function that you want to assign to the button. If you select [None], a home button will no longer appear in that location. To register a key name, select [Custom] and enter the name (maximum 28 characters).

To change the image of a home button, register the desired icon in advance using [Icon], and then select the image with [Select File].



Copy Settings

Condition Settings

The following settings are related to copying.

Default settings selected with these settings apply to all functions of the machine (not just the copy function).

Rotation Copy Setting

When the original and paper are placed in different orientations, this function automatically rotates the image 90 degrees to enable correct copying on the paper.



Enable the Rotation Copy setting to copy an A5 (5-1/2" x 8-1/2") size original on A5R (5-1/2" x 8-1/2"R) paper.

Add or Change Extra Preset Ratios

Add two enlargement preset ratio values (101% to 400%) and two reduction preset ratio values (25% to 99%). Also, you can change the preset ratio if necessary.



Preset ratios other than added preset ratios cannot be changed.

Setting a Maximum Number of Copies

This is used to set the maximum number that can be entered for the number of copies (number of continuous copies). Any number from 1 to 9999 can be specified.

Initial Margin Shift Setting

This is used to set the default margin shift amount. Specify a value from 0 mm (0") to 50 mm (2") in increments of 1 mm (1/8") for both the front and reverse sides.

Erase Width Adjustment

This is used to set the default erase width for erase function. Specify a value from 0 mm (0") to 20 mm (1") in increments of 1 mm (1/8") for both edge erase and centre erase.

InitialN-Up Setting

Set the default state for N-Up. Select the page layout for N-Up, whether or not borders are added, and if added, whether the borders are solid lines or dotted lines.

Card Shot Settings

This is used to set the default original size for the card shot function.

Specify a value from 25 mm (1") to 210 mm (8-1/2") in increments of 1 mm (1/8") for both the X (horizontal) and Y (vertical) dimensions of the original.

Fit to Page

Enable this setting to have the [Fit to Page] key always appear in the card shot screen.



Initial Tab Copy Setting

This is used to set the default image shift width (tab width) for tab copying. Specify a value from 0 mm (0") to 20 mm (1") in increments of 1 mm (1/8").

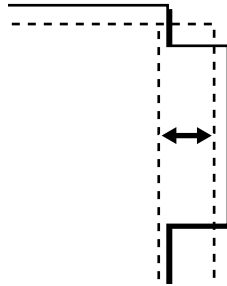

Disabling of Registration/Deletion of Program

This is used to prohibit the deletion and change of copy settings stored in job programs.

Disabling of Bypass-Tray in Duplex Copy

Disables the use of the bypass tray when making 2-sided copies.

The bypass tray is often used to feed label sheets, transparency film, and other special media for which 2-sided copying is prohibited. If a sheet of one of these special media enters the reversing unit, a misfeed or damage to the unit may result. If special media for which 2-sided copying is prohibited is often used, it is recommended that you enable this setting.

Disabling of Auto Paper Selection

Disables the Auto Paper Selection function.

When this setting is enabled, automatic selection of paper that is the same size as the original on the document glass or in the automatic document feeder does not take place.

Auto Selection Setting of Tray that is Supplied the Paper

When this setting is enabled and paper is loaded into a tray while the machine is on standby in copy mode, that tray is automatically selected.

Disabling Registration of Custom Image

Disables storage of a custom image.

Disabling sending while copying

Disables the Image Send function during copy.



High Quality Scan from Document Feeder (B/W)

The resolution for copying in black and white using the automatic document feeder can be changed from 600 x 400 dpi to 600 x 600 dpi (high quality mode).

When high quality mode is used, fine print and thin lines are reproduced with greater clarity, however, the scanning speed is slower.



When high quality mode is not selected, the following conditions must be satisfied in order to scan at 600 x 400 dpi and attain the fastest speed.

- The copy ratio must be set to 100%.
- Do not select a special mode that will change the ratio.
- [Copy of Copy] must not be enabled.
- Do not copy in black and white with the [Colour Start] key.

Quick Scan from Document Glass (B/W)

The resolution for copying in black and white using the document glass can be changed from 600 x 600 dpi to 600 x 400 dpi (high speed mode).

When high speed mode is selected, the first copy time is quicker, however, the copy image is not as clear.



When high quality mode is not selected, the following conditions must be satisfied in order to scan at 600 x 400 dpi and attain the fastest speed.

- The copy ratio must be set to 100%.
- Do not select a special mode that will change the ratio.
- [Copy of Copy] must not be enabled.
- Do not copy in black and white with the [Colour Start] key.

Auto Clear Before Copy Execution Also

Enables the Auto Clear function during copy even when a copy job is not completed. This protects the machine from being held due to the incomplete copy job.



Initial Status Settings

The following settings are related to copying.

Initial Status Settings selected with these settings apply to all functions of the machine (not just the copy function).

The copier settings are reset to the initial state when the [Power] button is turned on, when the [CA] key is tapped, or when the auto clear interval has elapsed. These settings are used to change the default settings for copy mode.

The following settings can be changed:

Item	Description
Colour Mode	Configure default colour mode settings.
Image Orientation	Specify the original orientation.
Paper Tray	Specify the paper tray that is selected by default.
Exposure Type	Configure default exposure mode settings.
Copy Ratio	Specify the copy ratio that is selected by default.
2-Sided Copy	Configure the 2-sided mode settings that are selected by default. If this setting is used to change the default setting for the duplex function to any setting other than "1-Side to 1-Side" and the duplex function or automatic document feeder fails or is disabled, the setting will revert to "1-Side to 1-Side".
Original Binding	Set the original binding in 2-Sided copy.
Output Binding	Set the output binding in 2-Sided copy.
Output	Set the print output method and output tray that are selected by default.
Output Tray	Specify the output tray.
Staple	Configure staple settings
Offset	Set whether or not offset is performed in the default settings.
Separator Page	Separator pages can be inserted before or after jobs. Set the paper tray used for the separator pages.
Punch	Configure punch settings
Factory defaults	This returns all items to the factory default settings.

Text /Image Printing

Text Settings (Stamp)

You can add fixed text used in the [Stamp] in [Others] of copying.

Custom Stamp

You can set an image to be used in [Custom Stamp] in [Custom Image] of [Others] for copying.

Custom Watermark

You can set an image to be used in [Custom Watermark] in [Custom Image] of [Others] for copying.



Printer Settings

Settings related to the printer function can be configured.

Condition Settings

Printer condition settings are described below.

Prohibit Notice Page Printing

Disables to print a notice page.

Prohibit Test Page Printing

Disables to print the test page.

When this setting is enabled, [Status] → [Data List] → [List for User] → [Printer Test Page] in "Settings" cannot be used to print test pages.

A4/Letter Size Auto Change

When printing an A4 (8-1/2" x 11") size image, this setting allows 8-1/2" x 11" (A4) size paper to be used if A4 (8-1/2" x 11") size paper is not loaded.

Bypass Tray Settings

Enable Detected Paper Size in Bypass Tray

This is used to prohibit printing when the paper size specified for a print job is different from the paper size inserted in the bypass tray.

Enable Selected Paper Type in Bypass Tray

This is used to prohibit printing when the paper size specified for a print job is different from the paper size inserted in the bypass tray.

Exclude Bypass-Tray from Auto Paper Select

When [Auto] is selected for paper type selection, the bypass tray is excluded from the trays that can be selected. This is recommended when special paper is often placed in the bypass tray.

Job Spool Queuing

When this function is enabled, received print jobs are displayed in the spool queue of the job status screen. The jobs are moved to the job queue after they have been analyzed by the machine.

Multiple jobs that have not yet been analyzed appear in the spool queue.

When this function is disabled, received print jobs are displayed in the job queue instead of being displayed in the spool queue. However, when an encrypted PDF job is printed, the job appears in the spool queue.

Disabling of USB Memory Direct Print

Disables the function for directly printing of a file in a USB memory device.

Disabling of Network Folder Direct Print

Disables the direct printing from a network folder.

Disabling sending while printing

Disables the Image Send function during printing.



Initial Status Settings

If you print data in an environment where the printer driver is not used (that is, if you print data using the MS-DOS system or if you print data using the PC that does not have the provided printer driver installed), set the detailed printing conditions. (However, the "Disable Blank Page Print" function will be effective even when the PCL printer driver is used.)

Settings

Setup Items	Description
Copies	1 - 9999 sets
Orientation	<ul style="list-style-type: none"> • Portrait • Landscape
Paper Size	Set the default paper size.
Output Tray	Set the default delivery tray.
Paper Type	Set the default paper type.
Resolution Setting	<ul style="list-style-type: none"> • 600dpi • 600dpi (High Quality) • 1200dpi*¹
Disable Blank Page Print	<ul style="list-style-type: none"> • <input checked="" type="checkbox"/> (Enabled) • <input type="checkbox"/> (Disabled)
2-Sided Print	<ul style="list-style-type: none"> • 1-Sided • 2-Sided(Book) • 2-Sided(Tablet)
Colour Mode	<ul style="list-style-type: none"> • Auto • Black & White
N-Up Print* ²	N-Up <ul style="list-style-type: none"> • 1-Up • 2-Up • 4-Up • 8-Up
	Layout <ul style="list-style-type: none"> • Left to Right*³ • Right to Left*³ • Right, and Down*⁴ • Down, and Right*⁴ • Left, and Down*⁴ • Down, and Left*⁴
Fit To Page* ⁵	<ul style="list-style-type: none"> • <input checked="" type="checkbox"/> (Use Fit to Page) • <input type="checkbox"/> (Do not use Fit to Page)
Output	<ul style="list-style-type: none"> • <input checked="" type="checkbox"/> (Use Print per Unit) • <input type="checkbox"/> (Do not use Print per Unit) • Staple Position*⁶: None, 1 Staple at Back, 2 Staples, 2 Staples (Top) • <input type="checkbox"/> (Use Punch)*⁷ • <input checked="" type="checkbox"/> (Do not use Punch)*⁷
Separator Page	<ul style="list-style-type: none"> • <input type="checkbox"/> Insert Before Job Paper Tray • <input type="checkbox"/> Insert After Job Paper Tray



Setup Items	Description
Quick File	<ul style="list-style-type: none"> <input type="checkbox"/> (Disabled) <input checked="" type="checkbox"/> (Enabled)

*1 This item cannot be used in MX-2630N/MX-3050V/MX-3550V/MX-4050V/MX-5050V/MX-6050V.

*2 Paper sizes that can be used with this function are A3, B4, A4, 11" x 17", 8-1/2" x 14", and 8-1/2" x 11". (This function may not take effect with some print methods.)

*3 Can be selected when 2-Up is selected.

*4 Can be selected when 4-Up/8-Up is selected.

*5 Only effective when printing PDF, JPEG, and TIFF files.

*6 When the finisher is installed.

*7 When a punch module is installed.

PCL Settings

This is used to set the symbol sets, fonts, and line feed code used in a PCL environment.

Settings

Setup Items	Settings	Setting
PCL Symbol Set Setting	Specify the symbol set used for printing.	<ul style="list-style-type: none"> Select from 35 items.
PCL Font Setting	Select a font used for printing.	<ul style="list-style-type: none"> Internal Font Extended Font (List of internal fonts when extended fonts are not installed.)
PCL Line Feed Code	This setting is used to select how the printer responds when a line feed command is received.	<ul style="list-style-type: none"> 0.CR=CR; LF=LF; FF=FF 1.CR=CR+LF; LF=LF; FF=FF 2.CR=CR; LF=CR+LF; FF=CR+FF 3.CR=CR+LF; LF=CR+LF; FF=CR+FF
Wide A4	When this is enabled, 80 characters per line are printed on the A4 (8-1/2" x 11") size paper using a 10-pitch font. (When this setting is disabled, up to 78 characters are printed per line.)	<ul style="list-style-type: none"> (Enabled) <input checked="" type="checkbox"/> (Disabled) <input type="checkbox"/>



PostScript Settings

When an error occurs during PostScript printing, these settings determine whether or not an error notice is printed and whether or not the PostScript data is received in binary format. On the MX-2630N/MX-3050V/MX-3550V/MX-4050V/MX-5050V/MX-6050V, this can only be enabled when the PS3 expansion kit is installed.

Setup Items	Settings	Setting
Screen Settings	Configure image settings for PostScript.	Standard, Text/Photo, Text, Photo, Dot (High Line Number), Dot (Low Line Number)
Print PS Errors	When a PS (PostScript) error occurs during PostScript printing, this setting determines whether or not an error notice is printed.	(Enabled) <input checked="" type="checkbox"/> (Disabled) <input type="checkbox"/>
Binary Processing	Configure image settings for PostScript.	(Enabled) <input checked="" type="checkbox"/> (Disabled) <input type="checkbox"/>

OOXML Settings

To print an Excel file by direct print, select a sheet (with the part to be printed selected) or the entire book. On the MX-2630N/MX-3050V/MX-3550V/MX-4050V/MX-5050V/MX-6050V, the Direct print expansion kit is required.

Print Release Settings

Select this option to use the E-mail printing. For detailed information, see "Print Release Settings Guide".



E-mail Print Settings

Select this option to use the E-mail printing.

E-mail Print

Set whether or not E-mail print is performed.

POP3 Server

Set the POP3 server used for E-mail.

Port Number

Set the port number of the E-mail server.

POP Authentication

Set this to perform POP authentication for E-mail.

User Name

Set the E-mail user name.

Password

Set the password used for E-mail.

Check Interval

Set the automatic e-mail check frequency (polling interval).

Enable SSL

Use when SSL is used.

Direct Print Settings (FTP)

Configure these settings if you will be printing files on an FTP server by direct print.

A list of available FTP servers is shown. To add an FTP server, click the [Add] button and configure the settings.

FTP Server Registration

Configure FTP server settings.

Name

Set the name to be used for direct print.

FTP Server

Set the name of the FTP server.

Directory

Set the directory of the FTP server that has the files.

User Name

Set the user name used to log in to the FTP server.

Password

Set the password used to log in to the FTP server.

Enable SSL

Set to enable SSL.

Use PASV mode

Set to use PASV mode.



Direct Print Settings (Network Folder)

Configure these settings if you will be printing files on a network folder by direct print.

A list of available network folders is shown. To add a network folder, click the [Add] button and configure the settings.

Registration of Network Folder

Configure network folder settings.

Name

Set the name to be used for direct print.

Folder Path

Set the folder path that has the files.

User Name

Set the user name used to log in to the network folder.

Password

Set the password used to log in to the network folder.

Print Setting from PC/Mobile Terminal

Configure these settings to print files on a computer or mobile terminal by direct print.

FTP Print

Specify whether or not FTP print settings are used for direct print.

Port Number

Enter the port number used for direct print.

Use Banner

Specify whether or not a banner page showing print information is also printed.



Image Send Settings

Common Settings

Settings related to the image send function (E-mail, Internet fax, etc.) can be configured.



For an explanation of settings related to the fax function, see "[Image Send Settings \(page 7-180\)](#)"

The operation settings below apply to all image send functions.

Condition Settings

Hold settings for a while after scanning has been completed

Use this setting to hold the settings after scanning is completed (until Auto Clear Mode activates).

Job Auto Start Time During Scanning

Set the time at which transmission is automatically started even if the original is still being scanned.

Default Display Setting

When resending by document filing or recalling by saved program settings that do not include an address, select from the following 6 types of base screens that appear.

- E-Mail
- Network Folder
- FTP/Desktop
- Internet Fax
- Fax
- Data Entry

Address Book Default Selection

Higher priority is given to the display of address book.

If image send mode is enabled, the Address Book is displayed in place of the initial screen of this mode.



In "Settings", if a default address has been configured by selecting [System Settings] → [Image Send Settings] → [Scan Settings] → [Default Address] → [Default Address Setting], the [Higher priority is given to the display of address book.] function cannot be used.

Apply Addresses of Sending Modes Only

When an address is selected from the address book, only the addresses displayed in narrowing mode are applied.

Category Displayed as Default

Select a category to be displayed with the default.

- None
- Frequent Use
- Categories 1 to 32

Display all address type regardless of the mode being displayed currently.

Displays all destinations regardless of the displayed mode when this setting is enabled.

Enlarge Address Book

An enlarged address book list appears.

Image Orientation

Sets the default image orientation.



Preview Setting

Received Data Image Check Setting

Select whether or not a preview of received faxes and Internet faxes is shown.

This is displayed when a facsimile expansion kit or Internet fax expansion kit is installed.

Default List/Thumbnail Display

Fax/I-Fax Reception Data: Select whether the default display format of the received fax/I-Fax list screen is list or thumbnails.

Default Exposure Settings

This is used to set the default exposure settings for scanning a document in image send mode. Select [Auto] or [Manual]. If you select [Manual], set the exposure to one of 5 levels.



When the exposure is set to [Auto], a default original type cannot be selected.

Default Original Image Type

Select the original type beforehand to enable scanning at a resolution suitable for the original (only in scan mode and USB memory device scan mode).

The following settings can be configured.

- Text/Printed Photo
- Text/Photo
- Text
- Photo
- Printed Photo
- Map

Sending the same image sent in Fax mode

This is used to enable or disable the default setting. Enable this when sending by broadcast transmission in Fax and other modes and you want to send the same image in all modes. If this function is disabled, an image specified with each Scan Setting is sent to E-mail, FTP, Desktop, and Network Folder. When an Internet Fax address is included in the addresses, the same image is sent regardless of this setting.

Be sure to press Next Address Key ([+]) before selecting the next address.

Set whether or not the Next Address ([+]) key must be pressed before an address is added for a multi-address job such as broadcast transmission.

Scan Complete Sound Setting

Sets the scan complete sound to be heard when an original is scanned.

Disable Switching of Display Order

Disables to change the order of display (search number order, ascending, descending).

Once set, the display sequence is not changed. The display order will remain fixed at the order that is in effect when this setting is enabled.

Hold Setting for Received Data Print

This function holds received faxes and Internet faxes in memory without printing them. The faxes can be printed by entering a password (factory default setting: 0000) with the numeric keys.

Password

When [Hold Setting for Received Data Print] is enabled, enter the password (4-digit number).



These settings can only be configured when there is no received data in the machine memory (excluding data in a confidential or relay broadcast memory box).



Default Verification Stamp

This is used to enable or disable the default setting. Enable this to always affix the verification stamp on the original that has already been scanned using the automatic document feeder. Configure the setting for each of the following items:

- E-mail/Scan/Data Entry
- Fax/Internet Fax

Erase Width Adjustment

This is used to set the default erase width for erase function. Specify a value from 0 mm (0") to 20 mm (1") in increments of 1 mm (1/8") for both edge erase and centre erase.

Time Specified Output of Received Data

This function is available when the Received Data Image Check Setting is enabled.

* This is displayed when a facsimile expansion kit or Internet fax expansion kit is installed.

If "Time Specified Output of Received Data" is set to , this setting is greyed out.

If "Change Password" or "Hold Setting for Received Data Print" is set to , the password entry field is greyed out.

Enable/Disable Settings

Settings to Disable Registration

Storing from the machine, storing from Setting mode (Web version), and storing from the PC can each be separately prohibited.

Disable Registering Destination from Operation Panel

Disables address control from the machine.

Configure the setting for each of the following items:

- Group (Direct Entry)
- Group (Address Book)

Select All: Selects all items.

Clear Checked: Clears all selections.

Disable Registering Destination on Web Page

Disables to store the destination from Setting mode (Web version).

Configure the setting for each of the following items:

- Group (Direct Entry)
- Group (Address Book)
- Contacts

Select All: Selects all items.

Clear Checked: Clears all selections.

Disable Registration/Deletion of All Program Items

This is used to prohibit the deletion and changing of image send settings stored in job programs.

Disable Registration of Memory Box

Disables all types of memory box registration.

Configure the setting for each of the following items:

Polling Memory, Confidential, Relay Broadcast (Direct Entry), Relay Broadcast (Address Book)

Disable Destination Registration Using Global Address Search

This disables address control from the global address search.

Configure the setting for each of the following items:

E-mail, Internet Fax, Fax

Disable Registration Using Network Scanner Tool

This disables address control from the Network Scanner Tools.

Use this option to suppress to store data of another machine through Inbound Routing of address book.

Disabling of Forwarding via Network

This prohibits inbound routing.

Settings to Disable Transmission

These settings are used to disable the following transmission operations.

**Disable [Resend] on Fax/Image Send Mode**

This setting disables the [Resend] key in the base screen of image send mode.

Disable Selection from Address Book

Disables the selection of destinations from the address book.

Configure the setting for each of the following items:

- E-Mail
- FTP
- Desktop
- Network Folder
- Internet Fax (Including Direct SMTP)
- Fax

Select All: Selects all items.

Clear Checked: Clears all selections.

Disable Direct Entry

Disables the direct entry of destination address and others.

Configure the setting for each of the following items:

- E-Mail
- Network Folder
- Internet Fax (Including Direct SMTP)
- Fax

Select All: Selects all items.

Clear Checked: Clears all selections.

Disabling of PC Scan

This prohibits PC scan transmission.

Disable Storing to External Memory Device

Disables to store to the external memory device.

Disable PC-I-Fax Transmission

This prohibits PC-I-Fax transmission.

Disable PC-Fax Transmission

This prohibits PC-Fax transmission.

Disabling of Find My Address

This prohibits Find My Address.

Own Name and Destination Set

Stores the Internet-Fax or Fax sender information.

Sender Data Registration

Use this to store the sender name for fax and Internet fax, the sender fax number, and the sender address for Internet fax. The stored sender name and sender fax number or Internet sender address will be printed at the top of the received fax.

Sender Name

Enter the sender name. A maximum of 20 characters can be entered for the sender name.

Sender Fax Number

Sets the sender fax number.

To insert a pause between digits of the number, tap the [-] key.

To insert a space between digits of the number, tap the [Space] key.

I-Fax Own Address

Enter a default sender address (maximum of 56 characters).

Registration of Own Name Select

Stores the sender name used in "Own Name Select" of another function. Up to 18 sender names can be stored.



Add New

Store a sender name. A maximum of 20 characters can be stored.

After entering a sender name, tap the [Store] key.

The lowest unused registration number from 01 to 18 will be automatically assigned to the sender name. This number cannot be changed.

Sender Name List

Displays a list of stored sender names.

When you select a sender name, it is deleted.

Scan Settings

Settings related to the image send function (E-Mail, FTP/Desktop, etc.) can be configured.



For an explanation of settings related to the fax function, see "[Image Send Settings \(page 7-180\)](#)"

Initial Status Settings

The following settings are related to the scanner.

Default Colour Mode Settings

Select a default colour mode setting for both colour and black & white in e-mail address, network folder, FTP and Desktop. Specify "Scanner Common" unless E-mail is specified.

Settings

Auto (Mono2, Greyscale*), Full Colour, Greyscale, Mono2

* When scanning a black and white original with the colour mode set to [Auto]

Disable Change of B/W Setting in Auto Mode: Disables black & white settings from the base screen when the colour mode is set to Auto.

Initial File Format Setting

Specify the initial file format for sending a file in E-mail, Network Folder, FTP, or Desktop mode. Specify "Scanner Common" unless E-mail is specified.

File Type

PDF, PDF/A, TIFF, JPEG*¹, Compact PDF*^{2, 3}, Compact PDF (Ultra Fine)*^{2, 3}, Compact PDF/A*^{3, 4}, Compact PDF/A (Ultra Fine)*^{3, 4}, Encrypt PDF, Encrypt/Compact PDF*^{3, 5}, Encrypt/Compact PDF (Ultra Fine)*^{3, 5}, XPS, RTF*⁶, TXT (UTF-8)*⁶, DOCX*⁶, XLSX*⁶, PPTX*⁶

*¹ When [Black & White] is selected, the format is [TIFF].

*² On the MX-3050V/MX-3550V/MX-4050V/MX-5050V/MX-6050V, the Enhanced compression kit is required. When [Black & White] is selected, the format is [PDF].

*³ When using the MX-2630N, Compact PDF cannot be selected because the enhanced compression kit cannot be installed.

*⁴ On the MX-3050V/MX-3550V/MX-4050V/MX-5050V/MX-6050V, the Enhanced compression kit is required. When [Black & White] is selected, the format is [PDF/A].

*⁵ On the MX-3050V/MX-3550V/MX-4050V/MX-5050V/MX-6050V, the Enhanced compression kit is required. When [Black & White] is selected, the format is [Encrypt PDF].

*⁶ Can only be enabled on the MX-3060V/MX-3070V/MX-3560V/MX-3570V/MX-4060V/MX-4070V/MX-5070V/MX-6070V.

OCR (Only on the MX-3060V/MX-3070V/MX-3560V/MX-3570V/MX-4060V/MX-4070V/MX-5070V/MX-6070V)

When the file format is PDF, characters in a scanned image are recognized and added to the PDF as text information.

Black & White

Compression Mode: None, MH (G3), MMR (G4)

Colour/Greyscale

Data compression ratio: Low, Medium, High.

Bk Letter Emphasis

**Specified Pages per File**

Generates a separate file for each scanned page when multiple pages are scanned.

If this setting is enabled, a number of pages per file can be specified.

OCR Setting (Only on the MX-3060V/MX-3070V/MX-3560V/MX-3570V/MX-4060V/MX-4070V/MX-5070V/MX-6070V)

Configure the settings that are required for OCR.

Font (Only on the MX-3060V/MX-3070V/MX-3560V/MX-3570V/MX-4060V/MX-4070V/MX-5070V/MX-6070V)

Set the font used for each recognized character language.

Detect Image Direction (Only on the MX-3060V/MX-3070V/MX-3560V/MX-3570V/MX-4060V/MX-4070V/MX-5070V/MX-6070V)

The orientation of the scanned original is automatically detected.

File Name Extraction (Only on the MX-3060V/MX-3070V/MX-3560V/MX-3570V/MX-4060V/MX-4070V/MX-5070V/MX-6070V)

Extract the file name.

Specified Pages per File

Generates a separate file for each scanned page when multiple pages are scanned.

If this setting is enabled, a number of pages per file can be specified.

Page No.

Any number of pages can be specified as the number of pages per file. This setting can be used if [Specified Pages per File] is enabled.



When [JPEG] is selected for the file type, [Specified Pages per File] cannot be selected.

Easy Scan Settings

Set the default colour mode for Easy Scan.

Set [Colour] for when the Colour Start key is tapped, and [Black & White] for when the B/W Start key is tapped.

Setup Items	Setting
Colour	Auto Full Colour
Black & White	Greyscale Mono2

Resolution Setting

The following settings are available for the default resolutions of common scan, E-mail, Internet fax, and fax mode.

Scanner Common

100 X 100 dpi, 150 X 150 dpi, 200 X 200 dpi,
300 X 300 dpi, 400 X 400 dpi, 600 X 600 dpi

E-mail

100 X 100 dpi, 150 X 150 dpi, 200 X 200 dpi,
300 X 300 dpi, 400 X 400 dpi, 600 X 600 dpi

Condition Settings**Default Reply.Address Set**

The information stored here is used if you do not specify [Reply to] in the send settings when performing Scan to E-mail.

PDF Compression Options**Flate Compression**

When sending a PDF file, you can compress the file by Flate Compression to reduce the file size.

Compression Mode at Broadcasting

Selects the compression mode for broadcasting using Scan to E-mail or Internet fax. The compression mode set here is used for all destinations regardless of their individual compression mode settings.



Black & White

MH (G3), MMR (G4)

Colour/Greyscale

Low, Medium, High

Bk Letter Emphasis

Send Destination Link Settings

Enable this to send only the URL of scanned data to the destination.

Enable Send Destination Link as Default

Enable this to always send only the URL of scanned data to the destination. When this function is enabled and you are in simple mode, only the URL is sent to the e-mail address. When normal mode is used, the [Send Destination Link] checkbox is always in the action panel that appears in the home screen of Scan to E-mail.

File Retention Period

Set the save period for scanned data saved in the machine when sending only the URL to the destination. When this period elapses, the files are automatically deleted.

Enable SSL

Use this to protect files using SSL transmission.

Maximum Size of E-mail Attachments(E-Mail)

To prevent the transmission of excessively large image files by Scan to E-mail, a file size limit can be set from 1 MB to 10 MB in increments of 1 MB. If the total size of the image files created by scanning the original exceeds the limit, the image files are discarded.

If you do not wish to set a limit, select [Unlimited].



This setting is linked to "[Maximum Size of E-mail Attachments \(page 7-104\)](#)" of the Internet fax settings.

If the E-mail attachment(s) exceed maximum size, it will be sent in multiple files.

If an E-mail attachment exceeds the maximum size, it will be sent in multiple files. If one of the divided files exceeds the maximum size, it will be sent with the resolution automatically lowered.

When sending files in JPEG format, only one file is attached to one e-mail, regardless of the file size. (Only on the MX-3060V/MX-3070V/MX-3560V/MX-3570V/MX-4060V/MX-4070V/MX-5070V/MX-6070V)

If a file scanned in TXT(UTF-8), RTF, DOCX, XLSX, or PPTX format exceeds the file size limit, the file will be discarded without being sent even if this setting is selected.



- When a file scanned to a format other than TXT(UTF-8), RTF, DOCX, XLSX, or PPTX exceeds the size limit, this function reduces the data size below the limit by lowering the resolution or other means, and thereby enables sending without cancelling the data. (Only on the MX-3060V/MX-3070V/MX-3560V/MX-3570V/MX-4060V/MX-4070V/MX-5070V/MX-6070V)
- When multi-crop, Image Crop, Send Destination Link and card scan are used, the scanned data is not divided.
- If the e-mail exceeds the set size limit, a send error occurs.

Maximum Size of Data Attachments(FTP/Desktop/Network Folder)

A limit can be set for the size of files that can be sent by Scan to FTP, Scan to Desktop, and Scan to Network Folder.

Limits that can be selected are 50 MB, 150 MB, and 300 MB. If the total size of the image files created by scanning the original exceeds the limit, the image files are discarded.

If you do not wish to set a limit, select [Unlimited].



During broadcasting that includes both e-mail and Internet fax destinations, the limit set in "[Maximum Size of E-mail Attachments\(E-Mail\) \(page 7-99\)](#)" precedes.

Bcc Setting

Enable Bcc

Enable this setting if you wish to use Bcc delivery. Displays the [Bcc] key on the image send address book screen.



Display Bcc Address on the Job Status Screen

Displays Bcc addresses on the job status screen and address list tab.

Auto Scan Setting (Only on the MX-3060V/MX-3070V/MX-3560V/MX-3570V/MX-4060V/MX-4070V/MX-5070V/MX-6070V)

Configure auto scan setting.

Set Image Orientation Automatically

The orientation of placed originals can be automatically detected. Set whether the original is scanned by one-sided scanning or two-sided scanning.

Set Resolution Automatically

You can have the machine automatically set the resolution.

Blank Page Skip

Set whether or not blank original pages are automatically skipped during scanning.

Disable Scan Function

Specify this to disable remote PC scanning and storing to external memory device.

Preset restriction of E-mail for direct input

Enable this setting to prohibit e-mail transmission to an address that has an unsuitable domain. A file will not be sent if the e-mail address is entered directly and the domain is one of the set domains.

Default Address

Default Address Setting

A default address can be stored that makes it possible to transmit by simply pressing the [Colour Start] key or the [B/W Start] key without specifying an address. If [Apply E-mail address of the user for login.] is selected, the E-mail address of the login user is set as the default destination. When [Apply Home Directory of The User for Login] is selected, the default address is the home directory of the user that logged in.

When the user logs in by internal authentication (authentication by the machine), the home directory setting of the user that logged in is configured in "User Registration" in "User List" in "User Control". When the user logs in by external authentication (network authentication), the home directory setting is configured in "Global Address Book Settings" in "LDAP Settings" in "Network Settings".



Only a single default address can be set for Scan to E-mail, Scan to FTP, Scan to Desktop, and Scan to Network Folder.

Add Selected

Select an address that is to be used by default.

Apply E-mail address of the user for login.

The E-mail address of the login user is set as the default address.

Select [Allow cancel of the first entered address] based on your intended use.

Apply Home Directory of The User for Login

The home directory of the login user is set as the default address.

Select [Allow cancel of the first entered address] based on your intended use.

Allow cancel of the first entered address

You can cancel the E-mail address of the login user that is entered automatically. To cancel, tap the [x] button next to the address entry field. When this setting is disabled, selection of an address other than the entered default address is prohibited.



If an e-mail address is not set for the logged-in user, scanner transmission cannot be used.

Select From Address Book

- To display your desired address book, narrow the search by alphabet or category with the list of [Index]. You can select the number of addresses that are to be displayed at a time with [Display Items].
- When you select the desired address name and tap the [Store] key, the selected address can be selected for the default address.



Administration Settings

Advanced Settings

Disable Selection of Reply-to.

Prohibit select of transmission destinations.

File Naming

You can select the information included in the name of scanned files.

Unit Serial Number

You can add the machine's serial number to the file name.

Text

You can add any text to the file name. (Up to 64 characters)

Sender Name

You can add the sender's name to the file name.

Date & Time

You can add the date and time of transmission to the file name.

Session Page Counter

You can add counter information to the file name.

Unique Identifier

An ID number can be created for each file and added to the file name.

Note: To prevent duplicate file names, select Date or Unique Identifier.

Default Subject

Set a maximum of 80 full-width/half-width characters for the default subject for E-mail and Internet Fax transmission.

Add Job Information Automatically to the Mail Message Body

You can automatically add job information to the body message of e-mail.

Add a Footer Automatically to the Mail Message Body

You can add any text as a footer to the body message of e-mail.

Mail Footer Registration

When [Add a Footer Automatically to the Mail Message Body] is enabled, set a maximum of 900 full-width/half-width characters for the footer.

Subject Name Settings

You can save a preset subject for transmitted files. Click the [Add] key and set a maximum of 80 full-width/half-width characters for the subject.

File Name Settings

You can save a preset file name for transmitted files. Click the [Add] key and set a maximum of 80 full-width/half-width characters for the file name.

Message Body Settings

You can save a preset e-mail subject and body message (fixed text). Click the [Add] key and set a maximum of 80 full-width/half-width characters for the subject, and a maximum of 1800 full-width/half-width characters for the body message (fixed text).



Internet Fax Settings

Settings related to the image send function (Internet fax, Direct SMTP, etc.) can be configured.



For an explanation of settings related to the fax function, see "[Image Send Settings \(page 7-180\)](#)".
These settings can be configured when the Internet fax expansion kit is installed.

Default Settings

Configures the default settings for Internet fax.

Resolution Setting

Apply the Resolution Set when Stored

You can apply the resolution setting that was set when the file was saved to transmission of the file.

Resolution Setting

Set the resolution used for file transmission.

Half Tone

Enable half-tones.

Auto Wake Up Print

When the [Power] button is "Off" (but the main power switch is "On") and an Internet fax is received, this function activates the machine and prints the fax.

When this function is disabled, received Internet faxes are not printed until the ([Power] button) is switched "On".

Initial File Format Setting

File Type

This is used to set the file type for Internet fax transmission.

The following settings can be configured.

- TIFF-S
- TIFF-F

If one of the following functions is set, the image will be sent in TIFF-F format even if TIFF-S is set.

- Mixed Size Orig.
- Dual Page Scan
- Book Divide
- Card Shot
- N-Up

Compression Mode

This is used to set the compression mode for Internet fax transmission.

The following settings can be configured.

- MH (G3)
- MMR (G4)



[MMR (G4)] cannot be selected when [File Type] is set to [TIFF-S].

Speaker Volume Settings

Adjusts the volume of fax receive signals and communication error signals heard through the speaker.

A fax receive signal sounds after the machine checks the mail server and retrieves received faxes. A communication error signal sounds when a delivery failed e-mail is received from the destination Internet fax machine.



Original Print on Transaction Report

When a transaction report is printed, this is used to print part of the first page of the transmitted original on the transaction report. Select one of the settings below.

- Always Print
- Print at Error
- Do not Print

This setting will not be effective if the next "[Transaction Report Print Select Setting \(page 7-103\)](#)" is set to "Do not Print".

Transaction Report Print Select Setting

Selects whether or not a transaction report will be printed, and if printed, the condition for being printed. Select a setting for each of the following operations:

Single Sending

- Always Print
- Print Out Error Report Only
- Do not Print

Broadcasting

- Always Print
- Print Out Error Report Only
- Do not Print

Receiving

- Always Print
- Print at Error
- Do not Print

When a transaction report is printed, this is used to print part of the first page of the transmitted original on the transaction report. For more information, see "[Original Print on Transaction Report \(page 7-103\)](#)".

Activity Report Print Select Setting

Prints the Image Sending Activity Report stored in the machine memory periodically.

The Image Sending Activity Report can be set to print each time the number of transactions reaches 200, or at a specified time (once a day only). (The settings can be simultaneously enabled.)



- If you only select the "Print Daily at Designated Time" setting and the number of recorded transactions reaches 200 before the specified time, each new transaction will delete the oldest transaction (the oldest transaction will not be printed).
- The Transaction Report can be printed out manually as needed.
See "[List for Administrator \(page 7-52\)](#)".

Body Text Print Select Setting

Image files attached to Internet faxes are normally printed. This setting can be enabled to also have the e-mail body text (subject and message) printed.

This setting also applies to printing of the body text of e-mail messages without file attachments.



A maximum of 5 pages of body text can be printed.



Send Setting

These settings are used to configure the settings for Internet fax.

I-Fax Reception Report On/Off Setting

This setting is used to request a reception report when an Internet fax is sent.

I-Fax Reception Report Request Timeout Setting

The duration of time that the machine will wait for a reception report from the destination machine can be set by any number from 1 hour to 240 hours in increments of 1 minute.



This setting is only effective when "[I-Fax Reception Report On/Off Setting \(page 7-104\)](#)" is enabled.

Number of Resend Times at Reception Error

The number of resend attempts when an error message is received from an I-Fax recipient can be set to any number from 0 to 15.



This setting is only effective when "[I-Fax Reception Report On/Off Setting \(page 7-104\)](#)" is enabled.

Maximum Size of E-mail Attachments

To prevent the transmission of excessively large image files by Internet fax, a file size limit can be set from 1 MB to 10 MB in increments of 1 MB. If the total size of the image files created by scanning the original exceeds the limit, the image files are discarded.

If you do not wish to set a limit, select [Unlimited].



This setting is linked to "[Maximum Size of E-mail Attachments\(E-Mail\) \(page 7-99\)](#)" in Scan Settings.

Rotation Sending Setting

When transmitting an image that is one of the following sizes, this function rotates the image 90 degrees counterclockwise. (The setting can be configured separately for each size.)

A4, B5R, A5R, 8-1/2"x11", 5-1/2"x8-1/2"R



A4R and 8-1/2" x 11"R size images are not rotated.

Default Own Number Sending

You can include the date and your sender information (sender name and address) at the top of the page when the receiving machine prints an image that you send.

Printing Page Number at Receiver

When the transmitted image is printed by the receiving machine, the page number can be added to the top of each printed page.

Recall in Case of Line Busy

(This setting is only effective for Direct SMTP transmission.)

This setting sets the number of recall attempts and the interval between recall attempts when a transmission is not successful due to the line being busy or other reason.



Number of Times to Recall When Line is Busy

This setting specifies whether or not recalling is performed when the line is busy. During recalling, you can set the number of recall attempts. Any number from 0 to 15 can be selected.

Interval to Wait Between Recall Attempts (min.) When Line is Busy

The interval between recall attempts can be set. Any number of minutes from 1 to 15 can be selected.

Recall in Case of Communication Error

(This setting is only effective for Direct SMTP transmission.)

This determines how many times the machine will automatically attempt the call again if a fax transmission fails due to a communication error.

Number of Times to Recall in Case of Error

Specify how many times the machine will attempt the call again when a communication error occurs. During recalling, you can set the number of recall attempts. Any number from 0 to 15 can be selected.

Interval to Wait Between Recall Attempts (min.) in Case of Error

The interval between recall attempts can be set. Any number of minutes from 1 to 15 can be selected.

Receive Settings

Configures the settings for Internet fax.

Auto Receive Reduce Setting

When a fax is received that includes printed information such as the sender's name and address, the received image is slightly larger than the standard size. This setting is used to automatically reduce the image to fit the standard size.



- If Auto Receive Reduce is disabled, the edges of the image outside the standard size will be cut off. However, the image will be clearer because it will be printed at the same size as the original.
- Standard sizes are sizes such as A4 and B5 (8-1/2" x 11" and 8-1/2" x 5-1/2").

2-Sided Printing of Received Data

This is used to have received faxes printed on both sides of the paper.

When this setting is enabled and a fax consisting of 2 or more pages is received (the pages must be the same size), the pages are printed on both sides of the paper.

Set Address for Data Forwarding

When the machine cannot print a received fax, the fax can be forwarded to another machine. This setting is used to configure the address of the other machine.

Forwarding to

Enter the forwarding address (maximum of 64 characters).

Direct SMTP

Select this to enable forwarding when direct SMTP is used.

Add Hostname or IP Address.

Select this to separately enter a host name or IP address.

Hostname or IP Address

Use this setting when "Add Hostname or IP Address." is enabled. Enter the host name or IP address (maximum of 64 characters).



- Multiple forwarding addresses cannot be stored.



Letter Size RX Reduce Print

When an A3 size fax is received, this function reduces the fax to ledger (11" x 17") size.



When this setting is enabled, ledger (11" x 17") size faxes are also reduced.

Receiving Date & Time Print

Enable this setting to have the date and time of reception printed.

Select [Inside the Received Image] or [Outside the Received Image] for the position where the date and time is printed.

When [Inside the Received Image] is selected, the date and time of reception is printed on the received image.

When [Outside the Received Image] is selected, the received image is reduced and the date and time of reception is printed in the blank area that results.



The [Outside the Received Image] cannot be selected for the reception date and time print setting if "[Auto Receive Reduce Setting \(page 7-105\)](#)" is not enabled.

A3 RX Reduce

When an A3 size fax is received, this function reduces the fax to ledger (11" x 17") size.



When this setting is enabled, ledger (11" x 17") size faxes are also reduced.

POP3 Communication Timeout Setting

The duration of time the machine waits until stopping reception can be set from 30 to 300 seconds in increments of 30 seconds if no response is received from the mail server (POP3 server).

Reception Check Interval Setting

Specifies an interval at which the machine automatically checks the mail server (POP3 server) for received Internet faxes. The interval can be set from 0 minutes to 8 hours in increments of 1 minute.

If 0 hours 0 minutes is specified, the machine does not automatically check the mail server for received Internet faxes.



The machine also checks the mail server (POP3 server) for received Internet faxes when the main power is switched on. (Except when 0 hours 0 minutes is specified.)



Allow/Reject Mail or Domain Name Setting

Allows or refuses a reception from specified addresses/domains.

Item	Settings
Item	Reception from the stored address/domain is not allowed.
Allow Reception	Reception from the stored address/domain is allowed.
All Invalid	All Invalid
Add New	Adds a new address or domain (maximum of 50) from which reception is to be rejected or allowed. Enter the address/domain (maximum of 64 characters) and tap the [Store] key. If the first character of the entry is not "@", the entry is identified as an address. If the first character is "@", the entry is identified as a domain. (xxx@xx.xxx.□□□ is treated as an address, and @xx.xxx.□□□ is treated as a domain.) Storing an address specifies only that address. Storing a domain specifies all addresses that include that domain.
Registered address or domain list	Displays a list of the stored addresses and domains. An address or domain can be deleted from the list when selected.



When there are no stored anti junk mail addresses or domains, only the [Add New] key can be selected.

Server Settings

Receive Settings

Internet Fax Receive

Set whether or not Internet Fax reception is performed.

POP3 Server

Enter a maximum of 127 half-width characters for the name of the POP3 server to be used.

Port Number

Specify the port number of the POP3 server to be used.

POP Authentication

Set to use POP authentication.

User Name

Enter a maximum of 64 characters for the user name used to access the server.

Password

Enter a maximum of 32 characters for the password used to access the server.

POP3 Communication Timeout

Set a timeout for communication to the POP3 server.

Reception Check Interval Setting

Enter an acknowledge cycle to the POP3 server.

Enable SSL

Use SSL to encrypt data before transmission.

Default Settings

Own Number and Name Set

Set I-Fax Own Name

Enter a maximum of 20 full-width/half-width characters for the sender name for Internet Fax transmission.

Source Address

Enter a maximum of 56 half-width characters for the sender address for Internet Fax transmission.



Direct SMTP Setting

Port Number (Receive), Port Number (Send)

Specify the port number used for transmission and reception by direct SMTP.

Timeout

Set the wait time until transmission or reception is cancelled when a response is not received from the server during direct SMTP transmission/reception.

Fax Data Receive/Forward (Manual)

Internet Fax Settings

These settings can be configured when the Internet fax expansion kit is installed.

Reception Start

Tap this key to immediately connect to your mail server (POP3 server) and check for received Internet faxes. If you have received Internet faxes, the faxes will be retrieved and printed.

Manual Reception Key in Initial Screen

This displays the [Internet Fax Manual Reception] key in the base screen of Internet fax mode.

Forward Received Data

When the machine cannot print because it is out of paper or out of toner, received faxes can be forwarded to another Internet fax machine.



To cancel forwarding

Tap the job status display and cancel fax forwarding in the similar way as for a transmission job. Forwarding is not possible if no faxes were received or a forwarding fax number is not programmed.



- For an explanation of settings related to the fax function, see "[Fax Data Receive/Forward \(Manual\) \(page 7-191\)](#)".
- To enable "Reception Start", the POP3 server settings must be configured. See [Application Settings] in "Settings" → [Internet Fax Settings].
- To register a forwarding address, see "[Set Address for Data Forwarding \(page 7-105\)](#)" in "Settings".
- If forwarding was not successful because the transmission was cancelled or a communication error occurred, the faxes that were to be forwarded will return to the print queue on the machine.
- If the initial pages of a fax were successfully printed, only those pages that were not printed will be forwarded.
- If you select [System Settings] in "Settings" → [Image Send Settings] → [Operation Settings] → [Default Settings] and if "Hold Setting for Received Data Print" is enabled, you are prompted to enter a password. Enter the correct password using numeric keys.



Inbound Routing (Forwarding/Storing) Settings

Inbound Routing Settings

The fax and Internet fax received data can be forwarded according to the stored forwarding table.

When this function is enabled, you can also have the received Internet faxes forwarded to a specified e-mail address without printing them.

Table Registration

You can store or edit the data forwarding table that has the received data forward settings.

Up to 50 data forwarding tables can be stored.

A single forwarding table can store up to 500 sets of sender number and source address combinations.

Up to 1000 destinations can be stored in all data forwarding tables combined.

Up to 100 destinations of FTP/Desktop/Network Folder data can be stored.

List name	Settings
Table Name	Enter a forward table name.
Receive Line Select	Selects a data receive line.
Sender Address Setting	Select the sender facsimile number or the Internet fax address.
	Before you select a sender number or address, store the destination number or address.
	To forward all received data, select [Forward All Received Data].
Forward Condition 1/2/3	<p>You can set the forwarding date and destination.</p> <ul style="list-style-type: none"> Forward Condition: Set the data forwarding conditions. Day of the Week: Select a day of week to start data forwarding. Start Time: Set a time to start data forwarding. Completing Time: Set a time to end the data forwarding. Format for Forwarding: Select a format of forwarding data.
Forwarding Destination List	Lists the addresses that can be set as the destination. Select a destination by setting it to <input checked="" type="checkbox"/> .
Add (Selecting from Address Book)	Open the address book and enter a forwarding destination.
Add (Direct Entry)	Enter the destination name directly.
Delete	Deletes the selected address.

Sender Address Registration

Stores new sender number or address to be used for inbound routing.

List name	Settings
Address to be Entered	Displays the entered sender number or address.
Fax Number	Enter a facsimile number to be stored as the sender. When you enter multiple sender numbers, separate them by a semicolon (;) or a comma (.). When you tap the [Global Address Search] key, the global address search screen appears.
Internet Fax Address	Enter an Internet fax address to be stored as the sender. When you enter multiple sender numbers, separate them by a semicolon (;) or a comma (.). When you tap the [Global Address Search] key, the global address search screen appears.
Delete	Deletes the selected sender number or address.
Add to List	Adds the entered sender number to the list.



Administration Settings

Stores the administration settings to be used for inbound routing.

List name	Settings
Disable Registration of Forward Table	Disables the registration of forward table.
Disable Change/Delete of Forward Table	Disables a change of forward table.
Disabling of Forward Condition Change	Disables a change of data forwarding conditions.
Disable Temporal Forward Setting from Operation Panel	Disables a temporal data forward setting from the machine.
Print Style Setting	Sets a print style of received data. If you have selected the [Always Print] or [Save Only at Error] option, enter a file name.
Preset of Character	Set the characters added to the file name when a file is saved. When "Character 1" and "Character 2" are set in "File Naming No. 1 to No. 7", the set characters are added to the file name. Enter up to 64 full-width/half-width characters.
File Naming No.1 - No.7	Set the information included in the file name when saving a file.
If received from a contact registered in the address book, sender's name is changed to contact's name.	When the sender of the data is stored in the address book, the sender information is changed to the name stored in the address book.

1

Enable the [Inbound Routing] function.

Tap the [Administration Settings] from the menu.
Enable the [Inbound Routing] function from the setting screen.

2

Store the sender number or address.

Tap the [Sender Number /Address Registration] from the menu.
Enter the destination number or address that you wish to store.



If you wish to forward all received data, you need not store the sender number and address separately.

3

Store a forwarding table.

Tap the [Inbound Routing Settings] from the menu.
Tap the [Add] key on the displayed screen.
When the [Table Registration] screen appears, store the forwarding table.

4

Enable the stored forwarding table.

Tap the [Inbound Routing Settings] from the menu.
Set the forwarding table name that you wish to enable to .
To specify forwarding conditions, select [Forward based on the Conditions of Forward Destination 1-3], and also select [Always Forward] or [Forward on Selected Day & Time]. If you have selected the [Forward on Selected Day & Time] option, you can set the forwarding date and time in advance.



Inbound Routing (Storage) Settings

Settings for HDD Storing of Received Data

An external account application can be added and controlled. Configure settings for saving received faxes to the hard disk.

Item	Settings
Auto Storing of Received Data in HDD	Set whether received faxes are saved to the hard disk.
Specifying Data to be Stored	Select which received faxes are saved. Select from lines 1 to 3 and Internet Fax.
Specifying Stored Folder	Specify the folder in which received faxes are saved. Enter a folder name no longer than 32 full-width/half-width characters.
Sort Received Faxes by Date in Folders	Configure settings to have date folders created and received faxes saved to the folders by date.
File Format	Select the file format for inbound routing.
Print Style Setting	Configure print settings for received faxes. <ul style="list-style-type: none">• Save and print: Save received faxes to hard disk, and also print.• Only print when save error occurs: Print received fax when save fails.• Save in inbound routing error box when save fails: When save fails, save the fax in the inbound routing error box.
Preset of Character	Set the characters added to the file name when a file is saved. When "Character 1" and "Character 2" are set in "File Naming No. 1 to No. 7", the set characters are added to the file name. Enter up to 64 full-width/half-width characters.
File Naming No.1 to No.7	Set the information included in the file name when saving a file.
If received from a contact registered in the address book, sender's name is changed to contact's name.	When Sender name of "File Naming" is enabled, you can change the sender name to a name in the address book.
Reception Notification Settings	Set whether notification is sent by e-mail when a fax is received.
Address of Notification Destination	Shows the address to which the notification is sent.
Direct Entry	Enter the notification address. Enter a maximum of 1500 half-width characters for the address.
Global Addr. Search	Select the address from the global addresses.
Add to List	An address directly entered or found by global address search is saved as the notification address.



Metadata Settings

If the Application Integration Kit is installed, you can control the metadata to be used in other applications.

The stored metadata is displayed on the metadata settings page. You can add a metadata, and edit or delete an existing metadata.

- **[Add] key**
Adds a new metadata set.
- **List**
Lists the currently stored metadata sets.

Metadata Delivery

Enables or disables the metadata delivery function.

Metadata Set Registration

When you tap the [Add] key, the registration screen appears. Up to 10 items can be stored.

For information on the settings, see "[Settings \(page 7-112\)](#)".

Edit or Delete Metadata Set

When you tap a title on the list, the edit screen appears for that metadata set.

Tap the [Delete] key to delete the metadata set.

Settings

Item	Settings
Metadata Set Name	Enter a metadata name.
Metadata Destination	Select a destination where you wish to send the image and metadata.
Allow Custom Filenames	Enable or disable to edit the name of image file and XML file to be sent by the metadata send job.
Address Type Allowing Metadata Entry	Set the destination information to be used for metadata transmission.
Name	Enter a metadata name to be displayed on the touch panel.
XML Tag Name	XML Tag Name
Entry Type	<ul style="list-style-type: none">• Direct entry: Allows direct entry of each metadata from the soft keyboard or the numeric keypad.• Metadata list: Allows a selection of metadata from the previously entered data list. You must enter optional values for metadata selection in the input area. Entries must be separated by semicolons or commas. Each option can be comprised of up to 70 characters.• Initial entry by default: Uses a default value as the first value of the entered metadata list.
Include MFP Extended Scan Settings in XML File.	When the machine generates metadata automatically, the "metadataSetName", "userLoginId" (if user authentication is used), "pageSize", and "imageMode" are added to the metadata.
To Be Used as Default	The current metadata set is used as the default.



Document Filing Settings

Condition Settings

Document filing settings are described below.

Select [Document Filing Settings] to configure the settings.

Default Mode Settings

Specifies which mode, Sharing or Confidential, is used as the default mode when storing a file.

When [Confidential Mode] is selected, the [Confidential] checkbox is set to on the information screen for filing.

Sort Method Setting

Selects an order of display files stored in the Main Folder, Custom Folder, and Quick File Folder. Select one of the following settings:

- File Name
- User Name
- Date

Administrator Authority Setting

For files and user folders that have a password, this setting allows the administrator password to be entered instead of the password when accessing the file or folder.

Also, you can change the preset ratio if necessary.

Delete All Quick Files

Deletes all files from the Quick File folder except for protected files.

Delete

Tap this key to start deletion of all files immediately.

Delete quick files at power up. (Protected files excluded)

This is used to automatically delete all files in the Quick File Folder (with the exception of protected files) when the [Power] button is turned "On".



The condition of the machine may prevent deletion in some cases.

Image Orientation

Changes the image orientation.

Default Colour Mode Settings

Selects the default settings for black & white and colour when Scan to HDD is used.

The following settings can be configured.

- Auto
- Full Colour
- Greyscale
- Mono2

Disable Change of B/W Setting in Auto Mode

This setting disables selection of B/W settings from the base screen when the colour mode is set to Auto.

Default Exposure Settings

Default exposure settings for document filing can be configured.

Select [Auto] or [Manual].

If you select [Manual], set the exposure to one of 5 levels.



Default Original Image Type

Select the original type beforehand to enable scanning at a resolution suitable for the original. The following settings can be configured.

- Text/Printed Photo
- Text/Photo
- Text
- Photo
- Printed Photo
- Map



When the exposure is set to [Auto], a default original type cannot be selected.

Initial Resolution Setting

One of the following resolutions can be selected for the default resolution for transmission.

- 100x100dpi
- 150x150dpi
- 200x200dpi
- 300x300dpi
- 400x400dpi
- 600x600dpi

Scan Complete Sound Setting

Adjusts the volume of the beep that sounds when scanning ends. The beep can also be turned off.

Default Output Tray

Selects the default output tray for printing a file stored by Scan to HDD. The items that appear will vary depending the machine configuration.

Disable Text/Stamp functions for Reprinting

When a stored file is retrieved and printed, the printing functions are disabled. This function prevents an inconsistency of the date between the original data and output data and others.

Batch Print Settings

Set whether or not the [All Users] key and the [User Unknown] key are prohibited in the user name selection screen when printing all files, whether files are sorted by date in newest or oldest order, and whether file names are sorted in ascending or descending order.

Erase Width Adjustment

This is used to set the default erase width for erase function. Specify a value from 0 mm (0") to 20 mm (1") in increments of 1 mm (1/8") for both edge erase and centre erase.

Card Shot Settings

This is used to set the default original size for the card shot function. Specify a value from 25 mm (1") to 210 mm (8-1/2") in increments of 1 mm (1/8") for both the X (horizontal) and Y (vertical) dimensions of the original.

Fit to Store Size

Always displays the [Fit to Store Size] key on the card shot screen.

Setting of store/delete after file print

Select whether or not to save or delete a file after printing.



Default Setting of PDF Format for PC Browsing

You can set the initial file format of public PDF or the file for download which is created during execution of each job.

B/W : Compression Mode

None, MH (G3), MMR (G4)

Colour/Greyscale : Compression Ratio

Low, Middle, High

Settings during each job execution

When each of copy, printer, scanner, Internet fax, fax, or stored scan data is executed, you can specify to create a public PDF and to set the resolution of public PDF.

Document Output Options

The use of a stored file can be allowed or prohibited by operation type and by the mode from which the file was stored.



The items that appear will vary depending on the functions that have been added to the machine.

Item	Settings
Copy	For each mode, select whether or not copying of stored files is allowed.
Print	For each mode, select whether or not printing of stored files is allowed.
Scan Send	For each mode, select whether or not fax transmission of stored files is allowed.
Internet Fax Send(Incl. PC-I-Fax)	Select whether or not I-Fax transmission of stored files is allowed.
Fax Send(Incl. PC-Fax)	For each mode, select whether or not fax transmission of stored files is allowed.
Scan to HDD	For each mode, select whether or not stored files is allowed.

Document Filing Control

The registration method is the same as for a custom folder.

▶ [Custom Folder \(page 7-56\)](#)

Automatic Deletion of File Settings

Document filing settings are described below. Tap the [Document Filing Settings] key to configure the settings.

Time and folder settings can be configured to have files in specified folders (stored by document filing) automatically deleted at a specified time. Up to 3 settings can be stored to be automatically deleted.

The procedure for using this function is as follows:

- (1) Select [Setting 1], [Setting 2], or [Setting 3].
- (2) Set the time and date for automatic deletion.
- (3) Select the desired folder.
- (4) Specify whether or not protected files and confidential files are to be deleted.
- (5) Enable the stored settings.

Item	Settings
Schedule	Select an automatic deletion cycle. <ul style="list-style-type: none"> • Every Day: Auto deletion every day at the specified time. • Every Week: Auto deletion at the specified time on the specified day of the week. • Every Month: Auto deletion at the specified time on the specified day of the month.



Item	Settings
Folders	To select the folder separately, select [Folder Select] and select the desired folder. To select all folders, including the folder currently being created, select [All Folders (Including folders registered hereafter)].
Delete Protected File	Enable this setting to include protected files in the deletion.
Delete Confidential File	Enable this setting to include confidential files in the deletion.

Delete Now

When this is executed with a folder selected, all files in the folder will be immediately deleted regardless of the date and time setting.

Executing automatic deletion during Auto Power Shut-Off

(If this is not selected, the files will be deleted after the machine wakes from auto power shutoff mode.)

Execute Auto Deletion even if Auto Power Shut-Off is enabled. When the checkbox is not selected () , the files will be deleted after the machine wakes from auto power shutoff mode.

Sharp OSA Settings

Condition Settings

Cookie Setting

Specify how application cookies are handled when using an application in Sharp OSA.
When "Hold Cookie" is selected, the machine holds cookies that are used in an application.
When "Not hold Cookie" is selected, cookies are not held when an application is used.

Delete Cookie

Delete cookies held by the machine.

Standard Application Settings

The standard application settings can be added and controlled.

- [Add] key
Adds a new standard application.
- List
Lists the currently stored standard applications.

Store Standard Application

When you tap the [Add] key, the registration screen appears. Up to 16 items can be stored.
For information on the settings, see the following table.

Edit or Delete Standard Application

When you tap an application name on the list, the edit screen appears for that standard application.
Tap the [Delete] key to delete the standard application.



Settings

Item	Settings
Application Name	Enter an application name.
Address for Application UI	Set an IP address of the application or a network name to control the UI of the machine.
Timeout	Enter a timeout. The default setting is 20 seconds.
Browser	Select the Web browser type.
Extended Platform	Set this option to use the expansion platform.
Data Size	Set the screen size of application.
Use Custom Icon*	Select whether or not custom icon is used.
File Name*	Reports file name.
Select File*	Please enter File Name.

* These functions can be set only in the Web page.

Receiving Application Setting

The Fax or I-Fax Receive functions can be set in the Sharp OSA applications.

Settings

Item	Settings
Forward to Application	The Fax or I-Fax message reception can be controlled by Sharp OSA applications.
Application Name	Enter the application name to receive.
Address for Web Service	Enter the Web service address.
Timeout	Enter a timeout. The default setting is 20 seconds.
E-mail Address	Enter the address to which a notification e-mail is sent when an application connection error occurs.
Body Text	Enter the body message that appears in the notification e-mail for connection errors.
Connection Test	To test the connection to the application, click the [Execute] button.

External Accounting Application Settings

An external account application can be added and controlled.

Set the server name where you have installed the external accounting application.

Item	Settings
External Account Control	Enable the totalling function by the external accounting application. If enabled, always enter the application name or Web service address.
Set Authentication Server (Server 1)	If the server is set, the external authentication mode is selected. Any access to the MFP is controlled by the application that you set on this page. If set, always enter the application name, application UI address, or Web service address of server 1. If not set, the external totalling mode is selected.
Server 1-4	Set to enable each of the servers.
Application Name	Enter an application name.
Address for Application UI*	Enter the URL of the login screen to be accessed first when the machine is turned on.
Address for Web Service	Enter the URL of the server or computer which sends commands and events by XML/SOAP protocol.



Item	Settings
Timeout	Enter a timeout. The default setting is 20 seconds.
Browser*	Select the Web browser type.
Extended Platform	Set this option to use the expansion platform.
Data Size*	Set the screen size of application.
Find My Address*	This item is only displayed and cannot be set.
Target*	This setting determines whether the machine's user list or the LDAP server is searched when you perform a "My Address" search with Sharp OSA external authentication in use.
Communication Error Notification	
E-mail Address	Enter the address to which a notification e-mail is sent when an application connection error occurs.
Body Text	Enter the body message that appears in the notification e-mail for connection errors.

* This setting can be set in Server 1.

Embedded Application Settings

Store and manage “embedded applications” that are installed in the machine.

- [Add] key
Adds a new embedded application.
- List
Lists the currently installed embedded applications.

Install Embedded Application

When you tap the [Add] key, the registration screen appears. Up to 16 items can be installed.



- When installing from the operation panel of the machine, the files in the USB memory connected to the machine are installed. When installing from the Web page, the files in the computer are installed.
- The maximum area of the hard disk that applications can use is 2 GB. If previously installed applications are already using 2 GB of area, a new application cannot be installed.

Store Embedded Application

By storing an already installed embedded application in “standard application”, the application can be used. Select the application name checkbox and tap the [Add Standard Applications] key.

Delete Embedded Application

Tap an application name in the list to display the information of that standard application. After checking the information, delete the standard application with the [Delete] key.

Polling Setting

When linked to an external application, you can store and manage addresses in order to use a service that uses a polling function.

Item	Settings
Server 1 - Server 2	Set to enable each of the servers.
Polling Address	Enter the URL of the server or computer that the machine will poll.
Check Interval	Enter the check interval for the server. The default is 1 minute.
Timeout	Set the timeout time. The default setting is 20 seconds.



Common Settings

Paper Settings

Paper Tray Settings

Paper tray and paper type settings are explained in this section.

These settings specify the paper type, paper size, and functions allowed for each paper tray.

When [Paper Tray Settings] is selected, a list appears showing the trays and the current settings.

Auto Switching of Tray

When a tray runs out of paper during printing, this determines whether or not another tray with the same size and type of paper is automatically selected and printing continues.

Display Paper Tray Settings when bypass tray detects paper.

You can have the paper tray settings appear automatically when paper is detected in the bypass tray.

Settings of each tray

When the [Change] key is tapped, the corresponding setting screen appears.

The following settings can be configured.

List name	Description
Type	Select a type of paper to be loaded into the tray. The paper types that can be selected vary by paper tray. For more information, see " Tray Settings (page 7-120) ". To user type setup, see " Paper Type Registration (page 7-121) ".
Size	Select the paper size from the list. The paper sizes that can be selected vary by tray. The sizes that can be selected may also be restricted by the paper type selected above. For more information, see " Tray Settings (page 7-120) ". If the desired size does not appear in the list, select [Custom Size] and directly enter the size (only for the bypass tray). For more information, see " Tray Settings (page 7-120) ".
Sending Address List	Select the modes that can be used. If there is a function that you do not wish to be used with the selected tray, disable the function. When the "Type" is other than plain paper, recycled paper, coloured paper, or a user type, [Fax] and [Internet Fax] cannot be selected.



- If the paper size specified here is different from the size of paper that is loaded into a tray, a problem or misfeed may occur when printing.
- To change the paper size in a tray, see "[LOADING PAPER \(page 1-67\)](#)".
- Paper properties such as "Fixed Paper Side" are automatically set when the paper type is selected. The paper tray properties cannot be changed in this screen.
- If [System Settings] in "Settings" → [Common Settings] → [Device Control] → [Disabling of Tray Settings] is selected, the tray settings (except for the bypass tray) cannot be configured.
- Tray settings can only be changed in setting mode of the machine.



Tray Settings

Paper Tray	Paper Type	Size
Tray 1	Plain, Pre-Printed, Recycled, Letter Head, Pre-Punched, Colour, Heavy Paper 1 to 4*1, User Type	When using the MX-5050V/MX-5070V/MX-6050V/MX-6070V Auto-AB (A3W (12" × 18"), A3, B4, A4, A4R, B5, B5R, 216 mm × 330 mm (8-1/2" × 13")) Auto-Inch (12" × 18", 11" × 17", 8-1/2" × 14", 8-1/2" × 11", 8-1/2" × 11"R, 7-1/4" × 10-1/2"R) SRA3, SRA4, A5, A5R, 8-1/2" x 13-1/2", 8-1/2" x 13-2/5", 5-1/2" x 8-1/2"R
Tray 2 (when a paper drawer is installed)		When using the MX-2630N/MX-3050V/MX-3060V/MX-3070V/MX-3550V/ MX-3560V/MX-3570V/MX-4050V/MX-4060V/MX-4070V A3W, A3, A4, A4R, A5R, B4, B5, B5R, 320mm x 450mm, 225mm x 320mm 12" x 18", 11" x 17", 8-1/2" x 14", 8-1/2" x 11", 8-1/2" x 11"R, 5-1/2" x 8-1/2"R, 7-1/4" x 10-1/2", 8-1/2" x 13-1/2", 8-1/2" x 13-2/5", 8-1/2" x 13", A5
Tray 3 (when a paper drawer is installed)		Auto-AB (A3W, A3, A4, A4R, A5R, B4, B5, B5R, 11" x 17", 8-1/2" x 11", 320mm x 450mm, 225mm x 320mm) Auto-Inch (12" x 18", 11" x 17", 8-1/2" x 14", 8-1/2" x 11", 8-1/2" x 11"R, 5-1/2" x 8-1/2"R, 7-1/4" x 10-1/2", A3, A4, B4, B5, 320mm x 450mm, 225mm x 320mm) 8-1/2" x 13-1/2", 8-1/2" x 13-2/5", 8-1/2" x 13"
Tray 4 (when a paper drawer is installed)		
Tray 3 (when a stand/550&2100 sheet paper drawer is installed)	Plain, Pre-Printed, Recycled, Letter Head, Pre-Punched, Colour, User Type	A4, 8-1/2" × 11"
Tray 4 (when a stand/550&2100 sheet paper drawer is installed)		A4, B5, 8-1/2" x 11"
Tray 5 (when a large capacity tray is installed)	Plain, Pre-Printed, Recycled, Letter Head, Pre-Punched, Colour, Heavy Paper 1 to 2*1, User Type	A4, B5, 8-1/2" x 11"
Bypass Tray	In addition to the paper types in trays 1 to 4, Thin Paper, embossed paper, Envelope, transparencies, label sheets, Tab paper, Glossy Paper	Auto-AB (A3W (12" × 18"), A3, B4, A4, A4R*2, A5R, A5*2, B5, B5R, 11" × 17", 8-1/2" × 11", 216 mm × 330 mm (8-1/2" × 13"))*2, 216 mm × 340 mm (8-1/2" × 13-2/5")*2 (216mm × 343mm(8-1/2" × 13-1/2")*2) Auto-Inch (12" × 18", 11" × 17", 8-1/2" × 14", 8-1/2" × 13-2/5" (216 mm × 340 mm)*2, 8-1/2" × 11", 8-1/2" × 11"R, 7-1/4" × 10-1/2"R, 5-1/2" × 8-1/2"R, A3, A4, B4, B5), 320 mm × 450 mm, 225 mm × 320 mm Size Input-AB (X=140 mm to 457 mm, Y=90 mm to 320 mm) Size Input-Inch (X=5-1/2" to 18", Y=3-5/8" to 12-1/2") 8K, 16K, 16KR, Custom1 to Custom7

*1 Heavy paper 1: 106 g/m² to 176 g/m² (28 lbs to 46 lbs)
 Heavy paper 2: 177 g/m² to 220 g/m² (47 lbs to 58 lbs)
 Heavy paper 3: 221 g/m² to 256 g/m² (59 lbs to 68 lbs)
 Heavy paper 4: 257 g/m² to 300 g/m² (69 lbs to 79 lbs)

*2 The size that is automatically detected is set in "Select Paper Sizes for Auto Detection" in the bypass tray settings screen.



Select Paper Sizes for Auto Detection

"Select Paper Sizes for Auto Detection" in the bypass tray settings screen is used to select the paper size that is automatically detected from similar sizes when the automatic paper size detection takes place.

Select one of two sizes when "Auto-Inch" is set. Select one of five sizes when "Auto-AB" is set.

When paper that is the same size as one of the paper sizes in the settings is placed in the bypass tray, the size that is selected in the settings will be automatically detected.

List name	Description
Auto-AB	A4R, A5, 8-1/2" x 13" (216 mm x 330 mm), 8-1/2" x 13-2/5" (216 mm x 340 mm), 8-1/2" x 13-1/2" (216 mm x 343 mm)
Auto-Inch	8-1/2" x 14", 8-1/2" x 13-2/5" (216 mm x 340 mm), 8-1/2" x 13-1/2" (216 mm x 343 mm)

Custom Size Registration (Bypass)

Bypass tray and paper type settings are explained in this section.

If you frequently use a non-standard size paper in the bypass tray, register that paper size in advance.

Registering the paper size saves you the trouble of setting the size each time you need to use it.

Up to Seven paper sizes can be registered.

Tap the key ([Custom 1] to [Custom 7]) in which you wish to register or change a paper size, and the registration screen appears.

Select whether you wish to enter the inches ("Size Input-Inch") or size in mm ("Size Input-AB"), and then set the X and Y dimensions of the paper.

"Size Input-AB"

The X direction can be set between 140mm and 457mm. The factory default setting is 420mm.

The Y direction can be set between 90mm and 320mm. The factory default setting is 297mm.

"Size Input-Inch"

The X direction can be set between 5-1/2" and 18". The factory default setting is 17".

The Y direction can be set between 3-5/8" and 12-1/2". The factory default setting is 11".

Paper Type Registration

Store a paper type when the desired paper type does not appear as a selection or when you wish to create a new set of paper properties.

Up to 7 paper types can be registered.

List name	Description
Type Name	Register any name. The factory default names are "User Type 1" to "User Type 7".
Fixed Paper Side	Use this setting when paper with a front and reverse side is used.
Disable Duplex	Use this setting when paper loaded cannot be used for 2-sided printing.
Disable Reverse	Use this setting when using paper that cannot be reversed.
Disable Staple	Use this setting when paper used cannot be stapled.
Disable Punch	Use this setting when paper used cannot be punched.
Disable Fold	Use this setting when paper used cannot be punched.



The settings that can be selected vary depending on the peripheral devices installed.



Operation Settings

Condition Settings

Enlarge Display Mode

Displays large characters on the screen.

 appears in the system area when Large Character Mode is enabled.

Message Time Setting

The duration of time that messages appear in the touch panel (the time until a message is automatically cleared) can be set to any number of seconds from 1 to 12.

Language Setting

The language that appears in the touch panel can be changed to any language.



When user authentication is enabled and a display language is specified in the favourite operation group, that setting is given priority.

Default Display Setting

Set the screen that appears after auto clear and login.

You can select from Easy Copy, Copy, Easy Scan, E-mail, Network Folder, FTP/Desktop, Easy Fax, Internet Fax, Fax, Print Release, Data Entry, Address Book, Address Book (Easy Scan), Address Book (Easy Fax), Document Filing, Home Screen, Exchange (E-Mail), Gmail or the Sharp OSA Screen.

Display Favorite Menus as Default

You can specify to display the "Favorite" first during mode selection.

Display Action Panel as default.

Specify whether or not to display with the action panel on the screen.

Icon is displayed when LAN cable is not connected.

Show an icon when a LAN cable is not connected.

Display Confirmation Dialog when job is cancelled.

Show a confirmation dialog box when a job is cancelled.

Switch the Number of Sets to be Displayed for Job Status

Set whether the remaining number of sets or the final number of sets is shown in the job status.

Alignment Order of 10-Key

Set whether the numeric keys are arranged in ascending order with "1" in the upper left corner, or "1" in the lower left corner.

Setting Display from Main Unit

Select settings for the path information of the setting destination displayed when setting mode is set on the machine.

Display Current Path

Set whether or not the current setting items are shown in the path information.

Enable link of current path

Set whether the link at the top is enabled.

MFP Display Pattern Setting

Set the background colour of the touch panel. Each time you change patterns, the touch panel image at the bottom of the screen changes.



Key Operation Setting

Keys Touch Sound

Controls the key touch sound level, or turns the sound off.

Make Key Touch Sound at Default Setting

When you specify the exposure in the exposure adjustment screen of each mode, a bleep sounds three times when the reference value is reached.

Screen in which setting is effective	Initial value
Ratio setting screen in base screen of copy mode	Ratio 100%
Exposure setting screen in base screen of copy mode	Exposure level: 3 (medium)
Exposure adjustment screen in base screen of fax, Internet fax, and network scanner modes	
Exposure adjustment screen for Scan to HDD in document filing mode	

Auto Clear Setting

The time until Auto Clear activates can be set to any number of seconds from 10 to 240 in increments of 10 seconds. If the machine is not used for the duration of time set here, the auto clear function will clear any settings that have been selected and return the screen to the base screen of copy mode or the job status screen.

Cancel Timer

This is used to disable the auto clear function.

Key Operation Setting

Time for Accepting Key Entry

This setting determines how long a key in the touch panel must be tapped until the key input is registered. The time can be set from 0 to 2 seconds in increments of 0.5 seconds.

By lengthening the time setting, key input can be prevented when a key is tapped accidentally. Keep in mind, however, that when a longer setting is selected more care is required when tapping keys to ensure that key input is registered.

Disable Auto Key Repeat

This is used to disable key repeat.

Key repeat causes a setting to change continuously not only each time the key is tapped but while a key is tapped.

Time for Accepting Key Entry of Long Touch

Select a time when a long key touch is detected.

Double Tap Interval Setting

Select an interval when a double tap is detected.

Disabling of Job Priority Operation

The job priority function can be disabled. When this is done, the [Priority] key will not appear in the job status screen.

Disabling of Bypass Printing

This setting is used to disable bypass printing (printing other jobs ahead of a job that has been stopped* because the paper required for the job is not available in any of the trays).

* This does not include cases where the paper ran out during the job.

Disabling of Covers/Inserts Mode

Disables the use of the covers and inserts function.

Disable Printing of Operation Manual from the Operation Panel

Printing the manual from the operation guide embedded in the machine is prohibited.



Initial Original Count Setting

Specifies whether or not "Original Count" in Others is enabled for each function.

Copy

- Copy

Image Send

- Scan to
- Internet Fax
- Fax
- Data Entry

Document Filing

- Scan to HDD

Preview Setting

Received Data Image Check Setting

Select whether or not a preview of received faxes and Internet faxes is shown. This is displayed when a facsimile expansion kit or Internet fax expansion kit is installed.

Default List/Thumbnail Display

- Fax/I-Fax Reception Data: Select whether the default display format of the received fax/I-Fax list screen is list or thumbnails.
- File Retrieve of Main Folder/Quick File Folder: Select whether the default display format of the document filing main folder and temporary folder screens is list or thumbnails.
- File Retrieve of Custom Folder: Select whether the default display format of the document filing custom folder screen is list or thumbnails.
- File Retrieve of Direct Print: Select whether the default state of the folder screen for direct print shows the folders as a list or as thumbnails.

Remote Operation Settings

Configure settings required for remote operation of the machine from a PC connected to the same network.

Remote Software Operation

- Operational Authority: This is used when remote software is used to operate the machine remotely.
- View Password Entry Screen: When operating the machine by remote control using the remote software, the password entry screen will appear on both the computer and the machine, or on only the computer.

Operation from Specified PC

- Operational Authority: This is used to allow remote operation of the machine using the specified PC.
- Hostname or IP Address of PC: Enter the host name or IP address of the PC to be connected to the machine.
- View Password Entry Screen: When operating the machine by remote control using the remote software, the password entry screen will appear on both the computer and the machine, or on only the computer.

Operation by User who Has Password

- Operational Authority: This is used to allow a user who has a password to operate the machine remotely. For information on the password, consult your service technician.
- View Password Entry Screen: When operating the machine by remote control using the remote software, the password entry screen will appear on both the computer and the machine, or on only the computer.



Easy Mode Settings

Set the items that can be selected in Easy Copy and other Easy modes.

The items appear will appear in order on the screen starting from the item that is set in No. 1.

Items that can be set in Easy Copy

Paper Select, 2-Sided Copy, Copy Ratio, Staple / Punch, Colour Mode, Image Orientation, Exposure and N-Up, Card Shot

Items that can be set in Easy Scan

Address Book, History, Global Address Search, Scan to HDD/USB, Original, Resolution, File Format, Blank Page Skip and Card Shot.

Items that can be set in Easy Fax

Address Book, History, Direct Entry, Original, Exposure and Resolution.



The items that can be set vary depending on the peripheral devices that are installed.

Favorite Key Setting

Set the information that appears when favourite keys are tapped in normal mode.

Click the Copy, Scan, Internet Fax, Fax, and Data Entry tabs to configure settings for the favourite key screens shown in each of the normal modes.

Favorite Key Number

Sets the favourite key number.

The items appear will appear in order on the screen starting from the item that is set in No. 1.

Key Name

Enter a maximum of 20 characters for the favourite key name.

Function Menu

To set functions such as "Other Functions", select the functions from the pull-down menu.

Job Programs

To set a program, select one of the preset programs from the program list.

Not Display

You can hide a set key in the favourite key screen.

Mode Key Display Setting

Configure settings for the display of mode keys at the top of the screen.

Modes to Display

Select the mode keys that you want to display.

Display Mode Keys on Home

You can enable display of the mode keys in the home screen as well.



Keyboard Settings

Default Keyboard Setting

Configure settings for the keyboard used for entry on the text.

Keyboard Select

Change the key layout and display according to the set language.

Set Keyboard Priority

When an external keyboard is connected, set whether the external keyboard or the keyboard shown on the touch panel (soft keyboard) is given priority.

Soft Keyboard Template Setting

Register a text that you frequently use when entering an address or domain name in advance. Enter a maximum of 16 characters.



Device Control

Various devices mounted on the machine can be set.

Original Size Detector Setting

One of the 8 groups of standard original sizes shown below can be selected for detection by the original size detection function.

Selections	Detectable original sizes	
	Document glass	Document feeder tray (automatic document feeder)
AB-1	A3, A4, A4R, A5, B4, B5, B5R	11" x 17", 8-1/2" x 14", 8-1/2" x 11", A3, A4, A4R, A5, B4, B5, B5R
AB-2	A3, A4, A4R, A5, B5, B5R, 216 mm x 330 mm (8-1/2" x 13")	A3, A4, A4R, A5, B4, B5, B5R, 11"x17", 8-1/2"x11", 216 mm x 330 mm (8-1/2"x13")
AB-3	A4, A4R, A5, B4, 8K, 16K, 16KR	A3, A4, A4R, A5, B4, 11"x17", 8-1/2"x11", 216 mm x 330 mm (8-1/2"x13"), 8K, 16K, 16KR
AB-4	216 mm x 340 mm (8-1/2" x 13-2/5"), A3, A4, A4R, A5, B5, B5R	A3, A4, A4R, A5, B4, B5, B5R, 11"x17", 8-1/2"x11", 216 mm x 340 mm (8-1/2"x13-2/5")
AB-5	216 mm x 343 mm (8-1/2" x 13-1/2"), A3, A4, A4R, A5, B5, B5R	A3, A4, A4R, A5, B4, B5, B5R, 11"x17", 8-1/2"x11", 216 mm x 343 mm (8-1/2"x13-1/2")
Inch-1	11" x 17", 8-1/2" x 14", 8-1/2" x 11", 8-1/2" x 11"R, 5-1/2" x 8-1/2"	11" x 17", 8-1/2" x 14", 8-1/2" x 11", 8-1/2" x 11"R, 5-1/2" x 8-1/2", A3, A4
Inch-2	11" x 17", 216 mm x 330 mm (8-1/2" x 13"), 8-1/2" x 11", 8-1/2" x 11"R, 5-1/2" x 8-1/2"	11"x17", 216 mm x 330 mm (8-1/2"x13"), 8-1/2"x11", 8-1/2"x11"R, 5-1/2"x8-1/2", A3, A4
Inch-3	11" x 17", 8-1/2" x 13-2/5" (216 mm x 340 mm), 8-1/2" x 11", 8-1/2" x 11"R, 5-1/2" x 8-1/2"	11"x17", 8-1/2"x13-2/5" (216 mm x 340 mm), 8-1/2"x11", 8-1/2"x11"R, 5-1/2"x8-1/2", A3, A4

Cancel Detection at Document Glass

Original size detection on the document glass can be disabled. When this is done, all originals placed on the document glass are treated as special size originals.

Original Feeding Mode

The following original feeding modes can be set to operate by default in copy, image send, and scan to HDD. When a mode is frequently used, this saves you from having to select the mode in another mode each time you need to use it.

- Mixed Size Doc. Different Width
- Slow Scan Mode
- Blank Page Skip*

* Excluding fax mode and Internet fax mode.

Paper Type for Auto Paper Selection

The paper types* that the Auto Paper Selection function will select can be specified. Select one of the following settings:

- Plain
- Plain and Recycle Paper
- Recycled

The Auto Paper Selection function will not select any paper types other than the paper types specified with this setting.

* The paper type set for each paper tray by selecting [System Settings] in "Settings" → [Paper Tray Settings].



Tandem Connection Setting

When two machines are used as network printers using TCP/IP protocol, use this setting to configure the port number and IP address of the machine used as the tandem client machine.

Disabling of Master Machine Mode

To prohibit tandem transmission, enable this setting. (Normally this setting is not necessary.)

Disabling of Client Machine Mode

To prohibit tandem reception, enable this setting. (Normally this setting is not necessary.)



- To use the tandem function when user authentication is enabled, the same login name and password must be used on both the master machine and client machine. If the same login name and password are not used, the page count may not be added to the appropriate user count or only the master machine may print.
- The factory default setting for the port number is [50001]. Unless you experience difficulty with this setting, do not change the port number.

Detect Standard in Auto Colour Mode

When the colour mode is set to auto in copy mode, the discrimination point for detecting whether originals are colour or black and white can be set to one of 5 levels. When set to [Closer to B/W], the originals are easier to recognize as black and white. When set to [Closer colour], the originals are easier to recognize as black and white.

Data Indicator Setting

Set the operation of the fax reception / data indicator light. For details, refer to "[DATA NOTIFICATION INDICATOR AND ERROR INDICATOR \(page 1-9\)](#)".

Status Indicator will blink if data is received

Set whether or not the fax reception / data indicator light blinks when a fax has been received.

Error Light Setting

Set the operation of the error indicator light. For details, refer to "[DATA NOTIFICATION INDICATOR AND ERROR INDICATOR \(page 1-9\)](#)".

Total Setting for Finish

Select the finish setting. Set whether finishing positions are specified on the specified paper or on the original.

Plain Paper Weight Settings

These are used to control the toner fusing temperature according to the weight of the paper.

These settings apply to plain paper, recycled paper, punched paper, pre-printed paper, letterhead paper, coloured paper, and user type paper.

You can select "60g/m² to 89g/m²" or "90g/m² to 105g/m²" ("16 to 23 lbs." or "23+ to 28 lbs.").



This can only be set on the machine's operation panel.

Be sure to use only paper that is in the same weight range as the weight range set here. Do not mix plain or other paper that is outside the range with the paper in the tray.

When settings are changed, the changes will take effect after the machine is restarted. To restart the machine, see "[TURNING ON THE POWER \(page 1-10\)](#)".

Data List

To specify [One Sided] or [Two Sided] printing in Data List.

Disabling of Duplex

This is used to disable 2-sided printing, such as when the duplex module malfunctions.

Disabling of Offset

Disable offset output.

Disabling of Document Feeder

Use this setting to prohibit the use of the automatic document feeder, such as when the feeder malfunctions. (When the setting is enabled, scanning is still possible using the document glass.)



Disabling of Large Capacity Cassette

This setting is used to disable the large capacity cassette, such as when it malfunctions.

Disabling of Optional Paper Drawer

This setting is used to disable the optional paper drawer, such as when it malfunctions.

Disabling of Tray Settings

This setting is used to prohibit tray settings (except for the bypass tray).

Disabling of Finisher

This setting is used to prohibit the use of finisher or saddle finisher, such as when it malfunctions.

Disabling of Stapler

This setting is used to prohibit the use of staple, such as when the staple of finisher or saddle finisher malfunctions.

Disabling of Punch

This setting is used to prohibit the use of punch, such as when the punch module of finisher or saddle finisher malfunctions.



Enable/Disable Settings

The following settings enables or disables certain functions.

User Control

Disable Printing by Invalid User

Printing by users whose information is not stored in the machine, such as printing without entering valid user information in the printer driver or printing of a file on an FTP server in Setting mode (Web version), can be prohibited.

Copy Function Settings

Disabling of Registration/Deletion of Program

This is used to prohibit the deletion and changing of copy settings stored in job programs.

Disabling of Bypass-Tray in Duplex Copy

Disables the use of the bypass tray when making 2-sided copies.

The bypass tray is often used to feed label sheets, transparency film, and other special media for which 2-sided copying is prohibited. If a sheet of one of these special media enters the reversing unit, a misfeed or damage to the unit may result. If special media for which 2-sided copying is prohibited is often used, it is recommended that you enable this setting.

Disabling of Auto Paper Selection

Disables the Auto Paper Selection function.

When this setting is enabled, automatic selection of paper that is the same size as the original on the document glass or in the automatic document feeder does not take place.

Disabling Registration of Custom Image

Disables storage of a custom image.

Disabling sending while copying

Disables the Image Send function during copy.

Printer Settings

Prohibit Notice Page Printing

Disables to print a notice page.

Prohibit Test Page Printing

Disables to print the test page.

When this setting is enabled, [Status] → [Data List] → [List for User] → [Printer Test Page] in "Settings" cannot be used to print test pages.

Exclude Bypass-Tray from Auto Paper Select

When [Auto] is selected for paper type selection, the bypass tray is excluded from the trays that can be selected. This is recommended when special paper is often placed in the bypass tray.

Disabling of USB Memory Direct Print

Disables the function for directly printing of a file in a USB memory device.

Disabling of Network Folder Direct Print

Disables the direct printing from a network folder.

Disabling sending while printing

Disables the Image Send function during printing.

Disable Blank Page Print

Disables to print a blank page.



Image Send Settings

Disable Switching of Display Order

Disables a change of display sequence (search number order, ascending, descending) in the address book and others. If set, the display is not sorted even when you tap the tab on the address book screen. The currently selected display order will be the order that is used after the setting is selected.

Disable Fax Broadcasting

Disables the facsimile broadcasting.

Disable Scan Function

Specify this to disable remote PC scanning and storing to external memory device.

Settings to Disable Registration

Disable Registering Destination from Operation Panel

Disables address control from the machine.

Configure the setting for each of the following items:

- Group (Direct Entry)
- Group (Address Book)
- Contacts

Select All: Selects all items.

Clear Checked: Clears all selections.

Disable Registering Destination on Web Page

Disables to store the destination from Setting mode (Web version).

Configure the setting for each of the following items:

- Group (Direct Entry)
- Group (Address Book)
- Contacts

Select All: Selects all items.

Clear Checked: Clears all selections.

Disable Registration/Deletion of All Program Items

Disables the use of address book when a program is stored.

Disable Registration of Memory Box

Disables all types of memory box registration.

Configure the setting for each of the following items:

Polling Memory, Confidential, Relay Broadcast (Direct Entry), Relay Broadcast (Address Book)

Disable Destination Registration Using Global Address Search

This disables address control from the global address search.

Configure the setting for each of the following items:

E-mail, Internet Fax, Fax

Disable Registration Using Network Scanner Tool

This disables address control from the Network Scanner Tools.

Disabling of Forwarding via Network

This prohibits inbound routing.

Settings to Disable Transmission

These settings are used to disable the following transmission operations.

Disable [Resend] on Fax/Image Send Mode

This setting disables the [Resend] key in the base screen of image send mode.

**Disable Selection from Address Book**

Disables the selection of destinations from the address book.

Configure the setting for each of the following items:

- E-mail
- FTP
- Internet Fax (Including Direct SMTP)
- Fax
- Desktop
- Network Folder

Select All: Selects all items.

Clear Checked: Clears all selections.

Disable Direct Entry

Disables the direct entry of destination address and others.

Configure the setting for each of the following items:

- E-mail
- Network Folder
- Internet Fax (Including Direct SMTP)
- Fax

Select All: Selects all items.

Clear Checked: Clears all selections.

Disabling of PC Scan

Prohibit remote PC scan.

Disable Storing to External Memory Device

Prohibit saving to an external memory device.

Disable PC-I-Fax Transmission

This prohibits PC-I-Fax transmission.

Disable PC-Fax Transmission

This prohibits PC-Fax transmission.

Disabling of Find My Address

This prohibits Find My Address.

Document Filing Settings

Disable Text/Stamp functions for Reprinting

When a stored file is retrieved and printed, the printing functions are disabled.

This function prevents an inconsistency of the date between the original data and output data and others.

Batch Print Settings

When files are printed by batch printing, you can prohibit selection of the [All Users] key and [User Unknown] key in the user selection screen, and set whether the file order is by date from the newest date or oldest date, or by file name in ascending order or descending order.



The Enable/Disable Settings control the same parameters as the enable/disable settings in other settings. The settings are linked together (changing one setting changes the other).



Operation Settings

Cancel Auto Clear Timer

Disables the Auto Clear mode.

Disabling of Job Priority Operation

The job priority function can be disabled. If disabled, the [Priority] key is not shown on the job status screen.

Disabling of Bypass Printing

Disables bypass printing (printing other jobs ahead of a job that has been stopped* because the paper required for the job is not in any of the trays).

* This option is ignored when paper runs out during the job.

Disable Auto Key Repeat

Disables the Auto Key Repeat function.

Disabling of Clock Adjustment

Disables the date and time from being changed.

Disabling of Covers/Inserts Mode

Disables the use of the covers and inserts function.

Disable Printing of Operation Manual from the Operation Panel

Printing the manual from the operation guide embedded in the machine is prohibited.

Device Control

Disabling of Document Feeder

Use this setting to prohibit the use of the automatic document feeder, such as when the feeder malfunctions. (When the setting is enabled, scanning is still possible using the document glass.)

Disabling of Duplex

This is used to disable 2-sided printing, such as when the duplex module malfunctions.

Disabling of Large Capacity Cassette

This setting is used to disable the large capacity cassette, such as when it malfunctions.

Disabling of Optional Paper Drawer

This setting is used to disable the optional paper drawer, such as when it malfunctions.

Disabling of Tray Settings

This setting is used to prohibit tray settings (except for the bypass tray).

Disabling of Finisher

This setting is used to prohibit the use of finisher or saddle finisher, such as when it malfunctions.

Disabling of Offset

Disable offset output.

Disabling of Stapler

This setting is used to prohibit the use of staple, such as when the staple of finisher or saddle finisher malfunctions.

Disabling of Punch

This setting is used to prohibit the use of the folding unit.

Disabling of Master Machine Mode

Disables the Master Machine mode for tandem printing.
(Normally this setting is not necessary.)



Disabling of Client Machine Mode

Disables the Client Machine mode for tandem printing.
(Normally this setting is not necessary.)

Security Settings

This setting is used to set the security enhancement functions.

Hidden Pattern Print Setting

Disables the direct entry of background pattern and others.

Machine Identification Settings

Enter a name or code to identify the machine.



Clock Adjust

This is the first and basic setting for operating the machine.
Use this to set the date and time in the machine's built-in clock.



If [System Settings] in "Settings (administrator)" → [Common Settings] → [Enable/Disable Settings] → [Disabling of Clock Adjustment] is enabled, the date and time cannot be set.

Item	Description
Specify Time Zone	If your region is ahead of GMT (Greenwich Mean Time), select [+]. If your region is behind GMT, select [-]. Next, specify the time difference between your region and GMT in hours and minutes. (Example: If your region is Japan, + 9 hours 00 minutes.)
Date&Time Settings	Select and set the year, month, day, hour, and minute.
Synchronize with Internet Time Server	This can be used when the machine is connected to the Internet. The machine's time is automatically adjusted to the time of an Internet time server.

Daylight Saving Time Setting

This is the first and basic setting for operating the machine.
Enable daylight saving time.



If [System Settings] in "Settings (administrator)" → [Common Settings] → [Enable/Disable Settings] → [Disabling of Clock Adjustment] is enabled, the date and time cannot be set.

Item	Description
Daylight Saving Time Setting	Select whether or not the Daylight Saving Time Setting is enabled. If disabled, the following settings will not be possible.
Select Setting Type	Specify whether the starting and ending day of daylight saving time are to be set using the day of the week or the date.
Start Time	Set the starting time of daylight saving time. If you selected "Day of the Week" in "Select Setting Type", set the starting week of daylight saving time and then the starting day. If you selected "Date" in "Select Setting Type", set the starting date. Set the hour and minute and the UTC (Coordinated Universal Time) setting.
End Time	Set the ending time of daylight saving time in the same way as you set the starting time.
Adjustment Time	Set the time to be adjusted when daylight saving time begins.

When this function is used, the time changes at the beginning and end of daylight saving time as indicated in the table below.

Area	Standard time → Daylight saving time	Daylight saving time → Standard time
Europe*	Last Sunday in March, 1:00 to 2:00 AM	Last Sunday in October, 1:00 to 0:00 AM
Australia, New Zealand	Last Sunday in October, 2:00 to 3:00 AM	Last Sunday in March 3:00 to 2:00 AM
Other countries	Select the [Daylight Saving Time Setting] checkbox so that a checkmark <input checked="" type="checkbox"/> appears. The clock setting is configured to normal time plus one hour. When the <input checked="" type="checkbox"/> is selected, clock returns to normal time.	

* In some countries, the starting and ending times of daylight saving time may be different than the times set in the machine.



Date Format

This is the first and basic setting for operating the machine.
The format used to print the date on lists and other output can be changed.



If [System Settings] in "Settings (administrator)" → [Common Settings] → [Enable/Disable Settings] → [Disabling of Clock Adjustment] is enabled, the date and time cannot be set.

Item	Description
Current Setting	The current time appears in the format set in Date Format.
Format	Set the order of display of the year, month, and day (YYYY/MM/DD).
Separator	Select one of three symbols or a blank space for the separator used in the date.
Day-Name Position	Select whether the day name appears before or after the date.
Time Display	Select 12-hour format or 24-hour format for the time. 24-Hour Display: 00:00 to 24:00 12-Hour Display: 00:00 AM to 11:59 AM/00:00 PM to 11:59 PM

Product Key

You must enter the machine product key to use the following advanced functions.

Serial Number

This displays the serial number that is required to obtain the product key.

Font Kit for Barcode

Enter the product key of the barcode font kit.

Internet Fax Expansion Kit

Enter the product key of the Internet Fax Expansion Kit.

Application Integration Module

Enter the product key of the application integration module.

Direct Print Expansion Kit (MX-2630N/MX-3050V/MX-3550V/MX-4050V/MX-5050V/MX-6050V only)

Enter the product key of the Direct Print Expansion Kit

Application Communication Module

Enter the product key of the application communication module.

External Account Module

Enter the product key of the external account module.



- It may not be possible to use some settings, depending on the peripheral devices installed.
- For the product key to be entered, contact your dealer.
- This setting cannot be specified in some countries and regions.

Custom Link Setting

The stored Web addresses can be displayed in the display area of the setting menu.
Click a custom link to jump to the website of the stored address.



Network Settings

Quick Settings

Select the minimum required settings for the machine connection to the network.

Wireless Settings

Connection Type

Use this setting to switch between [Wired Only], [Wired+Wireless (Access Point Mode)] or [Wireless (Infrastructure Mode)].

When "Wireless (Infrastructure Mode)" is selected in "Connection Type"

Access Point Search

Click this to search access points. When the search results are displayed, select the access point to use and click [OK]. [SSID], [Security Type], and [Encry.] are automatically applied.

SSID

Enter an SSID using up to 32 characters.

Security Type

Select a security type.

Encry.

Select an encryption type.

Security Key

Enter a security key.

Security Type	Security Key
<ul style="list-style-type: none"> • WEP • WPA/WPA2-mixed Personal • WPA/WPA2-mixed Enterprise • WPA2 Personal • WPA2 Enterprise 	<p>WEP64bit: 5 characters or 10-digit hexadecimal number</p> <p>WEP128bit: 13 characters or 26-digit hexadecimal number</p> <p>WPA/WPA2: 8 to 63 characters or 64-digit hexadecimal number</p>

Show Security Key

If it is set to ON, the security key appears.

IPv4 Settings

When using the machine on a TCP/IP (IPv4) network, use this setting to configure the IP address of the machine.

DHCP

Use this setting to have the IP address obtained automatically using DHCP (Dynamic Host Configuration Protocol)/BOOTP (Bootstrap Protocol). When this setting is enabled, it is not necessary to manually enter an IP address.



- If DHCP/BOOTP is used, the IP address assigned to the machine may change automatically. If the IP address changes, printing will not be possible.
- If the machine is used on a TCP/IP network, be sure to enable the "[TCP/IP \(page 7-140\)](#)" below.

IPv4 Address

Enter the IP address of the machine.

Subnet Mask

Enter the IP subnet mask.

Default Gateway

Enter the default gateway address.



DNS Settings

Primary Server

Enter the IP address of primary DNS server.

Secondary Server

Enter the IP address of secondary DNS server.

Domain Name

Enter the domain name where the selected DNS server exists.

SMTP Settings

Primary Server

Enter the IP address or the host name of the primary SMTP server.

Sender Name

Enter the sender name.

Sender Address

If data transmission has failed, the undelivered e-mail may be returned from the server. Enter an e-mail address (a single address only) to receive such undelivered mails. Usually, enter the e-mail address of system administrator.

Enable SSL

If is selected, the SMTP-over-TLS encryption communication can be used by STARTTLS command. This requires the server to support the STARTTLS command.

To allow SSL communication, set the "Port Number" to the same port number as the normal SMTP.

SMTP Authentication

If is set, the SMTP server authentication is carried out.

User Name

Enter the user name.

Password

Enter the password.

Change Password

To change the password, set .

Connection Test

Tap the [Execute] button to test the connection to the SMTP server.

LDAP Settings

Name

Enter the address book name.

Search Root

Enters the search defaults to search for a specific area of the LDAP directory information tree.

Example: o = ABC, ou = NY, cn = Everyone

Entries must be separated from each other by semicolons or commas.



LDAP Server

Enter the IP address or host name of the LDAP server.

User Name

Enter the account name for LDAP setting.

Password

Enter the password.

Change Password

To change the password, set .

Authentication Type

Select the authentication server from the drop-down list.

KDC Server

Enter the IP address or host name of the Kerberos authentication server.

Realm

Enter the Kerberos realm.

Allow selection on operation panel.

Specify whether or not enable the global address to be selected on the operation panel of the machine.

Authenticate a User in Global Address Search

Select whether or not authenticate a user when a global address is searched for.

Enable SSL

If is set, the SSL encryption communication is enabled.

Connection Test

Tap the [Execute] button to test the connection to the LDAP server.

Public Folder / NAS Setting

Set each option to [Prohibited] if the storage is not used.



When settings are changed, the changes will take effect after the machine is restarted. To restart the machine, see "[TURNING ON THE POWER \(page 1-10\)](#)".

Network Name Setting

Device Name

Enter a device name.

Domain Name

Enter the domain name.

Comment

Enter a comment.



Protocol Settings

Select the general network settings.
The TCP/IP information can be set.

TCP/IP

IPv4 Settings

When using the machine on a TCP/IP (IPv4) network, use this setting to configure the IP address of the machine.

DHCP

Use this setting to have the IP address obtained automatically using DHCP (Dynamic Host Configuration Protocol) v6.
When this setting is enabled, it is not necessary to manually enter an IP address.



If DHCP/BOOTP is used, the IP address assigned to the machine may change automatically. If the IP address changes, printing will not be possible.

IPv4 Address

Enter the IP address of the machine.

Subnet Mask

Enter the IP subnet mask.

Default Gateway

Enter the default gateway address.

IPv6 Settings

When using the machine on a TCP/IP (IPv6) network, use this setting to configure the IP address of the machine.

IPv6

Enable this setting.

DHCPv6

Use this setting to have the IP address obtained automatically using DHCP (Dynamic Host Configuration Protocol) v6.
When this setting is enabled, it is not necessary to manually enter an IP address.

Manual Address / Prefix Length

Enter the IP address and the prefix length (0 to 128) of the machine.

Default Gateway

Enter the default gateway address.



- If DHCPv6 is used, the IP address assigned to the machine may change automatically. If the IP address changes, printing will not be possible.
- In an IPv6 environment, the machine can use LPD or IPP protocol.

MTU Settings

Set the maximum data size that can be forwarded.

SMB Settings

Set the version of SMB protocol that is used for functions such as Scan to Network Folder.

Use this setting to connect to a device that cannot automatically change the SMB protocol version, or when there is a problem in the connection with another device due to different versions.

Set the version to SMB2.0, SMB2.1, or SMB3.0.



- One of the settings is SMB1.0, however, this is always enabled and cannot be disabled.
- When a version is disabled, version settings higher than that version are all disabled. When a version is enabled, all version settings lower than that version are enabled.

Ping Command

Checks if the machine can communicate with the PC of the network.

Specify the IP address of the desired PC and tap the [Execute] key. A message indicating a response by the PC or not is displayed.



Services Settings

Select the general network settings.

Select the DNS, SMTP, Kerberos authentication, SNTP, mDNS, SNMP, and WINS settings.

DNS

DNS Settings

IPv4 Settings

Primary Server

Enter the IP address of primary DNS server.

Secondary Server

Enter the IP address of secondary DNS server.

IPv6 Settings

Primary Server

Enter the IP address of primary DNS server.

Secondary Server

Enter the IP address of secondary DNS server.

Timeout

Enter a timeout. The default setting is 2 seconds.

This time is used until the connection to the DNS server is established according to the standard specifications.

Domain Name

Enter the domain name where the selected DNS server exists.

DNS Update

Set this option to use the dynamic updating of DNS server.

Update Interval

Enter an interval to update the DNS server.

SMTP

SMTP Settings

Primary Server

Enter the IP address or the host name of the primary SMTP server.

Secondary Server

Enter the IP address or the host name of the secondary SMTP server.

Port Number

Enter a port number. The default setting is port 25.

Timeout

Enter a timeout. The default setting is 20 seconds. This value is used for connection to the SMTP server and for data transmission according to the e-mail system specifications.

Sender Name

Enter a maximum of 20 full-width/half-width characters for the sender name.

Sender Address

Enter a maximum of 64 half-width characters for the sender address.

Enable SSL

If the SSL is enabled, the SMTP-over-TLS encryption communication can be used by STARTTLS command.

This requires the server to support the STARTTLS command.

To allow SSL communication, set the "Port Number" to the same port number as the normal SMTP.

SMTP Authentication

Carries out the SMTP server authentication.

If you use the Kerberos authentication, set the KDC server, port number, and realm on the Kerberos authentication settings page.

User Name

Enter the user name.



Password

Enter the password.

To change the password, set [Change Password] to .

POP before SMTP

If is set, you are authenticated to the POP server before using the SMTP communication.

- POP3 Server: Enter the IP address or the host name of the secondary SMTP server.
- Port Number: Enter the POP3 port number for POP before SMTP communication. The default setting is port 110.
- POP Authentication: If is set, the authentication protocol (including APOP) is used for authentication to the POP3 server.
- User Name: Enter the user name for POP before SMTP communication.
- Password: Enter the password required for POP before SMTP communication. To change the password, set [Change Password] to .
- Enable SSL: If set to , the POP over SSL communication or the POP over TLS communication by STLS command is enabled.

This requires the server to support the POP over SSL communication or the STLS command.

To allow SSL communication, set the "Port Number" to the POP over SSL communication port number.

To allow POP over TLS communication, set the "Port Number" to the same port number as for the normal POP3 communication.

Connection Test

Tap the [Execute] button to test the connection to the SMTP server.

Kerberos

Kerberos Authentication Settings

KDC Server

Enter the IP address or host name of the Kerberos authentication server.

Port Number

Enter the port number of the Kerberos authentication server. The default setting is port 88.

Realm

Enter the Kerberos realm.

SNTP

SNTP Settings

SNTP

Set this option to use the SNTP protocol.

SNTP Server

Enter the IP address or host name of the SNTP server.

Port Number

Enter a port number. The default setting is port 123.

Timeout

Enter a timeout. The default setting is 5 seconds.

Synchronous Interval

Enter an interval to synchronize to the SNTP server.

Synchronize Upon Start

To establish synchronization during machine startup, set to .

Synchronize Now

When tapped, the machine is synchronized with the SNTP server time.



mDNS

mDNS Settings

mDNS

Set this option to use the mDNS settings.

Service Name

Enter a service name.

Domain Name

Display the domain name.

Highest Priority Service

Select a service you use with the priority.

SNMP

SNMP v1 Settings

SNMP v1 Settings

Set this option to use the SNMPv1 settings.

Access Method

Set an access method.

GET Community

Enter the GET community name to fetch the device information using SNMP.

SET Community

Enter the SET community name required for SNMP setting.

Change SET Community

To change the SET community, set .

TRAP Community

Enter the community name to be used for the SNMP TRAP sent from the device.

TRAP Target Address

Enter the IP address of the destination computer for SNMP TRAP communication.

SNMP v3 Settings

SNMP v3 Settings

Set this option to use the SNMPv3 settings.

User Name

Enter the user name.

Authentication Key

Enter the authentication key.

Privacy Key

Enter the privacy key.

Context Name

Display the context name.

WINS

WINS Settings

Primary Server

Enter the IP address of primary WINS server.

Secondary Server

Enter the IP address of secondary WINS server.

Scope ID

Enter the scope ID.



Print Port Settings

LPD

Enter a profile expiring date.

LPD Settings

LPD

Set this option to use LPD.

Timeout

Enter a timeout. The default setting is 90 seconds.

Use Banner

Set this option to use the banner. The default setting is "Invalid".

RAW

Raw Print Settings

Raw Print

Set this option to use RAW printing. The default setting is "Valid".

Port Number

Enter a port number. The default setting is port 9100.

Timeout

Enter a timeout. The default setting is 90 seconds.

Use Bidirectional

To use bidirectional communication, set to .

WSD

WSD Settings

WSD Print

Set this option to use WSD printing.

Use Multicast Discovery

Set this option to use multicast discovery.

External Print Services Settings

Google Cloud Print Settings

Google Cloud Print

Specify whether or not Google Cloud Print is used.

Status

"Not Set", "Registering", "Registered", or "Offline" will appear.

Always Retain Prints

The retention print function can be enabled in Google Cloud Print.

When this setting is enabled, Google Cloud Print jobs are saved in the "Main Folder" of the document filing function of the machine.

When this setting is disabled, the machine starts printing immediately after it receives a Google Cloud Print job.

E-mail

This shows the e-mail address of the Google account of the administrator who registered the machine in Google Cloud Print.

Device Name

Set the device name that appears on the client device.

This setting is the same as the device name on the machine information page of the status.



Register with Google Cloud Print

This appears when the "Status" is "Not Set".

Tap this key to show the registration information on the operation panel.

Open the Web browser on your device and go to the URL that is displayed.

When the Google account login page appears in your Web browser, enter the Google account information of the administrator of the machine.

Follow the instructions that appear after you log in to complete the registration procedure for the machine.

When you have successfully completed registration, the "Status" changes to "Registered".



Complete the registration procedure within 10 minutes after the registration information is shown. If you fail to complete registration within this time, the status will change from "Registering" back to "Not Set".

Delete from Google Cloud Print

This appears when the "Status" is "Registered".

Tap this key to delete the machine's information from the Cloud server, and the Google Cloud Print settings from the machine.

Registration URL/QR code

This appears when the "Status" is "Registering".

Directly enter the URL for registration in the client device, or scan the QR code and access the registration page.

When you complete final registration on the registration page, you will be able to use Google Cloud Print.

AirPrint Settings

AirPrint (Print), AirPrint (Scan), AirPrint (Fax Send)

Select these settings to use the AirPrint functions.

mDNS

Enable or disable mDNS. When mDNS is disabled, the machine will not appear in the list of printers when AirPrint is used to print.

This setting is linked to [Network Settings] → [Services Settings] → [mDNS Settings] → [mDNS] in "Settings (administrator)".

IPP

Specify whether or not the IPP port of the machine is enabled. This setting is linked to [Security Settings] → [Port Control] → [IPP] in "Settings (administrator)".

IPP-SSL

Specify whether or not the IPP-SSL port of the machine is enabled. This setting is linked to [Security Settings] → [Port Control] → [IPP-SSL] in "Settings (administrator)".

Service Name

Set the name of the printer that appears in the application when AirPrint is used.

This setting is linked to [Network Settings] → [Services Settings] → [mDNS Settings] → [Service Name] in "Settings (administrator)".

Machine Location

Enter the machine installation location information that is sent to the application when AirPrint is used.

This setting is linked to Machine Information Page in Setting mode.

geo URI (RFC 5870)

Enter the geographic location of the machine.

Enter the location information in the format specified by the geo URI standard.



External Service Connect

Cloud Connect Settings

Office 365

Domain Name

Set this when using the OneDrive for Business Link / SharePoint Online Link function.
Enter your Office 365 domain name (the ***** part of *****.onmicrosoft.com).

SharePoint Online

Site URL

To connect to a subsite or site collection of the SharePoint Online server, enter the URL.

Google Drive

Google Drive

Specify whether or not the Google Drive is enabled.

E-mail Connect Settings

Exchange

Exchange

To enable Exchange, select using the Enable/Disable pull-down.

Hostname

Enter the host name (FQDN) of the Exchange server.

Use Exchange Online

To connect to Exchange Online, set this to .

Gmail

Gmail

To enable Gmail, select using the Enable/Disable pull-down.



LDAP Settings

The following explains the LDAP settings.

When you tap the [Store] key, the LDAP settings are updated with your entries.

The default address book is set to .

Add

Tap the [Add] key for addition.

Delete

To delete an item, select it and tap the [Delete] key.

Settings

Setup Items	Setting
Name	Enter the address book name.
Search Root	Enters the search defaults to search for a specific area of the LDAP directory information tree. Example: o = ABC, ou = NY, cn = Everyone Entries must be separated from each other by semicolons or commas.
LDAP Server	Enter the IP address or host name of the LDAP server.
Server Type	Select the Default or Custom from the service type list. The default setting is Default.
User Identity Attribute	Set the user ID property. The default setting is "uid".
Search Attribute	Set the LDAP search property. The default setting is "cn".
Obtain E-mail address from	Set the e-mail address search. The default setting is "mail".
Obtain Internet Fax address from	Set the Internet Fax address search. The default setting is "mail".
Obtain Fax number from	Set the fax number search. The default setting is "facsimileTelephoneNumber".
Public Key Search	Sets the open key search. The default setting is "userCertificate".
Pages Limit Group	Set the Storing Page Limit Group Search. The default setting is "pagelimit".
Authority Group	Set the Storing Authority Group Search. The default setting is "authority".
Favourite Operation Group	Set the Favourite Operation Group Search. The default setting is "favourite".
My Folder	Set the My Folder Search. The default setting is "myfolder".
Card ID	Sets the card ID search. The default setting is "cardid".
Custom Property 1-10	Enter each custom property.
Port Number	Enter a port number. The default setting is port 389.
Timeout	Enter a timeout. The default setting is 5 seconds.
User Name	Enter the account name for LDAP setting.
Password	Enter the password. To change the password, set [Change Password] to <input checked="" type="checkbox"/> .
Authentication Type	Select the authentication server from the drop-down list.
Bind Prefix	Set the Bind prefix. The default setting is "uid".
Server Usage	Set the server application. Set the address book and user authentication.
Applicable Destination Type	Select the applicable destination type from E-mail Address, Fax Number, and Internet Fax.
Allow selection on operation panel.	Specify whether or not enable the global address to be selected on the operation panel of the machine.
To Be Used as Default	Specify whether or not to use the selected global address as default.
Authenticate a User in Global Address Search	Select whether or not authenticate a user when a global address is searched for.
Enable SSL	Enables the SSL encryption communication.
Connection Test	Tap the [Execute] button, and the connection test is executed and its result is displayed.



When settings are changed, the changes will take effect after the machine is restarted. To restart the machine, see "[TURNING ON THE POWER \(page 1-10\)](#)".



Active Directory Settings

Domain Name

Enter the domain name.

Search Attribute:

Set the lookup attribute. The default setting is cn.

Linkage with User Control Function

Pages Limit Group

Enter to set a page limit group. The default setting is pagelimit.

Authority Group

Enter to set an authority group. The default setting is authority.

Favourite Operation Group

Enter to set a favourite operation group. The default setting is favorite.

My Folder

Enter to set My Folder. The default setting is myfolder.

Device Registration Account

User Name

Enter the user name to be used.

Password

Enter a password.

Public Folder / NAS Setting

The "public", "shared" and "faxreceive" folders of the MFP can be accessed as network folders from a network PC.

Settings

Item	Settings
public	When [Use of Storage] is set to [Allow], the PDF files for PC viewing in the "public" folder can be accessed.
shared	If the [Use of Storage] is set to [Allow], you can use the "shared" folder as a network folder.
faxreceive	If the [Use of Storage] is set to [Allow], you can use the "faxreceive" folder as a fax/Internet fax received data. The "faxreceive" folder contains files of "Settings for HDD Storing of Received Data".



Proxy Setting

Access the network through a proxy server.

Settings

Item	Description
Proxy Setting	Set whether proxy settings are used.
Proxy Server Address	Enter the proxy server address.
User Name	Enter a user name to access the proxy server.
Password	Enter a password to allow access to the proxy server.
Port Number	Enter the proxy server port number.
Address without Using Proxy	Specify exception addresses for a proxy that is used in the external service connect function, Google Cloud Print and Sharp OSA. [Entry method] 1) Can be set using a host name or an IP address. 2) When using a host name, you can use a wildcard (*) at the beginning of the domain name. (Example: "*example.□□□" (equivalent to "example.□□□", "sub.example.□□□", "subexample.□□□", etc.) 3) When using an IP address, you can use a wildcard (*) at the end of the address. (Example: "10*" (equivalent to 100.nnn.nnn.nnn to 109.nnn.nnn.nnn) If the Sharp OSA application using "HTML Browser 3.5" is set to an exception address, rule (3) cannot be used. 4) You can use a separator (semicolon (;)) to enter multiple addresses. (Example: "99.99.99.99;example.□□□")

Wireless Settings

It provides access to a network via a wireless LAN.

Clicking the [Submit] button stores the settings.

Connection Type

Use this setting to switch between [Wired Only], [Wired+Wireless (Access Point Mode)] or [Wireless (Infrastructure Mode)].

Keep Wireless Access Point activated

This can only be enabled when "Connection Type" is "Wired+Wireless (Access Point Mode)".

If disabled, the NFC card reader must be touched to the mobile device or the [Easy Connect (QR code)] key must be tapped in the home screen to enable wireless LAN.

When one of the conditions below occurs, the wireless LAN connection is automatically canceled.

- When auto clear or auto power shutoff is performed on the machine.
- When there is no connection to the access point for a certain period of time.

Current Setting

Shows settings, such as the SSID of a wireless LAN and security type. If the wireless LAN is disabled, "--" appears.

Current Wireless Status

This shows reception levels (Max. 100) of the wireless LAN and IP addresses.

Show Wireless Setting Screen

Click the [Setup] button.

In the Wireless Setting screen, you can configure the SSID of a wireless LAN, Security Type, Encry., and Security Key.



Initialize Wireless Settings

Click the [Initialize] button.

The settings for SSID, Security Type, Encry., and Security Key are initialized.

Wireless Setting screen (Access Point Mode)

If the [Setup] button is clicked while [Connection Type] is set to [Wired+Wireless (Access Point Mode)] or [Wired Only], the Wireless Settings (Access Point Mode) screen is displayed.

Configure the SSID of a wireless LAN, Security Type, Encry., and Security Key.

Clicking the [Submit] button stores the settings.

SSID

Enter an SSID using up to 32 characters.

Security Type

Select a security type.

Encry.

Select an encryption type.

Security Key

Enter a security key.

Security Type	Security Key
<ul style="list-style-type: none"> • WEP • WPA/WPA2-mixed Personal • WPA2 Personal 	<p>WEP64bit: 5 characters or 10-digit hexadecimal number</p> <p>WEP128bit: 13 characters or 26-digit hexadecimal number</p> <p>WPA/WPA2: 8 to 63 characters or 64-digit hexadecimal number</p>

Show Security Key

If it is set to ON, the security key appears.

Device IP Address (Access Point Mode)

Enter the IP address.

Channel

Select the channel to be used in wireless LAN.

Sending Output

Configure the sending output.

Bandwidth

Use this setting when the communication mode is "11n". Select the bandwidth to be used.

IP Address Distribution Range Setting

Configure the range to be used the IP address.

Wireless Setting screen (Infrastructure Mode)

If [Connection Type] is set to [Wireless (Infrastructure Mode)] and the [Setup] button is clicked, the infrastructure mode wireless setting screen is displayed.

Configure the SSID of a wireless LAN, Security Type, Encry., and Security Key. Clicking the [Submit] button stores the settings.

Access Point Search

Click this to search access points. When the search results are displayed, select the access point to use and click [OK]. [SSID], [Security Type], and [Encry.] are automatically applied.



SSID

Enter an SSID using up to 32 characters.

Security Type

Select a security type.

Encry.

Select an encryption type.

Security Key

Enter a security key.

Security Type	Security Key
<ul style="list-style-type: none"> • WEP • WPA/WPA2-mixed Personal • WPA/WPA2-mixed Enterprise • WPA2 Personal • WPA2 Enterprise 	<p>WEP64bit: 5 characters or 10-digit hexadecimal number</p> <p>WEP128bit: 13 characters or 26-digit hexadecimal number</p> <p>WPA/WPA2: 8 to 63 characters or 64-digit hexadecimal number</p>

Show Security Key

If it is set to ON, the security key appears.

Easy Connection Setting

NFC

This appears when an NFC card reader is connected. Enable this setting to connect to mobile devices using an NFC card reader.

QR code

You can install the dedicated application in a mobile device in advance, and scan the displayed QR code to send and save the connection settings to the mobile device.

Destination

Set the connection destination for connection by NFC card reader, or the connection destination associated with the QR code.

To connect to the machine, select [Connect with the machine]. The information required to connect to the machine is saved in the application.

To connect to a destination other than the machine, select [Connect with the following access point].

To set manually, obtain the network information of the connection destination in advance.

When [Connect with the following access point] is selected, configure the following settings.

Access Point Search

Click this to search access points. When the search results appear, select the access point to be used and click [OK]. [SSID] of the selected access point, [Security Type], and [Encry.] are automatically applied.

Name

Enter the access point name.

SSID

Enter an SSID using up to 32 characters.

Security Type

Select a security type.



Encry.

Select an encryption type.

Security Key

Enter a security key.

Security Type	Security Key
<ul style="list-style-type: none"> • WEP • WPA/WPA2-mixed Personal • WPA2 Personal 	WEP64bit: 5 characters or 10-digit hexadecimal number WEP128bit: 13 characters or 26-digit hexadecimal number WPA/WPA2: 8 to 63 characters or 64-digit hexadecimal number

Show Security Key

If it is set to ON, the security key appears.

Device Web Page Setting

The following explains the access settings to Setting mode (Web version).

Number of Users who can Log-in at the Same Time

Enter a number of users who can access Setting mode (Web version) simultaneously.

Auto Logout Time

Enter a time to automatically log out when no communication continues with the machine.



When settings are changed, the changes will take effect after the machine is restarted. To restart the machine, see "[TURNING ON THE POWER \(page 1-10\)](#)".

View Login User

The user or users who have logged in this machine are displayed.

Current Login User

The currently logged in users are displayed.

Logout All Users

The current login users are logged out.



When settings are changed, the changes will take effect after the machine is restarted. To restart the machine, see "[TURNING ON THE POWER \(page 1-10\)](#)".



Security Settings



When settings are changed, the changes will take effect after the machine is restarted. To restart the machine, see "[TURNING ON THE POWER \(page 1-10\)](#)".

Password Change

Restrict Device Web Page Access Via Password

Use this setting to display the login screen and require login in order to access the Web server.

Change Password

The administrator password can be changed.

When changing the password, be sure to remember the new password.

(It is recommended that you periodically change the administrator password.)

Enter a password consisting of 5 to 32 characters, and tap the [Store] key.

Your setting is made valid only when the machine is turned On again.

- The user-level authentication password is required to add, edit or delete the destination. When you log on, enter "users" as the user name. Then, enter the user password that you have registered with this option. The administrator-level authentication password is required to select all settings and the same functions as those available with the user-level password. When you log on, enter "admin" as the user name. Then, enter the administrator password that you have registered with this option.
 - If you tap the [Store] key without entering a password, the previously set value is assumed. Password protection is enabled by default.
-



In the factory default state, the user password must be entered.
(For the default password, see "Start Guide".)



Port Control

Enable or disable main system ports, set the port numbers, and tap the [Store] key. The following ports can be configured.

Server Port	Client Port
<ul style="list-style-type: none"> • HTTP • HTTPS • FTP Print • Raw Print • LPD • IPP • IPP-SSL • Tandem Output Receive • PC Scan • Remote Operation Panel • SNMPD • NBT/WINS • SMTP • BMLinkS • WSD • Print Release • Sharp OSA (Expansion Platform) <ul style="list-style-type: none"> • HTTP • HTTPS 	<ul style="list-style-type: none"> • HTTP • HTTPS • FTP • FTPS • SMTP • SMTP-SSL • POP3 • POP3-SSL • SNMP-TRAP • Notify Job End • LDAP • LDAP-SSL • SMB/WINS • SNTTP • mDNS • Tandem Output Send • Data Backup (Send) • Print Release • XMPP

Filter Setting

You can set the filter by an IP or MAC address to prevent an unauthorised access to the machine via a network. Set the IP or MAC address filter and tap the [Store] key.

IP Address Filter Settings

This option sets an IP address.

You can specify whether to allow or prohibit access to the machine from the IP address you set.

MAC Address Filter Settings

This option sets a MAC address.

It allows access to the machine from the MAC address you set.

SSL Settings

SSL can be used for data transmission over a network.

SSL is a protocol that enables the encryption of information communicated over a network. Encrypting data makes it possible to transmit and receive sensitive information safely.

Data encryption can be set by the following protocols.

Server Port

- **HTTPS:** Apply SSL encryption to HTTP communication.
- **IPP-SSL:** Apply SSL encryption to IPP communication.
- **Redirect HTTP to HTTPS in Setting mode (Web version) Access:**
When this setting is enabled, all communication that attempts to access the machine by HTTP is redirected to HTTPS.



Client Port

- **HTTPS:** Apply SSL encryption to HTTP communication.
- **FTPS:** Apply SSL encryption to FTP communication.
- **SMTP-SSL:** Apply SSL encryption to SMTP communication.
- **POP3-SSL:** Apply SSL encryption to POP3 communication.
- **LDAP-SSL:** Apply SSL encryption to LDAP communication.

Level of Encryption

The encryption strength can be set to one of three levels.

Device Certificate

Certificate Status

Shows the status of the certificate required for transmission using SSL. To install a certificate, click [Install].

Export Certificate and Private Key

When a certificate is installed, you can export the certificate.

Make of Certificate Signing Request(CSR)

Enter the information below and click the [Execute] key to create a Certificate Signing Request (CSR).

Common Name (Required)

Enter the name to be used.

Organization

Enter the name of the organization.

Organizational Unit

Enter the name of the unit within the organization.

City/Locality

Enter the city or locality.

State/Province

Enter the state or province.

Country/Region (Required)

Enter the country code.

Key Length of Certificate

Enter the key length of the certificate.

Certificate Signing Request (CSR)

When you create a certificate signing request (CSR) with [Make of Certificate Signing Request(CSR)], the content of the certificate signing request (CSR) appears.

S/MIME Settings

Condition Settings

Set whether S/MIME is used for transmission.

Device Certificate

Certificate Status

Shows the status of the certificate required for transmission using S/MIME. To install a certificate, click [Install].

Sign Settings

Sign E-mail

Enable "Sign E-mail" to use a signature.

Signature Algorithm

Set the algorithm for the signature.



Encryption Settings

Sign E-mail

Enable "Sign E-mail" to use a signature.

Encrypt

Enable encryption.

Disable sending to the addresses which cannot be encrypted.

Prohibit transmission to addresses that cannot be encrypted.

Make of Certificate Signing Request(CSR)

Enter the information below and click the [Execute] key to create a Certificate Signing Request (CSR).

Common Name (Required)

Enter the name to be used.

Organization

Enter the name of the organization.

Organizational Unit

Enter the name of the unit within the organization.

City/Locality

Enter the city or locality.

State/Province

Enter the state or province.

Country/Region (Required)

Enter the country code.

Sender Address (Required)

Enter the address of the sender.

Key Length of Certificate

Enter the key length of the certificate.

Certificate Signing Request (CSR)

When you create a certificate signing request (CSR) with [Make of Certificate Signing Request(CSR)], the content of the certificate signing request (CSR) appears.

IPsec Settings

IPsec can be used for data transmission/reception on a network.

When IPsec is used, data can be sent and received safely without the need to configure settings for IP packet encryption in a Web browser or other higher-level application.

When enabling this settings, take the following notes.

- It may take some time to reflect on the machine settings, and you cannot connect to the machine during this time.
- If the Setting mode (Web version) settings are not correctly selected, connection to the machine may not be allowed, or the settings may not allow printing, scanning, or Setting mode (Web version) display. In this case, deselect this setting and change the System Settings (on Web pages).

Condition Settings

IPsec Settings

Specify whether or not IPsec is used for transmission.

IKEv1 Settings

Pre-Shared Key

Enter the Pre-Shared Key to be used for IKEv1.

SA Lifetime (time)

Set the SA lifetime.

SA Lifetime (size)

Set the SA lifetime size.

IKE Lifetime

Set the IKE lifetime.



IPsec Rules

The registered IPsec rules are displayed.

To add a new rule, click the [Add] key.

To delete a rule, select the rule you want to delete and click the [Delete] key.

IPsec Rule Registration

Rule Name

Enter a name for the IPsec rule.

Priority

Set the priority level.

Select the Rule Name to be the Registration Model

If there is a previously registered rule that is similar to the rule you want to create, you can create the new rule based on the registered rule.

Device Address

Set the type of IP address to be used on the machine and the port number (for IPv6, set the port number / prefix length).

Client Address

Set the destination IP address type and port number (for IPv6, set the port number / prefix length).

Communication Type

Set the communication type used for IPsec.

Protocol

Set the protocol to be used.

Filter Mode

Set the filter to be used for IPsec.

IPsec Encryption

Configure settings for the authentication method used for IPsec.

ESP

Select to use ESP authentication.

Allow Communication not using ESP

Specify whether or not communication that does not use ESP is allowed.

AH

Select to use AH authentication.

Allow Communication not using AH

Specify whether or not communication that does not use AH is allowed.

IEEE802.1X Setting

IEEE802.1X can be used to authenticate a user to allow use of the machine.

IEEE802.1X protocol defines port-based authentication for both wired and wireless networks.

Use IEEE802.1X authentication to allow only authenticated devices to use network, and protect against network abuse by third parties.

You can enable or disable IEEE802.1X authentication with this setting. The IEEE802.1X details can be set with Setting mode (Web version). Depending on the Web page settings, connection to the machine may not be allowed, or the settings may not allow printing, scanning, or Setting mode (Web version) display. In this case, deselect this setting and change the Setting mode (Web version) settings.

Condition Settings

IEEE802.1X Authentication

Set whether IEEE802.1X authentication is used.



EAP Authentication Method

Set the EAP authentication method in IEEE802.1X.

EAP User Name

Enter a maximum of 64 full-width/half-width characters for the EAP user name used for authentication.

Password

Enter a maximum of 64 half-width characters for the EAP password used for authentication.

Server Authentication

Set whether server authentication is used.

EAP Timeout

Set the EAP Timeout.

Number of EAP Retries

Set the number of EPS re-access times when transmission fails.

Device Certificate

Certificate Status

Shows the status of the certificate required for transmission using IEEE802.1X. To install a certificate, click [Install].

CA Certificate Status

Shows the status of the CA certificate required for transmission using IEEE802.1X. To install a certificate, click [Install].

Make of Certificate Signing Request(CSR)

Enter the information below and click the [Execute] key to create a Certificate Signing Request (CSR).

Common Name (Required)

Enter the name to be used.

Organization

Enter the name of the organization.

Organizational Unit

Enter the name of the unit within the organization.

City/Locality

Enter the city or locality.

State/Province

Enter the state or province.

Country/Region (Required)

Enter the country code.

Key Length of Certificate

Enter the key length of the certificate.

Certificate Signing Request (CSR)

When you create a certificate signing request (CSR) with [Make of Certificate Signing Request(CSR)], the content of the certificate signing request (CSR) appears.



Security Control

Restrict Print Jobs other than the current Print Hold Job

You can select settings to cancel print jobs that are not print hold jobs, or force all print jobs to be held. When [Restrict Print Jobs other than the current Print Hold Job] is turned ON, the settings below can be selected.

Item	Settings
Force Retention	This setting forcibly sets all print jobs as print hold jobs, even jobs for which print hold is not selected.
Disable Job	Prohibit all print jobs other than print hold jobs.

Reject Requests from External Sites

You can reject the request from external sites.

Document Administration Function

All of the transmitted image data (sent or received by facsimile or e-mail transfer) can be forwarded to any destination.

List name	Settings
Forwarding Destination Settings (Send Data)	
Forward Send Data	Set a destination to forward the send data.
E-mail/Network Folder/FTP/Desktop	Select a forwarding type of the send or received image data. When determined, select the destination from the address book. You can enter an e-mail directly. • Format: Select a format for data forwarding.
Clear Setting	Releases the destination settings.
File Format	Select the file format for inbound routing.
Forwarding Destination Settings (Received Data)	
Forward Received Data	Set a destination to forward the received data.
E-mail/Network Folder/FTP/Desktop	Select a forwarding type of the send or received image data. When determined, select the destination from the address book. You can enter an e-mail directly. • Format: Select a format for data forwarding.
Clear Setting	Releases the destination settings.
File Format	Select the file format for inbound routing.



Hidden Pattern Print Setting

Select Hidden Pattern Print Setting.

The hidden pattern print function is effective at preventing unauthorised copying as the specified text emerges in the background on output sheets.

Initial Status Settings

Default Settings

Item	Settings
Hidden Pattern Print Setting	A pattern print can be printed with this settings.
Print Colour	Select a print colour.
Exposure	Select an exposure.
Font Size	Select a font size.
Angle	Select a character angle.
Font Style	Select the standard or italic character settings.
Camouflage Pattern	Set a camouflage pattern.
Print Method	Select a character display pattern. <ul style="list-style-type: none"> • Positive • Negative

Print Contents Setting

Item	Settings
Pre-Set Word	Allows you to select a preset character string. The following character strings can be selected. <ul style="list-style-type: none"> • DO NOT COPY, Copy Ban, Internal Use Only, Handle with Care, CONFIDENTIAL, Copy Invalid, IMPORTANT, COPY
Fixed Phrase	Select a stored preset character string. This setting is ignored if [Direct Entry] is enabled. <ul style="list-style-type: none"> • DO NOT COPY, Copy Ban, Internal Use Only, Handle with Care, CONFIDENTIAL, Copy Invalid, IMPORTANT, COPY
Information Printing	Enables simultaneous printing of the following information sets. <ul style="list-style-type: none"> • Serial number, account job ID, login name/user number, number of copy control, date and time
Disable Direct Entry	Directly enters the user name. This setting is ignored if [Pre-set Text] is enabled.

Contrast

Set a character contrast.

The black, magenta, and cyan can be set in any of 9 levels.

Custom Text Registration

Stores the user-created print characters. Up to 30 characters can be stored.



Tracking Information Print

Prints the tracking information at the top or bottom of output pages when copy or print job is executed.

Item	Settings
Tracking Information Print Setting	Set this option to print the tracking information.
Print Information	The following information can be printed. <ul style="list-style-type: none"> Serial number, characters, account job ID, login name/user number, date and time
Select the Print Colour	Select a print colour.
Position	Set a print position on each page.
Select the Job to Print	Set a job to print the tracking information.

Audit Log

Logs are created and saved for various events relating to security functions and settings.

Audit logs are created and saved in English. However, setting values such as filenames which are input from external sources are saved as-is.

Audit logs which have been saved in the internal storage can be exported by an administrator to a PC as TSV files.

You can select either the internal storage or an external server as the destination for saving audit logs.



When the space for saving audit logs internally becomes full, the logs are overwritten starting from the oldest ones.

Audit Log

"Audit Log" can be carried out as follows.

In "Settings (administrator)", select [System Settings] → [Security Settings] → [Audit Log]

Select "Security Control", "Storage/Send Settings" or "Save/Delete Audit Log".

Storage/Send Settings

"Storage/Send Settings" can be carried as follows.

In "Settings (administrator)", select [System Settings] → [Security Settings] → [Audit Log] → [Storage/Send Settings]

Then make the storage and transmission settings.

Save/Delete Audit Log

"Save/Delete Audit Log" can be carried out as follows.

In "Settings (administrator)", select [System Settings] → [Security Settings] → [Audit Log] → [Save/Delete Audit Log]

Select "Save Audit Log" or "Delete Audit Log".



"Save Audit Log" can only be carried out from the web page.



Energy Save

Eco Setting

The machine's power consumption can be reduced by Eco Mode setting. Although each function setting can be changed separately, the machine has the "Custom" and "Eco Mode" to allow simultaneous changing of settings.

Eco Recommendation Function Display

You can display eco-recommended functions such as two-sided printing and N-Up during copying, document filing print, and direct print.

Setting values applied by each mode is as follows.

Energy Save	Custom Mode	Eco Mode
Eco Scan	On	On (All Modes Except Copy)
Auto Power Shut-Off Timer	Fix transition time.: 11min. (for Europe) 1min. (Except for Europe)	Fix transition time.: 1min.
As soon as the remote job is finished, enter Auto power shut off mode.	Off	On
Preheat Mode Setting	1min.	1min.
Turn off Panel Display during pre-heat mode	On	On



Each Energy Save settings in System Settings is not applied when Custom/Eco mode is used.

Display Message When Extending Transition Time to Preheat/Auto Power Shut-Off Mode

Set whether a message is displayed 15 seconds before Preheat Mode or Auto Power Shutoff Mode is entered.

Mode Setting

Item	Settings
Custom Mode	Allows easy machine operation with reduced power consumption.
Eco Mode	Minimizes the machine's power consumption.



Preheat Mode Setting

Set the number of minutes until preheat mode activates. Set a number from 1 to 60 (MX-2630N/MX-3050V/MX-3060V/MX-3070V/MX-3550V/MX-3560V/MX-3570V/MX-4050V/MX-4060V/MX-4070V) or 1 to 120 (MX-5050V/MX-5070V/MX-6050V/MX-6070V) in increments of 1 minute.

Preheat Mode will activate when the set duration of time elapses after printing ends and no further operations are performed. This function reduces your power costs, and at the same time helps conserve natural resources and reduce pollution.

Select the time that best suits the needs of your workplace.

The panel display can be turned Off in the Preheat mode.



Preheat mode cannot be disabled.

Turn off Panel Display during pre-heat mode

Set whether the lights on the operation panel turn off in preheat mode.

Auto Power Shut-Off

When the machine is idle for the set time after printing, it enters auto power shutoff mode. In this mode, the machine waits on standby using a minimum amount of power.

Use this setting to specify whether auto power shutoff is used.



In Europe, this setting is not available and auto power shut-off is always enabled.

As soon as the remote job is finished, enter Auto power shut off mode.

This function works in Auto Power Shut-Off mode. When the machine completes a print job received from the PC or outputs received fax data, the machine immediately returns to the Auto Power Shut-Off mode.

Fix transition time.

The Auto Power-Off transition time is fixed.

When this setting is enabled, the [Change transition time by time of day.] option is disabled.



If the Auto Power-Off is disabled, the time you have set here is disabled.



Change transition time by time of day.

This function controls the transition to Auto Power Shut-Off mode optimally for each time period by analyzing the use of the machine based on job logs obtained during a 4-week period.

When this setting is enabled, the [Fix transition time.] option is disabled.



- The image transfer control settings are not changed.
- This does not link to the Power On/Off Scheduling. If both of them are enabled, the Power On/Off Scheduling settings precede.
- Pages are counted for each paper size separately.
- When the power supply of the machine was off, there was no job during this time.

Transition to Energy Saving and Auto Power Shut-Off modes

Pattern	Transition time	Average outputs per hour*
Mode1 (Job Start Priority1)	After 1 hour	700 or more
Mode2 (Job Start Priority2)	After 30 minutes	150 to 699
Mode3 (Energy Saving Priority1)	After 5 minutes	40 to 149
Mode4 (Energy Saving Priority2)	After the minimum time period	Up to 39
Sleep Mode Power Level	<p>Low Power : The machine switches to the power saving mode, but it takes some time to recover.</p> <p>Fast Wake Up : Compared with Low Power, the power value rises by a certain degree, but it results in faster recovery.</p> <p>Motion Sensor Mode (MX-3060V/MX-3070V/MX-3560V/MX-3570V/MX-4060V/MX-4070V/MX-5070V/MX-6070V): This enables switching of power saving modes by the motion sensor.</p>	–

* Factory default setting

Automatic

This function controls the power optimally for each time period by analyzing the use of machine based on job logs obtained during a certain time period.



If the machine does not have the 4-week job log information, the machine enters the template2 (Mode3 (Energy Saving Priority1) between 8:00 and 18:00 hours). Then after that, it enters Mode4 (Energy Saving Priority2).



Manual

You can set a pattern for each time band.

The machine already has the 3-pattern template. The Energy Save pattern can be added to the "Original Eco Patterns 1 to 4".

Three-pattern template

Template	Pattern	Description of mode
Template 1	All Day "Energy Save Priority2"	The machine runs in the "Mode4 (Energy Saving Priority2)" all the time.
Template 2	8:00-18:00 "Energy Save Priority1"	The machine runs in "Mode3 (Energy Saving Priority1)" between 8:00 and 18:00, and in "Mode4 (Energy Saving Priority2)" at other times.
Template 3	8:00-18:00 "Job Start Priority1"	The machine runs in "Mode1 (Job Start Priority1)" between 8:00 and 18:00, and in "Mode4 (Energy Saving Priority2)" at other times.

Sleep Mode Power Level

Low Power:

The machine switches to the power saving mode, but it takes some time to recover.

Fast Wake Up:

Compared with Low Power, the power value rises by a certain degree, but it results in faster recovery.

Motion Sensor Mode

(MX-3060V/MX-3070V/MX-3560V/MX-3570V/MX-4060V/MX-4070V/MX-5070V/MX-6070V only):

The motion sensor enables the machine to automatically wake from sleep mode.



Eco Scan Setting

Eco Scan Setting is used to execute a non-print operation such as image sending and scan to HDD while the fusing unit is turned Off.

Set "Eco Scan Setting" to , and select a mode or screen in which to enable Eco Scan Setting.

The following modes and screens can be set.

- Home Screen
- Copy
- Image Send
- Document Filing
- System Settings
- Sharp OSA
- Manual Finishing

Energy Saving Pattern List

This function analyzes machine usage and controls entry into auto power shutoff mode based on frequency of use.

If you want to manage machine power by using an energy saving pattern list, select [Manual] in [System Settings] - [Eco Setting] - [Change transition time by time of day.], and select an Automatic Update Pattern from the pull-down list or one of Original Eco Patterns 1 to 4.

To automatically analyze machine usage and update the pattern as needed, set Automatic Update Pattern.

Edit Pattern

Set the Original Eco Pattern.

Item	Description
Change Pattern Name	To change the pattern name, enter the desired name.
Pattern to Be Modeled	Select the stored pattern that you want to base the new pattern on. To copy the settings of a selected pattern, select [Copy the selected pattern.].
Energy Save Setting	Set time periods for machine modes. Select a mode from 1 to 4, and select a day of the week, start time, and end time.
Day of the Week	Set the day of week on which you want to enable the mode selected in the Energy Save Setting.
Start Time/Completing Time	Set the period of time during which you want to enable the mode selected in the Energy Save Setting.



Specific Date Operation Settings

You can configure a day on which you have high-output printing or want to perform a special operation as the "specific date" and set a specific energy saving pattern only for that specific date.



The specific date operation is performed on the day configured as the specific date regardless of the setting on Auto Power-Off transition time (enabled or disabled).

"Specific Date" tab

A period of up to 7 days can be set for Specific Date. Set the specific date, energy saving pattern to be applied, and the operation that takes place if the specific date falls on a non-work day.

Item	Description
Date Setting	Configure the date on which you want to operate the machine with a specific pattern. Select a day between 1 and 31 in Every Month or from End of Every Month.
Applied Energy Saving Operation	Select an energy saving pattern you want to apply. Use the "Pattern" tab (page 7-167) to specify the details of the energy saving pattern.
Operation for Holiday	Configure how the machine operates if the preset specific date falls on a holiday. Use the "Holiday" tab (page 7-167) to specify the day as the holiday.



- If a specific date that is initially specified coincides with the one that is moved because it falls on a holiday, the setting for the former takes precedence.
- If specific dates of the same dates are configured, they are used in ascending order between 1 and 7 (specific date numbers).

"Pattern" tab

This tab is used to configure the details of an energy saving pattern.

Item	Description
Energy Save Operation	Select a specific date pattern you want to specify.
Change Pattern Name	Enter a pattern name when you want to change the name of a specific date pattern.
Pattern to Be Modeled	Select a source pattern when you create a pattern using a stored or preset pattern.
Add new schedule.	Add a schedule.

"Holiday" tab

Specify a holiday. The day you specified as the holiday will not be a specific date.

Item	Description
Holiday List	When you tap this option, the dates and days of the week for the holidays you have set for two years.
Day of Week	Use this option to specify a holiday using a day of the week.
Set Period	Use this to specify a holiday using a date. "Final Registered Time" shows when the holiday that is stored with Set Period was stored.



Power ON/OFF Schedule Setting

The machine operator panel can be turned On or Off at a preset time. Up to three (3) patterns can be set. The "Setting 1", "Setting 2" and "Setting 3" are executed in this sequence if set at the same day of week or at the same clock time.



- The scheduling function does not support the power management settings in the Preheat Mode and Auto Power Shut-Off Mode.
- The preset power-off time is subject to the following restrictions:
 - If the machine is running due to the current job execution or other reasons, the machine is turned off only after the job has finished.
 - The machine cannot receive printer jobs.
 - The machine can receive output jobs, such as received fax data outputs.
 - If the Time Specified Output of Received Data setting is enabled, they are output next time the machine is turned on.
 - If the power management setting is also enabled, the Power On/Off Scheduling settings precede.
 - If the same time is specified, settings are applied in the order of "Setting 1", "Setting 2", and "Setting 3".
- The power is not turned off in the following cases:
 - "Power Up Auto Clear" is in progress.
 - While the optimization of the hard disk is in progress or while a restart is in progress after the setting mode has been changed.
- The preset power on/off time is within one minute from when the setting is accepted.

Toner Save Mode

This mode is used to reduce toner consumption.

Toner consumption can be set for each print job of "Copy", "Printer", and "Prints (Document Filing)".

Toner consumption can be selected from three levels.

- **Toner Save1** (Toner Consumption: Much)
- **Toner Save2** (Toner Consumption: Middle)
- **Toner Save3** (Toner Consumption: Little)



Items may not be displayed depending on country and region.



System Control

Job Log

Job Log Operation

Deletes or stores log of a job executed on the machine.

Set the number of jobs for [The Number of Job Log to Notify by E-mail] and click [Store].

Tap the [Delete] key to delete the job log.



You can save the job log by selecting the [Job Log] in Setting mode (Web version).

View Job Log

Views log of a job executed on the machine.

Select a view item and period, and tap the [Show] key.

Data Import/Export (CSV Format)

You can import or export data.

Export Settings

Export Settings Type

Select the data to be exported from the address book or registered user information. Once you have selected the data, click the [Execute] key. The data will be exported in CSV format.

Import Settings

Import settings from file

You can import data that was exported in CSV format into the machine.

Storage Backup

Address book information and user information stored in the machine can be saved to and retrieved from a USB memory device. To use the machine to manipulate a file, first insert the USB memory device in the machine. If you need to select settings on the Web page, use your computer to manipulate the file.

Export

Exports data.

Import

Imports data into the machine.



Device Cloning

Saves the machine setting information in XML format and copies the information to another machine. This function saves you the trouble of repeatedly configuring the same settings in multiple machines. To use the machine to manipulate a file, first insert the USB memory device in the machine. If you need to select settings on the Web page, use your computer to manipulate the file.

Export

Exports data.

Import

Imports data into the machine.



- You can import data only to MX-2630N/MX-3050V/MX-3060V/MX-3070V/MX-3550V/MX-3560V/MX-3570V/MX-4050V/MX-4060V/MX-4070V/MX-5050V/MX-5070V/MX-6050V/MX-6070V.
- The following data is not copied when device cloning is performed:
 - List print and fax forwarding items.
 - Count and device status display items.
 - IP address of the machine, device name, administrator password, sender names for image send, and other information that is specific to the machine.
 - The settings specific to each hardware such as screen contrast, colour adjustment, and saddle stitch position adjustment

Address Book Forward

Forward the data stored in the address book of the machine to another machine.

To forward the address book contents, enter the IP address of the destination machine and the password of the administrator of that machine, and tap the [Execute] key.

Filing Data Backup

You can back up a file saved with Document Filing, and restore a backed up file to the machine.



Use setting mode (Web) to create backups of filed data.

Export Settings

Select the folder you want to back up and click [Execute]. The files are saved to your computer.

Item	Description
Index	The displayed Folder names can be filtered by index.
Display Items	Set the number of files that are displayed.

Import Settings

You can restore a file to the machine that was saved with “Export Settings”. Enter a maximum of 200 characters for the path of the saved file in “Import settings from file”, and click [Execute].



Storing/Calling of System Settings

You can reset the current Setting mode settings to the previously stored settings or to the factory default settings.

Store Current Configuration

Stores the currently configured Setting mode in the machine memory.

The stored settings will be retained even if the [Power] button is turned off. To retrieve the stored settings, use "Restore Configuration" below.

Items not stored

- Network Settings: These are not stored as unexpected settings may cause damage to the network.
- Product Keys: Product Keys are not stored as reissue of keys may be necessary.

Restore Configuration

Restores the settings stored with "Store Current Configuration".

The current settings are replaced by the retrieved settings.

Reset Settings

Restore Factory Defaults

Restores the current settings (you have selected in Setting mode) to the factory default settings. If you wish to create a record of the current settings before restoring, print the current settings by selecting [Status] in "Settings (administrator)" → [Data List] → [List for Administrator].



When settings are changed, the changes will take effect after the machine is restarted. To restart the machine, see "[TURNING ON THE POWER \(page 1-10\)](#)".

Reset the NIC

This returns all "Network Settings" to the factory default settings.

Optimization of Hard Disk

Various devices mounted on the machine can be set.

This function optimizes the hard drive of the machine by defragmenting data. If a job is in progress, a message will appear and optimization will not begin until the job is finished. During optimization, the following operations are not possible:

- Access to Setting mode (Web version), and reception of print data
- Use of keys on the operation panel
- Turning off the power with the main power switch of the machine.
- Auto Power Shut-Off

When optimization is completed, the machine will automatically restart.



When the document filing function is frequently used and output of files seems somewhat slow, optimizing the hard drive may improve performance.



E-mail Alert and Status

Status Message

Selects the Standard E-mail Status function or Advanced E-mail Status function settings.

The E-mail Status function can periodically transmit the machine status information to the stored address.

Standard

Sets the E-mail status address list 1, E-mail status address list 2, and E-mail status dealer address list separately.

Item	Description
E-mail Address	Enter the destination e-mail address for transmission of machine status information. When you enter multiple addresses, separate them by a semicolon (;) or a comma (,).
Send Now	When tapped, the status message is sent to the destination of the e-mail address list.
Send on Schedule 1	If checked as <input checked="" type="checkbox"/> , an E-mail is sent periodically according to the preset schedule.
Send on Schedule 2	If checked as <input checked="" type="checkbox"/> , an E-mail is sent periodically according to the preset schedule.
Time Schedule	Select a schedule to send E-mails.

Advanced

Bi-directional status message

Select whether or not bi-directional messages are enabled.

Item	Description
POP3 Server	Enter the IP address or host name of the POP3 server.
Port Number	Enter the port number of the POP3 server. The default setting is port 110.
POP Authentication	The authentication protocol (including APOP) is used for authentication to the POP3 server.
User Name	Enter the user name. The special user account is required for bi-directional e-mail status transmission.
Password	Enter the password. To change the password, set [Change Password] to <input checked="" type="checkbox"/> .
Check Interval	Enter the polling interval for the POP3 server. The default setting is five minutes.
Enable SSL	<input checked="" type="checkbox"/> Allows the POP over SSL communication or the POP over TLS communication by STLS command. This requires the server to support the POP over SSL communication or the STLS command. To allow SSL communication, set the "Port Number" to the POP over SSL communication port number. To allow POP over TLS communication, set the "Port Number" to the same port number as for the normal POP3 communication.
Connection Test	Tap the [Execute] button to test the connection to the POP3 server.

Alerts Message

Selects the E-mail Alert function settings.

The E-mail Alert function can report a trouble of the machine to the administrator or dealer using e-mail.

Sets the E-mail Alert Message List 1, E-mail Alert Message List 2, and Dealer E-mail Alert Message List separately.

E-mail Address

Enter the destination E-mail address for alert message transmission. You can enter multiple addresses by separating them by a semicolon or comma.

Example: aaa@xxxxx.□□□; bbb@xxxxx.□□□

A report will be sent by e-mail in the following situations.

Jam, Toner Low, Toner Empty, Paper Empty, Service Request, PM Request, Waste Toner Almost Full, Waste Toner Full, Job Log Full



Image Quality Adjustment



- Registration Adjustment and Fusing Cleaning Mode in [Collective Adjustment], all Common Functions, and removal of a toner cartridge can only be executed in setting mode on the machine.
- Colour Profile Settings can only be configured on the Web page.

Collective Adjustment

Various devices mounted on the machine can be set.

Registration Adjustment

If colour shift occurs on the printed side when colour printing is performed, the print positions of the colours can be adjusted to reduce colour shift.

Tap the [Execute] key.

Fusing Cleaning Mode

Use this function to clean the machine's fusing unit when dots or other dirt appear on the printed side of the paper. When this function is executed, "V" printed paper is output and the fusing unit is cleaned.



If improvement is not noticed after the first time you use the function, try executing the function again.

MC Cleaning Mode

(MX-5050V/MX-5070V/MX-6050V/MX-6070V only)

This machine periodically executes automatic cleaning and normally it is not necessary to execute this mode. Only in case, however, that black or coloured lines (linear colour unevenness) appear on the printed paper, execute this mode.



Do not use this function when no black or coloured lines appear. Using this function under the normal condition may cause deterioration of the cleaner.

Black Letter/Black Line Width Adjustment

Adjust black text and the width of black lines. After using this function to perform adjustment, perform [System Settings] - [Common Functions] - [Auto Colour Calibration (for Copy)], [Auto Colour Calibration (for Print)].

Black Streak Reduction

Specify to use the black streak reduction or not.

The black streak reduction can be used for Scan Original, Copy, Image Send, and Scan to HDD functions.

If the black streak reduction is enabled, select any of the following options.

- **Treat Thin Black Streaks:** Use this setting to make thin black streaks less apparent. (Low level)
- **Normal:** Use this setting to make black streaks less apparent. (Medium level)
- **Treat Up to Thick Black Streaks:** Use this setting to make thick black streaks less apparent. (High level)



Increasing the level of black streak treatment may result in faint text and poor reproduction of lines.

Display warning message for black streaks detection.

Set this option to display a warning message when black streaks are detected by the document feeder.



Copy Image Quality

Quick Image Quality Adjustment

You can easily perform copy quality adjustment in the default state.
You can change the default setting ([2]) to [1 (Smooth)] or [3 (Sharp)].

Colour Balance (Colour / B/W)

You can adjust the default colour, gradation, and density of colour copies and black & white copies.
The density of each colour is divided into 3 ranges, and you can adjust the level of each.

Color Copy Black Component Amount Adjustment

Adjust the proportion of the black component in copy quality settings.
Set this for auto, text / printed photo, text, printed photo, photo-paper photo, text / photo-paper photo, map, and faint original in the original type settings, and for text / printed photo, text, and printed photo when the original is a copy.

Density Adjustment when [Auto] is selected for Exposure

Configure settings for colour copying and black & white copying when [Auto] is selected for the copy exposure. The exposure can be adjusted separately for copying using the document glass and copying using the auto document feeder.

Sharpness

You can make copy images in the default state sharper or softer.

Image Quality Priority

Specify image quality priority. Set this for the auto copy exposure and text / printed photo settings.

Print Image Quality

Quick Image Quality Adjustment (Colour / B/W)

Perform quick adjustment of print quality.
You can change the default setting ([2]) to [1 (Smooth)] or [3 (Sharp)].

Colour Balance (Colour / B/W)

You can adjust the tone and density of colour in colour printing and black & white printing.
You can adjust the default colour, gradation, and density of colour copies and black & white copies.
The density of each colour is divided into 3 ranges, and you can adjust the level of each.

Exposure Adjustment

Set the density of colour printing and of black & white printing.

Colour Line Width Adjustment

When colour lines do not print correctly in special applications such as CAD, you can make lines thicker.



Scan Image Quality

RGB Adjust

Set the colour tone (RGB) for scanning.

Sharpness

Use this setting to obtain a sharp image when scanning an original.

Contrast

You can adjust the contrast of scanned images.

Colour Profile Settings

Set colour profiles used for printing.

Custom CMYK Simulation Profile

Current Profile Name

This shows the currently set profile name.

Profile Update

Select the updated colour profile and click the [Store] key.

Custom Input Profile

This shows the currently set profile name.

Profile Update

Select the colour profile you want to update and click [Store].



Common Functions

Auto Colour Calibration (for Copy)

Auto Colour Calibration (for Print)

Copy Calibration by Screen

Printer Calibration by Screen

Performs automatic colour correction when the colour is off.

For copying, adjust with [Auto Colour Calibration (for Copy)]. For printing, adjust with [Auto Colour Calibration (for Print)]. You can use [Copy Calibration by Screen] and [Printer Calibration by Screen] to perform even higher precision adjustment of each mode.

The machine prints a test patch, the test patch is scanned, and the colour is automatically corrected.

After the [Execute] key is tapped and a test patch is printed, a message appears prompting you to begin automatic calibration.

Follow the instructions in the message to perform colour adjustment.



- Before executing Auto Colour Calibration, check to see if the registration adjustment is correct. If the registration adjustment is not correct, perform "Registration Adjustment."
- If the colour is still off after performing Auto Colour Calibration, repeating Auto Colour Calibration once again may improve the colour.

Density Smoothing Adjustment

If uneven density occurs in a copy and others, use this function to smooth the density.

The uneven density is automatically corrected by scanning a test patch that you print.

After the [Execute] key is tapped and a test patch is printed, a message appears prompting you to begin automatic adjustment.

Follow the instructions in the message to perform density smoothing.

If there are no problems after adjustment, perform "Auto Colour Calibration (for Copy)" and "Auto Colour Calibration (for Print)".

To return the adjusted values to their factory default state, tap [Return Density Smoothing Adjustment Value to Defaults]. If you tapped [Return to the Defaults], perform adjustment of the density that you want to readjust (medium density in the default mode).



- If the intensity deviation correction does not resolve the intensity deviations, repeat the correction. This may suppress the deviations.
To repeat the correction, start over the procedure from the first step, or tap the [Back] key after going through the correction procedure.

Remove Toner Cartridge

Normally toner cartridges cannot be removed. However, when a cartridge runs out of toner, the cartridge is automatically ejected to allow removal. If you need to remove a cartridge that still has toner, you can manually eject and remove the cartridge.

Select the toner cartridge to be ejected and tap the [Execute] key. The selected cartridge is ejected to allow removal.



- To remove the toner cartridge, use the operation panel on the machine. You cannot perform the cartridge removal operation on the web screen.



Initial Installation Settings

This groups together the items that were set initially when the machine was installed. The initial installation setting items are the same as the regular setting items that have the same name. For information on a setting item, see the explanation of the regular item.

Item	Description
Condition Settings	
Name	
Machine Code	
Machine Location	System Settings - Common Settings - Machine Identification Settings (page 7-134)
Memo	
Clock Adjust	System Settings - Common Settings - Clock Adjust (page 7-135)
Daylight Saving Time Setting	System Settings - Common Settings - Clock Adjust (page 7-135)
Preheat Mode Setting	
Auto Power Shut-Off	
Display Message When Extending Transition Time to Preheat/Auto Power Shut-Off Mode	System Settings - Energy Save - Eco Setting (page 7-162)
Sleep Mode Power Level	
Network Quick Settings	System Settings - Network Settings - Quick Settings (page 7-137)
Tray Settings	System Settings - Common Settings - Paper Settings- Paper Tray Settings (page 7-119)
Product Key	System Settings - Common Settings - Product Key (page 7-136)



SETTING MODE FOR FAX

The following lists the Setting mode for fax and factory default settings.



Depending on the machine specifications and peripheral devices installed, it may not be possible to use some settings.

System Settings

U: General user; A: System administrator/Administrator

Setup Items	Factory default setting	U	A
■ System Settings			
● Image Send Settings (page 7-180)		No	Yes
▶ Fax Settings		No	Yes
◆ Default Settings		No	Yes
• Resolution Setting		No	Yes
- Apply the Resolution Set when Stored	Disabled	No	Yes
+ (No item)	Standard	No	Yes
• Dial Mode Setting*1	Tone	No	Yes
• Auto Wake Up Print	Enabled	No	Yes
• Pause Time Setting	2 seconds	No	Yes
• Fax Dest. Confirmation Mode	Disabled	No	Yes
• Speaker Settings		No	Yes
- Speaker	Volume: 5	No	Yes
- Ringer Volume	Volume: 2	No	Yes
- Line Monitor	Volume: No Sound	No	Yes
- Fax Receive Complete Signal	Volume: 2; Tone Pattern: 3 Transmission Complete Sound Time Setting: 3 sec.	No	Yes
- Fax Send Complete Signal	Volume: 2; Tone Pattern: 3 Transmission Complete Sound Time Setting: 3 sec.	No	Yes
- Fax Communication Error Signal	Volume: 2; Tone Pattern: 3 Transmission Complete Sound Time Setting: Every 0.3 seconds	No	Yes
• Remote Reception Number Setting	5	No	Yes
• Original Print on Transaction Report	Print Out Error Report Only	No	Yes
• Transaction Report Print Select Setting		No	Yes
- Single Sending	Print Out Error Report Only	No	Yes
- Broadcasting	Print Out All Report	No	Yes
- Receiving	No Printed Report	No	Yes



Setup Items	Factory default setting	U	A
- Confidential Reception	Print Out Notice Page	No	Yes
• Activity Report Print Select Setting		No	Yes
- Auto Print at Memory Full	Disabled	No	Yes
- Print Daily at Designated Time	Disabled	No	Yes
• ECM	Enabled	No	Yes
• Digital Line Network	Disabled	No	Yes
• Distinctive Ring Detection*1	Off	No	Yes
• PBX Setting*1	Disabled	No	Yes
◆ Send Settings		No	Yes
• Auto Reduction Sending Setting	Enabled	No	Yes
• Rotation Sending Setting	All Enabled	No	Yes
• Quick On Line Sending	Enabled	No	Yes
• Printing Page Number at Receiver	Enabled	No	Yes
• Default Own Number Sending	Enabled	No	Yes
• Sender Destination Name Switch	Fax No.	No	Yes
• Date/Own Number Print Position Setting	Outside the Original Image	No	Yes
• Recall in Case of Line Busy	Varies depending on country and region	No	Yes
• Recall in Case of Communication Error	Varies depending on country and region	No	Yes
• Disable Fax Broadcasting	Disabled	No	Yes
◆ Receive Settings		No	Yes
• Number of Calls in Auto Reception	2 times	No	Yes
• Switching to Automatic Reception	Disabled	No	Yes
• 2-Sided Printing of Received Data	Disabled	No	Yes
• Auto Receive Reduce Setting	Enabled	No	Yes
• Print Style Setting	Auto Size Select	No	Yes
• Set the Telephone Number for Data Forwarding	–	No	Yes
• Letter Size RX Reduce Print*1	Disabled	No	Yes
• Receiving Date & Time Print	Disabled	No	Yes
• A3 RX Reduce*1	Disabled	No	Yes
• Number of Prints	1	No	Yes
- Staple Settings*2	1 Staple at Back	No	Yes
- Paper Size	A4 or A4R (8-1/2" x 11" or 8-1/2" x 11"R)	No	Yes
◆ Allow/Reject Number Setting		No	Yes
• Allow/Reject Number Setting	All Invalid	No	Yes



Setup Items	Factory default setting	U	A
◆ Polling Setting		No	Yes
• Set Fax Polling Security	Enabled	No	Yes
◆ F-Code Memory Box	–	Yes	Yes
● Fax Data Receive/Forward (Manual) (page 7-191)		Yes	Yes
▶ Fax Settings		Yes	Yes
◆ Receive Settings	Auto Reception	Yes	Yes
◆ Multiple Set Print* ³	Disabled	Yes	Yes
◆ Staple	Disabled	Yes	Yes
◆ Forward Received Data	–	Yes	Yes

*1 This function is not available in some countries and regions.

*2 When an inner finisher, finisher, finisher (large stacker), saddle stitch finisher or saddle stitch finisher (large stacker) is installed.

*3 When the number of copies is set.

Image Send Settings

Fax Settings

You can select the image send settings of fax functions. Default Settings

The fax settings can be enabled or disabled to suit the needs of your workplace.

Resolution Setting

You can select the resolution setting for faxes.

Apply the Resolution Set when Stored

Select this to use the resolution at which the fax was sent.

If you do not select [Apply the Resolution Set when Stored], the image will be stored at the resolution specified in the pull-down menu.

Dial Mode Setting

This setting can only be activated in Canada and Taiwan.

Select the appropriate setting for your telephone line type.

Auto Wake Up Print

When the [Power] button is "Off" (but the main power switch is "On") and a fax is received, this function activates the machine and prints the fax.

When this function is disabled, received faxes are not printed until the [Power] button is switched "On".

Pause Time Setting

Changes the length of pauses inserted in fax numbers.

If a hyphen (-) is entered when dialling or storing a fax number, a pause of 2 seconds is inserted.

It can be set between 1 and 15 seconds, in every 1 seconds.

Fax Dest. Confirmation Mode

This setting specifies whether or not a destination verification message is displayed when sending a fax in order to prevent accidental transmission to the wrong destination.



Speaker Settings

Use these settings to set the sound heard from the speaker for the Speaker, Ringer Volume, Line Monitor, Fax Receive Complete Signal, Fax Send Complete Signal, and Fax Communication Error Signal. For the Fax Receive Complete Signal, the Fax Send Complete Signal, and the Fax Communication Error Signal, the Tone Pattern and Transmission Complete Sound Time Setting can be selected in addition to the volume.

Check on Setup Sounds

Checks the selected tone pattern and volume.

Remote Reception Number Setting

You can set the machine to the fax reception mode by entering a one-digit number from the connected extension telephone and by tapping the  key. This one-digit number is called the Remote Reception number, and it can be between 0 and 9.

Original Print on Transaction Report

Select one of the actions below for printing of part of the first page of the sent fax on the transaction report that is printed when memory transmission is performed.

- Print Out All Report
- Print Out Error Report Only
- No Printed Report

This setting will not be effective if the next "[Activity Report Print Select Setting \(page 7-182\)](#)" setting is set to "Do not Print".

Transaction Report Print Select Setting

Selects whether or not a transaction report will be printed, and if printed, the condition for being printed. Select a setting for each of the following operations:

Single Sending

- Print Out All Report
- Print Out Error Report Only
- No Printed Report

Broadcasting

- Print Out All Report
- Print Out Error Report Only
- No Printed Report

Receiving

- Print Out All Report
- Print Out Error Report Only
- No Printed Report

Confidential Reception

- Print Out Notice Page
- No Printed Report

When a transaction report is printed, this is used to print part of the first page of the transmitted original on the transaction report. For more information, see "[Original Print on Transaction Report \(page 7-103\)](#)".



Even if a print setting is enabled for "Receiving", a transaction report will not be printed if you receive from a number that is rejected with the "[Allow/Reject Number Setting \(page 7-188\)](#)".



Activity Report Print Select Setting

You can set the machine to periodically print the activity report that is stored in memory.

The Image Sending Activity Report can be set to print each time the number of transactions reaches 200, or at a specified time (once a day only). (The settings can be simultaneously enabled.)



- If you only select the "Print Daily at Designated Time" setting and the number of recorded transactions reaches 200 before the specified time, each new transaction will delete the oldest transaction (the oldest transaction will not be printed).
- The Transaction Report can be printed out manually as needed. For more information, see "[List for Administrator \(page 7-52\)](#)".

ECM

When you send a fax, noise on the line may occasionally cause distortion of the image. You can enable ECM (Error Correction Mode) to automatically resend only the part of the image that was distorted.



If the receiving machine is a Super G3 machine, ECM will always operate, regardless of this setting.

Digital Line Network

When this setting is enabled, the send level will be 15 dB or less when you connect to a digital line.

Distinctive Ring Detection

This Setting can only be activated in Canada, Australia, New Zealand, and Hong Kong.

If multiple telephone numbers have been assigned to your telephone line, the number called can be identified by its ringing pattern. By using one number for voice calls and another number for faxes, you can tell which type of call you are receiving by the ringing pattern. You can set your machine to automatically receive faxes when your fax number is called by setting the pattern that corresponds to your fax number. (Note that in Canada, six selections are available.)

PBX Setting

This Setting can only be activated in France and Germany.

When the machine is used on a PBX, you can enable the PBX setting to have the machine automatically connect to the outside line. When this setting is enabled, the [R] key appears in the base screen. When the [R] key is touched, the PBX setting is temporarily cancelled.

If your PBX uses the Flash method to connect to the outside line, select the [Flash]. If your PBX uses an ID number to connect to the outside line, specify the ID number.



Select a number for the first digit and then a number or a hyphen "-" for the second and third digits.



Send Settings

Settings for fax transmission can be configured.

Auto Reduction Sending Setting

This setting is used to have the size of transmitted faxes automatically reduced to match the size of the paper in the receiving machine.

If the setting is disabled, faxes are sent at full size. Because the size is not adjusted to match the size of the printing paper, part of the received fax may be cut off.

Rotation Sending Setting

When transmitting an image that is one of the following sizes, this function rotates the image 90 degrees counterclockwise. (The setting can be configured separately for each size.)

A4, B5R, A5R, 8-1/2"x11", 5-1/2"x8-1/2"R



A4R and 8-1/2" x 11"R size images are not rotated.

Quick On Line Sending

When this setting is enabled, the machine starts transmitting a fax as soon as the first page is scanned.

Transmission takes place at the same time as the remaining pages are being scanned.

Printing Page Number at Receiver

When the transmitted image is printed by the receiving machine, the page number can be added to the top of each printed page.

Default Own Number Sending

Set whether or not the date of transmission and sender's name and number are printed at the top of faxes you send.

Sender Destination Name Switch

Allows you to change the destination name and sender fax number if necessary.

Date/Own Number Print Position Setting

This setting determines the position of the date and sender information printed at the top of faxes by the receiving machine. To have the information printed outside the transmitted document image, tap the [Outside the Original Image] key. To have the information printed inside the document image, tap the [Inside the Original Image] key.

For more information on the print position, see "[ADDING YOUR SENDER INFORMATION TO FAXES \(FAX OWN NUMBER SENDING\) \(page 4-97\)](#)".

Recall in Case of Line Busy

This program is used to set the number of recall attempts and the interval between recall attempts when a transmission is not successful due to the line being busy or other reason.

Number of Times to Recall When Line is Busy

This setting specifies whether or not recalling is performed when the line is busy. When recalling is performed, you can set the number of recall attempts.

Interval to Wait Between Recall Attempts (min.) When Line is Busy

The interval between recall attempts can be set.

The number of recall attempts and the interval between attempts that can be set in each country are shown in the following table.

**Country Differentiation Table**

	The number of recall attempts	The interval between attempts
United Kingdom, France, Germany, Sweden, Italy, Spain, Netherlands, Saudi Arabia, South Africa, Hungary, Czech Republic, Slovakia, Poland, Greece, Russia	1 to 10 (default: 2)	any number of minutes from 1 to 15 (default: 3)
Canada	1 to 14 (default: 2)	
Australia, New Zealand, Singapore, Thailand, Malaysia, India, Philippines	1 to 9 (default: 2)	
Hong Kong	1 to 3 (default: 2)	
Taiwan	1 to 15 (default: 2)	any number of minutes from 4 to 15 (default: 4)
Indonesia	1 to 5 (default: 2)	



When this setting is enabled, note that the machine will not attempt the call again when manual transmission or direct transmission is used.

Recall in Case of Communication Error

This determines how many times your machine will automatically re-attempt the call if a fax transmission fails due to a communication error.

Number of Times to Recall in Case of Error

Specify how many times the machine will re-attempt the call when a communication error occurs.

Interval to Wait Between Recall Attempts (min.) in Case of Error

The interval between recall attempts can be set.

The number of recall attempts and the interval between attempts that can be set in each country are shown in the following table.

Country Differentiation Table

	The number of recall attempts	The interval between attempts
United Kingdom, France, Germany, Sweden, Italy, Spain, Netherlands, Saudi Arabia, South Africa, Hungary, Czech Republic, Slovakia, Poland, Greece, Russia	1 to 5 (default: 1)	any number of minutes from 1 to 15 (default: 3)
Australia, New Zealand, Canada	1 attempt	any number of minutes from 1 to 15 (default: 3)



	The number of recall attempts	The interval between attempts
Singapore, Thailand, Malaysia, India, Philippines	1 to 9 (default: 2)	any number of minutes from 1 to 15 (default: 1)
Hong Kong	1 to 3 (default: 2)	
Taiwan	1 to 15 (default: 2)	
Indonesia	1 to 5 (default: 2)	any number of minutes from 4 to 15 (default: 4)



When this setting is enabled, note that your machine will not re-attempt a call when manual transmission or direct transmission is used.

Disable Fax Broadcasting

Disables facsimile broadcasting.

Receive Settings

Settings for fax transmission can be configured.

Number of Calls in Auto Reception

This setting is used to select the number of rings on which the machine automatically receives a call and begins fax reception in auto reception mode.

The "Number of Calls in Auto Reception" that can be set in each country are shown in the following table.

Country Differentiation Table

	The number of rings
United Kingdom, France, Germany, Sweden, Italy, Spain, Netherlands, Thailand, Hong Kong, Saudi Arabia, South Africa, Hungary, Czech Republic, Slovakia, Poland, Greece, Russia, Philippines, Indonesia	0 to 9
Australia, New Zealand	2 to 4
Singapore	0 to 3
Malaysia, India, Canada, Taiwan	0 to 15



If you select "0" for the number of rings, the machine will immediately answer and begin fax reception without ringing in auto reception mode.

2-Sided Printing of Received Data

This is used to have received faxes printed on both sides of the paper.

When this setting is enabled and a fax consisting of 2 or more pages is received (the pages must be the same size), the pages are printed on both sides of the paper.



Auto Receive Reduce Setting

When a fax is received that includes printed information such as the sender's name and address, the received image is slightly larger than the standard size. This setting is used to automatically reduce the image to fit the standard size.



- If Auto Receive Reduce is disabled, the edges of the image outside the standard size will be cut off. However, the image will be clearer because it will be printed at the same size as the original.
- Standard sizes are sizes such as A4 and B5 (8-1/2" x 11" and 8-1/2" x 5-1/2").

Print Style Setting

This setting determines the paper selection condition when printing received faxes. Select one of the three conditions below.

Print Actual Size Cut off Disabled

The received fax image is printed at full size without dividing it onto multiple sheets of paper. If the same size of paper or larger paper is not loaded, the fax will be received in memory and will not be printed until a suitable size of paper is loaded.

However, if the received fax is longer than A3 (11" x 17") size, it will be automatically divided onto multiple sheets of paper.

Print Actual Size Cut off Enabled

Each received image is printed at full size. If necessary, the image is divided onto multiple sheets of paper.

Auto Size Select

Each received image is printed at full size when possible. When not possible, the image is automatically reduced before printing.

Set the Telephone Number for Data Forwarding

When a problem prevents the machine from printing a received fax, the received fax can be forwarded to another fax machine. This setting is used to program the fax number of the destination fax machine. Only one forwarding fax number can be programmed (maximum of 64 digits).

To insert a pause between digits of the number, tap the [-] key.

If you wish to specify an F-code confidential memory box in the destination machine, tap the [/] key after entering the fax number and enter the F-code (sub-address and passcode).

Letter Size RX Reduce Print

This program is not available in Canada and Philippines.

When a letter-R (8-1/2" x 11"R) size fax is received, this setting reduces the fax to A4R size.



When this setting is enabled, A4R size faxes are also reduced.

Receiving Date & Time Print

Enable this setting to have the date and time of reception printed.

Select [Inside the Received Image] or [Outside the Received Image] for the position where the date and time is printed.

When [Inside the Received Image] is selected, the date and time of reception is printed on the received image.

When [Outside the Received Image] is selected, the received image is reduced and the date and time of reception is printed in the blank area that results.



The [Outside the Received Image] cannot be selected for the reception date and time print setting if "[Auto Receive Reduce Setting \(page 7-186\)](#)" is not enabled.

A3 RX Reduce

When an A3 size fax is received, this function reduces the fax to ledger (11" x 17") size.



When this setting is enabled, ledger (11" x 17") size faxes are also reduced.



Fax Output Settings

These settings are used to select the number of copies and output tray for received faxes. When a finisher is installed, the finisher tray can be selected as the output tray and stapling can be selected.

Output Tray

Select the output tray for received faxes.

Number of Prints

Set the number of copies of received faxes that are printed to any number from 1 to 99.

Staple Settings

When a finisher is installed, set the position at which received faxes are stapled.

Paper Size

When a finisher is installed, select the paper used for printing of received faxes.



This setting can only be used when the [Multiple Set Print] and [Staple] checkboxes are selected .

The maximum number of sheets that can be stapled is 50. (When the paper is oriented horizontally, the maximum number of sheets that can be stapled is 30.)



Allow/Reject Number Setting

Use this setting to specify whether reception from a stored number is to be allowed or rejected.

Item	Settings
Rejected	Reject reception from the stored number.
Allow Reception	Allow reception from the stored number.
All Invalid	Even if numbers have been stored, disregard the numbers and allow reception from all numbers.
Add New	Adds a new address or domain (maximum of 50) from which reception is to be rejected or allowed. Enter the number (maximum of 20 digits) and tap the [Store] key.
Registration Number List	A list of the stored numbers can be displayed. When you select a number from this screen, it is deleted from the list.
Reject hidden Number	If checked, any call from the number of Reject Unknown Calls setting is rejected, regardless of the certain number receive settings.

Reject hidden Number

Rejects a call if the caller has blocked the sending of caller identification information.



When there are no stored anti junk mail addresses or domains, only the [Add New] key can be selected.



Polling Setting

The following settings are for regular polling memory using the Public Box.

Set Fax Polling Security

When the memory polling function is used, this setting determines whether any machine will be allowed to poll your machine, or only machines that have been stored in your machine.

Add New

When the Polling Security Setting is enabled, use this setting to store (or delete) the fax numbers of the machines that are allowed to poll your machine. Up to 10 destination fax numbers can be stored. Each number must be within 20 digits in length.

Passcode Number Key List

This shows a list of the stored passcode numbers. Select a number from the list and delete it.



Note that these settings do not apply to F-code polling memory.



F-Code Memory Box

This section explains how to store memory boxes for various types of F-code communication.

Storing a memory box

When you tap the [Add New] key, the registration screen appears. Up to 100 F-code memory boxes can be stored for all functions (polling memory, confidential, and relay broadcast).

Editing and deleting a memory box

When you select a memory box from the list, the edit screen appears for the box.

For information on the settings, see the following table.

Tap the [Delete] key to delete the memory box.

Settings

Item	Settings
Items common to all types	
Box Type	<p>Select the type of box.</p> <ul style="list-style-type: none"> • Polling Memory: Store a memory box for F-code polling memory. The sub-address and passcode that you store in the memory box are necessary for the other machine to poll the machine (request transmission) using F-code communication. • Confidential: Store a memory box for F-code confidential communication. In addition, store a "Print PIN" in the memory box to print faxes received by confidential reception. The sub-address and passcode that you program in the memory box are necessary for the other machine to send a fax to the machine by F-code confidential transmission. • Relay Broadcast: Store a memory box for F-code relay broadcast transmission. Up to 30 destinations can be stored to forward the received data. The sub-address and passcode that you program in the memory box are necessary for the other machine to send a fax to the machine by F-code relay request transmission.
Memory Box Name	Enter a name (maximum of 18 characters) for the memory box.
Sub Address / Passcode	Enter a sub-address and passcode. A maximum of 20 digits can be entered for each sub-address and passcode. Separate a sub-address and passcode by a slash ("/").
Items displayed when storing a confidential memory box	
Print PIN	Set a "Print PIN" for confidential reception. Enter a 4-digit number.
Items displayed when storing a relay broadcast memory box	
Forward Destination	<p>Select the end recipients of the relay broadcast.</p> <ul style="list-style-type: none"> • Select the recipients from the address book. • Select Forward Address from the Address: Select an address from the address book. • Destination Entry: An address that is not stored in the address book can be directly entered. Enter the address in the same way as when storing an address for a mode.



- When programming a new memory box, a sub-address that is already programmed for another box cannot be used. However, the same passcode can be used for more than one memory box.
- [*] and [#] cannot be used in a sub-address.
- A passcode can be omitted.
- Do not forget the Print PIN. In the event that you forget the Print PIN or need to verify the Print PIN, contact your dealer or nearest authorised service representative.



Fax Data Receive/Forward (Manual)

This section explains settings for fax reception and forwarding.

Fax Settings

Item	Settings
Receive Settings	<p>Set the fax reception method. Auto Reception: When a call comes in, the machine rings and then automatically begins fax reception.</p> <ul style="list-style-type: none">• Auto Reception: When a call comes in, the machine rings and then automatically begins fax reception.• Manual Reception: Used when an existing extension telephone is connected to the machine. You can answer to a phone call first, and then receive a fax by manual operation.
Multiple Set Print	Specify whether or not two or more copies of received faxes will be printed. The number of copies can be set with the "Fax Output Settings".
Staple	Specify whether or not stapling is performed. (Only when a finisher is installed)
Forward Received Data	When the machine cannot print because it is out of paper or out of toner, received faxes can be forwarded to another previously stored fax machine.



- If there is no forwarding data or if the destination is not registered, no data is forwarded.
- If "[Hold Setting for Received Data Print \(page 7-94\)](#)" is enabled, you are prompted to enter a password. Enter the correct password using numeric keys.
- If some pages of a fax that is being forwarded were successfully printed, only those pages that were not printed will be forwarded.
- A forwarded fax becomes a fax transmission job. If transmission does not take place because the transmission was cancelled or an error occurred, the fax will be held in memory until it can be printed.
- All faxes received are forwarded. Note that the received data stored in the F-code confidential memory box is not forwarded.
- For destination number registration, see "[Set the Telephone Number for Data Forwarding \(page 7-186\)](#)".

LICENSE INFORMATION

Information on the Software License for This Product

Software composition

The software included in this product is comprised of various software components whose individual copyrights are held by SHARP or by third parties.

Software developed by SHARP and open source software

The copyrights for the software components and various relevant documents included with this product that were developed or written by SHARP are owned by SHARP and are protected by the Copyright Act, international treaties, and other relevant laws. This product also makes use of freely distributed software and software components whose copyrights are held by third parties. These include software components covered by a GNU General Public License (hereafter GPL), a GNU Lesser General Public License (hereafter LGPL) or other license agreement.

Obtaining source code

Some of the open source software licensors require the distributor to provide the source code with the executable software components. GPL and LGPL include similar requirements. For information on obtaining the source code for the open source software and for obtaining the GPL, LGPL, and other license agreement information, visit the following website:

<http://sharp-world.com/products/copier/source/download/index.html>

We are unable to answer any questions about the source code for the open source software. The source code for the software components whose copyrights are held by SHARP is not distributed.

Software Copyrights

Copyright (c) 2000 Carnegie Mellon University. All rights reserved.

Redistribution and use in source and binary forms, with or without modification, are permitted provided that the following conditions are met:

- 1.Redistributions of source code must retain the above copyright notice, this list of conditions and the following disclaimer.
- 2.Redistributions in binary form must reproduce the above copyright notice, this list of conditions and the following disclaimer in the documentation and/or other materials provided with the distribution.
- 3.The name "Carnegie Mellon University" must not be used to endorse or promote products derived from this software without prior written permission. For permission or any other legal details, please contact
Office of Technology Transfer Carnegie Mellon University 5000 Forbes Avenue Pittsburgh, PA 15213-3890
(412) 268-4387, fax: (412) 268-7395
tech-transfer@andrew.cmu.edu
- 4.Redistributions of any form whatsoever must retain the following acknowledgment:
"This product includes software developed by Computing Services at Carnegie Mellon University
(<http://www.cmu.edu/computing/>)."

CARNEGIE MELLON UNIVERSITY DISCLAIMS ALL WARRANTIES WITH REGARD TO THIS SOFTWARE, INCLUDING ALL IMPLIED WARRANTIES OF MERCHANTABILITY AND FITNESS, IN NO EVENT SHALL CARNEGIE MELLON UNIVERSITY BE LIABLE FOR ANY SPECIAL, INDIRECT OR CONSEQUENTIAL DAMAGES OR ANY DAMAGES WHATSOEVER RESULTING FROM LOSS OF USE, DATA OR PROFITS, WHETHER IN AN ACTION OF CONTRACT, NEGLIGENCE OR OTHER TORTIOUS ACTION, ARISING OUT OF OR IN CONNECTION WITH THE USE OR PERFORMANCE OF THIS SOFTWARE.

Copyright (c) 1995 - 2008 Kungliga Tekniska Högskolan (Royal Institute of Technology, Stockholm, Sweden). All rights reserved.

All rights reserved. Export of this software from the United States of America may require a specific license from the United States Government. It is the responsibility of any person or organization contemplating export to obtain such a license before exporting.

WITHIN THAT CONSTRAINT, permission to use, copy, modify, and distribute this software and its documentation for any purpose and without fee is hereby granted, provided that the above copyright notice appear in all copies and that both that copyright notice and this permission notice appear in supporting documentation, and that the name of M.I.T. not be used in advertising or publicity pertaining to distribution of the software without specific, written prior permission. Furthermore if you modify this software you must label your software as modified software and not distribute it in such a fashion that it might be confused with the original MIT software. M.I.T. makes no representations about the suitability of this software for any purpose. It is provided "as is" without express or implied warranty.

THIS SOFTWARE IS PROVIDED "**AS IS**" AND WITHOUT ANY EXPRESS OR IMPLIED WARRANTIES, INCLUDING, WITHOUT LIMITATION, THE IMPLIED WARRANTIES OF MERCHANTABILITY AND FITNESS FOR A PARTICULAR PURPOSE.

Individual source code files are copyright MIT, Cygnus Support, OpenVision, Oracle, Sun Soft, FundsXpress, and others.

Project Athena, Athena, Athena MUSE, Discuss, Hesiod, Kerberos, Moira, and Zephyr are trademarks of the Massachusetts Institute of Technology (MIT). No commercial use of these trademarks may be made without prior written permission of MIT.

"Commercial use" means use of a name in a product or other for-profit manner. It does NOT prevent a commercial firm from referring to the MIT trademarks in order to convey information (although in doing so, recognition of their trademark status should be given).

OpenSSL License

Copyright (c) 1998-2004 The OpenSSL Project. All rights reserved.

Redistribution and use in source and binary forms, with or without modification, are permitted provided that the following conditions are met:

- 1.Redistributions of source code must retain the above copyright notice, this list of conditions and the following disclaimer.
- 2.Redistributions in binary form must reproduce the above copyright notice, this list of conditions and the following disclaimer in the documentation and/or other materials provided with the distribution.
- 3.All advertising materials mentioning features or use of this software must display the following acknowledgment: "This product includes software developed by the OpenSSL Project for use in the OpenSSL Toolkit. (<http://www.openssl.org/>)"
- 4.The names "OpenSSL Toolkit" and "OpenSSL Project" must not be used to endorse or promote products derived from this software without prior written permission. For written permission, please contact openssl-core@openssl.org.
- 5.Products derived from this software may not be called "OpenSSL" nor may "OpenSSL" appear in their names without prior written permission of the OpenSSL Project.
- 6.Redistributions of any form whatsoever must retain the following acknowledgment: "This product includes software developed by the OpenSSL Project for use in the OpenSSL Toolkit. (<http://www.openssl.org/>)"

THIS SOFTWARE IS PROVIDED BY THE OpenSSL PROJECT "AS IS" AND ANY EXPRESSED OR IMPLIED WARRANTIES, INCLUDING, BUT NOT LIMITED TO, THE IMPLIED WARRANTIES OF MERCHANTABILITY AND FITNESS FOR A PARTICULAR PURPOSE ARE DISCLAIMED. IN NO EVENT SHALL THE OpenSSL PROJECT OR ITS CONTRIBUTORS BE LIABLE FOR ANY DIRECT, INDIRECT, INCIDENTAL, SPECIAL, EXEMPLARY, OR CONSEQUENTIAL DAMAGES (INCLUDING, BUT NOT LIMITED TO, PROCUREMENT OF SUBSTITUTE GOODS OR SERVICES; LOSS OF USE, DATA, OR PROFITS; OR BUSINESS INTERRUPTION) HOWEVER CAUSED AND ON ANY THEORY OF LIABILITY, WHETHER IN CONTRACT, STRICT LIABILITY, OR TORT (INCLUDING NEGLIGENCE OR OTHERWISE) ARISING IN ANY WAY OUT OF THE USE OF THIS SOFTWARE, EVEN IF ADVISED OF THE POSSIBILITY OF SUCH DAMAGE.

This product includes cryptographic software written by Eric Young (eay@cryptsoft.com). This product includes software written by Tim Hudson (tjh@cryptsoft.com).

Original SSLeay License

Copyright (C) 1995-1998 Eric Young (eay@cryptsoft.com) All rights reserved.

This package is an SSL implementation written by Eric Young (eay@cryptsoft.com). The implementation was written so as to conform with Netscape's SSL.

This library is free for commercial and non-commercial use as long as the following conditions are adhered to. The following conditions apply to all code found in this distribution, be it the RC4, RSA, lhash, DES, etc., code; not just the SSL code. The SSL documentation included with this distribution is covered by the same copyright terms except that the holder is Tim Hudson (tjh@cryptsoft.com).

Copyright remains Eric Young's, and as such any Copyright notices in the code are not to be removed. If this package is used in a product, Eric Young should be given attribution as the author of the parts of the library used. This can be in the form of a textual message at program startup or in documentation (online or textual) provided with the package.

Redistribution and use in source and binary forms, with or without modification, are permitted provided that the following conditions are met:

1. Redistributions of source code must retain the copyright notice, this list of conditions and the following disclaimer.
2. Redistributions in binary form must reproduce the above copyright notice, this list of conditions and the following disclaimer in the documentation and/or other materials provided with the distribution.
3. All advertising materials mentioning features or use of this software must display the following acknowledgement:
"This product includes cryptographic software written by Eric Young (eay@cryptsoft.com)" The word 'cryptographic' can be left out if the routines from the library being used are not cryptographic related :-).
4. If you include any Windows specific code (or a derivative thereof) from the apps directory (application code) you must include an acknowledgement: "This product includes software written by Tim Hudson (tjh@cryptsoft.com)"

THIS SOFTWARE IS PROVIDED BY ERIC YOUNG "AS IS" AND ANY EXPRESS OR IMPLIED WARRANTIES, INCLUDING, BUT NOT LIMITED TO, THE IMPLIED WARRANTIES OF MERCHANTABILITY AND FITNESS FOR A PARTICULAR PURPOSE ARE DISCLAIMED. IN NO EVENT SHALL THE AUTHOR OR CONTRIBUTORS BE LIABLE FOR ANY DIRECT, INDIRECT, INCIDENTAL, SPECIAL, EXEMPLARY, OR CONSEQUENTIAL DAMAGES (INCLUDING, BUT NOT LIMITED TO, PROCUREMENT OF SUBSTITUTE GOODS OR SERVICES; LOSS OF USE, DATA, OR PROFITS; OR BUSINESS INTERRUPTION) HOWEVER CAUSED AND ON ANY THEORY OF LIABILITY, WHETHER IN CONTRACT, STRICT LIABILITY, OR TORT (INCLUDING NEGLIGENCE OR OTHERWISE) ARISING IN ANY WAY OUT OF THE USE OF THIS SOFTWARE, EVEN IF ADVISED OF THE POSSIBILITY OF SUCH DAMAGE.

The licence and distribution terms for any publically available version or derivative of this code cannot be changed. i.e. this code cannot simply be copied and put under another distribution licence [including the GNU Public Licence.]

D3DES License

Copyright (c) 1988,1989,1990,1991,1992 by Richard Outerbridge. (GENIE : OUTER; CIS : [71755,204]) Graven Imagery, 1992.

GNU GENERAL PUBLIC LICENSE Version 2, June 1991

Copyright (C) 1989, 1991 Free Software Foundation, Inc., 51 Franklin Street, Fifth Floor, Boston, MA 02110-1301 USA Everyone is permitted to copy and distribute verbatim copies of this license document, but changing it is not allowed.

Preamble

The licenses for most software are designed to take away your freedom to share and change it. By contrast, the GNU General Public License is intended to guarantee your freedom to share and change free software--to make sure the software is free for all its users. This General Public License applies to most of the Free Software Foundation's software and to any other program whose authors commit to using it. (Some other Free Software Foundation software is covered by the GNU Lesser General Public License instead.) You can apply it to your programs, too.

When we speak of free software, we are referring to freedom, not price. Our General Public Licenses are designed to make sure that you have the freedom to distribute copies of free software (and charge for this service if you wish), that you receive source code or can get it if you want it, that you can change the software or use pieces of it in new free programs; and that you know you can do these things.

To protect your rights, we need to make restrictions that forbid anyone to deny you these rights or to ask you to surrender the rights. These restrictions translate to certain responsibilities for you if you distribute copies of the software, or if you modify it.

For example, if you distribute copies of such a program, whether gratis or for a fee, you must give the recipients all the rights that you have. You must make sure that they, too, receive or can get the source code. And you must show them these terms so they know their rights.

We protect your rights with two steps: (1) copyright the software, and (2) offer you this license which gives you legal permission to copy, distribute and/or modify the software.

Also, for each author's protection and ours, we want to make certain that everyone understands that there is no warranty for this free software. If the software is modified by someone else and passed on, we want its recipients to know that what they have is not the original, so that any problems introduced by others will not reflect on the original authors' reputations.

Finally, any free program is threatened constantly by software patents. We wish to avoid the danger that redistributors of a free program will individually obtain patent licenses, in effect making the program proprietary. To prevent this, we have made it clear that any patent must be licensed for everyone's free use or not licensed at all.

The precise terms and conditions for copying, distribution and modification follow.

GNU GENERAL PUBLIC LICENSE TERMS AND CONDITIONS FOR COPYING, DISTRIBUTION AND MODIFICATION

0. This License applies to any program or other work which contains a notice placed by the copyright holder saying it may be distributed under the terms of this General Public License. The "Program", below, refers to any such program or work, and a "work based on the Program" means either the Program or any derivative work under copyright law: that is to say, a work containing the Program or a portion of it, either verbatim or with modifications and/or translated into another language. (Hereinafter, translation is included without limitation in the term "modification".) Each licensee is addressed as "you".

Activities other than copying, distribution and modification are not covered by this License; they are outside its scope. The act of running the Program is not restricted, and the output from the Program is covered only if its contents constitute a work based on the Program (independent of having been made by running the Program). Whether that is true depends on what the Program does.

1. You may copy and distribute verbatim copies of the Program's source code as you receive it, in any medium, provided that you conspicuously and appropriately publish on each copy an appropriate copyright notice and disclaimer of warranty; keep intact all the notices that refer to this License and to the absence of any warranty; and give any other recipients of the Program a copy of this License along with the Program.

You may charge a fee for the physical act of transferring a copy, and you may at your option offer warranty protection in exchange for a fee.

2. You may modify your copy or copies of the Program or any portion of it, thus forming a work based on the Program, and copy and distribute such modifications or work under the terms of Section 1 above, provided that you also meet all of these conditions:

- a) You must cause the modified files to carry prominent notices stating that you changed the files and the date of any change.
- b) You must cause any work that you distribute or publish, that in whole or in part contains or is derived from the Program or any part thereof, to be licensed as a whole at no charge to all third parties under the terms of this License.
- c) If the modified program normally reads commands interactively when run, you must cause it, when started running for such interactive use in the most ordinary way, to print or display an announcement including an appropriate copyright notice and a notice that there is no warranty (or else, saying that you provide a warranty) and that users may redistribute the program under these conditions, and telling the user how to view a copy of this License. (Exception: if the Program itself is interactive but does not normally print such an announcement, your work based on the Program is not required to print an announcement.)

These requirements apply to the modified work as a whole. If identifiable sections of that work are not derived from the Program, and can be reasonably considered independent and separate works in themselves, then this License, and its terms, do not apply to those sections when you distribute them as separate works. But when you distribute the same

sections as part of a whole which is a work based on the Program, the distribution of the whole must be on the terms of this License, whose permissions for other licensees extend to the entire whole, and thus to each and every part regardless of who wrote it.

Thus, it is not the intent of this section to claim rights or contest your rights to work written entirely by you; rather, the intent is to exercise the right to control the distribution of derivative or collective works based on the Program.

In addition, mere aggregation of another work not based on the Program with the Program (or with a work based on the Program) on a volume of a storage or distribution medium does not bring the other work under the scope of this License.

3. You may copy and distribute the Program (or a work based on it, under Section 2) in object code or executable form under the terms of Sections 1 and 2 above provided that you also do one of the following:

- a) Accompany it with the complete corresponding machine-readable source code, which must be distributed under the terms of Sections 1 and 2 above on a medium customarily used for software interchange; or,
- b) Accompany it with a written offer, valid for at least three years, to give any third party, for a charge no more than your cost of physically performing source distribution, a complete machine-readable copy of the corresponding source code, to be distributed under the terms of Sections 1 and 2 above on a medium customarily used for software interchange; or,
- c) Accompany it with the information you received as to the offer to distribute corresponding source code. (This alternative is allowed only for noncommercial distribution and only if you received the program in object code or executable form with such an offer, in accord with Subsection b above.)

The source code for a work means the preferred form of the work for making modifications to it. For an executable work, complete source code means all the source code for all modules it contains, plus any associated interface definition files, plus the scripts used to control compilation and installation of the executable. However, as a special exception, the source code distributed need not include anything that is normally distributed (in either source or binary form) with the major components (compiler, kernel, and so on) of the operating system on which the executable runs, unless that component itself accompanies the executable.

If distribution of executable or object code is made by offering access to copy from a designated place, then offering equivalent access to copy the source code from the same place counts as distribution of the source code, even though third parties are not compelled to copy the source along with the object code.

4. You may not copy, modify, sublicense, or distribute the Program except as expressly provided under this License. Any attempt otherwise to copy, modify, sublicense or distribute the Program is void, and will automatically terminate your rights under this License. However, parties who have received copies, or rights, from you under this License will not have their licenses terminated so long as such parties remain in full compliance.

5. You are not required to accept this License, since you have not signed it. However, nothing else grants you permission to modify or distribute the Program or its derivative works. These actions are prohibited by law if you do not accept this License. Therefore, by modifying or distributing the Program (or any work based on the Program), you indicate your acceptance of this License to do so, and all its terms and conditions for copying, distributing or modifying the Program or works based on it.

6. Each time you redistribute the Program (or any work based on the Program), the recipient automatically receives a license from the original licensor to copy, distribute or modify the Program subject to these terms and conditions. You

may not impose any further restrictions on the recipients' exercise of the rights granted herein. You are not responsible for enforcing compliance by third parties to this License.

7. If, as a consequence of a court judgment or allegation of patent infringement or for any other reason (not limited to patent issues), conditions are imposed on you (whether by court order, agreement or otherwise) that contradict the conditions of this License, they do not excuse you from the conditions of this License. If you cannot distribute so as to satisfy simultaneously your obligations under this License and any other pertinent obligations, then as a consequence you may not distribute the Program at all. For example, if a patent license would not permit royalty-free redistribution of the Program by all those who receive copies directly or indirectly through you, then the only way you could satisfy both it and this License would be to refrain entirely from distribution of the Program.

If any portion of this section is held invalid or unenforceable under any particular circumstance, the balance of the section is intended to apply and the section as a whole is intended to apply in other circumstances.

It is not the purpose of this section to induce you to infringe any patents or other property right claims or to contest validity of any such claims; this section has the sole purpose of protecting the integrity of the free software distribution system, which is implemented by public license practices. Many people have made generous contributions to the wide range of software distributed through that system in reliance on consistent application of that system; it is up to the author/donor to decide if he or she is willing to distribute software through any other system and a licensee cannot impose that choice.

This section is intended to make thoroughly clear what is believed to be a consequence of the rest of this License.

8. If the distribution and/or use of the Program is restricted in certain countries either by patents or by copyrighted interfaces, the original copyright holder who places the Program under this License may add an explicit geographical distribution limitation excluding those countries, so that distribution is permitted only in or among countries not thus excluded. In such case, this License incorporates the limitation as if written in the body of this License.

9. The Free Software Foundation may publish revised and/or new versions of the General Public License from time to time. Such new versions will be similar in spirit to the present version, but may differ in detail to address new problems or concerns.

Each version is given a distinguishing version number. If the Program specifies a version number of this License which applies to it and "any later version", you have the option of following the terms and conditions either of that version or of any later version published by the Free Software Foundation. If the Program does not specify a version number of this License, you may choose any version ever published by the Free Software Foundation.

10. If you wish to incorporate parts of the Program into other free programs whose distribution conditions are different, write to the author to ask for permission. For software which is copyrighted by the Free Software Foundation, write to the Free Software Foundation; we sometimes make exceptions for this. Our decision will be guided by the two goals of preserving the free status of all derivatives of our free software and of promoting the sharing and reuse of software generally.

NO WARRANTY

11. BECAUSE THE PROGRAM IS LICENSED FREE OF CHARGE, THERE IS NO WARRANTY FOR THE PROGRAM, TO THE EXTENT PERMITTED BY APPLICABLE LAW. EXCEPT WHEN OTHERWISE STATED IN WRITING THE COPYRIGHT HOLDERS AND/OR OTHER PARTIES PROVIDE THE PROGRAM "AS IS" WITHOUT WARRANTY OF ANY KIND, EITHER EXPRESSED OR IMPLIED, INCLUDING, BUT NOT LIMITED TO, THE IMPLIED WARRANTIES OF MERCHANTABILITY AND FITNESS FOR A PARTICULAR PURPOSE. THE ENTIRE RISK AS TO

THE QUALITY AND PERFORMANCE OF THE PROGRAM IS WITH YOU. SHOULD THE PROGRAM PROVE DEFECTIVE, YOU ASSUME THE COST OF ALL NECESSARY SERVICING, REPAIR OR CORRECTION.

12. IN NO EVENT UNLESS REQUIRED BY APPLICABLE LAW OR AGREED TO IN WRITING WILL ANY COPYRIGHT HOLDER, OR ANY OTHER PARTY WHO MAY MODIFY AND/OR REDISTRIBUTE THE PROGRAM AS PERMITTED ABOVE, BE LIABLE TO YOU FOR DAMAGES, INCLUDING ANY GENERAL, SPECIAL, INCIDENTAL OR CONSEQUENTIAL DAMAGES ARISING OUT OF THE USE OR INABILITY TO USE THE PROGRAM (INCLUDING BUT NOT LIMITED TO LOSS OF DATA OR DATA BEING RENDERED INACCURATE OR LOSSES SUSTAINED BY YOU OR THIRD PARTIES OR A FAILURE OF THE PROGRAM TO OPERATE WITH ANY OTHER PROGRAMS), EVEN IF SUCH HOLDER OR OTHER PARTY HAS BEEN ADVISED OF THE POSSIBILITY OF SUCH DAMAGES.

END OF TERMS AND CONDITIONS

How to Apply These Terms to Your New Programs

If you develop a new program, and you want it to be of the greatest possible use to the public, the best way to achieve this is to make it free software which everyone can redistribute and change under these terms.

To do so, attach the following notices to the program. It is safest to attach them to the start of each source file to most effectively convey the exclusion of warranty; and each file should have at least the "copyright" line and a pointer to where the full notice is found.

<one line to give the program's name and a brief idea of what it does.> Copyright (C) <year> <name of author>

This program is free software; you can redistribute it and/or modify it under the terms of the GNU General Public License as published by the Free Software Foundation; either version 2 of the License, or (at your option) any later version.

This program is distributed in the hope that it will be useful, but WITHOUT ANY WARRANTY; without even the implied warranty of MERCHANTABILITY or FITNESS FOR A PARTICULAR PURPOSE. See the GNU General Public License for more details.

You should have received a copy of the GNU General Public License along with this program; if not, write to the Free Software Foundation, Inc., 51 Franklin Street, Fifth Floor, Boston, MA 02110-1301 USA.

Also add information on how to contact you by electronic and paper mail.

If the program is interactive, make it output a short notice like this when it starts in an interactive mode:

Gnomovision version 69, Copyright (C) year name of author Gnomovision comes with ABSOLUTELY NO WARRANTY; for details type `show w'. This is free software, and you are welcome to redistribute it under certain conditions; type `show c' for details.

The hypothetical commands `show w' and `show c' should show the appropriate parts of the General Public License. Of course, the commands you use may be called something other than `show w' and `show c'; they could even be mouse-clicks or menu items--whatever suits your program.

You should also get your employer (if you work as a programmer) or your school, if any, to sign a "copyright disclaimer" for the program, if necessary. Here is a sample; alter the names:

Yoyodyne, Inc., hereby disclaims all copyright interest in the program `Gnomovision' (which makes passes at compilers) written by James Hacker.

<signature of Ty Coon>, 1 April 1989
Ty Coon, President of Vice

This General Public License does not permit incorporating your program into proprietary programs. If your program is a subroutine library, you may consider it more useful to permit linking proprietary applications with the library. If this is what you want to do, use the GNU Lesser General Public License instead of this License.

GNU LESSER GENERAL PUBLIC LICENSE

Version 2.1, February 1999

Copyright (C) 1991, 1999 Free Software Foundation, Inc. 51 Franklin Street, Fifth Floor, Boston, MA 02110-1301 USA Everyone is permitted to copy and distribute verbatim copies of this license document, but changing it is not allowed.

[This is the first released version of the Lesser GPL. It also counts as the successor of the GNU Library Public License, version 2, hence the version number 2.1.]

Preamble

The licenses for most software are designed to take away your freedom to share and change it. By contrast, the GNU General Public Licenses are intended to guarantee your freedom to share and change free software--to make sure the software is free for all its users.

This license, the Lesser General Public License, applies to some specially designated software packages--typically libraries--of the Free Software Foundation and other authors who decide to use it. You can use it too, but we suggest you first think carefully about whether this license or the ordinary General Public License is the better strategy to use in any particular case, based on the explanations below.

When we speak of free software, we are referring to freedom of use, not price. Our General Public Licenses are designed to make sure that you have the freedom to distribute copies of free software (and charge for this service if you wish); that you receive source code or can get it if you want it; that you can change the software and use pieces of it in new free programs; and that you are informed that you can do these things.

To protect your rights, we need to make restrictions that forbid distributors to deny you these rights or to ask you to surrender these rights. These restrictions translate to certain responsibilities for you if you distribute copies of the library or if you modify it.

For example, if you distribute copies of the library, whether gratis or for a fee, you must give the recipients all the rights that we gave you. You must make sure that they, too, receive or can get the source code. If you link other code with the

library, you must provide complete object files to the recipients, so that they can relink them with the library after making changes to the library and recompiling it. And you must show them these terms so they know their rights.

We protect your rights with a two-step method: (1) we copyright the library, and (2) we offer you this license, which gives you legal permission to copy, distribute and/or modify the library.

To protect each distributor, we want to make it very clear that there is no warranty for the free library. Also, if the library is modified by someone else and passed on, the recipients should know that what they have is not the original version, so that the original author's reputation will not be affected by problems that might be introduced by others.

Finally, software patents pose a constant threat to the existence of any free program. We wish to make sure that a company cannot effectively restrict the users of a free program by obtaining a restrictive license from a patent holder. Therefore, we insist that any patent license obtained for a version of the library must be consistent with the full freedom of use specified in this license.

Most GNU software, including some libraries, is covered by the ordinary GNU General Public License. This license, the GNU Lesser General Public License, applies to certain designated libraries, and is quite different from the ordinary General Public License. We use this license for certain libraries in order to permit linking those libraries into non-free programs.

When a program is linked with a library, whether statically or using a shared library, the combination of the two is legally speaking a combined work, a derivative of the original library. The ordinary General Public License therefore permits such linking only if the entire combination fits its criteria of freedom. The Lesser General Public License permits more lax criteria for linking other code with the library.

We call this license the "Lesser" General Public License because it does Less to protect the user's freedom than the ordinary General Public License. It also provides other free software developers Less of an advantage over competing non-free programs. These disadvantages are the reason we use the ordinary General Public License for many libraries. However, the Lesser license provides advantages in certain special circumstances.

For example, on rare occasions, there may be a special need to encourage the widest possible use of a certain library, so that it becomes a de-facto standard. To achieve this, non-free programs must be allowed to use the library. A more frequent case is that a free library does the same job as widely used non-free libraries. In this case, there is little to gain by limiting the free library to free software only, so we use the Lesser General Public License.

In other cases, permission to use a particular library in non-free programs enables a greater number of people to use a large body of free software. For example, permission to use the GNU C Library in non-free programs enables many more people to use the whole GNU operating system, as well as its variant, the GNU/Linux operating system.

Although the Lesser General Public License is Less protective of the users' freedom, it does ensure that the user of a program that is linked with the Library has the freedom and the wherewithal to run that program using a modified version of the Library.

The precise terms and conditions for copying, distribution and modification follow. Pay close attention to the difference between a "work based on the library" and a "work that uses the library". The former contains code derived from the library, whereas the latter must be combined with the library in order to run.

GNU LESSER GENERAL PUBLIC LICENSE TERMS AND CONDITIONS FOR COPYING, DISTRIBUTION AND MODIFICATION

0. This License Agreement applies to any software library or other program which contains a notice placed by the copyright holder or other authorized party saying it may be distributed under the terms of this Lesser General Public License (also called "this License"). Each licensee is addressed as "you".

A "library" means a collection of software functions and/or data prepared so as to be conveniently linked with application programs (which use some of those functions and data) to form executables.

The "Library", below, refers to any such software library or work which has been distributed under these terms. A "work based on the Library" means either the Library or any derivative work under copyright law: that is to say, a work containing the Library or a portion of it, either verbatim or with modifications and/or translated straightforwardly into another language. (Hereinafter, translation is included without limitation in the term "modification".)

"Source code" for a work means the preferred form of the work for making modifications to it. For a library, complete source code means all the source code for all modules it contains, plus any associated interface definition files, plus the scripts used to control compilation and installation of the library.

Activities other than copying, distribution and modification are not covered by this License; they are outside its scope. The act of running a program using the Library is not restricted, and output from such a program is covered only if its contents constitute a work based on the Library (independent of the use of the Library in a tool for writing it). Whether that is true depends on what the Library does and what the program that uses the Library does.

1. You may copy and distribute verbatim copies of the Library's complete source code as you receive it, in any medium, provided that you conspicuously and appropriately publish on each copy an appropriate copyright notice and disclaimer of warranty; keep intact all the notices that refer to this License and to the absence of any warranty; and distribute a copy of this License along with the Library.

You may charge a fee for the physical act of transferring a copy, and you may at your option offer warranty protection in exchange for a fee.

2. You may modify your copy or copies of the Library or any portion of it, thus forming a work based on the Library, and copy and distribute such modifications or work under the terms of Section 1 above, provided that you also meet all of these conditions:

a) The modified work must itself be a software library.

b) You must cause the files modified to carry prominent notices stating that you changed the files and the date of any change.

c) You must cause the whole of the work to be licensed at no charge to all third parties under the terms of this License.

d) If a facility in the modified Library refers to a function or a table of data to be supplied by an application program that uses the facility, other than as an argument passed when the facility is invoked, then you must make a good faith effort to ensure that, in the event an application does not supply such function or table, the facility still operates, and performs whatever part of its purpose remains meaningful.

(For example, a function in a library to compute square roots has a purpose that is entirely well-defined independent of the application. Therefore, Subsection 2d requires that any application-supplied function or table used by this function must be optional: if the application does not supply it, the square root function must still compute square roots.)

These requirements apply to the modified work as a whole. If identifiable sections of that work are not derived from the Library, and can be reasonably considered independent and separate works in themselves, then this License, and its terms, do not apply to those sections when you distribute them as separate works. But when you distribute the same sections as part of a whole which is a work based on the Library, the distribution of the whole must be on the terms of this License, whose permissions for other licensees extend to the entire whole, and thus to each and every part regardless of who wrote it.

Thus, it is not the intent of this section to claim rights or contest your rights to work written entirely by you; rather, the intent is to exercise the right to control the distribution of derivative or collective works based on the Library.

In addition, mere aggregation of another work not based on the Library with the Library (or with a work based on the Library) on a volume of a storage or distribution medium does not bring the other work under the scope of this License.

3. You may opt to apply the terms of the ordinary GNU General Public License instead of this License to a given copy of the Library. To do this, you must alter all the notices that refer to this License, so that they refer to the ordinary GNU General Public License, version 2, instead of to this License. (If a newer version than version 2 of the ordinary GNU General Public License has appeared, then you can specify that version instead if you wish.) Do not make any other change in these notices.

Once this change is made in a given copy, it is irreversible for that copy, so the ordinary GNU General Public License applies to all subsequent copies and derivative works made from that copy.

This option is useful when you wish to copy part of the code of the Library into a program that is not a library.

4. You may copy and distribute the Library (or a portion or derivative of it, under Section 2) in object code or executable form under the terms of Sections 1 and 2 above provided that you accompany it with the complete corresponding machine-readable source code, which must be distributed under the terms of Sections 1 and 2 above on a medium customarily used for software interchange.

If distribution of object code is made by offering access to copy from a designated place, then offering equivalent access to copy the source code from the same place satisfies the requirement to distribute the source code, even though third parties are not compelled to copy the source along with the object code.

5. A program that contains no derivative of any portion of the Library, but is designed to work with the Library by being compiled or linked with it, is called a "work that uses the Library". Such a work, in isolation, is not a derivative work of the Library, and therefore falls outside the scope of this License.

However, linking a "work that uses the Library" with the Library creates an executable that is a derivative of the Library (because it contains portions of the Library), rather than a "work that uses the library". The executable is therefore covered by this License. Section 6 states terms for distribution of such executables.

When a "work that uses the Library" uses material from a header file that is part of the Library, the object code for the work may be a derivative work of the Library even though the source code is not. Whether this is true is especially significant if the work can be linked without the Library, or if the work is itself a library. The threshold for this to be true is not precisely defined by law.

If such an object file uses only numerical parameters, data structure layouts and accessors, and small macros and small inline functions (ten lines or less in length), then the use of the object file is unrestricted, regardless of whether it is legally a derivative work. (Executables containing this object code plus portions of the Library will still fall under Section 6.)

Otherwise, if the work is a derivative of the Library, you may distribute the object code for the work under the terms of Section 6. Any executables containing that work also fall under Section 6, whether or not they are linked directly with the Library itself.

6. As an exception to the Sections above, you may also combine or link a "work that uses the Library" with the Library to produce a work containing portions of the Library, and distribute that work under terms of your choice, provided that the terms permit modification of the work for the customer's own use and reverse engineering for debugging such modifications.

You must give prominent notice with each copy of the work that the Library is used in it and that the Library and its use are covered by this License. You must supply a copy of this License. If the work during execution displays copyright notices, you must include the copyright notice for the Library among them, as well as a reference directing the user to the copy of this License. Also, you must do one of these things:

- a) Accompany the work with the complete corresponding machine-readable source code for the Library including whatever changes were used in the work (which must be distributed under Sections 1 and 2 above); and, if the work is an executable linked with the Library, with the complete machine-readable "work that uses the Library", as object code and/or source code, so that the user can modify the Library and then relink to produce a modified executable containing the modified Library. (It is understood that the user who changes the contents of definitions files in the Library will not necessarily be able to recompile the application to use the modified definitions.)
- b) Use a suitable shared library mechanism for linking with the Library. A suitable mechanism is one that (1) uses at run time a copy of the library already present on the user's computer system, rather than copying library functions into the executable, and (2) will operate properly with a modified version of the library, if the user installs one, as long as the modified version is interface-compatible with the version that the work was made with.
- c) Accompany the work with a written offer, valid for at least three years, to give the same user the materials specified in Subsection 6a, above, for a charge no more than the cost of performing this distribution.
- d) If distribution of the work is made by offering access to copy from a designated place, offer equivalent access to copy the above specified materials from the same place.
- e) Verify that the user has already received a copy of these materials or that you have already sent this user a copy.

For an executable, the required form of the "work that uses the Library" must include any data and utility programs needed for reproducing the executable from it. However, as a special exception, the materials to be distributed need not include anything that is normally distributed (in either source or binary form) with the major components (compiler, kernel, and so on) of the operating system on which the executable runs, unless that component itself accompanies the executable.

It may happen that this requirement contradicts the license restrictions of other proprietary libraries that do not normally accompany the operating system. Such a contradiction means you cannot use both them and the Library together in an executable that you distribute.

7. You may place library facilities that are a work based on the Library side-by-side in a single library together with other library facilities not covered by this License, and distribute such a combined library, provided that the separate distribution of the work based on the Library and of the other library facilities is otherwise permitted, and provided that you do these two things:

a) Accompany the combined library with a copy of the same work based on the Library, uncombined with any other library facilities. This must be distributed under the terms of the Sections above.

b) Give prominent notice with the combined library of the fact that part of it is a work based on the Library, and explaining where to find the accompanying uncombined form of the same work.

8. You may not copy, modify, sublicense, link with, or distribute the Library except as expressly provided under this License. Any attempt otherwise to copy, modify, sublicense, link with, or distribute the Library is void, and will automatically terminate your rights under this License. However, parties who have received copies, or rights, from you under this License will not have their licenses terminated so long as such parties remain in full compliance.

9. You are not required to accept this License, since you have not signed it. However, nothing else grants you permission to modify or distribute the Library or its derivative works. These actions are prohibited by law if you do not accept this License. Therefore, by modifying or distributing the Library (or any work based on the Library), you indicate your acceptance of this License to do so, and all its terms and conditions for copying, distributing or modifying the Library or works based on it.

10. Each time you redistribute the Library (or any work based on the Library), the recipient automatically receives a license from the original licensor to copy, distribute, link with or modify the Library subject to these terms and conditions. You may not impose any further restrictions on the recipients' exercise of the rights granted herein. You are not responsible for enforcing compliance by third parties with this License.

11. If, as a consequence of a court judgment or allegation of patent infringement or for any other reason (not limited to patent issues), conditions are imposed on you (whether by court order, agreement or otherwise) that contradict the conditions of this License, they do not excuse you from the conditions of this License. If you cannot distribute so as to satisfy simultaneously your obligations under this License and any other pertinent obligations, then as a consequence you may not distribute the Library at all. For example, if a patent license would not permit royalty-free redistribution of the Library by all those who receive copies directly or indirectly through you, then the only way you could satisfy both it and this License would be to refrain entirely from distribution of the Library.

If any portion of this section is held invalid or unenforceable under any particular circumstance, the balance of the section is intended to apply, and the section as a whole is intended to apply in other circumstances.

It is not the purpose of this section to induce you to infringe any patents or other property right claims or to contest validity of any such claims; this section has the sole purpose of protecting the integrity of the free software distribution system which is implemented by public license practices. Many people have made generous contributions to the wide range of software distributed through that system in reliance on consistent application of that system; it is up to the author/donor to decide if he or she is willing to distribute software through any other system and a licensee cannot impose that choice.

This section is intended to make thoroughly clear what is believed to be a consequence of the rest of this License.

12. If the distribution and/or use of the Library is restricted in certain countries either by patents or by copyrighted interfaces, the original copyright holder who places the Library under this License may add an explicit geographical distribution limitation excluding those countries, so that distribution is permitted only in or among countries not thus excluded. In such case, this License incorporates the limitation as if written in the body of this License.

13. The Free Software Foundation may publish revised and/or new versions of the Lesser General Public License from time to time. Such new versions will be similar in spirit to the present version, but may differ in detail to address new problems or concerns.

Each version is given a distinguishing version number. If the Library specifies a version number of this License which applies to it and "any later version", you have the option of following the terms and conditions either of that version or of any later version published by the Free Software Foundation. If the Library does not specify a license version number, you may choose any version ever published by the Free Software Foundation.

14. If you wish to incorporate parts of the Library into other free programs whose distribution conditions are incompatible with these, write to the author to ask for permission. For software which is copyrighted by the Free Software Foundation, write to the Free Software Foundation; we sometimes make exceptions for this. Our decision will be guided by the two goals of preserving the free status of all derivatives of our free software and of promoting the sharing and reuse of software generally.

NO WARRANTY

15. BECAUSE THE LIBRARY IS LICENSED FREE OF CHARGE, THERE IS NO WARRANTY FOR THE LIBRARY, TO THE EXTENT PERMITTED BY APPLICABLE LAW. EXCEPT WHEN OTHERWISE STATED IN WRITING THE COPYRIGHT HOLDERS AND/OR OTHER PARTIES PROVIDE THE LIBRARY "AS IS" WITHOUT WARRANTY OF ANY KIND, EITHER EXPRESSED OR IMPLIED, INCLUDING, BUT NOT LIMITED TO, THE IMPLIED WARRANTIES OF MERCHANTABILITY AND FITNESS FOR A PARTICULAR PURPOSE. THE ENTIRE RISK AS TO THE QUALITY AND PERFORMANCE OF THE LIBRARY IS WITH YOU. SHOULD THE LIBRARY PROVE DEFECTIVE, YOU ASSUME THE COST OF ALL NECESSARY SERVICING, REPAIR OR CORRECTION.

16. IN NO EVENT UNLESS REQUIRED BY APPLICABLE LAW OR AGREED TO IN WRITING WILL ANY COPYRIGHT HOLDER, OR ANY OTHER PARTY WHO MAY MODIFY AND/OR REDISTRIBUTE THE LIBRARY AS PERMITTED ABOVE, BE LIABLE TO YOU FOR DAMAGES, INCLUDING ANY GENERAL, SPECIAL, INCIDENTAL OR CONSEQUENTIAL DAMAGES ARISING OUT OF THE USE OR INABILITY TO USE THE LIBRARY (INCLUDING BUT NOT LIMITED TO LOSS OF DATA OR DATA BEING RENDERED INACCURATE OR LOSSES SUSTAINED BY

YOU OR THIRD PARTIES OR A FAILURE OF THE LIBRARY TO OPERATE WITH ANY OTHER SOFTWARE), EVEN IF SUCH HOLDER OR OTHER PARTY HAS BEEN ADVISED OF THE POSSIBILITY OF SUCH DAMAGES.

END OF TERMS AND CONDITIONS

How to Apply These Terms to Your New Libraries

If you develop a new library, and you want it to be of the greatest possible use to the public, we recommend making it free software that everyone can redistribute and change. You can do so by permitting redistribution under these terms (or, alternatively, under the terms of the ordinary General Public License).

To apply these terms, attach the following notices to the library. It is safest to attach them to the start of each source file to most effectively convey the exclusion of warranty; and each file should have at least the "copyright" line and a pointer to where the full notice is found.

<one line to give the library's name and a brief idea of what it does.> Copyright (C) <year> <name of author>

This library is free software; you can redistribute it and/or modify it under the terms of the GNU Lesser General Public License as published by the Free Software Foundation; either version 2.1 of the License, or (at your option) any later version.

This library is distributed in the hope that it will be useful, but WITHOUT ANY WARRANTY; without even the implied warranty of MERCHANTABILITY or FITNESS FOR A PARTICULAR PURPOSE. See the GNU Lesser General Public License for more details.

You should have received a copy of the GNU Lesser General Public License along with this library; if not, write to the Free Software Foundation, Inc., 51 Franklin Street, Fifth Floor, Boston, MA 02110-1301 USA

Also add information on how to contact you by electronic and paper mail.

You should also get your employer (if you work as a programmer) or your school, if any, to sign a "copyright disclaimer" for the library, if necessary. Here is a sample; alter the names:

Yoyodyne, Inc., hereby disclaims all copyright interest in the library `Frob' (a library for tweaking knobs) written by James Random Hacker.

<signature of Ty Coon>, 1 April 1990
Ty Coon, President of Vice

That's all there is to it!

GNU GENERAL PUBLIC LICENSE

Version 3, 29 June 2007

Copyright (C) 2007 Free Software Foundation, Inc. <<http://fsf.org/>>

Everyone is permitted to copy and distribute verbatim copies of this license document, but changing it is not allowed.

Preamble

The GNU General Public License is a free, copyleft license for software and other kinds of works.

The licenses for most software and other practical works are designed to take away your freedom to share and change the works. By contrast, the GNU General Public License is intended to guarantee your freedom to share and change all versions of a program--to make sure it remains free software for all its users. We, the Free Software Foundation, use the GNU General Public License for most of our software; it applies also to any other work released this way by its authors. You can apply it to your programs, too.

When we speak of free software, we are referring to freedom, not price. Our General Public Licenses are designed to make sure that you have the freedom to distribute copies of free software (and charge for them if you wish), that you receive source code or can get it if you want it, that you can change the software or use pieces of it in new free programs, and that you know you can do these things.

To protect your rights, we need to prevent others from denying you these rights or asking you to surrender the rights. Therefore, you have certain responsibilities if you distribute copies of the software, or if you modify it: responsibilities to respect the freedom of others.

For example, if you distribute copies of such a program, whether gratis or for a fee, you must pass on to the recipients the same freedoms that you received. You must make sure that they, too, receive or can get the source code. And you must show them these terms so they know their rights.

Developers that use the GNU GPL protect your rights with two steps:

(1) assert copyright on the software, and (2) offer you this License giving you legal permission to copy, distribute and/or modify it.

For the developers' and authors' protection, the GPL clearly explains that there is no warranty for this free software. For both users' and authors' sake, the GPL requires that modified versions be marked as changed, so that their problems will not be attributed erroneously to authors of previous versions.

Some devices are designed to deny users access to install or run modified versions of the software inside them, although the manufacturer can do so. This is fundamentally incompatible with the aim of protecting users' freedom to change the software. The systematic pattern of such abuse occurs in the area of products for individuals to use, which is precisely where it is most unacceptable. Therefore, we have designed this version of the GPL to prohibit the practice for those products. If such problems arise substantially in other domains, we stand ready to extend this provision to those domains in future versions of the GPL, as needed to protect the freedom of users.

Finally, every program is threatened constantly by software patents. States should not allow patents to restrict development and use of software on general-purpose computers, but in those that do, we wish to avoid the special danger that patents applied to a free program could make it effectively proprietary. To prevent this, the GPL assures that patents cannot be used to render the program non-free.

The precise terms and conditions for copying, distribution and modification follow.

TERMS AND CONDITIONS

0. Definitions.

"This License" refers to version 3 of the GNU General Public License.

"Copyright" also means copyright-like laws that apply to other kinds of works, such as semiconductor masks.

"The Program" refers to any copyrightable work licensed under this License. Each licensee is addressed as "you". "Licensees" and "recipients" may be individuals or organizations.

To "modify" a work means to copy from or adapt all or part of the work in a fashion requiring copyright permission, other than the making of an exact copy. The resulting work is called a "modified version" of the earlier work or a work "based on" the earlier work.

A "covered work" means either the unmodified Program or a work based on the Program.

To "propagate" a work means to do anything with it that, without permission, would make you directly or secondarily liable for infringement under applicable copyright law, except executing it on a computer or modifying a private copy. Propagation includes copying, distribution (with or without modification), making available to the public, and in some countries other activities as well.

To "convey" a work means any kind of propagation that enables other parties to make or receive copies. Mere interaction with a user through a computer network, with no transfer of a copy, is not conveying.

An interactive user interface displays "Appropriate Legal Notices" to the extent that it includes a convenient and prominently visible feature that (1) displays an appropriate copyright notice, and (2) tells the user that there is no warranty for the work (except to the extent that warranties are provided), that licensees may convey the work under this License, and how to view a copy of this License. If the interface presents a list of user commands or options, such as a menu, a prominent item in the list meets this criterion.

1. Source Code.

The "source code" for a work means the preferred form of the work for making modifications to it. "Object code" means any non-source form of a work.

A "Standard Interface" means an interface that either is an official standard defined by a recognized standards body, or, in the case of interfaces specified for a particular programming language, one that is widely used among developers working in that language.

The "System Libraries" of an executable work include anything, other than the work as a whole, that (a) is included in the normal form of packaging a Major Component, but which is not part of that Major Component, and (b) serves only to enable use of the work with that Major Component, or to implement a Standard Interface for which an implementation is available to the public in source code form. A "Major Component", in this context, means a major essential component (kernel, window system, and so on) of the specific operating system (if any) on which the executable work runs, or a compiler used to produce the work, or an object code interpreter used to run it.

The "Corresponding Source" for a work in object code form means all the source code needed to generate, install, and (for an executable work) run the object code and to modify the work, including scripts to control those activities. However, it does not include the work's System Libraries, or general-purpose tools or generally available free programs which are used unmodified in performing those activities but which are not part of the work. For example, Corresponding Source includes interface definition files associated with source files for the work, and the source code for shared libraries and dynamically linked subprograms that the work is specifically designed to require, such as by intimate data communication or control flow between those subprograms and other parts of the work.

The Corresponding Source need not include anything that users can regenerate automatically from other parts of the Corresponding Source.

The Corresponding Source for a work in source code form is that same work.

2. Basic Permissions.

All rights granted under this License are granted for the term of copyright on the Program, and are irrevocable provided the stated conditions are met. This License explicitly affirms your unlimited permission to run the unmodified Program. The output from running a covered work is covered by this License only if the output, given its content, constitutes a covered work. This License acknowledges your rights of fair use or other equivalent, as provided by copyright law.

You may make, run and propagate covered works that you do not convey, without conditions so long as your license otherwise remains in force. You may convey covered works to others for the sole purpose of having them make modifications exclusively for you, or provide you with facilities for running those works, provided that you comply with the terms of this License in conveying all material for which you do not control copyright. Those thus making or running the covered works for you must do so exclusively on your behalf, under your direction and control, on terms that prohibit them from making any copies of your copyrighted material outside their relationship with you.

Conveying under any other circumstances is permitted solely under the conditions stated below. Sublicensing is not allowed; section 10 makes it unnecessary.

3. Protecting Users' Legal Rights From Anti-Circumvention Law.

No covered work shall be deemed part of an effective technological measure under any applicable law fulfilling obligations under article 11 of the WIPO copyright treaty adopted on 20 December 1996, or similar laws prohibiting or restricting circumvention of such measures.

When you convey a covered work, you waive any legal power to forbid circumvention of technological measures to the extent such circumvention is effected by exercising rights under this License with respect to the covered work, and you disclaim any intention to limit operation or modification of the work as a means of enforcing, against the work's users, your or third parties' legal rights to forbid circumvention of technological measures.

4. Conveying Verbatim Copies.

You may convey verbatim copies of the Program's source code as you receive it, in any medium, provided that you conspicuously and appropriately publish on each copy an appropriate copyright notice; keep intact all notices stating that this License and any non-permissive terms added in accord with section 7 apply to the code; keep intact all notices of the absence of any warranty; and give all recipients a copy of this License along with the Program.

You may charge any price or no price for each copy that you convey, and you may offer support or warranty protection for a fee.

5. Conveying Modified Source Versions.

You may convey a work based on the Program, or the modifications to produce it from the Program, in the form of source code under the terms of section 4, provided that you also meet all of these conditions:

a) The work must carry prominent notices stating that you modified it, and giving a relevant date.

b) The work must carry prominent notices stating that it is released under this License and any conditions added under section

7. This requirement modifies the requirement in section 4 to "keep intact all notices".

c) You must license the entire work, as a whole, under this License to anyone who comes into possession of a copy. This License will therefore apply, along with any applicable section 7 additional terms, to the whole of the work, and all its parts, regardless of how they are packaged. This License gives no permission to license the work in any other way, but it does not invalidate such permission if you have separately received it.

d) If the work has interactive user interfaces, each must display Appropriate Legal Notices; however, if the Program has interactive interfaces that do not display Appropriate Legal Notices, your work need not make them do so.

A compilation of a covered work with other separate and independent works, which are not by their nature extensions of the covered work, and which are not combined with it such as to form a larger program, in or on a volume of a storage or distribution medium, is called an "aggregate" if the compilation and its resulting copyright are not used to limit the access or legal rights of the compilation's users beyond what the individual works permit. Inclusion of a covered work in an aggregate does not cause this License to apply to the other parts of the aggregate.

6. Conveying Non-Source Forms.

You may convey a covered work in object code form under the terms of sections 4 and 5, provided that you also convey the machine-readable Corresponding Source under the terms of this License, in one of these ways:

a) Convey the object code in, or embodied in, a physical product (including a physical distribution medium), accompanied by the Corresponding Source fixed on a durable physical medium customarily used for software interchange.

b) Convey the object code in, or embodied in, a physical product (including a physical distribution medium), accompanied by a written offer, valid for at least three years and valid for as long as you offer spare parts or customer support for that product model, to give anyone who possesses the object code either (1) a copy of the Corresponding Source for all the software in the product that is covered by this License, on a durable physical medium customarily used for software interchange, for a price no more than your reasonable cost of physically performing this conveying of source, or (2) access to copy the Corresponding Source from a network server at no charge.

c) Convey individual copies of the object code with a copy of the written offer to provide the Corresponding Source. This alternative is allowed only occasionally and noncommercially, and only if you received the object code with such an offer, in accord with subsection 6b.

d) Convey the object code by offering access from a designated place (gratis or for a charge), and offer equivalent access to the Corresponding Source in the same way through the same place at no further charge. You need not require recipients to copy the Corresponding Source along with the object code. If the place to copy the object code is a network server, the Corresponding Source may be on a different server (operated by you or a third party) that supports equivalent copying facilities, provided you maintain clear directions next to the object code saying where to find the Corresponding Source. Regardless of what server hosts the Corresponding Source, you remain obligated to ensure that it is available for as long as needed to satisfy these requirements.

e) Convey the object code using peer-to-peer transmission, provided you inform other peers where the object code and Corresponding Source of the work are being offered to the general public at no charge under subsection 6d.

A separable portion of the object code, whose source code is excluded from the Corresponding Source as a System Library, need not be included in conveying the object code work.

A "User Product" is either (1) a "consumer product", which means any tangible personal property which is normally used for personal, family, or household purposes, or (2) anything designed or sold for incorporation into a dwelling. In determining whether a product is a consumer product, doubtful cases shall be resolved in favor of coverage. For a particular product received by a particular user, "normally used" refers to a typical or common use of that class of product, regardless of the status of the particular user or of the way in which the particular user actually uses, or expects or is expected to use, the product. A product is a consumer product regardless of whether the product has substantial commercial, industrial or non-consumer uses, unless such uses represent the only significant mode of use of the product.

"Installation Information" for a User Product means any methods, procedures, authorization keys, or other information required to install and execute modified versions of a covered work in that User Product from a modified version of its

Corresponding Source. The information must suffice to ensure that the continued functioning of the modified object code is in no case prevented or interfered with solely because modification has been made.

If you convey an object code work under this section in, or with, or specifically for use in, a User Product, and the conveying occurs as part of a transaction in which the right of possession and use of the User Product is transferred to the recipient in perpetuity or for a fixed term (regardless of how the transaction is characterized), the Corresponding Source conveyed under this section must be accompanied by the Installation Information. But this requirement does not apply if neither you nor any third party retains the ability to install modified object code on the User Product (for example, the work has been installed in ROM).

The requirement to provide Installation Information does not include a requirement to continue to provide support service, warranty, or updates for a work that has been modified or installed by the recipient, or for the User Product in which it has been modified or installed. Access to a network may be denied when the modification itself materially and adversely affects the operation of the network or violates the rules and protocols for communication across the network.

Corresponding Source conveyed, and Installation Information provided, in accord with this section must be in a format that is publicly documented (and with an implementation available to the public in source code form), and must require no special password or key for unpacking, reading or copying.

7. Additional Terms.

"Additional permissions" are terms that supplement the terms of this License by making exceptions from one or more of its conditions. Additional permissions that are applicable to the entire Program shall be treated as though they were included in this License, to the extent that they are valid under applicable law. If additional permissions apply only to part of the Program, that part may be used separately under those permissions, but the entire Program remains governed by this License without regard to the additional permissions.

When you convey a copy of a covered work, you may at your option remove any additional permissions from that copy, or from any part of it. (Additional permissions may be written to require their own removal in certain cases when you modify the work.) You may place additional permissions on material, added by you to a covered work, for which you have or can give appropriate copyright permission.

Notwithstanding any other provision of this License, for material you add to a covered work, you may (if authorized by the copyright holders of that material) supplement the terms of this License with terms:

- a) Disclaiming warranty or limiting liability differently from the terms of sections 15 and 16 of this License; or
- b) Requiring preservation of specified reasonable legal notices or author attributions in that material or in the Appropriate Legal Notices displayed by works containing it; or
- c) Prohibiting misrepresentation of the origin of that material, or requiring that modified versions of such material be marked in reasonable ways as different from the original version; or
- d) Limiting the use for publicity purposes of names of licensors or authors of the material; or
- e) Declining to grant rights under trademark law for use of some trade names, trademarks, or service marks; or
- f) Requiring indemnification of licensors and authors of that material by anyone who conveys the material (or modified versions of it) with contractual assumptions of liability to the recipient, for any liability that these contractual assumptions directly impose on those licensors and authors.

All other non-permissive additional terms are considered "further restrictions" within the meaning of section 10. If the Program as you received it, or any part of it, contains a notice stating that it is governed by this License along with a term that is a further restriction, you may remove that term. If a license document contains a further restriction but permits

relicensing or conveying under this License, you may add to a covered work material governed by the terms of that license document, provided that the further restriction does not survive such relicensing or conveying.

If you add terms to a covered work in accord with this section, you must place, in the relevant source files, a statement of the additional terms that apply to those files, or a notice indicating where to find the applicable terms.

Additional terms, permissive or non-permissive, may be stated in the form of a separately written license, or stated as exceptions; the above requirements apply either way.

8. Termination.

You may not propagate or modify a covered work except as expressly provided under this License. Any attempt otherwise to propagate or modify it is void, and will automatically terminate your rights under this License (including any patent licenses granted under the third paragraph of section 11).

However, if you cease all violation of this License, then your license from a particular copyright holder is reinstated (a) provisionally, unless and until the copyright holder explicitly and finally terminates your license, and (b) permanently, if the copyright holder fails to notify you of the violation by some reasonable means prior to 60 days after the cessation.

Moreover, your license from a particular copyright holder is reinstated permanently if the copyright holder notifies you of the violation by some reasonable means, this is the first time you have received notice of violation of this License (for any work) from that copyright holder, and you cure the violation prior to 30 days after your receipt of the notice.

Termination of your rights under this section does not terminate the licenses of parties who have received copies or rights from you under this License. If your rights have been terminated and not permanently reinstated, you do not qualify to receive new licenses for the same material under section 10.

9. Acceptance Not Required for Having Copies.

You are not required to accept this License in order to receive or run a copy of the Program. Ancillary propagation of a covered work occurring solely as a consequence of using peer-to-peer transmission to receive a copy likewise does not require acceptance. However, nothing other than this License grants you permission to propagate or modify any covered work. These actions infringe copyright if you do not accept this License. Therefore, by modifying or propagating a covered work, you indicate your acceptance of this License to do so.

10. Automatic Licensing of Downstream Recipients.

Each time you convey a covered work, the recipient automatically receives a license from the original licensors, to run, modify and propagate that work, subject to this License. You are not responsible for enforcing compliance by third parties with this License.

An "entity transaction" is a transaction transferring control of an organization, or substantially all assets of one, or subdividing an organization, or merging organizations. If propagation of a covered work results from an entity transaction, each party to that transaction who receives a copy of the work also receives whatever licenses to the work the party's predecessor in interest had or could give under the previous paragraph, plus a right to possession of the Corresponding Source of the work from the predecessor in interest, if the predecessor has it or can get it with reasonable efforts.

You may not impose any further restrictions on the exercise of the rights granted or affirmed under this License. For example, you may not impose a license fee, royalty, or other charge for exercise of rights granted under this License, and you may not initiate litigation (including a cross-claim or counterclaim in a lawsuit) alleging that any patent claim is infringed by making, using, selling, offering for sale, or importing the Program or any portion of it.

11. Patents.

A "contributor" is a copyright holder who authorizes use under this License of the Program or a work on which the Program is based. The work thus licensed is called the contributor's "contributor version".

A contributor's "essential patent claims" are all patent claims owned or controlled by the contributor, whether already acquired or hereafter acquired, that would be infringed by some manner, permitted by this License, of making, using, or selling its contributor version, but do not include claims that would be infringed only as a consequence of further modification of the contributor version. For purposes of this definition, "control" includes the right to grant patent sublicenses in a manner consistent with the requirements of this License.

Each contributor grants you a non-exclusive, worldwide, royalty-free patent license under the contributor's essential patent claims, to make, use, sell, offer for sale, import and otherwise run, modify and propagate the contents of its contributor version.

In the following three paragraphs, a "patent license" is any express agreement or commitment, however denominated, not to enforce a patent (such as an express permission to practice a patent or covenant not to sue for patent infringement). To "grant" such a patent license to a party means to make such an agreement or commitment not to enforce a patent against the party.

If you convey a covered work, knowingly relying on a patent license, and the Corresponding Source of the work is not available for anyone to copy, free of charge and under the terms of this License, through a publicly available network server or other readily accessible means, then you must either (1) cause the Corresponding Source to be so available, or (2) arrange to deprive yourself of the benefit of the patent license for this particular work, or (3) arrange, in a manner consistent with the requirements of this License, to extend the patent license to downstream recipients. "Knowingly relying" means you have actual knowledge that, but for the patent license, your conveying the covered work in a country, or your recipient's use of the covered work in a country, would infringe one or more identifiable patents in that country that you have reason to believe are valid.

If, pursuant to or in connection with a single transaction or arrangement, you convey, or propagate by procuring conveyance of, a covered work, and grant a patent license to some of the parties receiving the covered work authorizing them to use, propagate, modify or convey a specific copy of the covered work, then the patent license you grant is automatically extended to all recipients of the covered work and works based on it.

A patent license is "discriminatory" if it does not include within the scope of its coverage, prohibits the exercise of, or is conditioned on the non-exercise of one or more of the rights that are specifically granted under this License. You may not convey a covered work if you are a party to an arrangement with a third party that is in the business of distributing software, under which you make payment to the third party based on the extent of your activity of conveying the work, and under which the third party grants, to any of the parties who would receive the covered work from you, a discriminatory patent license (a) in connection with copies of the covered work conveyed by you (or copies made from those copies), or (b) primarily for and in connection with specific products or compilations that contain the covered work, unless you entered into that arrangement, or that patent license was granted, prior to 28 March 2007.

Nothing in this License shall be construed as excluding or limiting any implied license or other defenses to infringement that may otherwise be available to you under applicable patent law.

12. No Surrender of Others' Freedom.

If conditions are imposed on you (whether by court order, agreement or otherwise) that contradict the conditions of this License, they do not excuse you from the conditions of this License. If you cannot convey a covered work so as to satisfy simultaneously your obligations under this License and any other pertinent obligations, then as a consequence you may not convey it at all. For example, if you agree to terms that obligate you to collect a royalty for further conveying from those to whom you convey the Program, the only way you could satisfy both those terms and this License would be to refrain entirely from conveying the Program.

13. Use with the GNU Affero General Public License.

Notwithstanding any other provision of this License, you have permission to link or combine any covered work with a work licensed under version 3 of the GNU Affero General Public License into a single combined work, and to convey the resulting work. The terms of this License will continue to apply to the part which is the covered work, but the special requirements of the GNU Affero General Public License, section 13, concerning interaction through a network will apply to the combination as such.

14. Revised Versions of this License.

The Free Software Foundation may publish revised and/or new versions of the GNU General Public License from time to time. Such new versions will be similar in spirit to the present version, but may differ in detail to address new problems or concerns.

Each version is given a distinguishing version number. If the Program specifies that a certain numbered version of the GNU General Public License "or any later version" applies to it, you have the option of following the terms and conditions either of that numbered version or of any later version published by the Free Software Foundation. If the Program does not specify a version number of the GNU General Public License, you may choose any version ever published by the Free Software Foundation.

If the Program specifies that a proxy can decide which future versions of the GNU General Public License can be used, that proxy's public statement of acceptance of a version permanently authorizes you to choose that version for the Program.

Later license versions may give you additional or different permissions. However, no additional obligations are imposed on any author or copyright holder as a result of your choosing to follow a later version.

15. Disclaimer of Warranty.

THERE IS NO WARRANTY FOR THE PROGRAM, TO THE EXTENT PERMITTED BY APPLICABLE LAW. EXCEPT WHEN OTHERWISE STATED IN WRITING THE COPYRIGHT HOLDERS AND/OR OTHER PARTIES PROVIDE THE PROGRAM "AS IS" WITHOUT WARRANTY OF ANY KIND, EITHER EXPRESSED OR IMPLIED, INCLUDING, BUT NOT LIMITED TO, THE IMPLIED WARRANTIES OF MERCHANTABILITY AND FITNESS FOR A PARTICULAR PURPOSE. THE ENTIRE RISK AS TO THE QUALITY AND PERFORMANCE OF THE PROGRAM IS WITH YOU. SHOULD THE PROGRAM PROVE DEFECTIVE, YOU ASSUME THE COST OF ALL NECESSARY SERVICING, REPAIR OR CORRECTION.

16. Limitation of Liability.

IN NO EVENT UNLESS REQUIRED BY APPLICABLE LAW OR AGREED TO IN WRITING WILL ANY COPYRIGHT HOLDER, OR ANY OTHER PARTY WHO MODIFIES AND/OR CONVEYS THE PROGRAM AS PERMITTED ABOVE, BE LIABLE TO YOU FOR DAMAGES, INCLUDING ANY GENERAL, SPECIAL, INCIDENTAL OR CONSEQUENTIAL DAMAGES ARISING OUT OF THE USE OR INABILITY TO USE THE PROGRAM (INCLUDING BUT NOT LIMITED TO LOSS OF DATA OR DATA BEING RENDERED INACCURATE OR LOSSES SUSTAINED BY YOU OR THIRD PARTIES OR A FAILURE OF THE PROGRAM TO OPERATE WITH ANY OTHER PROGRAMS), EVEN IF SUCH HOLDER OR OTHER PARTY HAS BEEN ADVISED OF THE POSSIBILITY OF SUCH DAMAGES.

17. Interpretation of Sections 15 and 16.

If the disclaimer of warranty and limitation of liability provided above cannot be given local legal effect according to their terms, reviewing courts shall apply local law that most closely approximates an absolute waiver of all civil liability in connection with the Program, unless a warranty or assumption of liability accompanies a copy of the Program in return for a fee.

END OF TERMS AND CONDITIONS

How to Apply These Terms to Your New Programs

If you develop a new program, and you want it to be of the greatest possible use to the public, the best way to achieve this is to make it free software which everyone can redistribute and change under these terms.

To do so, attach the following notices to the program. It is safest to attach them to the start of each source file to most effectively state the exclusion of warranty; and each file should have at least the "copyright" line and a pointer to where the full notice is found.

```
<one line to give the program's name and a brief idea of what it does.>  
Copyright (C) <year> <name of author>
```

This program is free software: you can redistribute it and/or modify it under the terms of the GNU General Public License as published by the Free Software Foundation, either version 3 of the License, or (at your option) any later version.

This program is distributed in the hope that it will be useful, but WITHOUT ANY WARRANTY; without even the implied warranty of MERCHANTABILITY or FITNESS FOR A PARTICULAR PURPOSE. See the GNU General Public License for more details.

You should have received a copy of the GNU General Public License along with this program. If not, see <http://www.gnu.org/licenses/>.

Also add information on how to contact you by electronic and paper mail.

If the program does terminal interaction, make it output a short notice like this when it starts in an interactive mode:

```
<program> Copyright (C) <year> <name of author>  
This program comes with ABSOLUTELY NO WARRANTY; for details type `show w'.  
This is free software, and you are welcome to redistribute it under certain conditions; type `show c' for details.
```

The hypothetical commands `show w' and `show c' should show the appropriate parts of the General Public License. Of course, your program's commands might be different; for a GUI interface, you would use an "about box".

You should also get your employer (if you work as a programmer) or school, if any, to sign a "copyright disclaimer" for the program, if necessary.

For more information on this, and how to apply and follow the GNU GPL, see <http://www.gnu.org/licenses/>.

The GNU General Public License does not permit incorporating your program into proprietary programs. If your program is a subroutine library, you may consider it more useful to permit linking proprietary applications with the library. If this is what you want to do, use the GNU Lesser General Public License instead of this License. But first, please read <http://www.gnu.org/philosophy/why-not-lgpl.html>.

-----libtiff-----

Copyright (c) 1988-1997 Sam Leffler
Copyright (c) 1991-1997 Silicon Graphics, Inc.

Permission to use, copy, modify, distribute, and sell this software and its documentation for any purpose is hereby granted without fee, provided that (i) the above copyright notices and this permission notice appear in all copies of the software and related documentation, and (ii) the names of Sam Leffler and Silicon Graphics may not be used in any advertising or publicity relating to the software without the specific, prior written permission of Sam Leffler and Silicon Graphics.

THE SOFTWARE IS PROVIDED "AS-IS" AND WITHOUT WARRANTY OF ANY KIND, EXPRESS, IMPLIED OR OTHERWISE, INCLUDING WITHOUT LIMITATION, ANY WARRANTY OF MERCHANTABILITY OR FITNESS FOR A PARTICULAR PURPOSE.

IN NO EVENT SHALL SAM LEFFLER OR SILICON GRAPHICS BE LIABLE FOR ANY SPECIAL, INCIDENTAL, INDIRECT OR CONSEQUENTIAL DAMAGES OF ANY KIND, OR ANY DAMAGES WHATSOEVER RESULTING FROM LOSS OF USE, DATA OR PROFITS, WHETHER OR NOT ADVISED OF THE POSSIBILITY OF DAMAGE, AND ON ANY THEORY OF LIABILITY, ARISING OUT OF OR IN CONNECTION WITH THE USE OR PERFORMANCE OF THIS SOFTWARE.

-----libjpeg-----

This software is based in part on the work of the Independent JPEG Group.

SOFTWARE LICENSE

PLEASE READ THIS LICENSE CAREFULLY BEFORE USING THE SOFTWARE. BY USING THE SOFTWARE, YOU ARE AGREEING TO BE BOUND BY THE TERMS OF THIS LICENSE.

1. License

The application, demonstration, system and other software accompanying this License, whether on disk, in read only memory, or on any other media (the "Software") and related documentation are licensed to you by SHARP. You own the disk on which the Software is recorded but SHARP and/or SHARP's Licensors retain title to the Software and related documentation. This License allows you to use the Software on one or more computers connected to a single printer and make one copy of the Software in machine-readable form for backup purposes only. You must reproduce on such copy the SHARP copyright notice, the copyright notice of SHARP's Licensors and any other proprietary legends of SHARP and/or its Licensors that were on the original copy of the Software. You may also transfer all your license rights in the Software, the backup copy of the Software, the related documentation and a copy of this License to another party, provided the other party reads and agrees to the terms and conditions of this License.

2. Restrictions

The Software contains copyrighted material, trade secrets and other proprietary material which is owned by SHARP and/or its Licensors and in order to protect them you may not decompile, reverse engineer, disassemble or otherwise reduce the Software to a human-perceivable form. You may not modify, network, rent, lease, loan, distribute or create derivative works based upon the Software in whole or in part. You may not electronically transmit the Software from one computer to another or over a network.

3. Termination

This license is effective until terminated. You may terminate this License at any time by destroying the Software and related documentation and all copies thereof. This License will terminate immediately without notice from SHARP and/or SHARP's Licensors if you fail to comply with any provision of this License. Upon termination you must destroy the Software and related documentation and all copies thereof.

4. Export Law Assurances

You agree and certify that neither the Software nor any other technical data received from SHARP, nor the direct product thereof, will be exported outside the United States except as authorized and as permitted by the laws and regulations of the United States. If the Software has been rightfully obtained by you outside of the United States, you agree that you will not re-export the Software nor any other technical data received from SHARP, nor the direct product thereof, except as permitted by the laws and regulations of the United States and the laws and the regulation of the jurisdiction in which you obtained the Software.

5. Government End Users

If you are acquiring the Software on behalf of any unit or agency of the United States Government, the following provisions apply. The Government agrees:

- (i) if the Software is supplied to the Department of Defense (DoD), the Software is classified as "Commercial Computer Software" and the Government is acquiring only "restricted rights" in the Software and its documentation as that term is defined in Clause 252.227-7013 (c)(1) (Oct., 1988) of the DFARS; and
- (ii) if the Software is supplied to any unit or agency of the United States Government other than DoD, the Software is classified as "Commercial" that term is defined at 48 C.F.R. 2.101 and as "Commercial Computer Software" that term is defined in 48 C.F.R. 12.212, and the Government's rights in the Software and its documentation will be as defined in Clause 52.227-19 (c)(2) of the FAR or, in the case of NASA, in Clause 18-52.227-86 (d) of the NASA Supplement to the FAR.

6. Limited Warranty on Media.

SHARP warrants the disks on which the Software is recorded to be free from defects in materials and workmanship under normal use for a period of ninety (90) days from the date of purchase as evidenced by a copy of the receipt. The entire liability of SHARP and/or its Licensors and your exclusive remedy will be replacement of the disk which fails to meet the limited warranty provided by this Clause 6. A disk will be replaced when it is returned to SHARP or a SHARP authorized representative with a copy of the receipt. SHARP will have no responsibility to replace a disk damaged by accident, abuse or misapplication.

ANY IMPLIED WARRANTIES ON THE DISKS, INCLUDING THE IMPLIED WARRANTIES OF MERCHANTABILITY AND FITNESS FOR A PARTICULAR PURPOSE, ARE LIMITED IN DURATION TO NINETY (90) DAYS FROM THE DATE OF DELIVERY. THIS WARRANTY GIVES YOU SPECIFIC LEGAL RIGHTS, AND YOU MAY ALSO HAVE OTHER RIGHTS WHICH VARY FROM JURISDICTION TO JURISDICTION.

7. Disclaimer of Warranty on Software

You expressly acknowledge and agree that use of the Software is at your sole risk. The Software and related documentation are provided "AS IS" and without warranty of any kind and SHARP and SHARP's Licensor(s) (for the purpose of provisions 6 and 7, SHARP and SHARP's Licensor(s) shall be collectively referred to as "SHARP") EXPRESSLY DISCLAIM ALL WARRANTIES, EXPRESS OR IMPLIED, INCLUDING, BUT NOT LIMITED TO, THE IMPLIED WARRANTIES OF MERCHANTABILITY AND FITNESS FOR A PARTICULAR PURPOSE. SHARP DOES NOT WARRANT THAT THE FUNCTIONS CONTAINED IN THE SOFTWARE WILL MEET YOUR REQUIREMENTS, OR THAT THE OPERATION OF THE SOFTWARE WILL BE UNINTERRUPTED OR ERROR-FREE, OR THAT DEFECTS IN THE SOFTWARE WILL BE CORRECTED. FURTHERMORE, SHARP DOES NOT WARRANT OR MAKE ANY REPRESENTATIONS REGARDING THE USE OR THE RESULTS OF THE USE OF THE SOFTWARE OR RELATED DOCUMENTATION IN TERMS OF THEIR CORRECTNESS, ACCURACY, RELIABILITY, OR OTHERWISE. NO ORAL OR WRITTEN INFORMATION OR ADVICE GIVEN BY SHARP OR A SHARP AUTHORIZED REPRESENTATIVE SHALL CREATE A WARRANTY OR IN ANY WAY INCREASE THE SCOPE OF THIS WARRANTY. SHOULD THE SOFTWARE PROVE DEFECTIVE, YOU (AND NOT SHARP OR A SHARP AUTHORIZED REPRESENTATIVE) ASSUME THE ENTIRE COST OF ALL NECESSARY SERVICING, REPAIR OR CORRECTION, SOME JURISDICTIONS DO NOT ALLOW THE EXCLUSION OF IMPLIED WARRANTIES, SO THE ABOVE EXCLUSION MAY NOT APPLY TO YOU.

8. Limitation of Liability

UNDER NO CIRCUMSTANCES INCLUDING NEGLIGENCE, SHALL SHARP BE LIABLE FOR ANY INCIDENTAL, SPECIAL OR CONSEQUENTIAL DAMAGES THAT RESULT FROM THE USE OR INABILITY TO USE THE SOFTWARE OR RELATED DOCUMENTATION, EVEN IF SHARP OR A SHARP AUTHORIZED REPRESENTATIVE HAS BEEN ADVISED OF THE POSSIBILITY OF SUCH DAMAGES. SOME JURISDICTIONS DO NOT ALLOW THE LIMITATION OR EXCLUSION OF LIABILITY FOR INCIDENTAL OR CONSEQUENTIAL DAMAGES SO THE ABOVE LIMITATION OR EXCLUSION MAY NOT APPLY TO YOU.

In no event shall SHARP's total liability to you for all damages, losses, and causes of action (whether in contract, tort (including negligence) or otherwise) exceed the amount paid by you for the Software.

9. Controlling Law and Severability

For a portion of the Software related with Apple Macintosh and Microsoft Windows, this license shall be governed by and construed in accordance with the laws of the state of California and Washington, respectively. If for any reason a court of competent jurisdiction finds any provision of this License, or portion thereof, to be unenforceable, that provision of the License shall be enforced to the maximum extent permissible so as to effect the intent of the parties, and the remainder of this License shall continue in full force and effect.

10. Complete Agreement

This License constitutes the entire agreement between the parties with respect to the use of the Software and related documentation, and supersedes all prior or contemporaneous understandings or agreements, written or oral, regarding such subject matter. No amendment to or modification of this License will be binding unless in writing and signed by a duly authorized representative of SHARP.

SHARP[®]
SHARP CORPORATION